

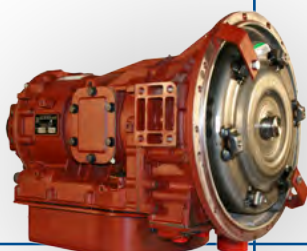
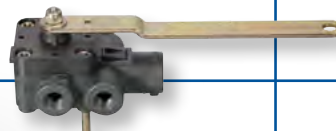
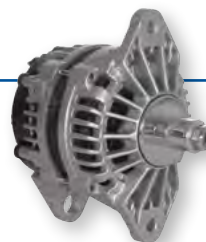


BUS PARTS[®]

BUS CATALOG



*Comprehensive parts
coverage for all brands
and models of buses.*





Tested. Reliable. Guaranteed.

TRP® Bus Parts

Choosing the right replacement part or service for your vehicle—whether you own one, or a fleet—is one of the most important decisions you can make for your business. And, with tested TRP® parts it's an easy decision.

Regardless of the make you drive, TRP® quality replacement parts are engineered to fit your truck, trailer or bus. Choose the parts that give you the best value for your business. Check them out at an approved TRP® retailer near you.

The cross reference information in this catalog is based upon data provided by several industry sources and our partners. While every attempt is made to ensure the information presented is accurate, we bear no liability due to incorrect or incomplete information.

Product Availability

Due to export restrictions and market demands, not all products are always available in every location. Check for availability in your area with your local TRP® Distributor.

No part of this marketing material may be reproduced in any manner without written permission from TRP® North America.

Chapters

1	Brakes.....	1 - 1
2	Wheels & Wheel End Hardware	2 - 1
3	Axles	3 - 1
4	Drivetrain.....	4 - 1
5	Steering.....	5 - 1
6	Suspension	6 - 1
7	Engine Kits.....	7 - 1
8	Air Systems.....	8 - 1
9	Emissions.....	9 - 1
10	Cold Weather	10 - 1
11	Transmissions	11 - 1
12	Filtration	12 - 1
13	Fluids	13 - 1
14	Seats.....	14 - 1
15	Electrical	15 - 1
16	Audio/Video.....	16 - 1
17	Lighting	17 - 1
18	HVAC	18 - 1
19	Glass.....	19 - 1
20	Mirrors.....	20 - 1
21	Safety.....	21 - 1

Indexes & Tables

Part Number Index	B - 1
Subject Index.....	B - 31
Tables	B - 33

TRP® North America

750 Houser Way N.
Renton, WA 98057

www.trpparts.com

TRP® BUS PARTS

TRP® Aftermarket Parts for trucks, trailers, and buses are available through a network of authorized retailers that include Kenworth, Peterbilt, and DAF dealerships around the world. From dump trucks to cement mixers, delivery vans to tractor-trailers, school buses to transit buses of any age, TRP® offers reliable aftermarket products that are designed and tested to not only meet OEM specifications, but to exceed customers' expectations regardless of which major manufacturer makes their vehicles.

CONFIDENCE FOR THE ROAD AHEAD

Drivers and their vehicles — from trucks, trailers and buses — are constantly being tested. Whether it's the elements — the schedule — or the terrain, you must be prepared. The TRP® line of parts and service is engineered to withstand those tests — and exceed them.

TRP® is dedicated to providing the reliability that drivers demand out of their vehicles. It's the partnership between tough parts and the roads that test them. It's a focus on extending the life of your vehicle, no matter the make, so you can get the most out of your truck, trailer or bus.

What the TRP® logo means to you is confidence. Confidence that you're covered, no matter your make or vehicle. Confidence that the job will get done. And the confidence to take on whatever test may wait around the next turn.

Don't see a product you need?

Be sure to check with your local TRP® Parts dealer for additional pricing & availability.

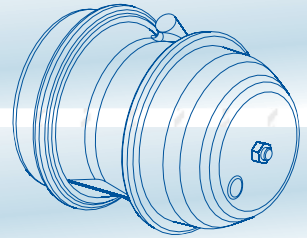
The TRP® Bus Catalog contains information from a variety of suppliers and brands, including many listed below. All brand-names, logos, images, information that came from our suppliers and vendors are trademarked, registered and property of that supplier.

3M	Gunk®	Performance Friction
Accuride	Espar	Prestolite Electric
Baldwin Filters	Hadley	Phillips & Temro
Cummins Filtration	Haldex	Racor
Barksdale	Hendrickson	Reflexite
Bendix	Horton	Ridewell
BorgWarner	HOTSTART	Rosco
Cat's Eye®	Interstate-McBee	SAF-Holland
Chevron	Kidde	Seats, Inc.
Cummins	Knoedler Manufacturers	Shell Oil
Delphi	Leece-Neville	Spicer®
Dana	Link	TRP®
Donaldson	Mascot	TRW
Engine Control Systems	Meritor	Webasto
ExxonMobil	Mitsubishi	Webb
First Aid Only	Neway	Weller
Goodyear	Pana-Pacific	
Gunitite	Panasonic	

*To provide feedback on this TRP® Bus Catalog,
please contact us at TRPBus@TRPParts.com.*



Parts for all brands of buses.



1

BUS PARTS

BRAKES

*Proven, reliable and
always innovative.*

TRP® offers reliable aftermarket products that are designed and tested to exceed customers' expectations regardless of the bus make, model or age.



CALIPERS • DRUMS • PADS •
ROTORS • SHOES • SLACK ADJUSTERS



BUS PARTS

Tested. Reliable. Guaranteed.

Brakes

Choosing the right replacement part or service for your vehicle—whether you own one, or a fleet—is one of the most important decisions you can make for your business. And, with tested TRP® parts it's an easy decision.

Regardless of the make you drive, TRP® quality replacement parts are engineered to fit your truck, trailer or bus. Choose the parts that give you the best value for your business. Check them out at an approved TRP® retailer near you.

The cross reference information in this catalog is based upon data provided by several industry sources and our partners. While every attempt is made to ensure the information presented is accurate, we bear no liability due to incorrect or incomplete information.

Product Availability

Due to export restrictions and market demands, not all products are always available in every location. Check for availability in your area with your local TRP® Distributor.

No part of this marketing material may be reproduced in any manner without written permission from TRP® North America.

CONTENTS

Meritor Friction Materials 1-7

BRAKE PADS

Meritor Hydraulic Brake Pads 1-9

 Universal Pads 1-9

Bendix Hydraulic Brake Pads 1-11

 Inner & Outer Pads 1-11

 Universal Premium Pads 1-12

 Universal Heavy Duty Pads 1-13

Meritor Inner & Outer Pads 1-16

 Inner & Outer Pads 1-16

 Outer Pads 1-17

Bus Applications for Performance Friction Brake Pads 1-18

 International/IC Bus 1-18

 Thomas Built School Bus 1-22

Bus Applications for Bendix Brake Pads 1-24

 Blue Bird 1-24

 Chevrolet 1-24

 Ford 1-24

 International/IC Bus 1-24

BRAKE SHOES

Meritor Brake Shoe Kits 1-26

 15" x 4" Eaton ES Front Brake Shoes 1-26

 15" x 4" Meritor Q Plus Front Brake Shoes 1-26

 16-1/2" x 5" Eaton ES Brake Shoes 1-26

 16-1/2" x 5" Meritor Q Brake Shoes 1-27

 16-1/2" x 6" Eaton ES Brake Shoes 1-27

 16-1/2" x 6" Meritor Q Brake Shoes 1-27

 16-1/2" x 6" Meritor Q Brake Shoes with Relocated Return Spring Hole 1-28

 16-1/2" x 7" Eaton Brake Shoes 1-28

 16-1/2" x 7" Eaton ES I Brake Shoes 1-29

TRP® North America

750 Houser Way N.
Renton, WA 98057

www.trpparts.com

16-1/2" x 7" Eaton ES II Brake Shoes 1-29

16-1/2" x 7" Meritor Q Brake Shoes 1-29

16-1/2" x 7" Meritor Q Brake Shoes - High End 1-30

16-1/2" x 7" Meritor Q Plus Brake Shoes . . . 1-31

16-1/2" x 7" Meritor Q Plus Brake Shoes High End 1-31

16-1/2" x 8-5/8" Eaton ES Brake Shoes . . . 1-32

16-1/2" x 8-5/8" Meritor Q Brake Shoes . . . 1-32

HYDRAULIC BRAKE LINES & FITTINGS

HPB Master Cylinder Assembly 1-33

Steel Brake Lines and Fittings - for Domestic vehicles 1-34

Steel Brake Adapter Lines 1-35

Steel Brake Line Fittings - for Domestic vehicles 1-35

Steel Brake Lines and Fittings - for Import vehicles 1-36

Steel Brake Line Fittings - for Import vehicles 1-36

BRAKE HARDWARE

15" Hardware Kits 1-37

 Eaton OE - 15" Eaton OE Hardware Kit 1-37

 Eaton AfterMarket - 15" Eaton AfterMarket Hardware Kit 1-37

 Eaton for FMSI 4729 - 15" Eaton Hardware Kit for FMSI 4729 1-37

 Eaton Steer Axle ES (Reduced Envelope) - 15" Eaton ES (Reduced Envelope) Steer Axle Hardware Kit 1-38

 Eaton Drive Axle ES (Reduced Envelope) - 15" Eaton ES (Reduced Envelope) Drive Axle Hardware Kit 1-38

 Meritor Q Overhaul - 15" Meritor Q OE Overhaul Hardware Kit 1-39

 Meritor Q Complete Overhaul - 15" Meritor Q Complete Overhaul Hardware Kit 1-39

 Meritor Q Offset Spider - 15" Meritor Q Offset Spider Hardware Kit 1-40

 Meritor Q Plus with TrackLok - 15" Meritor Q Plus TrackLok Hardware Kit 1-40

 Meritor Q Plus - Front Steer Axle with Heavy Duty Spring - 15" Meritor Q Plus Front Steer Axle with

 Heavy Duty Spring Hardware Kit 1-40

16-1/2" Hardware Kits 1-41

 Eaton ES - 16-1/2" Eaton ES AfterMarket Hardware Kit 1-41

 Eaton with Fabricated Brake Shoes - 16-1/2" Eaton Standard Brake with Fabricated Shoes Hardware Kit 1-41

 Eaton with Heavy Duty Return Spring - 16-1/2" Eaton AfterMarket Heavy Duty Return Spring Hardware Kit 1-41

 Eaton - Drive Axle with High Mount Brake Shoes - 16-1/2" Eaton Drive Axle with High Mount Brake Shoes Hardware Kit 1-42

 Eaton ES Drive Axle - 16-1/2" Eaton ES Drive Axle OE Hardware Kit 1-42

 Eaton ES - Drive Axle with Cast Brake Shoes - Complete Overhaul - 16-1/2" Eaton ES Brake with Cast Shoes Complete Overhaul Hardware Kit 1-43

 Eaton ES - Drive Axle with Fabricated Brake Shoes - Complete Overhaul - 16-1/2" Eaton ES Brake with Fabricated Shoes Complete Overhaul Hardware Kit 1-43

 Eaton ES II Front Axle - 16-1/2" Eaton ES II Drive Axle OE Hardware Kit 1-44

 Eaton ES II Front Axle - OE Kit - 16-1/2" Eaton ES II Front Axle OE Hardware Kit 1-44

 Eaton ES II - AfterMarket Kit - 16-1/2" Eaton ES II AfterMarket Hardware Kit 1-44

 Meritor Q Complete Overhaul - 16-1/2" Meritor Q Complete Overhaul Hardware Kit 1-45

 Meritor Q with Heavy Duty Return Spring (kit without bushings) - 16-1/2" Meritor Q with Heavy Duty Return Spring Hardware Kit (without bushings) 1-45

 Meritor Q - Front Steer Axle (services clipped and hammerclaw cams) - 16-1/2" Meritor Q Front Steer Axle Hardware Kit 1-46

 Meritor Q - Front Steer Axle Complete Overhaul (services clipped and hammerclaw cams) - 16-1/2" Meritor Q Front Steer Axle Complete Overhaul Hardware Kit (services clipped and hammerclaw cams) 1-46

 Intraxx, Meritor Q, Q Plus and Spicer XLII AfterMarket with Heavy Duty Return Spring - 16-1/2" Intraxx and Meritor Q, Q Plus and Spicer XLII with Heavy Duty Return Spring AfterMarket Hardware Kit . . . 1-47

BRAKE DRUMS

15" Drums 1-48

16.50" x 5.00" Drums 1-48

16.50" x 6.00" Drums 1-48

16.50" x 7.00" Drums 1-49

16.50" x 8" or more Drums 1-49

BRAKE SLACK ADJUSTERS

Meritor Slack Adjusters 1-50
 Meritor Automatic Slack Adjusters (stroke sensing) 1-50
Meritor Automatic Slack Adjuster Repair Kits 1-54
 Drive Axle Applications - 16-1/2" and 18" Brakes 1-54
 Steer Axle (non-drive) applications - 15", 16-1/4" and 16-1/2" Brakes 1-55
 Transit Applications 1-57

CROSS REFERENCE

Brake Slack Adjusters Cross Reference . . 1-65
 Rockwell 1-65

BRAKE S-CAMS

10 spline / 1-1/4" Diameter 1-69
Meritor S-Cam Repair Kits 1-70
 Eaton 15" brakes Meritor S-Camshaft repair kit 1-71
 Eaton 15" and 16-1/2" Brakes Meritor S-Camshaft repair kit 1-71
 Eaton 15", 16-1/2" and 18" Brakes Meritor S-Camshaft repair kit 1-72
 Meritor 15" and 16-1/2" - Q and Q Plus Brakes Meritor S-Camshaft repair kit 1-72
 Meritor 16-1/2" - P, Q, Q Plus brakes Meritor S-Camshaft repair kit 1-73
 Meritor 16-1/2" Q Plus Long Life brakes (LX500) - K1T8883 - Meritor S-Camshaft repair kit 1-73
Eaton 15" "ES" Single Web Brakes (Drawing) 1-74
Eaton 15" "ES" Double Web Brakes (Drawing) 1-75
Eaton 15" Reduced Envelope Brakes (Drawing) 1-76
Eaton 16-1/2" Truck & Tractor Brakes (Drawing) 1-77
Meritor "Q Plus" - 15"-16 1/2" Brakes

(Drawing) 1-83
10 spline / 1-1/2" Diameter 1-84
 Eaton Drive Axles with 16-1/2" and 18" brakes 1-84
Eaton ES - II 1-85
 Eaton Drive Axles with 16-1/2" ES (Extended Service) and 15" Reduced Envelope brakes 1-85
Transit Applications with Meritor Brakes . . 1-86
Transit Applications with Meritor Brakes with Head End Snap Ring Groove 1-87
28 spline / 1-1/2" Diameter 1-88
 Meritor "Q Plus" brakes 1-88
Meritor "Q Plus" Brakes with Tracklock . . . 1-94

CROSS REFERENCE

Brake S-Cams Cross Reference 1-95
 Batco 1-95
 BWP 1-96
 CR 1-96
 Dana 1-96
 Eaton 1-97
 Euclid 1-98
 Leland 1-98
 Midland 1-99
 Navistar 1-99
 Rockwell 1-99
 Sirco 1-101
 Spicer 1-102
 Transit 1-102
Bendix Hydraulic Disc Single Piston Brakes (Drawing) 1-103
Bendix Hydraulic Disc 2.60 Twin Piston Brakes (Drawing) 1-103
Bendix Hydraulic Disc 2.88 Twin Piston Brakes (Drawing) 1-105
Bosch Hydraulic 66mm Pin Slide Disc Brakes (Drawing) 1-106
Meritor Hydraulic Disc 2.50" Twin Piston Brakes (Drawing) 1-108

Meritor Hydraulic Disc 4x64mm Quadraulic Phenolic Piston Brakes (Drawing) 1-109
Meritor Hydraulic Disc 4x70mm Quadraulic Phenolic Piston Brakes (Drawing) 1-110
Hydraulics Brakes & Brake Parts 1-111
 Meritor Hydraulic Disc Brake Parts - 2.50" Twin Piston 1-111
 Meritor Hydraulic Disc Brake Parts - 4 x 64mm Quadraulic Phenolic Piston (7/16" - 24 Inlet) 1-111
 Meritor Hydraulic Disc Brake Parts - 4 x 70mm Quadraulic Phenolic Piston (7/16" - 24 Inlet) 1-112
 Bendix Hydraulic Disc Brake Parts - 3.38" Single Piston 1-113
 Bendix Hydraulic Disc Brake Parts - 2.60" Twin Piston 1-114
 Bendix Hydraulic Disc Brake Parts - 2.88" Twin Piston 1-115
Meritor Hydraulic Disc Brake Parts 1-117
 Meritor Hydraulic Disc Brake Parts - 66mm 1-117
 Meritor Hydraulic Disc Brake Parts - 73mm 1-117

BRAKE CALIPERS

Bendix Hydraulic Calipers 1-119
Meritor Hydraulic Calipers 1-120
 Meritor Caliper - 2.362" (60mm) Twin Piston - Left Hand 1-120
 Meritor Caliper - 2.362" (60mm) Twin Piston - Right Hand 1-120
 Meritor Caliper - 2.60" Bendix Twin Piston - Left & Right Hand applications 1-120
 Meritor Caliper - 2.88" Bendix Twin Piston - Second design (post 1988) - Left & Right Hand applications 1-120
 Meritor Caliper - 2.88" Bendix Twin Piston - Left & Right Hand applications . . . 1-120
 Meritor Caliper - 3.38" (3-3/8") Single Piston - Left Hand 1-121
 Meritor Caliper - 3.38" (3-3/8") Single Piston - Right Hand 1-121
 Meritor Caliper - 45mm Twin Piston - Left

Hand 1-121
 Meritor Caliper - 45mm Twin Piston - Right Hand 1-121
 Meritor Caliper - 48mm Twin Piston - Left Hand 1-121
 Meritor Caliper - 48mm Twin Piston - Right Hand 1-121
 Meritor Caliper - 54mm Twin Piston - Left Hand 1-121
 Meritor Caliper - 54mm Twin Piston - Right Hand 1-121
 Meritor Caliper - 54mm GM (Class 3 Vehicle) - Left Hand 1-121
 Meritor Caliper - 54mm GM (Class 3 Vehicle) - Right Hand 1-122
 Meritor Caliper - 57mm GM - Left Hand . . 1-122
 Meritor Caliper - 57mm GM - Right Hand 1-122
 Meritor Caliper - 60mm Twin Piston - Left Hand 1-122
 Meritor Caliper - 60mm Twin Piston - Right Hand 1-122
 Meritor Caliper - 64mm quadraulic phenolic piston - Left & Right Hand applications . . . 1-122
 Meritor Caliper - 66mm Twin Piston - Left & Right Hand applications 1-122
 Meritor Caliper - 70mm (2.76") four piston - Left Hand inlet port for Meritor Caliper (facing the bridge tube) -7/16" - 24 threads 1-122
 Meritor Caliper - 70mm (2.76") four piston - Right Hand inlet port for Meritor Caliper (facing the bridge tube) -7/16" - 24 threads 1-123
 Meritor Caliper - 70mm (2.76") four piston - Left Hand inlet port for Meritor Caliper (facing the bridge tube) - 10mmx1.5mm between threads 1-123
 Meritor Caliper - 70mm (2.76") four piston - Right Hand inlet port for Meritor Caliper (facing the bridge tube) - 10mmx1.5mm between threads 1-123
 Meritor Caliper - 70mm quadraulic phenolic piston - Left & Right Hand applications . . . 1-123
 Meritor Caliper - 70mm phenolic piston - Left Hand inlet port for Meritor Caliper (facing the bridge tube) -7/16" - 24 threads 1-124
 Meritor Caliper - 70mm phenolic piston - Right Hand inlet port for Meritor Caliper (facing the

bridge tube) -7/16" - 24 threads 1-124
 Meritor Caliper - 73mm Twin Piston - Left & Right
 Hand applications 1-124

BRAKE ROTORS

Webb® Brake Rotors 1-125
 5-Hole Hat 1-125
 5-Hole U 1-125
 6-Hole Hat 1-125
 6-Hole U 1-125
 10-Hole Hat 1-125
 10-Hole U 1-126
 10-Hole Hat for ABS 1-126
Performance Friction Brake Rotors 1-126
 5-Hole Hat 1-126
 10-Hole Hat 1-126
 10-Hole U 1-126
Bendix Brake Rotors 1-127
 5-Hole Hat 1-127
 5-Hole U 1-127
 6-Hole Hat 1-128
 6-Hole U 1-129
 8-Hole U 1-130
 8-Hole Hat 1-130
 10-Hole Hat 1-130
 10-Hole U 1-131
 8-Hole Hub & Rotor Units 1-131
Bus Applications for Brake Rotors 1-132
 AC Delco 1-132
 Bendix 1-132
 Bendix Formula Blue 1-132
 BlueBird 1-132
 BlueBird Front/Rear 19K Max
 (ABS Applications) 1-132
 Dayton 1-132
 Euclid 1-132
 Ford 1-132
 Ford Front Axles - 1983 and newer 1-132
 Ford Front Axles - 1984 and newer 1-132

Ford Front Axles (ABS Applications) 1-132
 Freightliner/Thomas Built 1-132
 GM Front/Rear (ABS Applications) 1-132
 GMC 1-132
 GMC/Chevrolet Front and Rear Axles 1-132
 GMC/Chevrolet Front Axles 1-132
 Gunitite 1-132
 International/IC Bus/Navistar 1-132
 ABS Applications 1-132
 Front & Rear Axles 1-132
 Navistar - PFC 1-132
 Meritor 1-132
 Webb 1-132
Bus Applications for Bendix
 Brake Rotors 1-133
 Blue Bird 1-133
 Chevrolet 1-133
 Ford 1-133
 International/IC Bus 1-134
TRP® Brake Chambers 1-136
Haldex Brake Chambers 1-136

CROSS REFERENCE

Cross Reference for Brakes 1-137



MERITOR FRICTION MATERIALS



MERITOR FRICTION MATERIALS

MA212 STANDARD BUS/TRUCK/TRACTOR/TRAILER

General Information	Rating
MA212 is the standard Meritor 21,000 lb. gross axle weight rated (GAWR) brake lining for OEM production brakes. This proven material yields exceptional brake power and friction stability without sacrificing lining or drum wear. MA212 is the standard friction on Meritor trailer axles and is the lining of choice of many OEM vehicle manufacturers. It can be used for over-the-highway applications or in stop-and-go urban driving. MA212 is recommended for truck, tractor, trailer and school bus applications.	MA212 is rated for 21,000 lb. GAWR at 165 AL (T30 chamber x 5.5" slack adjuster).

MA301 STANDARD BUS/TRUCK/TRACTOR/TRAILER

General Information	Rating
R301 is the standard Meritor 23,000 lb. GAWR brake lining for OEM production brakes. This time-proven high-performance Meritor material is engineered for demanding applications where excellent wear characteristics are needed. R301 is recommended for truck, tractor, trailer and school bus applications.	R301 is rated for 23,000 lb. GAWR at 180 AL (T30 chamber x 6.0" slack adjuster)

MA310 PREMIUM BUS/TRUCK/TRACTOR/TRAILER

General Information	Rating
MA310 has been developed as the standard Meritor 23,000 lb. GAWR brake lining for vocational vehicle applications. This material provides remarkable wear and exceptional stopping ability for the vocational needs of a fleet. MA310 was designed for demanding applications that require consistent fade resistance and solid recovery performance. MA310 is recommended for construction and other heavy hauling applications. It can be used on- or off-highway in various terrain conditions.	MA310 is rated for 23,000 lb. GAWR at 165 AL (T30 chamber x 5.5" slack adjuster).

Information & Images Provided by Meritor

MA312 STANDARD BUS/TRUCK/TRACTOR/TRAILER

General Information	Rating
<p>MA312 provides superior stopping power needed in demanding heavy duty linehaul and vocational vehicle operations. MA312 friction material not only meets, but surpasses, FMVSS 121 requirements in combination with either full-cast or lightweight Meritor Steellite X30™ brake drums.</p> <p>MA312 is a premium, long-life material delivering exceptional performance in applications up to 23,000 GAWR.</p> <p>It offers service-life improvements of up to 20 percent over comparable products, reducing costs of maintenance, downtime and materials.</p> <p>MA312 is ideally suited to truck, tractor, trailer and school bus applications. It is recommended for heavy hauling applications where sure stopping power is called for. It is designed to perform equally well in both on- and off-highway applications.</p>	<p>MA312 is rated for 23,000 lb. GAWR at 180 AL (T30 chamber x 6.0" slack adjuster).</p>

MA403 SEVERE-DUTY BUS/TRUCK/TRACTOR/TRAILER

General Information	Rating
<p>R403 is the Meritor 26,000 lb. GAWR brake lining for severe-duty applications. It has superior performance and fade-resistance and dependable stopping capability in heavy-haul applications.</p> <p>R403 is recommended for construction, refuse and other severe service applications, on- or off-highway, under various terrain conditions. It has a proven track record of recognized durability.</p>	<p>R403 is rated for 26,000 lb. GAWR at 180 AL (T30 chamber x 6.0" slack adjuster).</p>

Information & Images Provided by Meritor




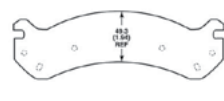
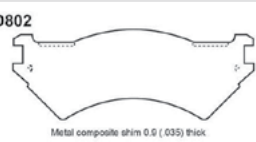

BRAKE PADS



Meritor Hydraulic Disc Brake Pads: sold in sets of 4; 1 set = 2 outer pads and 2 inner pads.








MERITOR HYDRAULIC BRAKE PADS

Table 1-1: Meritor Universal Pads

Product	Part Number	Description	FMSI Set No.	FMSI Pad No.	Backing Plate Length	Backing Plate Thickness	Comments
	MD224	Meritor Universal Pads	7141, 7807	D224	8-13/32"	1/4"	4 per set Lining length = 8-11/32"
	MMD224	Meritor Universal Pads	7141, 7807	D224	8-13/32"	1/4"	4 per set Lining length = 8-11/32"
	MD655	Meritor Universal Pads	7535	D655	8-43/64"	1/4"	
	MMD655	Meritor Universal Pads	7535	D655	8-43/64"	1/4"	
	MD777	Meritor Universal Pads	7627	D777	8-3/4"	1/4"	
	MMD777	Meritor Universal Pads	7627	D777	8-3/4"	1/4"	
	MD784	Meritor Universal Pads	7652	D784	8-1/2"	1/4"	Metal composite shim 1/32" (.035) thick Two shoes have two sensors staked-on Two shoes have one sensor (LH, RH) staked on
	MMD784	Meritor Universal Pads	7652	D784	8-1/2"	1/4"	Metal composite shim 1/32" (.035) thick Two shoes have two sensors staked-on Two shoes have one sensor (LH, RH) staked on
 <p>Metal composite shim 0.0 (.035) thick</p>	MD802	Meritor Universal Pads	7673	D802	7-27/64"	1/4"	Metal composite shim 1/32" (.035) thick
	MMD802	Meritor Universal Pads	7673	D802	7-27/64"	1/4"	Metal composite shim 1/32" (.035) thick
	MD989	Meritor Universal Pads	7891	D989	8-19/32"	9/32"	4 pieces with wear sensors (LH, RH) Composite shim 1/32" (.038) thick staked-on
	MMD989	Meritor Universal Pads	7891	D989	8-19/32"	9/32"	4 pieces with wear sensors (LH, RH) Composite shim 1/32" (.038) thick staked-on

MD = Standard Pad
MVD = Value Pad
MMD = Frequent Stop Pad

Information & Images Provided by Meritor

Product	Part Number	Description	FMSI Set No.	FMSI Pad No.	Backing Plate Length	Backing Plate Thickness	Comments
	MD1064	Meritor Universal Pads	7969	D1064	11-11/32"	15/64"	
	MMD1064	Meritor Universal Pads	7969	D1064	11-11/32"	15/64"	
	MD1066	Meritor Universal Pads	7972	D1066	8-3/4"	15/64"	
	MMD1066	Meritor Universal Pads	7972	D1066	8-3/4"	15/64"	
	MD1067	Meritor Universal Pads	7973	D1067	6-63/64"	1/4"	
	MMD1067	Meritor Universal Pads	7973	D1067	6-63/64"	1/4"	
	MD1068	Meritor Universal Pads	7973	D1068	6-63/64"	1/4"	
	MMD1068	Meritor Universal Pads	7973	D1068	6-63/64"	1/4"	
	MD1069	Meritor Universal Pads	7974	D1069	n/a	n/a	
	MMD1069	Meritor Universal Pads	7974	D1069	n/a	n/a	
	MD1328	Meritor Universal Pads	8440	D1328	7-5/32"	47/64"	
	MMD1328	Meritor Universal Pads	8440	D1328	7-5/32"	47/64"	
	MD1330	Meritor Universal Pads	8442	D1330	7-31/32"	3/4"	
	MMD1330	Meritor Universal Pads	8442	D1330	7-31/32"	3/4"	

MD = Standard Pad
MVD = Value Pad
MMD = Frequent Stop Pad




Information & Images Provided by Meritor



BENDIX HYDRAULIC BRAKE PADS

All Bendix pads sold in sets of 4 - 2 Inner and 2 Outer pads.

Table 1-2: Bendix Inner and Outer Pads

Product	Part Number	Description	FMSI Set No.	FMSI Inner Pad No.	FMSI Outer Pad No.	Inner Backing Plate Length (mm)	Inner Backing Plate Thickness (mm)	Outer Backing Plate Length (mm)	Outer Backing Plate Thickness (mm)
	E10901840BXW	Bendix Inner and Outer Pads	7108, 7806	D184-I	D184-O	250.3	22.0	266.5	16.5
	E11101840BXW	Bendix Inner and Outer Pads	7108, 7806	D184-I	D184-O	250.3	22.0	266.5	16.5
	E10902250BXW	Bendix Inner and Outer Pads	7142, 7808, 7813, 7818, 7819	D225-I	D225-O	205.3	27.1	270.0	22.3
	E11102250BXW	Bendix Inner and Outer Pads	7142, 7808, 7813, 7818, 7819	D225-I	D225-O	205.3	27.1	270.0	22.3
	E11104110BXW	Bendix Inner and Outer Pads	7149, 7809	D411-I	D411-O	220.0	21.0	235.4	21.0
	E11107170BXW	Bendix Inner and Outer Pads	7815	D717-I	D717-O	250.3	22.0	266.5	16.5

Information & Images Provided by Bendix

Product	Part Number	Description	FMSI Set No.	FMSI Inner Pad No.	FMSI Outer Pad No.	Inner Backing Plate Length (mm)	Inner Backing Plate Thickness (mm)	Outer Backing Plate Length (mm)	Outer Backing Plate Thickness (mm)
	E11113290BXW	Bendix Inner and Outer Pads	7299	D1329-I	D1329-O	202.2	17.0	202.2	15.3

All Bendix pads sold in sets of 4 - 2 Inner and 2 Outer pads.

Table 1-3: Bendix Universal Pads - Premium Pads

Product	Part Number	Description	FMSI Set No.	FMSI Pad No.	Backing Plate Length (mm)	Backing Plate Thickness (mm)
UNIVERSAL PREMIUM PADS						
	E10902240BXW	Semi-Metallic Brake Pads (Premium)	7141, 7807	D224	213.5	19
	E10902360BXW	Semi-Metallic Brake Pads (Premium)	7149, 7809	D236	228.6	25
	E10906550BXW	Semi-Metallic Brake Pads (Premium)	7535	D655	220.2	18.7
	E10907860BXW	Semi-Metallic Brake Pads (Premium)	7654	D786	244	20.3

Information & Images Provided by Bendix

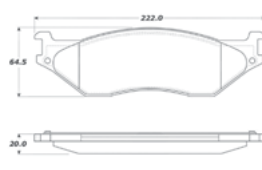
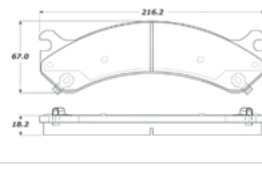
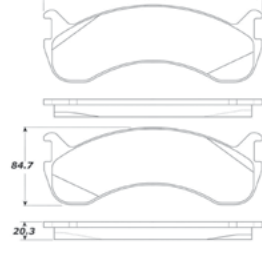
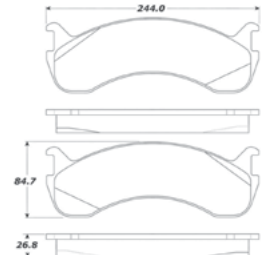
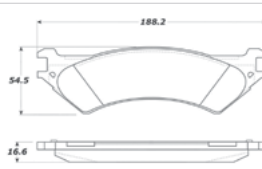
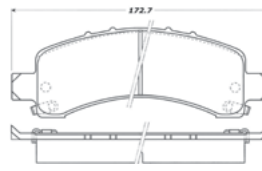

Product	Part Number	Description	FMSI Set No.	FMSI Pad No.	Backing Plate Length (mm)	Backing Plate Thickness (mm)
	E10907861BXW	Semi-Metallic Brake Pads (Premium)	7655	D786	244	26.8
	E10908020BXW	Semi-Metallic Brake Pads (Premium)	7673	D802	188.2	16.6

All Bendix pads sold in sets of 4 - 2 Inner and 2 Outer pads.

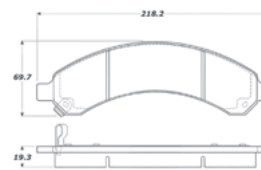
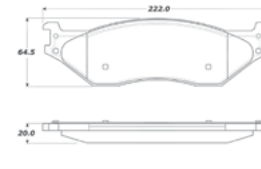
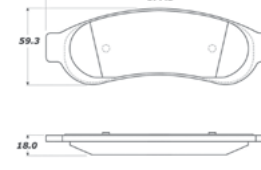
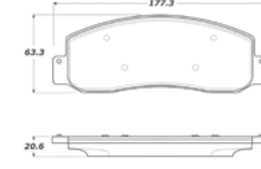
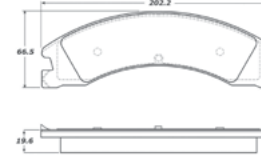
Table 1-4: Bendix Universal Pads - Heavy Duty

Product	Part Number	Description	FMSI Set No.	FMSI Pad No.	Backing Plate Length (mm)	Backing Plate Thickness (mm)
UNIVERSAL HEAVY DUTY PADS						
	E11102240BXW	Extended Wear (Heavy Duty) Brake Pads	7141, 7807	D224	213.5	19
	E11102360BXW	Extended Wear (Heavy Duty) Brake Pads	7149, 7809	D236	228.6	25
	E11106550BXW	Extended Wear (Heavy Duty) Brake Pads	7535	D655	220.2	18.7
	E11107690BXW	Extended Wear (Heavy Duty) Brake Pads	7636	D769	240	25.2

Information & Images Provided by Bendix

Product	Part Number	Description	FMSI Set No.	FMSI Pad No.	Backing Plate Length (mm)	Backing Plate Thickness (mm)
	E11107770BXW	Extended Wear (Heavy Duty) Brake Pads	7644	D777	222	20
	E11107840BXW	Extended Wear (Heavy Duty) Brake Pads	7652	D784	216.2	18.2
	E11107861BXW	Extended Wear (Heavy Duty) Brake Pads	7654	D786	244	20.3
	E11107860BXW	Extended Wear (Heavy Duty) Brake Pads	7655	D786	244	26.8
	E11108020BXW	Extended Wear (Heavy Duty) Brake Pads	7673	D802	188.2	16.6
	E11109740BXW	Extended Wear (Heavy Duty) Brake Pads	7875	D974	172.7	20.1
	E11109741BXW	Extended Wear (Heavy Duty) Brake Pads	7875	D974	172.7	17

Information & Images Provided by Bendix

Product	Part Number	Description	FMSI Set No.	FMSI Pad No.	Backing Plate Length (mm)	Backing Plate Thickness (mm)
	E11109890BXW	Extended Wear (Heavy Duty) Brake Pads	7891	D989	218.2	19.3
	E11110640BXW	Extended Wear (Heavy Duty) Brake Pads	7969	D1064	288	20.1
	E11110660BXW	Extended Wear (Heavy Duty) Brake Pads	7972	D1066	222	20
	E11110670BXW	Extended Wear (Heavy Duty) Brake Pads	7973	D1067	177.3	18
	E11110680BXW	Extended Wear (Heavy Duty) Brake Pads	7973	D1068	177.3	18
	E11110690BXW	Extended Wear (Heavy Duty) Brake Pads	7974	D1069	177.3	20.6
	E11113280BXW	Extended Wear (Heavy Duty) Brake Pads	8440	D1328	214.4	18.7
	E11113300BXW	Extended Wear (Heavy Duty) Brake Pads	8442	D1330	202.2	19.6











Information & Images Provided by Bendix







Meritor Hydraulic Disc Brake Pads: sold in sets of 4; 1 set = 2 outer pads and 2 inner pads.

MERITOR INNER & OUTER PADS

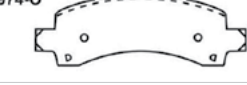

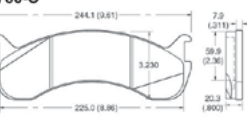

Table 1-5: Meritor Inner and Outer Pads

Product	Part Number	Description	FMSI Set No.	FMSI Inner Pad No.	FMSI Outer Pad No.	Inner Backing Plate Length	Inner Backing Plate Thickness	Outer Backing Plate Length	Outer Backing Plate Thickness	Comments
	MD184	Meritor Inner and Outer Pads	7806	D184-I	D184-O	8-5/64"	17/64"	10-1/16"	13/64"	
										
	MD380	Meritor Inner and Outer Pads	7806	D184-I	D184-O	8-5/64"	17/64"	10-1/16"	13/64"	
										
	MD225	Meritor Inner and Outer Pads	7808, 7818	D225-I	D225-O	8-5/64"	17/64"	10-5/8"	7/32"	
										
	MD380	Meritor Inner and Outer Pads	7815	D380-I	D380-O	8-5/64"	17/64"	10 1/16"	13/64"	
										
	MD411	Meritor Inner and Outer Pads	7299	D411-I	D411-O	8-21/32"	7/32"	9-17/64"	7/32"	
										

MD= Standard Pad
MVD = Value Pad
MMD = Frequent Stop Pad
Information & Images Provided by Meritor

Product	Part Number	Description	FMSI Set No.	FMSI Inner Pad No.	FMSI Outer Pad No.	Inner Backing Plate Length	Inner Backing Plate Thickness	Outer Backing Plate Length	Outer Backing Plate Thickness	Comments
	MD974	Meritor Inner and Outer Pads	7875, 7881	D974-I	D974-O	6-51/64"	1/4"	6-51/64"	1/4"	
										
	MD1329	Meritor Inner and Outer Pads	8441	D1329-I	D1329-O	7-31/32"	11/16"	7-31/32"	5/8"	
										

OUTER PADS

	MD786	Meritor Outer Pads	7655		D786-O			9-39/64"	5/16"	D786-O - 73 mm
										
	MD786A	Meritor Outer Pads	7654		D786-O			9-39/64"	5/16"	D786-O - 66mm for Bosch pin side caliper
										

MD= Standard Pad
MVD = Value Pad
MMD = Frequent Stop Pad
Information & Images Provided by Meritor

BUS APPLICATIONS FOR PERFORMANCE FRICTION BRAKE PADS

Table 1-6: Bus Applications for Performance Friction Brake Pads

Application	Year	Position	Description	PF Part Number
BLUE BIRD				
TC1000	99-02	Front Brake Pad	With Bosch 66mm pinslider caliper	0786.10 or 0786.20
	99-02	Rear Brake Pad	With Bosch 73mm pinslider caliper	0786.11 or 0786.21
	99-02	Front Brake Pad	With Bosch 66mm pinslider caliper	0786.10 or 0786.20
	99-02	Rear Brake Pad	With Bosch 73mm pinslider caliper	0786.11 or 0786.21
	97-98	Front Brake Pad	With Bendix 3.36 in. Caliper, With o wear sensors	0184.10 or 0184.20
	97-98	Rear Brake Pad	With Bendix 3.36 in. Caliper, With o wear sensors	0184.10 or 0184.20
	97-98	Front Brake Pad	With Bendix 2.88 in. Caliper	0225.10 or 0225.20
	97-98	Rear Brake Pad	With Bendix 2.88 in. Caliper	0225.10 or 0225.20
TC2000	99-04	Front Brake Pad	With Bosch 66mm pinslider caliper	0786.10 or 0786.20
	99-04	Rear Brake Pad	With Bosch 66mm pinslider caliper	0786.10 or 0786.20
	99-04	Front Brake Pad	With Bosch 73mm pinslider caliper	0786.11 or 0786.21
	99-04	Rear Brake Pad	With Bosch 73mm pinslider caliper	0786.11 or 0786.21
	89-97	Front Brake Pad	With Bendix 2.88 in. Caliper	0225.10 or 0225.20
	89-97	Rear Brake Pad	With Bendix 2.88 in. Caliper	0225.10 or 0225.20
American	99-02	Front Brake Pad	With Bosch 66mm pinslider caliper	0786.10 or 0786.20
	99-02	Rear Brake Pad	With Bosch 66mm pinslider caliper	0786.10 or 0786.20
	99-02	Front Brake Pad	With Bosch 73mm pinslider caliper	0786.11 or 0786.21
	99-02	Rear Brake Pad	With Bosch 73mm pinslider caliper	0786.11 or 0786.21
	79-97	Front Brake Pad	With Bendix 3.36 in. Caliper, With o wear sensors	0184.10 or 0184.20
	79-97	Rear Brake Pad	With Bendix 3.36 in. Caliper, With o wear sensors	0184.10 or 0184.20
	79-97	Front Brake Pad	With Bendix 2.88 in. Caliper	0225.10 or 0225.20
	79-97	Rear Brake Pad	With Bendix 2.88 in. Caliper	0225.10 or 0225.20
CV200	99-02	Front Brake Pad	With Bosch 66mm pinslider caliper	0786.10 or 0786.20
	99-02	Rear Brake Pad	With Bosch 66mm pinslider caliper	0786.10 or 0786.20
	99-02	Front Brake Pad	With Bosch 73mm pinslider caliper	0786.11 or 0786.21
	99-02	Rear Brake Pad	With Bosch 73mm pinslider caliper	0786.11 or 0786.21
Commercial Bus	99-02	Front Brake Pad	With Bosch 73mm pinslider caliper	0786.11 or 0786.21
	99-02	Rear Brake Pad	With Bosch 73mm pinslider caliper	0786.11 or 0786.21
	to 98	Front Brake Pad	With Bendix 3.36 in. Caliper, With o wear sensors	0184.10 or 0184.20
	to 98	Rear Brake Pad	With Bendix 3.36 in. Caliper, With o wear sensors	0184.10 or 0184.20
	to 98	Front Brake Pad	With Bendix 2.88 in. Caliper	0225.10 or 0225.20
	to 98	Rear Brake Pad	With Bendix 2.88 in. Caliper	0225.10 or 0225.20

*To determine proper part: 0786.10=66mm caliper/0786.11=73mm caliper 0786.10 or 20 is 0.80" thick, 0786.11 or 0786.21 is 1.055" thick

Application	Year	Position	Description	PF Part Number
Micro Bird Type A	95-06	Front Brake Pad	Ford E250/E350 Econoline Chassis	0655.20
	95-06	Rear Brake Pad	Ford E250/E350 Econoline Chassis	0802.20
	92-94	Front Brake Pad	Ford Chassis	0557.20
	81-91	Front Brake Pad	Ford Chassis	0450.20
	03-06	Front Brake Pad	GM 2500 Express and Savana With 7300lb gww	0784.20
	03-06	Rear Brake Pad	GM 2500 Express and Savana With 7300lb gww	0974.20
	03-06	Front Brake Pad	GM 2500 Express and Savana With 8500-8600lb gww	0785.20
	03-06	Rear Brake Pad	GM 2500 Express and Savana With 8500-8600lb gww	0974.20
	99-02	Front Brake Pad	GM 2500 Express and Savana Diesel	0459.20
	99-02	Front Brake Pad	GM 2500 Express / Savana gas With 7100-7300 6 stud whl	0369.20
	99-02	Front Brake Pad	GM 2500 Express / Savana gas With 7700-8600 8 stud whl	0370.20
	03-06	Front Brake Pad	GM 3500 Express and Savana With DRW	0784.20
	03-06	Rear Brake Pad	GM 3500 Express and Savana With DRW	0989.20
	03-06	Front Brake Pad	GM 3500 Express and Savana With SRW	0784.20
	03-06	Rear Brake Pad	GM 3500 Express and Savana With SRW	0974.20
	02	Front Brake Pad	GM 3500 Express and Savana	0459.20
	99-01	Front Brake Pad	GM 3500 Express and Savana With DRW	0459.20
	99-01	Front Brake Pad	GM 3500 Express and Savana With SRW	0370.20
Type C Vision	01-07	Front Brake Pad	With wear sensor	0769.10
	01-07	Rear Brake Pad	With wear sensor	0769.10
	01-07	Front Brake Pad	With o wear sensor	1032.10
	01-07	Rear Brake Pad	With o wear sensor	1032.10
Type D All American	03-07	Front Brake Pad	With wear sensor	0769.10
	03-07	Rear Brake Pad	With wear sensor	0769.10
	03-07	Front Brake Pad	With o wear sensor	1032.10
	03-07	Rear Brake Pad	With o wear sensor	1032.10
	01-02	Front Brake Pad	from 11/05/01 With wear sensor	0769.10
	01-02	Rear Brake Pad	from 11/05/01 With wear sensor	0769.10
	01-02	Front Brake Pad	from 11/05/01 With o wear sensor	1032.10
	01-02	Rear Brake Pad	from 11/05/01 With o wear sensor	1032.10
	98-02	Front Brake Pad	to 11/04/01 With Bosch 73mm caliper	0786.11 or 0786.21
	98-02	Rear Brake Pad	to 11/04/01 With Bosch 73mm caliper	0786.11 or 0786.21
	89-00	Front Brake Pad	With Bendix 2.88" Caliper inc Tranist	0225.10 or 0225.20
	89-00	Rear Brake Pad	With Bendix 2.88" Caliper inc Tranist	0225.10 or 0225.20
		Front Rotor Assy.	Retrofit Rotor Assembly	390.086.20*, Blue Bird PN 0044646*

Application	Year	Position	Description	PF Part Number
INTERNATIONAL/IC Bus				
Scout	74-80	Front Brake Pad		0050.20
150	75-76	Front Brake Pad		0050.20
D200 PickUp	74-75	Front Brake Pad	With Std brakes	0050.20
	74-75	Front Brake Pad	With HD brakes	0149.20
1400 Metro II	87-89	Front Brake Pad	With Bendix 3.36 With o wear sensors	0184.10 or 0184.20
	87-89	Rear Brake Pad	With Bendix 3.36 With o wear sensors	0184.10 or 0184.20
S1452/1452SC	84-98	Front Brake Pad	With Bendix 2.88 caliper	0225.10 or 0225.20
	84-98	Rear Brake Pad	With Bendix 2.88 caliper	0225.10 or 0225.20
M1600/1652 Metro	88-95	Front Brake Pad	With Bendix 2.88 caliper	0225.10 or 0225.20
	88-95	Rear Brake Pad	With Bendix 2.88 caliper	0225.10 or 0225.20
1650 SC	98-00	Front Brake Pad	With hydraulic brakes	0786.10* or 0786.11*
	98-00	Rear Brake Pad	With hydraulic brakes	0786.10* or 0786.11*
1650 Cargostar	83-97	Front Brake Pad	With Bendix 3.36 With o wear sensors	0184.10 or 0184.20
	83-97	Rear Brake Pad	With Bendix 3.36 With o wear sensors	0184.10 or 0184.20
	83-97	Front Brake Pad	With Bendix 2.88 caliper	0225.10 or 0225.20
	83-97	Rear Brake Pad	With Bendix 2.88 caliper	0225.10 or 0225.20
S1624, S1652FC, S1652SC	98-04	Front Brake Pad	With 2.60" Caliper	0786.10 or 0786.20
	98-04	Rear Brake Pad	With 2.60" Caliper	0786.10 or 0786.20
	98-04	Front Brake Pad	With 2.88" caliper	0786.11 or 0786.21
	98-04	Rear Brake Pad	With 2.88" caliper	0786.11 or 0786.21
	83-97	Front Brake Pad	With 2.88" caliper	0225.10 or 0225.20
	83-97	Rear Brake Pad	With 2.88" caliper	0225.10 or 0225.20
1700 Series Bus	79-89	Front Brake Pad	With Bendix 3.36 With o wear sensors	0184.10 or 0184.20
	79-89	Rear Brake Pad	With Bendix 3.36 With o wear sensors	0184.10 or 0184.20
	79-89	Front Brake Pad	With Bendix 2.88 caliper	0225.10 or 0225.20
	79-89	Rear Brake Pad	With Bendix 2.88 caliper	0225.10 or 0225.20
CO1710A B CargoStar	83-85	Front Brake Pad	With Bendix 2.88 caliper	0225.10 or 0225.20
	83-85	Rear Brake Pad	With Bendix 2.88 caliper	0225.10 or 0225.20
S1723,1753,1724,1754	83-98	Front Brake Pad	With Bendix 2.88 caliper	0225.10 or 0225.20
	83-98	Rear Brake Pad	With Bendix 2.88 caliper	0225.10 or 0225.20
1750 Cargostar	83-89	Front Brake Pad	With Bendix 3.38/2.60 caliper	0184.10 or 0184.20
	83-89	Rear Brake Pad	With Bendix 3.38/2.60 caliper	0184.10 or 0184.20
	83-89	Front Brake Pad	With Bendix 2.88 caliper	0225.10 or 0225.20
	83-89	Rear Brake Pad	With Bendix 2.88 caliper	0225.10 or 0225.20
1753 Series Bus	84-97	Front Brake Pad	With Bendix 3.38/2.60 caliper	0184.10 or 0184.20
	84-97	Rear Brake Pad	With Bendix 3.38/2.60 caliper	0184.10 or 0184.20
	84-97	Front Brake Pad	With Bendix 2.88 caliper	0225.10 or 0225.20
	84-97	Rear Brake Pad	With Bendix 2.88 caliper	0225.10 or 0225.20
1800 Series	81-83	Front Brake Pad	With Bendix 3.36 With o wear sensors	0184.10 or 0184.20
	81-83	Rear Brake Pad	With Bendix 3.36 With o wear sensors	0184.10 or 0184.20

Application	Year	Position	Description	PF Part Number
1850 Series	84-97	Front Brake Pad	With Bendix 3.36 With o wear sensors	0184.10 or 0184.20
	84-97	Rear Brake Pad	With Bendix 3.36 With o wear sensors	0184.10 or 0184.20
	84-97	Front Brake Pad	With Bendix 2.88 caliper	0225.10 or 0225.20
	84-97	Rear Brake Pad	With Bendix 2.88 caliper	0225.10 or 0225.20
1853 Series Bus	83-97	Front Brake Pad	With Bendix 3.36 With o wear sensors	0184.10 or 0184.20
	83-97	Rear Brake Pad	With Bendix 3.36 With o wear sensors	0184.10 or 0184.20
	83-97	Front Brake Pad	With Bendix 2.88 caliper	0225.10 or 0225.20
	83-97	Rear Brake Pad	With Bendix 2.88 caliper	0225.10 or 0225.20
S1900 Bus	82-89	Front Brake Pad	With Bendix 2.88 caliper	0225.10 or 0225.20
	82-89	Rear Brake Pad	With Bendix 2.88 caliper	0225.10 or 0225.20
1950 Series	85-97	Front Brake Pad	With Bendix 3.38/2.60 caliper	0184.10 or 0184.20
	85-97	Rear Brake Pad	With Bendix 3.38/2.60 caliper	0184.10 or 0184.20
	85-97	Front Brake Pad	With Bendix 2.88 caliper	0225.10 or 0225.20
	85-97	Rear Brake Pad	With Bendix 2.88 caliper	0225.10 or 0225.20
2000 Series S Models	79-86	Front Brake Pad	With Bendix 2.88 caliper	0225.10 or 0225.20
	79-86	Rear Brake Pad	With Bendix 2.88 caliper	0225.10 or 0225.20
3000 Series Bus	98-07	Front Brake Pad	3000FE, 3400,3600SC,3800SC With Bosch Pinslider caliper	0786.10* or 0786.11*
	98-07	Rear Brake Pad	3000FE, 3400,3600SC,3800SC With Bosch Pinslider caliper	0786.10* or 0786.11*
	90-97	Front Brake Pad	300FE,3400,3600 mini, 3800 With Bendix 3.36 With o wear sensors	0184.10 or 0184.20
	90-97	Rear Brake Pad	300FE,3400,3600 mini, 3800 With Bendix 3.36 With o wear sensors	0184.10 or 0184.20
	90-97	Front Brake Pad	300FE,3400,3600 mini, 3800 With Bendix 2.88 caliper	0225.10 or 0225.20
	90-97	Rear Brake Pad	300FE,3400,3600 mini, 3800 With Bendix 2.88 caliper	0225.10 or 0225.20
4000 Series Trucks	98-07	Front Brake Pad	4200, 4300 4400, 4600 4700,4700LP,4900LP	0786.10* or 0786.11*
	98-07	Rear Brake Pad	4200, 4300 4400, 4600 4700,4700LP,4900LP	0786.10* or 0786.11*
	90-97	Front Brake Pad	4600,4600LP,4700,4700LP,4800,4900 With Bendix 3.36 With o wear sensors	0184.10 or 0184.20
	90-97	Rear Brake Pad	4600,4600LP,4700,4700LP,4800,4900 With Bendix 3.36 With o wear sensors	0184.10 or 0184.20
	90-97	Front Brake Pad	4600,4600LP,4700,4700LP,4800,4900 With Bendix 2.88 caliper	0225.10 or 0225.20
	90-97	Rear Brake Pad	4600,4600LP,4700,4700LP,4800,4900 With Bendix 2.88 caliper	0225.10 or 0225.20
7000 Series	79-92	Front Brake Pad	With Bendix 3.36 With o wear sensors	0184.10 or 0184.20
	79-92	Rear Brake Pad	With Bendix 3.36 With o wear sensors	0184.10 or 0184.20
	79-92	Front Brake Pad	With Bendix 2.88 caliper	0225.10 or 0225.20
	79-92	Rear Brake Pad	With Bendix 2.88 caliper	0225.10 or 0225.20
Various		381.089.20	Fits ITE Rotor number 3531661C2	381.089.20
		381.082.20	Fits ITE Rotor number 3531662C2	381.082.20
		381.113.20	Fits ITE Rotor number 3531663C2	381.113.20

*To determine proper part: 0786.10/20=66mm caliper/0786.11/21=73mm caliper

Application	Year	Position	Description	PF Part Number
THOMAS BUILT SCHOOL BUS				
Freightliner/ Navistar chassis With Bosch Pinslider caliper*	99-07	Front Brake Pad		0786.10 or 0786.20
	99-07	Rear Brake Pad		0786.11 or 0786.21
Freightliner chassis with Bendix 3.38/2.60 caliper	to 98	Front Brake Pad		0184.10 or 0184.20
	to 98	Rear Brake Pad		0184.10 or 0184.20
Navistar chasis with Bendix 2.88 caliper	to 98	Front Brake Pad		0225.10 or 0225.20
	to 98	Rear Brake Pad		0225.10 or 0225.20
Ford chasis with Dayton 2.88 caliper	to 98	Front Brake Pad		0236.20
	to 98	Rear Brake Pad		0236.20
Ford chasis with Dayton 2.50 caliper	to 98	Front Brake Pad		0224.10 or 0224.20
	to 98	Rear Brake Pad		0224.10 or 0224.20
FS65	00-07	Front Brake Pad	With Bosch Pinslider Caliper	0786.10 or 0786.20
	00-07	Rear Brake Pad	With Bosch Pinslider Caliper	0786.10 or 0786.20
	95-00	Front Brake Pad	With Bendix 3.38/2.60 caliper	0184.10 or 0184.20
	95-00	Rear Brake Pad	With Bendix 3.38/2.60 caliper	0184.10 or 0184.20
	95-00	Front Brake Pad	With Bendix 2.88 caliper	0225.10 or 0225.20
HDX	00-07	Rear Brake Pad	With Bendix 2.88 caliper	0225.10 or 0225.20
	00-07	Front Brake Pad	With Bosch Pinslider Caliper	0786.10 or 0786.20
	00-07	Rear Brake Pad	With Bosch Pinslider Caliper	0786.11 or 0786.21
	89-00	Front Brake Pad	With Bendix 3.38/2.60 caliper	0184.10 or 0184.20
	89-00	Rear Brake Pad	With Bendix 3.38/2.60 caliper	0184.10 or 0184.20
Minotour	89-00	Front Brake Pad	With Bendix 2.88 caliper	0225.10 or 0225.20
	89-00	Rear Brake Pad	With Bendix 2.88 caliper	0225.10 or 0225.20
	00-01	Front Brake Pad	Ford Chassis with rear rotor	0655.10 or .20
	00-01	Rear Brake Pad	Ford Chassis with rear rotor	0702.20
	95-00	Front Brake Pad	Ford chassis with rear drum	0655.10 or .20
	88-98	Front Brake Pad	Ford Chasis with four wheel rotor	0411.10 or .20
	88-98	Rear Brake Pad	Ford Chasis with four wheel rotor	0411.10 or .20
Minotour E350 DRW	92-94	Front Brake Pad	Ford chasis with rear drum	0557.20
	to 91	Front Brake Pad	Ford chasis with rear drum	0450.20
	79-97	Front Brake Pad	GM chassis	0149.20
	95-01	Front V2 Rotor Assy.	Two Piece Hub and Rotor assembly	329.201.75 V2 Version
Transit Liner -EF	95-01	Front V2 Repl. Rotor	Replacement rotor and hardware for above	329.30.0043.75 V2 Version
	76-94	Front Rotor Assy.	1-pc Front Rotor	318.094.01
Transit Liner -EF	82-97	Front Brake Pad	With Bendix 3.38/2.60 caliper	0184.10 or 0184.20
	82-97	Rear Brake Pad	With Bendix 3.38/2.60 caliper	0184.10 or 0184.20

*To determine proper part: 0786.10=66mm caliper/0786.11=73mm caliper

Application	Year	Position	Description	PF Part Number
	82-97	Front Brake Pad	With Bendix 2.88 caliper	0225.10 or 0225.20
	82-97	Rear Brake Pad	With Bendix 2.88 caliper	0225.10 or 0225.20
Vista (Thomas Built)	79-98	Front Brake Pad	With Bendix 2.88 caliper	0225.10 or 0225.20
	79-98	Rear Brake Pad	With Bendix 2.88 caliper	0225.10 or 0225.20
	79-98	Front Brake Pad	With Bendix 3.38/2.60 caliper	0184.10 or 0184.20
	79-98	Rear Brake Pad	With Bendix 3.38/2.60 caliper	0184.10 or 0184.20

*To determine proper part: 0786.10=66mm caliper/0786.11=73mm caliper

BUS APPLICATIONS FOR BENDIX BRAKE PADS

BLUE BIRD

Table 1-7: Brake Pads - Blue Bird

Application	Position	Part Number
Blue Bird - TC2000 with Disc Brakes (1998 - 2004)	Front & Rear	E111-0225-0
Blue Bird - TC2000 with Disc Brakes (1998 - 2004)	Front & Rear	E111-0786-0
Blue Bird - TC2000 with Disc Brakes (1998 - 2004)	Front & Rear	E111-0786-1
Blue Bird - TC2000 with Disc Brakes (1998 - 2004)	Front & Rear	E111-0769-0

CHEVROLET

Table 1-8: Brake Pads - Chevrolet

Application	Position	Part Number
Chevrolet - B6P042 School Bus with Front Disc Brakes (1979 - 1991)	Front & Rear	E111-0225-0
Chevrolet - B6P042 School Bus with Front Disc Brakes (1979 - 1991)	Front & Rear	E109-0225-0
Chevrolet - B6P042 School Bus with Front Disc Brakes (1979 - 1991)	Front & Rear	E111-0224-0
Chevrolet - B6P042 School Bus with Front Disc Brakes (1979 - 1991)	Front & Rear	E109-0224-0
Chevrolet - B7T042 School Bus with Disc Brakes (1993 - 2002)	Front & Rear	E111-0225-0
Chevrolet - B7T042 School Bus with Disc Brakes (1993 - 2002)	Front & Rear	E109-0225-0
Chevrolet - B7T042 School Bus with Disc Brakes (1993 - 2002)	Front & Rear	E111-0224-0
Chevrolet - B7T042 School Bus with Disc Brakes (1993 - 2002)	Front	E109-0224-0

FORD

Table 1-9: Brake Pads - Ford

Application	Position	Part Number
Ford - B600 Bus with Front Disc Brakes (1984 - 1985), (1986), (1987 - 1995)	Front	E109-0224-0
Ford - B600 Bus with Front Disc Brakes (1984 - 1985), (1986), (1987 - 1995)	Front	E111-0224-0
Ford - B600 Bus with Front Disc Brakes (1986), (1987 - 1995)	Front	E109-0236-0
Ford - B600 Bus with Front Disc Brakes (1986), (1987 - 1995)	Front	E111-0236-0
Ford - B700 Bus with Front Disc Brakes (1984 - 1986), (1987 - 1995)	Front	E109-0224-0
Ford - B700 Bus with Front Disc Brakes (1984 - 1986), (1987 - 1995)	Front	E111-0224-0
Ford - B700 Bus with Front Disc Brakes (1984 - 1986), (1987 - 1995)	Front	E109-0236-0
Ford - B700 Bus with Front Disc Brakes (1984 - 1986), (1987 - 1995)	Front	E111-0236-0
Ford - E450, 47 (1 Ton) Super Duty Van & Cutaway (1996 - 2007)	Front & Rear	E111-0411-0
Ford - E450, 47 (1 Ton) Super Duty Van & Cutaway (2008 - 2010)	Front	E111-1328-0
Ford - E450, 47 (1 Ton) Super Duty Van & Cutaway (2008 - 2010)	Rear	E111-1330-0

INTERNATIONAL/IC BUS

Table 1-10: Brake Pads - International/IC Bus

Application	Position	Part Number
International/IC Bus - BE, CE, HC, LC with Hydraulic Disc Brakes (2002 - 2008), (2009)	Front & Rear	E111-0786-0
International/IC Bus - BE, CE, HC, LC with Hydraulic Disc Brakes (2002 - 2008), (2009)	Front & Rear	E111-0786-1

International/IC Bus - BE, CE, HC, LC with Hydraulic Disc Brakes (2009), (2010)	Front & Rear	E111-0769-0
International/IC Bus 3000 Series - 3200, 3600, 3700, 3800, 3900FC School Bus with Hydraulic Disc Brakes (1990 - 1997)	Front & Rear	E111-0225-0
International/IC Bus 3000 Series - 3200, 3600, 3700, 3800, 3900FC School Bus with Hydraulic Disc Brakes (1990 - 1997)	Front & Rear	E111-0717-0
International/IC Bus 3000 Series - 3200, 3600, 3700, 3800, 3900FC School Bus with Hydraulic Disc Brakes (1998 - 2008), (2009)	Front & Rear	E111-0786-0
International/IC Bus 3000 Series - 3200, 3600, 3700, 3800, 3900FC School Bus with Hydraulic Disc Brakes (1998 - 2008), (2009)	Front & Rear	E111-0786-1
International/IC Bus 3000 Series - 3200, 3600, 3700, 3800, 3900FC School Bus with Hydraulic Disc Brakes (2009), (2010 - 2011)	Front & Rear	E111-0769-0

THOMAS BUILT

Table 1-11: Brake Pads - Thomas Built

Application	Position	Part Number
Thomas Built - Minotour Bus, Westport (2002 - 2007)	Front & Rear	E111-0769-0
Thomas Built - Minotour Bus, Westport (2002 - 2007)	Front & Rear	E111-0786-0
Thomas Built - Minotour Bus, Westport (2002 - 2007)	Front & Rear	E111-0786-1

BRAKE SHOES



For Brake Drums See pg. 1-48.



MERITOR BRAKE SHOE KITS

Table 1-12: Meritor New Lined Brake Shoes & Brake Shoe Kits

Part Number	Description	FMSI No.	Meritor Friction Mix	Minor Hardware Kit No.	New Lined Brake Shoe No.	New Shoe No. (Meritor Prod.)	New Shoe No. (Meritor After-Market)	Note
-------------	-------------	----------	----------------------	------------------------	--------------------------	------------------------------	-------------------------------------	------

15" x 4" EATON ES FRONT BRAKE SHOES



KSMA2121443E	15" x 4" Eaton ES Front Brake Shoe	1443TT	MA212	MKT 1308E	SMA2121443E	n/a	R700017	
KSMA3121443E	15" x 4" Eaton ES Front Brake Shoe	1443TT	MA312	MKT 1308E	SMA3121443E	n/a	R700017	

15" x 4" MERITOR Q PLUS FRONT BRAKE SHOES



KSMA2104702QP	15" x 4" Meritor Q Plus Front Brake Shoe	4702	MA210	KIT 8824HD	SMA2104702QP	A3222-M-2223	n/a	
KSMA2124702QP	15" x 4" Meritor Q Plus Front Brake Shoe	4702	MA212	KIT 8824HD	SMA2124702QP	A3222-M-2223	n/a	
KSMA2124702QPBL	15" x 4" Meritor Q Plus Front Brake Shoe	4702	MA212	KIT 8824HD	SMA2124702QPBL	A3222-M-2223	n/a	New Lined Brake Shoe contains B-Lock shoe coating.
KSMA3104702QP	15" x 4" Meritor Q Plus Front Brake Shoe	4702	MA310	KIT 8824HD	SMA3104702QP	A3222-M-2223	n/a	
KSMA3124702QP	15" x 4" Meritor Q Plus Front Brake Shoe	4702	MA312	KIT 8824HD	SMA3124702QP	A3222-M-2223	n/a	
KSMA3124702QPBL	15" x 4" Meritor Q Plus Front Brake Shoe	4702	MA312	KIT 8824HD	SMA3124702QPBL	A3222-M-2223	n/a	New Lined Brake Shoe contains B-Lock shoe coating.
KSR3014702QP	15" x 4" Meritor Q Plus Front Brake Shoe	4702	R301	KIT 8824HD	SR3014702QP	A3222-M-2223	n/a	

16-1/2" x 5" EATON ES BRAKE SHOES

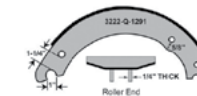


KSMA2124719R	16-1/2" x 5" Eaton ES Brake Shoe	4719	MA212	MKT 4709ES2-N	SMA2124719E	R700024	n/a	New Lined Brake Shoe for Drive or Steer Axle
KSMA2124719E	16-1/2" x 5" Eaton ES Brake Shoe	4719	MA212	R507094	SMA2124719E	R700024	n/a	New Lined Brake Shoe for Drive or Steer Axle

Information & Images Provided by Meritor

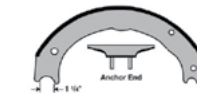
Part Number	Description	FMSI No.	Meritor Friction Mix	Minor Hardware Kit No.	New Lined Brake Shoe No.	New Shoe No. (Meritor Prod.)	New Shoe No. (Meritor After-Market)	Note
KSMA3124719R	16-1/2" x 5" Eaton ES Brake Shoe	4719	MA312	MKT 4709ES2-N	SMA3124719ES	R700024	n/a	New Lined Brake Shoe for Drive or Steer Axle
KSMA3124719E	16-1/2" x 5" Eaton ES Brake Shoe	4719	MA312	R507094	SMA3124719ES	R700024	n/a	New Lined Brake Shoe for Drive or Steer Axle

16-1/2" x 5" MERITOR Q BRAKE SHOES



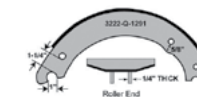
KSMA2104524Q	16-1/2" x 5" Meritor Q Brake Shoe	4524B	MA210	KIT 8000	SMA2104524Q	A3222-E-1383	n/a	
KSMA2124524Q	16-1/2" x 5" Meritor Q Brake Shoe	4524B	MA212	KIT 8000	SMA2124524Q	A3222-E-1383	n/a	
KSMA3104524Q	16-1/2" x 5" Meritor Q Brake Shoe	4524B	MA310	KIT 8000	SMA3104524Q	A3222-E-1383	n/a	
KSMA3124524Q	16-1/2" x 5" Meritor Q Brake Shoe	4524B	MA312	KIT 8000	SMA3124524Q	A3222-E-1383	n/a	
KSR3014524Q	16-1/2" x 5" Meritor Q Brake Shoe	4524B	R301	KIT 8000	SR3014524Q	A3222-E-1383	n/a	
KSR4034524Q	16-1/2" x 5" Meritor Q Brake Shoe	4524B	R403	KIT 8000	SR4034524Q	A3222-E-1383	n/a	

16-1/2" x 6" EATON ES BRAKE SHOES



KSMA2124725R	16-1/2" x 6" Eaton ES Brake Shoe	4725	MA212	MKT 4709ES2-N	SMA212 4725E	n/a	R700025	New Lined Brake Shoe for Drive or Steer Axle
KSMA2124725E	16-1/2" x 6" Eaton ES Brake Shoe	4725	MA212	R507094	SMA212 4725E	n/a	R700025	New Lined Brake Shoe for Drive or Steer Axle
KSMA3124725R	16-1/2" x 6" Eaton ES Brake Shoe	4725	MA312	MKT 4709ES2-N	SMA312 4725ES	n/a	R700025	New Lined Brake Shoe for Drive or Steer Axle
KSMA3124725E	16-1/2" x 6" Eaton ES Brake Shoe	4725	MA312	R507094	SMA312 4725ES	n/a	R700025	New Lined Brake Shoe for Drive or Steer Axle

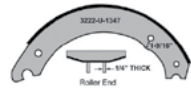
16-1/2" x 6" MERITOR Q BRAKE SHOES



KSMA2124514Q	16-1/2" x 6" Meritor Q Brake Shoe	4514G	MA212	KIT 8000	SMA2124514Q	A3222-C-1381	n/a	
--------------	-----------------------------------	-------	-------	----------	-------------	--------------	-----	--

Information & Images Provided by Meritor

Part Number	Description	FMSI No.	Meritor Friction Mix	Minor Hardware Kit No.	New Lined Brake Shoe No.	New Shoe No. (Meritor Prod.)	New Shoe No. (Meritor After-Market)	Note
KSMA3104514Q	16-1/2" x 6" Meritor Q Brake Shoe	4514G	MA310	KIT 8000	SMA3104514Q	A3222-C-1381	n/a	
KSMA3124514Q	16-1/2" x 6" Meritor Q Brake Shoe	4514G	MA312	KIT 8000	SMA3124514Q	A3222-C-1381	n/a	
KSR3014514Q	16-1/2" x 6" Meritor Q Brake Shoe	4514G	R301	KIT 8000	SR3014514Q	A3222-C-1381	n/a	
KSR4034514Q	16-1/2" x 6" Meritor Q Brake Shoe	4514G	R403	KIT 8000	SR4034514Q	A3222-C-1381	n/a	



16-1/2" x 6" MERITOR Q BRAKE SHOES WITH RELOCATED RETURN SPRING HOLE

KSMA2124514QR	16-1/2" x 6" Meritor Q Brake Shoe with Relocated Return Spring Hole	4514G	MA212	KIT 8080	SMA2124514QR	A3222-V-1348	n/a	
KSMA3104514QR	16-1/2" x 6" Meritor Q Brake Shoe with Relocated Return Spring Hole	4514G	MA310	KIT 8080	SMA3104514QR	A3222-V-1348	n/a	
KSMA3124514QR	16-1/2" x 6" Meritor Q Brake Shoe with Relocated Return Spring Hole	4514G	MA312	KIT 8080	SMA3124514QR	A3222-V-1348	n/a	
KSR3014514QR	16-1/2" x 6" Meritor Q Brake Shoe with Relocated Return Spring Hole	4514G	R301	KIT 8080	SR3014514QR	A3222-V-1348	n/a	
KSR4034514QR	16-1/2" x 6" Meritor Q Brake Shoe with Relocated Return Spring Hole	4514G	R403	KIT 8080	SR4034514QR	A3222-V-1348	n/a	

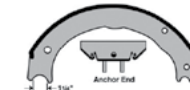


16-1/2" x 7" EATON BRAKE SHOES

KSMA2104311E	16-1/2" x 7" Eaton Brake Shoe	4311J	MA210	MKT 4311EHD-N	SMA2104311E	n/a	R4311	
KSMA2124311E	16-1/2" x 7" Eaton Brake Shoe	4311J	MA212	MKT 4311EHD-N	SMA2124311E	n/a	R4311	
KSMA2124311EBL	16-1/2" x 7" Eaton Brake Shoe	4311J	MA212	MKT 4311EHD-N	SMA2124311EBL	n/a	R4311	New Lined Brake Shoe contains B-Lock shoe coating.
KSMA3104311E	16-1/2" x 7" Eaton Brake Shoe	4311J	MA310	MKT 4311EHD-N	SMA3104311E	n/a	R4311	
KSMA3124311E	16-1/2" x 7" Eaton Brake Shoe	4311J	MA312	MKT 4311EHD-N	SMA3124311E	n/a	R4311	

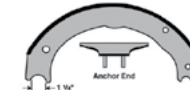
Information & Images Provided by Meritor

Part Number	Description	FMSI No.	Meritor Friction Mix	Minor Hardware Kit No.	New Lined Brake Shoe No.	New Shoe No. (Meritor Prod.)	New Shoe No. (Meritor After-Market)	Note
KSMA3124311EBL	16-1/2" x 7" Eaton Brake Shoe	4311J	MA312	MKT 4311EHD-N	SMA3124311EBL	n/a	R4311	New Lined Brake Shoe contains B-Lock shoe coating.
KSR3014311E	16-1/2" x 7" Eaton Brake Shoe	4311J	R301	MKT 4311EHD-N	SR3014311E	n/a	R4311	



16-1/2" x 7" EATON ES I BRAKE SHOES

KSMA2104709E1	16-1/2" x 7" Eaton ES I Brake Shoe	4709	MA210	MKT 4709ES-N	SMA2104709E1	n/a	R4709	
KSMA2124709E1	16-1/2" x 7" Eaton ES I Brake Shoe	4709	MA212	MKT 4709ES-N	SMA2124709E1	n/a	R4709	
KSMA3104709E1	16-1/2" x 7" Eaton ES I Brake Shoe	4709	MA310	MKT 4709ES-N	SMA3104709E1	n/a	R4709	
KSMA3124709E1	16-1/2" x 7" Eaton ES I Brake Shoe	4709	MA312	MKT 4709ES-N	SMA3124709E1	n/a	R4709	
KSR3014709E1	16-1/2" x 7" Eaton ES I Brake Shoe	4709	R301	MKT 4709ES-N	SR3014709E1	n/a	R4709	



16-1/2" x 7" EATON ES II BRAKE SHOES

KSMA2104709E2	16-1/2" x 7" Eaton ES II Brake Shoe	4709	MA210	MKT 4709ES2-N	KSMA2104709E2	n/a	R4709G2	
KSMA2124709E2	16-1/2" x 7" Eaton ES II Brake Shoe	4709	MA212	MKT 4709ES2-N	KSMA2124709E2	n/a	R4709G2	
KSMA2124709E2BL	16-1/2" x 7" Eaton ES II Brake Shoe	4709	MA212	MKT 4709ES2-N	KSMA2124709E-2BL	n/a	R4709G2	
KSMA3104709E2	16-1/2" x 7" Eaton ES II Brake Shoe	4709	MA310	MKT 4709ES2-N	KSMA3104709E2	n/a	R4709G2	
KSMA2104709E2	16-1/2" x 7" Eaton ES II Brake Shoe	4709	MA210	MKT 4709ES2-N	KSMA2104709E2	n/a	R4709G2	
KSMA2124709E2	16-1/2" x 7" Eaton ES II Brake Shoe	4709	MA212	MKT 4709ES2-N	KSMA2124709E2	n/a	R4709G2	
KSMA2124709E2BL	16-1/2" x 7" Eaton ES II Brake Shoe	4709	MA212	MKT 4709ES2-N	KSMA2124709E-2BL	n/a	R4709G2	
KSMA3104709E2	16-1/2" x 7" Eaton ES II Brake Shoe	4709	MA310	MKT 4709ES2-N	KSMA3104709E2	n/a	R4709G2	

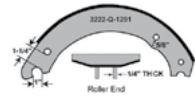


16-1/2" x 7" MERITOR Q BRAKE SHOES

KSMA2104515Q	16-1/2" x 7" Meritor Q Brake Shoe	4515G	MA210	KIT 8000	SMA2104515Q	A91-3222-S-1293	n/a	
--------------	-----------------------------------	-------	-------	----------	-------------	-----------------	-----	--

Information & Images Provided by Meritor

Part Number	Description	FMSI No.	Meritor Friction Mix	Minor Hardware Kit No.	New Lined Brake Shoe No.	New Shoe No. (Meritor Prod.)	New Shoe No. (Meritor After-Market)	Note
KSMA2124515Q	16-1/2" x 7" Meritor Q Brake Shoe	4515G	MA212	KIT 8000	SMA2124515Q	A91-3222-S-1293	n/a	
KSMA2124515QBL	16-1/2" x 7" Meritor Q Brake Shoe	4515G	MA212	KIT 8000	SMA2124515QBL	A91-3222-S-1293	n/a	New Lined Brake Shoe contains B-Lock shoe coating.
KSMA3104515Q	16-1/2" x 7" Meritor Q Brake Shoe	4515G	MA310	KIT 8000	SMA3104515Q	A91-3222-S-1293	n/a	
KSMA3124515Q	16-1/2" x 7" Meritor Q Brake Shoe	4515G	MA312	KIT 8000	SMA3124515Q	A91-3222-S-1293	n/a	
KSR3014515Q	16-1/2" x 7" Meritor Q Brake Shoe	4515G	R301	KIT 8000	SR3014515Q	A91-3222-S-1293	n/a	
KSR4034515Q	16-1/2" x 7" Meritor Q Brake Shoe	4515G	R403	KIT 8000	SR4034515Q	A91-3222-S-1293	n/a	
PKSMA2104515Q	16-1/2" x 7" Meritor Q Brake Shoe - Price Point Shoes & Hardware	4515G	MA210	MKT 4515Q-N	PSMA2104515Q	n/a	R4515	

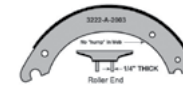


16-1/2" x 7" MERITOR Q BRAKE SHOES - HIGH END

PKSMA2124515Q	16-1/2" x 7" Meritor Q Brake Shoe - Price Point Shoes & Hardware	4515G	MA212	MKT 4515Q-N	PSMA2124515Q	n/a	R4515	
PKS-MA2124515QHD	16-1/2" x 7" Meritor Q Brake Shoe - Price Point Shoes & Hardware	4515G	MA212	MKT 4515QHD-N	PSMA2124515Q	n/a	R4515	
PKSMA2124515QBL	16-1/2" x 7" Meritor Q Brake Shoe - Price Point Shoes & Hardware	4515G	MA212	MKT 4515Q-N	PSMA2124515QBL	n/a	R4515	New Lined Brake Shoe contains B-Lock shoe coating.
PKSMA3104515Q	16-1/2" x 7" Meritor Q Brake Shoe - Price Point Shoes & Hardware	4515G	MA310	MKT 4515Q-N	PSMA3104515Q	n/a	R4515	
PKSMA3124515Q	16-1/2" x 7" Meritor Q Brake Shoe - Price Point Shoes & Hardware	4515G	MA312	MKT 4515Q-N	PSMA3124515Q	n/a	R4515	
PKSMA3124515QBL	16-1/2" x 7" Meritor Q Brake Shoe - Price Point Shoes & Hardware	4515G	MA312	MKT 4515Q-N	PSMA3124515QBL	n/a	R4515	New Lined Brake Shoe contains B-Lock shoe coating.
PKSR3014515Q	16-1/2" x 7" Meritor Q Brake Shoe - Price Point Shoes & Hardware	4515G	R301	MKT 4515Q-N	PSR3014515Q	n/a	R4515	

Information & Images Provided by Meritor

Part Number	Description	FMSI No.	Meritor Friction Mix	Minor Hardware Kit No.	New Lined Brake Shoe No.	New Shoe No. (Meritor Prod.)	New Shoe No. (Meritor After-Market)	Note
16-1/2" x 7" MERITOR Q PLUS BRAKE SHOES								
KSMA2104707QP	16-1/2" x 7" Meritor Q Plus Brake Shoe	4707	MA210	KIT 8000HD	SMA2104707QP	A19-3222-D-2006	n/a	
KSMA2124707QP	16-1/2" x 7" Meritor Q Plus Brake Shoe	4707	MA212	KIT 8000HD	SMA2124707QP	A19-3222-D-2006	n/a	
KSMA2124707QPBL	16-1/2" x 7" Meritor Q Plus Brake Shoe	4707	MA212	KIT 8000HD	SMA2124707QPBL	A19-3222-D-2006	n/a	New Lined Brake Shoe contains B-Lock shoe coating.
KSMA3104707QP	16-1/2" x 7" Meritor Q Plus Brake Shoe	4707	MA310	KIT 8000HD	SMA3104707QP	A19-3222-D-2006	n/a	
KSMA3124707QP	16-1/2" x 7" Meritor Q Plus Brake Shoe	4707	MA312	KIT 8000HD	SMA3124707QP	A19-3222-D-2006	n/a	
KSMA3124707QPBL	16-1/2" x 7" Meritor Q Plus Brake Shoe	4707	MA312	KIT 8000HD	SMA3124707QPBL	A19-3222-D-2006	n/a	New Lined Brake Shoe contains B-Lock shoe coating.
KSR3014707QP	16-1/2" x 7" Meritor Q Plus Brake Shoe	4707	R301	KIT 8000HD	SR3014707QP	A19-3222-D-2006	n/a	
KSR4034707QP	16-1/2" x 7" Meritor Q Plus Brake Shoe	4707	R403	KIT 8000HD	SR4034707QP	A19-3222-D-2006	n/a	

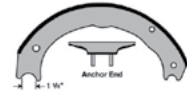


16-1/2" x 7" MERITOR Q PLUS BRAKE SHOES HIGH END

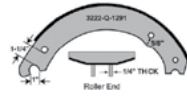
PKSMA2104707QP	16-1/2" x 7" Meritor Q Plus Brake Shoe - Price Point Shoes & Hardware	4707	MA210	MKT 4515QHD-N	PSMA2104707QP	n/a	R4707	
PKSMA2124707QP	16-1/2" x 7" Meritor Q Plus Brake Shoe - Price Point Shoes & Hardware	4707	MA212	MKT 4515QHD-N	PSMA2124707QP	n/a	R4707	
PKSMA2124707QP-BL	16-1/2" x 7" Meritor Q Plus Brake Shoe - Price Point Shoes & Hardware	4707	MA212	MKT 4515QHD-N	PSMA2124707QP-BL	n/a	R4707	New Lined Brake Shoe contains B-Lock shoe coating.
PKSMA3104707QP	16-1/2" x 7" Meritor Q Plus Brake Shoe - Price Point Shoes & Hardware	4707	MA310	MKT 4515QHD-N	PSMA3104707QP	n/a	R4707	
PKSMA3124707QP	16-1/2" x 7" Meritor Q Plus Brake Shoe - Price Point Shoes & Hardware	4707	MA312	MKT 4515QHD-N	PSMA3124707QP	n/a	R4707	
PKSR3014707QP	16-1/2" x 7" Meritor Q Plus Brake Shoe - Price Point Shoes & Hardware	4707	R301	MKT 4515QHD-N	PSR3014707QP	n/a	R4707	

Information & Images Provided by Meritor

Part Number	Description	FMSI No.	Meritor Friction Mix	Minor Hardware Kit No.	New Lined Brake Shoe No.	New Shoe No. (Meritor Prod.)	New Shoe No. (Meritor After-Market)	Note
-------------	-------------	----------	----------------------	------------------------	--------------------------	------------------------------	-------------------------------------	------

**16-1/2" x 8-5/8" EATON ES BRAKE SHOES**

KSMA3124726R	16-1/2" x 8-5/8" Eaton ES Brake Shoe	4707	MA312	MKT 4709ES2-N	SMA3124726ES	R700026	n/a	
--------------	--------------------------------------	------	-------	---------------	--------------	---------	-----	--

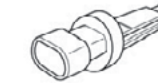
**16-1/2" x 8-5/8" MERITOR Q BRAKE SHOES**

KSMA2124551Q	16-1/2" x 8-5/8" Meritor Q Brake Shoe	4551B	MA212	KIT 8000HD	SMA2124551Q	A3222-T-1346	n/a	
KSR3014551Q	16-1/2" x 8-5/8" Meritor Q Brake Shoe	4551B	R301	KIT 8000HD	SR3014551Q	A3222-T-1346	n/a	

Information & Images Provided by Meritor

HYDRAULIC BRAKE LINES & FITTINGS

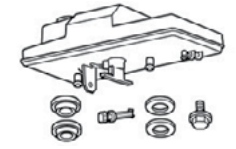
S4789010540



S4684139212



S4519009252



R950055



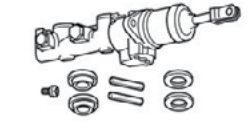
S4519004742



S4008508440



R950057



R950056



S4519009242

HPB MASTER CYLINDER ASSEMBLY

Table 1-13: HPB Master Cylinder Assembly

Part Number	Description
-------------	-------------

HPB MASTER CYLINDER PARTS

R950055	HPB Reservoir Kit - contains master cylinder reservoir, fluid level switch, 2 rubber grommets & washers. Cap not included. For bus applications only.
R950056	HPB Cylinder Kit - contains master cylinder, screws, 2 rubber grommets & washers, 2 roll pins.
R950057	HPB Pin Kit - contains 2 roll pins
S4519009242	HPB Grommet Kit - contains 2 rubber grommets
S4519009252	HPB Clevis Pin - contains one master cylinder clevis pin
S4008508440	HPB Travel Switch Kit - contains one o-ring, & 2 screws; for vehicles built after 2006.
S4008509150	HPB Cap - contains one master cylinder cap; for bus & medium duty truck applications.
S4519004742	HPB Cap - contains one master cylinder cap; for bus & medium duty truck applications.
S4684139212	HPB Fluid Switch - contains one fluid level switch
S4789010540	HPB Bracket - use with master cylinder 468 411 005 0 & reservoir 468 413 020 2; for bus applications.



STEEL BRAKE LINES AND FITTINGS - FOR DOMESTIC VEHICLES

Table 1-14: Steel Brake Lines

Part Number	Description
R45B308	8" - 3/16" Outside Diameter - Blue Label Steel Brake Line - 10 per tube
R45B408	8" - 1/4" Outside Diameter - Yellow label - 10 per tube
R45B608	8" - 3/8" Outside Diameter - Green label - 5 per tube
R45B508	8" - 5/16" Outside Diameter - Orange label - 5 per tube
R45B312	12" - 3/16" Outside Diameter - Blue Label Steel Brake Line - 10 per tube
R45B412	12" - 1/4" Outside Diameter - Yellow label - 10 per tube
R45B512	12" - 5/16" Outside Diameter - Orange label - 5 per tube
R45B612	12" - 3/8" Outside Diameter - Green label - 5 per tube
R45B420	20" - 1/4" Outside Diameter - Yellow label - 10 per tube
R458620	20" - 3/8" Outside Diameter - Green label - 5 per tube
R45B520	20" - 5/16" Outside Diameter - Orange label - 5 per tube
R45B320	20" - 3/16" Outside Diameter - Blue Label Steel Brake Line - 10 per tube
R45B530	30" - 5/16" Outside Diameter - Orange label - 5 per tube
R45B330	30" - 3/16" Outside Diameter - Blue Label Steel Brake Line - 10 per tube
R45B630	30" - 3/8" Outside Diameter - Green label - 5 per tube
R45B430	30" - 1/4" Outside Diameter - Yellow label - 10 per tube
R458640	40" - 3/8" Outside Diameter - Green label - 5 per tube
R45B540	40" - 5/16" Outside Diameter - Orange label - 5 per tube
R45B440	40" - 1/4" Outside Diameter - Yellow label - 10 per tube
R458340	40" - 3/16" Outside Diameter - Blue Label Steel Brake Line - 10 per tube
R45B551	51" - 5/16" Outside Diameter - Orange label - 5 per tube
R45B451	51" - 1/4" Outside Diameter - Yellow label - 10 per tube
R45B351	51" - 3/16" Outside Diameter - Blue Label Steel Brake Line - 10 per tube
R45B651	51" - 3/8" Outside Diameter - Green label - 5 per tube
R45B660	60" - 3/8" Outside Diameter - Green label - 5 per tube
R45B560	60" - 5/16" Outside Diameter - Orange label - 5 per tube
R45B460	60" - 1/4" Outside Diameter - Yellow label - 10 per tube
R45B360	60" - 3/16" Outside Diameter - Blue Label Steel Brake Line - 10 per tube

Information & Images Provided by Meritor



STEEL BRAKE ADAPTER LINES

- All adapter lines are 8" long.
- Convert to 3/16" and 1/4" Brake Lines to fit larger- than-standard openings.

Table 1-15: Steel Brake Adapter Lines

Part Number	Description	Tube Outside Diameter	Nut Color	Thread Sizes	Application
R458564	Hydraulic Brake Adapter Line - Red Nut	3/16"	Red	3/8"-24, 7/16"-24	General Motors
R45B565	Hydraulic Brake Adapter Line - Black Nut	3/16"	Black	3/8"-24, 1/2"-20	Ford
R458566	Hydraulic Brake Adapter Line - Green Nut	3/16"	Green	3/8"-24, 1/2"-20	General Motors
R4S8S67	Hydraulic Brake Adapter Line - Olive Nut	3/16"	Olive	3/8"-24, 9/16"-18	Ford
R45B568	Hydraulic Brake Adapter Line - Blue Nut	1/4"	Blue	7/16"-24, 9/16"-18	General Motors
R458569	Hydraulic Brake Adapter Line - Brass Nut	1/4"	Brass	7/16"-24, 7/16"-24	General Motors
R458570	Hydraulic Brake Adapter Line - Silver Nut	1/4"	Silver	7/16"-24, 1/2"-20	Ford

STEEL BRAKE ADAPTER LINES



Compression Union Air



Hydraulic Steel Brake Line Union

STEEL BRAKE LINE FITTINGS - FOR DOMESTIC VEHICLES

Table 1-16: Steel Brake Line Fittings

Part Number	Description
STEEL BRAKE LINE FITTINGS - AIR	
R458643	Air - Compression Union - for 3/16" Copper Air Brake Line
A4S8644	Air - Compression Union - for 1/4" Copper Air Brake Line
R458645	Air - Compression Union - for 5/16" Copper Air Brake Line
R458646	Air - Compression Union - for 3/8" Copper Air Brake Line
STEEL BRAKE LINE FITTINGS - HYDRAULIC	
R458639	Hydraulic Steel Brake Line Union - for 3/16" Hydraulic Brake Line
R4S8640	Hydraulic Steel Brake Line Union - for 1/4" Hydraulic Brake Line
R458641	Hydraulic Steel Brake Line Union - for 5/16" Hydraulic Brake Line
R458642	Hydraulic Steel Brake Line Union - for 3/8" Hydraulic Brake Line

Information & Images Provided by Meritor



STEEL BRAKE LINES AND FITTINGS - FOR IMPORT VEHICLES

Table 1-17: Steel Brake Lines for Imported Vehicles

Description	Part Number for European vehicle (ISO & Bubble Flare)	Part Number for Japanese vehicle (Double Flare)	Part Number for British vehicle (ISO & Bubble Flare)
STEEL BRAKE LINES			
8" - import steel brake line	R457013680	R457013687	R457013694
12" - import steel brake line	R457013681	R457013688	R457013695
20" - import steel brake line	R457013682	R457013689	R457013696
30" - import steel brake line	R457013683	R457013690	R457013697
40" - import steel brake line	R457013684	R457013691	R45701369B
51" - import steel brake line	R457013685	R457013692	R457013699
60" - import steel brake line	R457013686	R457013693	R457013700



Compression Union Air



Hydraulic Steel Brake Line Union

STEEL BRAKE LINE FITTINGS - FOR IMPORT VEHICLES

Table 1-18: Steel Brake Line Fittings for Imported Vehicles

Part Number	Description	Tube Size	Thread Size
STEEL BRAKE LINE FITTINGS			
R457013701	European Nut - 3/16" Tube Size - M10 x 1.00 Thread Size	3/16"	M10 x 1.00
R457013702	Japanese Nut - 3/16" Tube Size - M10 x 1.00 Thread Size	3/16"	M10 x 1.00
R457013703	British Nut - 3/16" Tube Size - 3/8" -24 Thread Size	3/16"	3/8" -24

Information & Images Provided by Meritor

BRAKE HARDWARE



15" HARDWARE KITS

Table 1-19: 15" Eaton OE

Kit Part Number	Description	Item	QTY
EATON OE - 15" Eaton OE Hardware Kit - Front steer axle. Single anchor pin front brake. Services 1 brake.			
R507004	Return Spring	1	1
	Retainer Spring	2	1
	Brake Shoe Roller	3	2

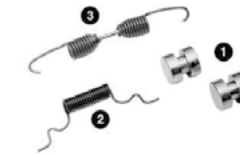


Table 1-20: 15" Eaton Aftermarket

Kit Part Number	Description	Item	QTY
EATON AFTERMARKET - 15" Eaton AfterMarket Hardware Kit - Front brakes.			
MKT1308E	Brake Shoe Roller	1	2
	Retainer Spring	2	1
	Return Spring	3	1

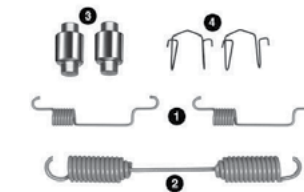


Table 1-21: 15" Eaton for FMSI 4729

Kit Part Number	Description	Item	QTY
EATON FOR FMSI 4729 - 15" Eaton Hardware Kit for FMSI 4729 - Front steer axle. Single anchor pin front brake. Services 1 brake.			
R615026	Retainer Spring	1	2
	Return Spring	2	1
	Brake Shoe Roller	3	2
	Roller Retainer	4	2

Information & Images Provided by Meritor

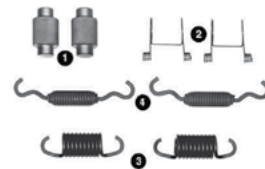


Table 1-22: 15" Eaton Steer Axle ES (Reduced Envelope)

Kit Part Number	Description	Item	QTY
R507086	Brake Shoe Roller	1	2
	Roller Retainer	2	2
	Return Spring	3	2
	Retainer Spring	4	2

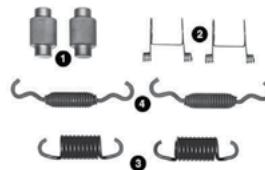


Table 1-23: 15" Eaton Drive Axle ES (Reduced Envelope)

Kit Part Number	Description	Item	QTY
R507083	Brake Shoe Roller	1	2
	Roller Retainer	2	2
	Return Spring	3	1
	Retainer Spring	4	2

Information & Images Provided by Meritor



Table 1-24: 15" Meritor Q - Overhaul

Kit Part Number	Description	Item	QTY
K1T8029	Anchor Pin	1	2
	Return Spring	2	1
	Retainer Spring	3	1
	Roller	4	2
	Locknut	5	2
	Washer	6	2
	Plate	7	1

MERITOR Q OVERHAUL - 15" Meritor Q OE Overhaul Hardware Kit - Front steer axles. Hardware kit for Meritor front (steer) axle Q brakes. Services 1 brake.



Table 1-25: 15" Meritor Q - Complete Overhaul

Kit Part Number	Description	Item	QTY
K1T8021	Anchor Pin	1	2
	Washer	2	2
	Locknut	3	2
	Hold Down Clip	4	2
	Hold Down Clip	5	2
	Capscrew	6	2
	Nut	7	2
	Return Spring	8	1
	Retainer Spring	9	1
	Bushing	10	2
	Seal	11	2
	Plate	12	1
	Roller	13	2

MERITOR Q COMPLETE OVERHAUL - 15" Meritor Q Complete Overhaul Hardware Kit - Front steer axles. Minor overhaul kit. Services 1 brake.

Information & Images Provided by Meritor

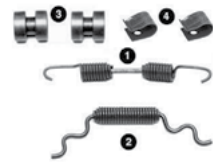


Table 1-26: 15" Meritor Q Offset Spider

Kit Part Number	Description	Item	QTY
R508030	Return Spring	1	1
	Retainer Spring	2	1
	Roller	3	2
	Hold Down Clip	4	2



Table 1-27: 15" Meritor Q Plus with TrackLok

Kit Part Number	Description	Item	QTY
K1T8847HDA	Anchor Pin	1	2
	Anchor Pin Bushing	2	2
	Retainer Spring	3	2
	Return Spring	4	1
	Roller	5	2
	Retainer	6	2



Table 1-28: 15" Meritor Q Plus - Front Steer Axle with Heavy Duty Spring

Kit Part Number	Description	Item	QTY
K1T8824HD	Brake Shoe Roller	1	2
	Roller Retainer	2	2
	Return Spring Pin	3	2
	Anchor Pin Bushing	4	2
	Anchor Pin	5	2
	Retainer Spring	6	2

Information & Images Provided by Meritor

16-1/2" HARDWARE KITS

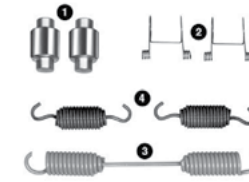


Table 1-29: 16-1/2" Eaton ES

Kit Part Number	Description	Item	QTY
MKT4709ESN	Brake Shoe Roller	1	2
	Roller Retainer	2	2
	Return Spring	3	1
	Retainer Spring	4	2



Table 1-30: 16-1/2" Eaton with Fabricated Brake Shoes

Kit Part Number	Description	Item	QTY
R507002	Return Spring	1	1
	Retainer Spring	2	2
	Brake Shoe Roller	3	2
	Roller Pin	4	2



Table 1-31: 16-1/2" Eaton with Heavy Duty Return Spring

Kit Part Number	Description	Item	QTY
MKT4311EHDN	Retainer Spring	1	2
	Return Spring	2	1
	Brake Shoe Roller	3	2
	Roller Pin	4	2

Information & Images Provided by Meritor

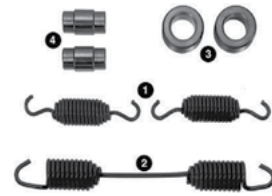


Table 1-32: 16-1/2" Eaton - Drive Axle with High Mount Brake Shoes

Kit Part Number	Description	Item	QTY
R507077	EATON - DRIVE AXLE WITH HIGH MOUNT BRAKE SHOES - 16-1/2" Eaton Drive Axle with High Mount Brake Shoes Hardware Kit - For use with "High Mount" brake shoes. Brake shoe has offset spring retainer pin. Used in some Ford applications. Services 1 brake.		
	Retainer Spring	1	2
	Return Spring	2	1
	Brake Shoe Roller	3	2
	Roller Pin	4	2

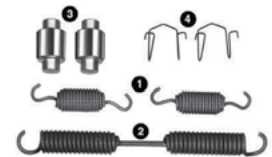


Table 1-33: 16-1/2" Eaton ES - Drive Axle

Kit Part Number	Description	Item	QTY
R507057	EATON ES DRIVE AXLE - 16-1/2" Eaton ES Drive Axle OE Hardware Kit - Drive axle. Can only be used with Eaton "ES" camshafts. Services 1 brake.		
	Retainer Spring	1	2
	Return Spring	2	1
	Brake Shoe Roller	3	2
	Roller Retainer	4	2

Information & Images Provided by Meritor



Table 1-34: 16-1/2" Eaton ES - Drive Axle with Cast Brake Shoes - Complete Overhaul

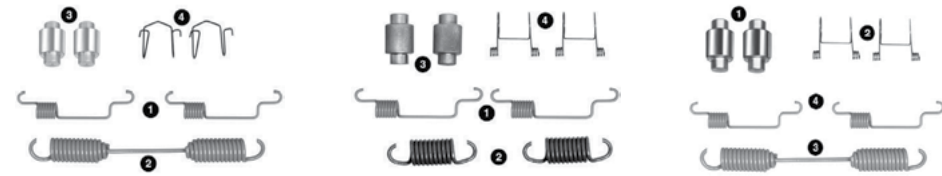
Kit Part Number	Description	Item	QTY
R507084	EATON ES - DRIVE AXLE WITH CAST BRAKE SHOES - COMPLETE OVERHAUL - 16-1/2" Eaton ES Brake with Cast Shoes Complete Overhaul Hardware Kit - Drive axle. Severe service brake with cast shoes. Services 1 brake.		
	Anchor Pin	1	2
	Lock Screw	2	2
	Washer	3	4
	Snap Ring	4	4
	Shoe Bushing	5	4
	Anchor Pin Bushing	6	2
	Brake Shoe Roller	7	2
	Roller Pin	8	2
	Lock Pin	9	2
Return Spring	10	1	



Table 1-35: 16-1/2" Eaton ES - Drive Axle with Fabricated Brake Shoes - Complete Overhaul

Kit Part Number	Description	Item	QTY
R507085	EATON ES - DRIVE AXLE WITH FABRICATED BRAKE SHOES - COMPLETE OVERHAUL - 16-1/2" Eaton ES Brake with Fabricated Shoes Complete Overhaul Hardware Kit - Drive axle. Severe service brake with fabricated shoes. Services 1 brake.		
	Brake Shoe Roller	1	2
	Lock Screw	2	2
	Washer	3	4
	Snap Ring	4	4
	Anchor Pin Bushing	5	2
	Brake Shoe Roller	6	2
	Roller Retainer	7	2
	Return Spring Pin	8	2
Return Spring	9	1	

Information & Images Provided by Meritor



R507064

R507094

MKT409ES2N

Table 1-36: 16-1/2" Eaton ES II - OE Front Axle

Kit Part Number	Description	Item	QTY
R507064	Retainer Spring	1	2
	Return Spring	2	1
	Brake Shoe Roller	3	2
	Roller Retainer	4	2

EATON ES II FRONT AXLE - OE KIT - 16-1/2" Eaton ES II Front Axle OE Hardware Kit - Front steer axle. Can only be used with Eaton "ES" camshafts. Services 1 brake.

R507094	Retainer Spring	1	2
	Return Spring	2	2
	Brake Shoe Roller	3	2
	Roller Retainer	4	2

EATON ES II - AFTERMARKET KIT - 16-1/2" Eaton ES II AfterMarket Hardware Kit - Drive axle. For use with new ES-II, No-Tab shoe with retainer spring holes in web. NOTE: Install retainer springs with coil end up. Can only be used with Eaton "ES" camshafts. Services 1 brake. Also available bagged as part number MKT4709ES2-B.

MK-T409ES2N	Brake Shoe Roller	1	2
	Roller Retainer	2	2
	Return Spring	3	1
	Retainer Spring	4	2

Information & Images Provided by Meritor



Table 1-37: 16-1/2" Meritor Q - Complete Overhaul

Kit Part Number	Description	Item	QTY
K1T8000	Anchor Pin	1	2
	Return Spring	2	1
	Retainer Spring	3	2
	Brake Shoe Roller	4	2
	Anchor Pin Bushing	5	2
	Return Spring Pin	6	2
	Roller Retainer	7	2

MERITOR Q COMPLETE OVERHAUL - 16-1/2" Meritor Q Complete Overhaul Hardware Kit - Services all Q brake sizes, incl. Fruehauf, except those on front steer axles. For H.D. version see K1T8000HD. Services 1 brake.



Table 1-38: 16-1/2" Meritor Q with Heavy Duty Return Spring (kit without bushings)

Kit Part Number	Description	Item	QTY
K1T8000MBHD	Anchor Pin	1	2
	Brake Shoe Roller	2	2
	Anchor Pin Bushing	3	2
	Return Spring Pin	4	2
	Roller Retainer	5	2
	Return Spring	6	1
	Retainer Spring	7	2

Information & Images Provided by Meritor

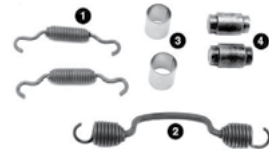


Table 1-39: 16-1/2" Meritor Q - Front Steer Axle (services clipped and hammerclaw cams)

Kit Part Number	Description	Item	QTY
K1T8080	Retainer Spring	1	2
	Return Spring	2	1
	Anchor Pin Bushing	3	2
	Anchor Pin	4	2

MERITOR Q - FRONT STEER AXLE (SERVICES CLIPPED AND HAMMERCLAW CAMS) - 16-1/2" Meritor Q Front Steer Axle Hardware Kit (services clipped and hammerclaw cams)



Table 1-40: 16-1/2" Meritor Q - Front Steer Axle - Complete Overhaul (services clipped and hammerclaw cams)

Kit Part Number	Description	Item	QTY
K1T8081	Return Spring	1	1
	Retainer Spring	2	2
	Anchor Pin	3	2
	Anchor Pin Bushing	4	2
	Brake Shoe Roller	5	2
	Roller Retainer	6	2
	Return Spring Pin	7	2

Information & Images Provided by Meritor

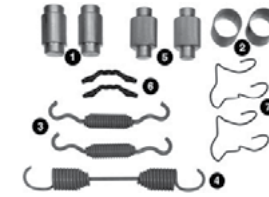


Table 1-41: 16-1/2" Intraxx, Meritor Q, Q Plus and Spicer XLII AfterMarket

Kit Part Number	Description	Item	QTY
MKT4515QN	Anchor Pin	1	2
	Anchor Pin Bushing	2	2
	Retainer Spring	3	2
	Return Spring	4	1
	Brake Shoe Roller	5	2
	Return Spring Pin	6	2
	Roller Retainer	7	2

Intraxx, Meritor Q, Q Plus and Spicer XLII AfterMarket - 16-1/2" Intraxx and Meritor Q, Q Plus and Spicer XLII AfterMarket Hardware Kit - Drive axle. Services multiple applications, except those on front heavy axles. For HD version see MKT4515QHD. Services 1 brake. Also available bagged as part number MKT4515Q-B.

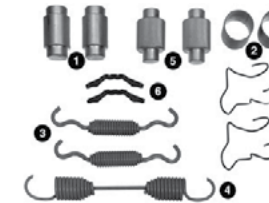


Table 1-42: 16-1/2" Intraxx, Meritor Q, Q Plus and Spicer XLII AfterMarket with Heavy Duty Return Spring

Kit Part Number	Description	Item	QTY
MKT4515HDN	Anchor Pin	1	2
	Anchor Pin Bushing	2	2
	Retainer Spring	3	2
	Return Spring	4	1
	Brake Shoe Roller	5	2
	Return Spring Pin	6	2
	Roller Retainer	7	2

Information & Images Provided by Meritor

BRAKE DRUMS



For Rotors See pg. 1-125



WEBB® BRAKE DRUMS

Table 1-43: Webb® Brake Drums

Part Number	Description	Weight (lb.)	Axle (lb.)
15" DRUMS			
71528B	Webb® Light Weight Vortex™ Brake Drum 15.00" x 4.00" Balanced	64.38	Steer
65551B	Webb® Brake Drum 15.00" x 5.00" Balanced	85.45	n/a
61950B	Webb® Brake Drum 15.00" x 6.00" Balanced	77.96	Steer
61991B	Webb® Brake Drum 15.00" x 8.62" Balanced	118.0	Drive
16.50" x 5.00" DRUMS			
65516B	Webb® Brake Drum 16.50" x 5.00" Balanced	80.9	Steer
65516B	Webb® Brake Drum 16.50" x 5.00" Balanced	80.9	Steer
65710B	Webb® Brake Drum 16.50" x 5.00" Balanced	96.61	Steer
65175B	Webb® Brake Drum 16.50" x 5.00" Balanced	102.71	Steer
65177B	Webb® Brake Drum 16.50" x 5.00" Balanced	106.34	Steer
65163B	Webb® Brake Drum 16.50" x 5.00" Balanced	117.15	Steer
16.50" x 6.00" DRUMS			
65179B	Webb® Brake Drum 16.50" x 6.00" Balanced	110.13	Steer
65169B	Webb® Brake Drum 16.50" x 6.00" Balanced	115.0	Steer
65176B	Webb® Brake Drum 16.50" x 6.00" Balanced	118.11	Steer
65152B	Webb® Brake Drum 16.50" x 6.00" Balanced	120.14	Steer

Information & Images Provided by Webb®

Part Number	Description	Weight (lb.)	Axle (lb.)
16.50" x 7.00" DRUMS			
68958B	Webb® Brake Drum 16.50" x 7.00" Balanced	91.63	Drive
68981B	Webb® Brake Drum 16.50" x 7.00" Balanced	95.65	Drive
68981B	Webb® Brake Drum 16.50" x 7.00" Balanced	95.65	Drive
66873B	Webb® Brake Drum 16.50" x 7.00" Balanced	107.1	Drive
76864B	Webb® Brake Drum 16.50" x 7.00" Balanced	109.63	Drive
68918B	Webb® Brake Drum 16.50" x 7.00" Balanced	109.64	n/a
66864B	Webb® Brake Drum 16.50" x 7.00" Balanced	112.0	Drive
66353B	Webb® Brake Drum 16.50" x 7.00" Balanced	112.92	n/a
76884B	Webb® Light Weight Vortex™ Brake Drum 16.50" x 7.00" Balanced	114.35	Drive
65670B	Webb® Brake Drum 16.50" x 7.00" Balanced	117.0	Drive
66843B	Webb® Brake Drum 16.50" x 7.00" Balanced	121.0	n/a
16.50" x 8" OR MORE DRUMS			
66800B	Webb® Brake Drum 16.50" x 8.00" Balanced	118.77	Drive
76854B	Webb® Light Weight Vortex™ Brake Drum 16.50" x 8.62" Balanced	120.0	Drive
66812B	Webb® Brake Drum 16.50" x 10.00" Balanced	159.53	Drive

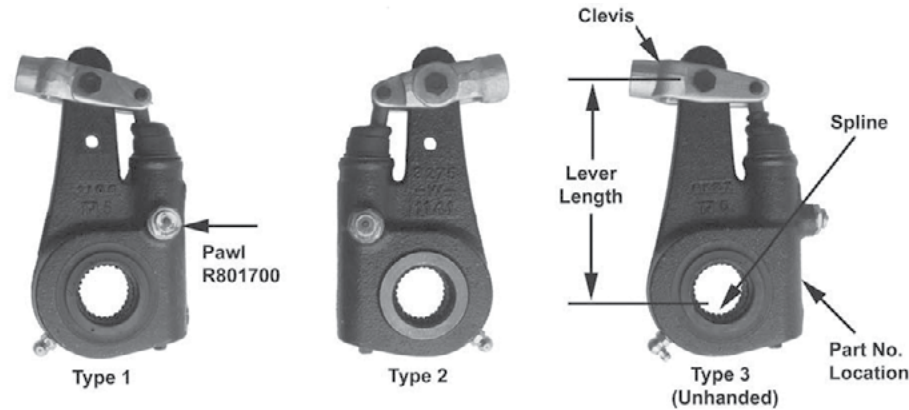
Information & Images Provided by Webb®

BRAKE SLACK ADJUSTERS

MERITOR SLACK ADJUSTERS

- The slack adjuster must be installed so the pawl can be removed during maintenance.

Note: Type 1, Type 2 and Type 3 indicate the location of the pawl assembly on the slack adjuster.



Note: Type 1, Type 2 and Type 3 indicate the location of the pawl assembly on the slack adjuster. The slack adjuster must be installed so the pawl can be removed during maintenance.

Table 1-44: Meritor Slack Adjusters

Part Number	Description	Clevis Kit Part Number	Kit Type	Unclevised Part Number	Spline Diameter/Number of Teeth	Lever Length	Clevis Type	Clevis Thread
R802002	Meritor Automatic Slack Adjuster Kit (Stroke-Sensing)	R810015LW	1	R803000	1-1/4"-10	5"	Offset	1/2"-20
R802003	Meritor Automatic Slack Adjuster Kit (Stroke-Sensing)	R810016LW	2	R803001	1-1/4"-10	5"	Offset	1/2"-20
R802000	Meritor Automatic Slack Adjuster Kit (Stroke-Sensing)	R810013LW	1	R803000	1-1/4"-10	5"	Straight	1/2"-20
R802001	Meritor Automatic Slack Adjuster Kit (Stroke-Sensing)	R810014LW	2	R803001	1-1/4"-10	5"	Straight	1/2"-20
R802032	Meritor Automatic Slack Adjuster Kit (Stroke-Sensing)	R810024	1	R803004	1-1/4"-10	5-1/2"	Offset	1/2"-20
R802033	Meritor Automatic Slack Adjuster Kit (Stroke-Sensing)	R810024	2	R803005	1-1/4"-10	5-1/2"	Offset	1/2"-20
R802030	Meritor Automatic Slack Adjuster Kit (Stroke-Sensing)	R810018	1	R803004	1-1/4"-10	5-1/2"	Straight	1/2"-20
R802031	Meritor Automatic Slack Adjuster Kit (Stroke-Sensing)	R810018	2	R803005	1-1/4"-10	5-1/2"	Straight	1/2"-20
R801001	Meritor Automatic Slack Adjuster Kit (Stroke-Sensing)	R810018	3	R803101	1-1/4"-10	5-1/2"	Straight	1/2"-20
R802022	Meritor Automatic Slack Adjuster Kit (Stroke-Sensing)	R810015LW	1	R803002	1-1/4"-10	5-1/2"	Offset	1/2"-20
R802023	Meritor Automatic Slack Adjuster Kit (Stroke-Sensing)	R810016LW	2	R803003	1-1/4"-10	5-1/2"	Offset	1/2"-20
R802020	Meritor Automatic Slack Adjuster Kit (Stroke-Sensing)	R810013LW	1	R803002	1-1/4"-10	5-1/2"	Straight	1/2"-20
R802021	Meritor Automatic Slack Adjuster Kit (Stroke-Sensing)	R810014LW	2	R803003	1-1/4"-10	5-1/2"	Straight	1/2"-20
R802042	Meritor Automatic Slack Adjuster Kit (Stroke-Sensing)	R810025	1	R803004	1-1/4"-10	5-1/2"	Offset	5/8"-18
R802048	Meritor Automatic Slack Adjuster Kit (Stroke-Sensing)	R810025	1	n/a	1-1/4"-10	5-1/2"	Offset	5/8"-19
R802043	Meritor Automatic Slack Adjuster Kit (Stroke-Sensing)	R810025	2	R803005	1-1/4"-10	5-1/2"	Offset	5/8"-20
R802049	Meritor Automatic Slack Adjuster Kit (Stroke-Sensing)	R810025	2	n/a	1-1/4"-10	5-1/2"	Offset	5/8"-21
R802040	Meritor Automatic Slack Adjuster Kit (Stroke-Sensing)	R810019	1	R803004	1-1/4"-10	5-1/2"	Straight	5/8"-22

Information & Images Provided by Meritor




Part Number	Description	Clevis Kit Part Number	Kit Type	Unclevised Part Number	Spline Diameter/Number of Teeth	Lever Length	Clevis Type	Clevis Thread
R802041	Meritor Automatic Slack Adjuster Kit (Stroke-Sensing)	R810019	2	R803005	1-1/4"-10	5-1/2"	Straight	5/8"-23
R801004	Meritor Automatic Slack Adjuster Kit (Stroke-Sensing)	R810019	3	R803101	1-1/4"-10	5-1/2"	Straight	5/8"-24
R802062	Meritor Automatic Slack Adjuster Kit (Stroke-Sensing)	R810024	1	R803010	1-1/4"-24	5-1/2"	Offset	1/2"-20
R802063	Meritor Automatic Slack Adjuster Kit (Stroke-Sensing)	R810024	2	R803011	1-1/4"-24	5-1/2"	Offset	1/2"-20
R802060	Meritor Automatic Slack Adjuster Kit (Stroke-Sensing)	R810018	1	R803010	1-1/4"-24	5-1/2"	Straight	1/2"-20
R802061	Meritor Automatic Slack Adjuster Kit (Stroke-Sensing)	R810018	2	R803011	1-1/4"-24	5-1/2"	Straight	1/2"-20
R801002	Meritor Automatic Slack Adjuster Kit (Stroke-Sensing)	R810018	3	R803102	1-1/4"-24	5-1/2"	Straight	1/2"-20
R802052	Meritor Automatic Slack Adjuster Kit (Stroke-Sensing)	R810015LW	1	R803008	1-1/4"-24	5-1/2"	Offset	1/2"-20
R802053	Meritor Automatic Slack Adjuster Kit (Stroke-Sensing)	R810016LW	2	R803009	1-1/4"-24	5-1/2"	Offset	1/2"-20
R802050	Meritor Automatic Slack Adjuster Kit (Stroke-Sensing)	R810013LW	1	R803008	1-1/4"-24	5-1/2"	Straight	1/2"-20
R802051	Meritor Automatic Slack Adjuster Kit (Stroke-Sensing)	R810014LW	2	R803009	1-1/4"-24	5-1/2"	Straight	1/2"-20
R801003	Meritor Automatic Slack Adjuster Kit (Stroke-Sensing)	R810019	3	R803102	1-1/4"-24	5-1/2"	Straight	5/8"-18
R802072	Meritor Automatic Slack Adjuster Kit (Stroke-Sensing)	R810025	1	R803010	1-1/4"-24	5-1/2"	Offset	5/8"-19
R802073	Meritor Automatic Slack Adjuster Kit (Stroke-Sensing)	R810025	2	R803011	1-1/4"-24	5-1/2"	Offset	5/8"-20
R802656	Meritor Automatic Slack Adjuster Kit (Stroke-Sensing)	R810025	1	R803070	1-1/4"-24	5-1/2"	Offset	5/8"-21
R802657	Meritor Automatic Slack Adjuster Kit (Stroke-Sensing)	R810025	2	R803071	1-1/4"-24	5-1/2"	Offset	5/8"-22
R802070	Meritor Automatic Slack Adjuster Kit (Stroke-Sensing)	R810019	1	R803010	1-1/4"-24	5-1/2"	Straight	5/8"-25
R802071	Meritor Automatic Slack Adjuster Kit (Stroke-Sensing)	R810019	2	R803011	1-1/4"-24	5-1/2"	Straight	5/8"-26
R802074	Meritor Automatic Slack Adjuster Kit (Stroke-Sensing)	R810019	1	R803014	1-1/4"-24	5-1/2"	Straight	5/8"-18
R802075	Meritor Automatic Slack Adjuster Kit (Stroke-Sensing)	R810019	2	R803015	1-1/4"-24	5-1/2"	Straight	5/8"-18
R802262	Meritor Automatic Slack Adjuster Kit (Stroke-Sensing)	R810015LW	1	R803016	1-1/2"-10	5"	Offset	1/2"-20
R802263	Meritor Automatic Slack Adjuster Kit (Stroke-Sensing)	R810016LW	2	R803017	1-1/2"-10	5"	Offset	1/2"-20
R802260	Meritor Automatic Slack Adjuster Kit (Stroke-Sensing)	R810013LW	1	R803016	1-1/2"-10	5"	Straight	1/2"-20
R802261	Meritor Automatic Slack Adjuster Kit (Stroke-Sensing)	R810014LW	2	R803017	1-1/2"-10	5"	Straight	1/2"-20
R802280	Meritor Automatic Slack Adjuster Kit (Stroke-Sensing)	R810019	1	R803018	1-1/2"-10	5"	Straight	5/8"-18
R802281	Meritor Automatic Slack Adjuster Kit (Stroke-Sensing)	R810019	2	R803019	1-1/2"-10	5"	Straight	5/8"-18
R802300	Meritor Automatic Slack Adjuster Kit (Stroke-Sensing)	R810018	1	R803022	1-1/2"-10	5-1/2"	Straight	1/2"-20
R802301	Meritor Automatic Slack Adjuster Kit (Stroke-Sensing)	R810018	2	R803023	1-1/2"-10	5-1/2"	Straight	1/2"-20
R802292	Meritor Automatic Slack Adjuster Kit (Stroke-Sensing)	R810015LW	1	R803020	1-1/2"-10	5-1/2"	Offset	1/2"-20
R802293	Meritor Automatic Slack Adjuster Kit (Stroke-Sensing)	R810016LW	2	R803021	1-1/2"-10	5-1/2"	Offset	1/2"-20
R802290	Meritor Automatic Slack Adjuster Kit (Stroke-Sensing)	R810013LW	1	R803020	1-1/2"-10	5-1/2"	Straight	1/2"-20
R802291	Meritor Automatic Slack Adjuster Kit (Stroke-Sensing)	R810014LW	2	R803021	1-1/2"-10	5-1/2"	Straight	1/2"-20
R802310	Meritor Automatic Slack Adjuster Kit (Stroke-Sensing)	R810019	1	R803022	1-1/2"-10	5-1/2"	Straight	5/8"-18
R802311	Meritor Automatic Slack Adjuster Kit (Stroke-Sensing)	R810019	2	R803023	1-1/2"-10	5-1/2"	Straight	5/8"-18
R802320	Meritor Automatic Slack Adjuster Kit (Stroke-Sensing)	R810025	1	R803024	1-1/2"-10	5-1/2"	Offset	5/8"-18
R802321	Meritor Automatic Slack Adjuster Kit (Stroke-Sensing)	R810025	2	R803025	1-1/2"-10	5-1/2"	Offset	5/8"-18
R802316	Meritor Automatic Slack Adjuster Kit (Stroke-Sensing)	R810019	1	R803024	1-1/2"-10	5-1/2"	Straight	5/8"-18
R802317	Meritor Automatic Slack Adjuster Kit (Stroke-Sensing)	R810019	2	R803025	1-1/2"-10	5-1/2"	Straight	5/8"-18
R801041	Meritor Automatic Slack Adjuster Kit (Stroke-Sensing)	R810019	3	R803195	1-1/2"-10	5-1/2"	Straight	5/8"-18

Information & Images Provided by Meritor





MERITOR AUTOMATIC SLACK ADJUSTER REPAIR KITS



Table 1-45: Meritor Automatic Slack Adjuster (stroke sensing) Repair Kits

Product	Part Number	Description	Bracket Part Number	Angle	Straight / Offset	Spline - Size	Arm Length	Bushing Inside Diam.	Application
DRIVE AXLE APPLICATIONS - 16-1/2" AND 18" BRAKES									
	R806002	Meritor Clearance Sensing Automatic Slack Adjuster for Drive Axle Applications - 16-1/2" and 18" Brakes	R810306	0°	Straight	10 - 1-1/2"	5-1/2"	5/8"	Single Bend Control Arm. For Kenworth with 8 bag air ride to avoid interference with air bag supports. Replaces 400-10155, 409-10635
	R806003	Meritor Clearance Sensing Automatic Slack Adjuster for Drive Axle Applications - 16-1/2" and 18" Brakes	R810306	0°	Straight	28 - 1-1/2"	5-1/2"	5/8"	Single Bend Control Arm. For Kenworth with 8 bag air ride to avoid interference with air bag supports. Replaces 400-10156, 409-10648
	R806018	Meritor Clearance Sensing Automatic Slack Adjuster for Drive Axle Applications - 16-1/2" and 18" Brakes	R810302	16°	Straight	10 - 1-1/2"	6"	1/2"	Double Bend Control Arm. For Mack drive axle brakes. Replaces 400-10145, 409-10680
	R806017	Meritor Clearance Sensing Automatic Slack Adjuster for Drive Axle Applications - 16-1/2" and 18" Brakes	R810302	16°	Straight	28 - 1-1/2"	5-1/2", 6-1/2"	1/2"	Double Bend Control Arm. For Mack drive axle brakes. Replaces 400-10146, 409-10679
	R806016	Meritor Clearance Sensing Automatic Slack Adjuster for Drive Axle Applications - 16-1/2" and 18" Brakes	R810302	16°	Straight	28 - 1-1/2"	6"	1/2"	Double Bend Control Arm. For Mack drive axle brakes. Replaces 400-10144, 409-10678
	R806001	Meritor Clearance Sensing Automatic Slack Adjuster for Drive Axle Applications - 16-1/2" and 18" Brakes	R810305	16°	Straight	28 - 1-1/2"	5-1/2"	1/2"	Single Bend Control Arm. For Meritor air disc brakes. Replaces 400-10402, 409-10584






Information & Images Provided by Meritor

Product	Part Number	Description	Bracket Part Number	Angle	Straight / Offset	Spline - Size	Arm Length	Bushing Inside Diam.	Application
	R806023	Meritor Clearance Sensing Automatic Slack Adjuster for Drive Axle Applications - 16-1/2" and 18" Brakes	R810300	34°	Straight	10 - 1-1/2"	5", 6"	5/8"	Single Bend Control Arm. For standard drive axle brakes. Replaces 400-10142, 409-10741
	R806022	Meritor Clearance Sensing Automatic Slack Adjuster for Drive Axle Applications - 16-1/2" and 18" Brakes	R810300	34°	Straight	10 - 1-1/2"	5-1/2", 6-1/2"	5/8"	Single Bend Control Arm. For standard drive axle brakes. Replaces 400-10143, 409-10733
	R806024	Meritor Clearance Sensing Automatic Slack Adjuster for Drive Axle Applications - 16-1/2" and 18" Brakes	R810300	34°	Straight	28 - 1-1/2"	5", 6"	5/8"	Single Bend Control Arm. For standard drive axle brakes. Replaces 400-10140, 409-10742
	R806004	Meritor Clearance Sensing Automatic Slack Adjuster for Drive Axle Applications - 16-1/2" and 18" Brakes	R810300	34°	Straight	28 - 1-1/2"	5-1/2"	5/8"	Single Bend Control Arm. For standard drive axle brakes. Replaces 400-10141, 409-10650
	R806026	Meritor Clearance Sensing Automatic Slack Adjuster for Drive Axle Applications - 16-1/2" and 18" Brakes	R810300	34°	Straight	28 - 1-1/2"	5-1/2", 6-1/2"	5/8"	Single Bend Control Arm. For standard drive axle brakes. Replaces 400-10141, 409-10653
STEER AXLE (NON-DRIVE) APPLICATIONS - 15", 16-1/4" AND 16-1/2" BRAKES									
	R806009	Meritor Clearance Sensing Automatic Slack Adjuster for Steer Axle (non-drive) applications - 15", 16-1/4" and 16-1/2" Brakes	R810302	0°	Straight	10 - 1-1/4"	5-1/2"	5/8"	Double Bend Control Arm. For standrad steer axle brakes. Replaces 400-10001, 409-10658
	R806010	Meritor Clearance Sensing Automatic Slack Adjuster for Steer Axle (non-drive) applications - 15", 16-1/4" and 16-1/2" Brakes	R810303	0°	Straight	24 - 1-1/4"	5-1/2"	5/8"	Double Bend Control Arm. For standrad steer axle brakes. Replaces 400-10004, 409-10659
	R806011	Meritor Clearance Sensing Automatic Slack Adjuster for Steer Axle (non-drive) applications - 15", 16-1/4" and 16-1/2" Brakes	R810302	0°	Straight	10 - 1-1/2"	5-1/2"	5/8"	Double Bend Control Arm. For standrad steer axle brakes. Replaces 400-10005, 409-10662
	R806012	Meritor Clearance Sensing Automatic Slack Adjuster for Steer Axle (non-drive) applications - 15", 16-1/4" and 16-1/2" Brakes	R810302	0°	Straight	28 - 1-1/2"	5-1/2"	5/8"	Double Bend Control Arm. For standrad steer axle brakes. Replaces 400-10008, 409-10663
	R806025	Meritor Clearance Sensing Automatic Slack Adjuster for Steer Axle (non-drive) applications - 15", 16-1/4" and 16-1/2" Brakes	R810310	0°	Straight	28 - 1-1/2"	5-1/2"	1/2"	Single Bend Control Arm. For standard steer axle brakes. Replaces 400-10081, 409-10228

Information & Images Provided by Meritor

Product	Part Number	Description	Bracket Part Number	Angle	Straight / Offset	Spline - Size	Arm Length	Bushing Inside Diam.	Application
	R806502	Meritor Clearance Sensing Automatic Slack Adjuster for Steer Axle (non-drive) applications - 15", 16-1/4" and 16-1/2" Brake	R810302	22°	Offset LH - 5/8"	10 - 1-1/4"	5-1/2"	5/8"	Double Bend Control Arm. For standard steer axle brakes with 5/8" offset arm. Replaces 400-10003, 409-10660
	R806503	Meritor Clearance Sensing Automatic Slack Adjuster for Steer Axle (non-drive) applications - 15", 16-1/4" and 16-1/2" Brakes	R810302	22°	Offset RH - 5/8"	10 - 1-1/4"	5-1/2"	5/8"	Double Bend Control Arm. For standard steer axle brakes with 5/8" offset arm. Replaces 400-10002, 409-10661
	R806504	Meritor Clearance Sensing Automatic Slack Adjuster for Steer Axle (non-drive) applications - 15", 16-1/4" and 16-1/2" Brakes	R810303	22°	Offset LH - 5/8"	24 - 1-1/4"	5-1/2"	5/8"	Double Bend Control Arm. For standard steer axle brakes with 5/8" offset arm. Replaces 400-10041, 409-10664
	R806505	Meritor Clearance Sensing Automatic Slack Adjuster for Steer Axle (non-drive) applications - 15", 16-1/4" and 16-1/2" Brakes	R810303	22°	Offset RH - 5/8"	24 - 1-1/4"	5-1/2"	5/8"	Double Bend Control Arm. For standard steer axle brakes with 5/8" offset arm. Replaces 400-10040, 409-10665
	R806500	Meritor Clearance Sensing Automatic Slack Adjuster for Steer Axle (non-drive) applications - 15", 16-1/4" and 16-1/2" Brakes	R810304	22°	Offset RH - 1-1/2"	28 - 1-1/2"	5-1/2"	1/2"	Single Bend Control Arm. For Mack 16,000 lb.+ steer axle brakes with 1-1/2" offset arm. Replaces 400-10058, 409-10599
	R806501	Meritor Clearance Sensing Automatic Slack Adjuster for Steer Axle (non-drive) applications - 15", 16-1/4" and 16-1/2" Brakes	R801304	22°	Offset LH - 1-1/2"	28 - 1-1/2"	5-1/2"	1/2"	Single Bend Control Arm. For Mack 16,000 lb.+ steer axle brakes with 1-1/2" offset arm. Replaces 400-10059, 409-10600
	R806507	Meritor Clearance Sensing Automatic Slack Adjuster for Steer Axle (non-drive) applications - 15", 16-1/4" and 16-1/2" Brakes	R810311	22°	Offset LH - 5/8"	28 - 1-1/2"	6"	1/2"	Single Bend Control Arm. For Dina Bus and MCI steer axle brakes. Replaces 400-10068, 409-10638
	R806508	Meritor Clearance Sensing Automatic Slack Adjuster for Steer Axle (non-drive) applications - 15", 16-1/4" and 16-1/2" Brakes	R810314	22°	Offset RH - 5/8"	28 - 1-1/2"	6"	1/2"	Single Bend Control Arm. For Dina Bus and MCI steer axle brakes. Replaces 400-10069, 409-10639




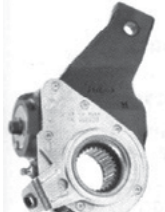


Information & Images Provided by Meritor

Product	Part Number	Description	Bracket Part Number	Angle	Straight / Offset	Spline - Size	Arm Length	Bushing Inside Diam.	Application
TRANSIT APPLICATIONS									
	R806551	Meritor Clearance Sensing Automatic Slack Adjuster for Transit Applications		0°	Straight	28 - 1-1/2"	5-1/2", 6-1/2"	6-1/4"	Single bend, 65mm. Replaces 4W9035
	R806556	Meritor Clearance Sensing Automatic Slack Adjuster for Transit Applications		0°	Straight	28 - 1-1/2"	5-1/2"	1/2"	Double bend, 69mm. Replaces 4W9075
	R806549	Meritor Clearance Sensing Automatic Slack Adjuster for Transit Applications	R810312	0°	Straight	28 - 1-1/2"	5-1/2"	1/2"	Single bend, 60mm. Includes bracket and hardware. Replaces 4W8525
	R806535	Meritor Clearance Sensing Automatic Slack Adjuster for Transit Applications	R810315	0°	Offset RH - 1-1/2"	10 - 1-1/2"	6"	1/2"	Includes bracket and hardware. Replaces 4W9055
	R806536	Meritor Clearance Sensing Automatic Slack Adjuster for Transit Applications	R810315	0°	Offset LH - 1-1/2"	10 - 1-1/2"	6"	1/2"	Includes bracket and hardware. Replaces 4W9060


Information & Images Provided by Meritor

Product	Part Number	Description	Bracket Part Number	Angle	Straight / Offset	Spline - Size	Arm Length	Bushing Inside Diam.	Application
	R806559	Meritor Clearance Sensing Automatic Slack Adjuster for Transit Applications	R810315	0°	Offset RH - 1-1/2"	28 - 1-1/2"	6"	1/2"	Includes bracket and hardware. Replaces 4W8715
	R806560	Meritor Clearance Sensing Automatic Slack Adjuster for Transit Applications	R810315	0°	Offset LH - 1-1/2"	28 - 1-1/2"	6"	1/2"	Includes bracket and hardware. Replaces 4W8720
	R806548	Meritor Clearance Sensing Automatic Slack Adjuster for Transit Applications	R810330	0°	Straight	28 - 1-1/2"	5-1/2"	5/8"	Single bend, 65mm. Includes bracket and hardware. Replaces 4W9005
	R806527	Meritor Clearance Sensing Automatic Slack Adjuster for Transit Applications	R810305	16°	Straight	10 - 1-1/2"	5-1/2"	1/2"	Single bend, 64mm. Includes bracket and hardware. Replaces 4W8535
	R806543	Meritor Clearance Sensing Automatic Slack Adjuster for Transit Applications	R810305	16°	Straight	28 - 1-1/2"	5-1/2"	1/2"	Single bend, 64mm. Includes bracket and hardware. Replaces 4W8565
	R806525	Meritor Clearance Sensing Automatic Slack Adjuster for Transit Applications	R810304	23°	Offset LH - 1-1/2"	10 - 1-1/2"	5-1/2"	1/2"	Single bend, 60mm. Includes bracket and hardware. Replaces 4W8540


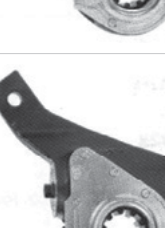
Information & Images Provided by Meritor

Product	Part Number	Description	Bracket Part Number	Angle	Straight / Offset	Spline - Size	Arm Length	Bushing Inside Diam.	Application
	R806526	Meritor Clearance Sensing Automatic Slack Adjuster for Transit Applications	R810304	23°	Offset LH - 1-1/2"	10 - 1-1/2"	5-1/2"	1/2"	Single bend, 60mm. Includes bracket and hardware. Replaces 4W8545
	R806532	Meritor Clearance Sensing Automatic Slack Adjuster for Transit Applications	R810312	23°	Offset LH - 5/8"	28 - 1-1/2"	5-1/2"	1/2"	Single bend, 60mm. Includes bracket and hardware. Replaces 4W8510
	R806533	Meritor Clearance Sensing Automatic Slack Adjuster for Transit Applications	R810312	23°	Offset RH - 5/8"	28 - 1-1/2"	5-1/2"	1/2"	Single bend, 60mm. Includes bracket and hardware. Replaces 4W8515
	R806528	Meritor Clearance Sensing Automatic Slack Adjuster for Transit Applications	R810328	23°	Offset LH - 5/8"	28 - 1-1/2"	5-1/2"	1/2"	Single bend, 60mm. Includes bracket and hardware. Replaces 4W8620
	R806529	Meritor Clearance Sensing Automatic Slack Adjuster for Transit Applications	R810328	23°	Offset RH - 5/8"	28 - 1-1/2"	5-1/2"	1/2"	Single bend, 60mm. Includes bracket and hardware. Replaces 4W8635
	R806537	Meritor Clearance Sensing Automatic Slack Adjuster for Transit Applications	n/a	28°	Offset RH - 1-9/16"	26 - 1-1/2"	5-1/8"	1/2"	Double bend, 66mm. Replaces 4W3265

Information & Images Provided by Meritor

Product	Part Number	Description	Bracket Part Number	Angle	Straight / Offset	Spline - Size	Arm Length	Bushing Inside Diam.	Application
	R806538	Meritor Clearance Sensing Automatic Slack Adjuster for Transit Applications	n/a	28°	Offset LH - 1-9/16"	26 - 1-1/2"	5-1/8"	1/2"	Double bend, 66mm. Replaces 4W3270
	R806545	Meritor Clearance Sensing Automatic Slack Adjuster for Transit Applications	n/a	34°	Offset RH - 1-1/2"	10 - 1-1/2"	5-1/2"	1/2"	Single bend, 60mm. Replaces 4W8560
	R806541	Meritor Clearance Sensing Automatic Slack Adjuster for Transit Applications	n/a	34°	Offset LH - 1-1/2"	10 - 1-1/2"	6"	1/2"	Single bend, 64mm. Replaces 4W8640
	R806544	Meritor Clearance Sensing Automatic Slack Adjuster for Transit Applications	n/a	34°	Offset LH - 1-1/2"	10 - 1-1/2"	6"	1/2"	Replaces 4W9030
	R806552	Meritor Clearance Sensing Automatic Slack Adjuster for Transit Applications	n/a	34°	Straight	10 - 1-1/2"	6"	1/2"	Single bend, 64mm. Replaces 4W9040
	R806554	Meritor Clearance Sensing Automatic Slack Adjuster for Transit Applications	n/a	34°	Offset LH - 1-1/2"	10 - 1-1/2"	7"	1/2"	Double bend, 69mm. Replaces 4W8590

Information & Images Provided by Meritor

Product	Part Number	Description	Bracket Part Number	Angle	Straight / Offset	Spline - Size	Arm Length	Bushing Inside Diam.	Application
	R806555	Meritor Clearance Sensing Automatic Slack Adjuster for Transit Applications	n/a	34°	Offset RH - 1-1/2"	10 - 1-1/2"	7"	1/2"	Double bend, 69mm. Replaces 4W8680
	R806547	Meritor Clearance Sensing Automatic Slack Adjuster for Transit Applications	R810300	34°	Straight	28 - 1-1/2"	6"	1/2"	Includes bracket and hardware. Replaces 4W9015
	R806521	Meritor Clearance Sensing Automatic Slack Adjuster for Transit Applications	R810309	34°	Offset LH - 1-1/2"	10 - 1-1/2"	7"	1/2"	Single bend, 64mm. Includes bracket and hardware. Replaces 4W8500
	R806523	Meritor Clearance Sensing Automatic Slack Adjuster for Transit Applications	R810309	34°	Straight	10 - 1-1/2"	7"	1/2"	Single bend, 64mm. Includes bracket and hardware. Replaces 4W8645
	R806534	Meritor Clearance Sensing Automatic Slack Adjuster for Transit Applications	R810312	34°	Straight	28 - 1-1/2"	6-1/2"	1/2"	Single bend, 60mm. Includes bracket and hardware. Replaces 4W8520
	R806530	Meritor Clearance Sensing Automatic Slack Adjuster for Transit Applications	R810315	34°	Offset LH - 1-1/2"	10 - 1-1/2"	6"	1/2"	Single bend, 64mm. Includes bracket and hardware. Replaces 4W8600




Information & Images Provided by Meritor

Product	Part Number	Description	Bracket Part Number	Angle	Straight / Offset	Spline - Size	Arm Length	Bushing Inside Diam.	Application
	R806531	Meritor Clearance Sensing Automatic Slack Adjuster for Transit Applications	R810315	34°	Offset RH - 1-1/2"	10 - 1-1/2"	6"	1/2"	Single bend, 64mm. Includes bracket and hardware. Replaces 4W8570
	R806539	Meritor Clearance Sensing Automatic Slack Adjuster for Transit Applications	R810316	34°	Offset LH - 1-1/2"	10 - 1-1/2"	7"	1/2"	Single bend, 60mm. Includes bracket and hardware. Replaces 4W8615
	R806540	Meritor Clearance Sensing Automatic Slack Adjuster for Transit Applications	R810316	34°	Offset RH - 1-1/2"	10 - 1-1/2"	7"	1/2"	Single bend, 60mm. Includes bracket and hardware. Replaces 4W8630
	R806542	Meritor Clearance Sensing Automatic Slack Adjuster for Transit Applications	R810328	34°	Offset RH - 1-1/2"	10 - 1-1/2"	6"	1/2"	Single bend, 64mm. Includes bracket and hardware. Replaces 4W8605
	R806546	Meritor Clearance Sensing Automatic Slack Adjuster for Transit Applications	R810328	34°	Offset LH - 1-1/2"	28 - 1-1/2"	5-1/2"	1/2"	Includes bracket and hardware. Replaces 4W9010

Information & Images Provided by Meritor

Product	Part Number	Description	Bracket Part Number	Angle	Straight / Offset	Spline - Size	Arm Length	Bushing Inside Diam.	Application
	R806550	Meritor Clearance Sensing Automatic Slack Adjuster for Transit Applications	R810329	34°	Straight	28 - 1-1/2"	6-1/2"	1/2"	Single bend, 64mm. Includes bracket and hardware. Replaces 4W8690
	R806553	Meritor Clearance Sensing Automatic Slack Adjuster for Transit Applications	R810331	34°	Straight	10 - 1-1/2"	5-1/2"	5/8"	Includes bracket and hardware. Replaces 4W9050
	R806557	Meritor Clearance Sensing Automatic Slack Adjuster for Transit Applications	R810333	34°	Offset LH - 1-1/2"	10 - 1-1/2"	6"	1/2"	Single bend, 65mm. Includes bracket and hardware. Replaces 4W8625
	R806558	Meritor Clearance Sensing Automatic Slack Adjuster for Transit Applications	R810333	34°	Offset RH - 1-1/2"	10 - 1-1/2"	6"	1/2"	Single bend, 65mm. Includes bracket and hardware. Replaces 4W8595
	R806522	Meritor Clearance Sensing Automatic Slack Adjuster for Transit Applications	R810336	34°	Offset RH - 1-1/2"	10 - 1-1/2"	7"	1/2"	Single bend, 64mm. Includes bracket and hardware. Replaces 4W8650

Information & Images Provided by Meritor

Product	Part Number	Description	Bracket Part Number	Angle	Straight / Offset	Spline - Size	Arm Length	Bushing Inside Diam.	Application
	R806524	Meritor Clearance Sensing Automatic Slack Adjuster for Transit Applications	R810336	34°	Straight	10 - 1-1/2"	7"	1/2"	Single bend, 64mm. Includes bracket and hardware. Replaces 4W8610
	R806563	Meritor Clearance Sensing Automatic Slack Adjuster for Transit Applications	n/a	120°	Offset RH - 5/8"	26 - 1-1/2"	5-1/8"	1/2"	Double bend, 65mm. Replaces 4W3115
	R806564	Meritor Clearance Sensing Automatic Slack Adjuster for Transit Applications	n/a	120°	Offset LH - 5/8"	26 - 1-1/2"	5-1/8"	1/2"	Double bend, 65mm. Replaces 4W3120

Information & Images Provided by Meritor

CROSS REFERENCE

BRAKE SLACK ADJUSTERS CROSS REFERENCE

Table 1-46: Brake Slack Adjusters Cross Reference

Manufacturer	OE Part Number	Part Number
ROCKWELL		
Rockwell	A23275H1152S	R801001
Rockwell	A43275N768S	R801001
Rockwell	A163275N768S	R801002
Rockwell	A93275H1152S	R801002
Rockwell	A123275H1152S	R801003
Rockwell	A253275N768S	R801003
Rockwell	A273275N768S	R801004
Rockwell	A53275H1152S	R801004
Rockwell	A13275J1154S	R801040
Rockwell	A143275N716S	R801040
Rockwell	A23275J1154S	R801040
Rockwell	A93275N716S	R801040
Rockwell	A153275H1152S	R801041
Rockwell	A163275H1152S	R801041
Rockwell	A223275N768S	R801041
Rockwell	A263275N768S	R801041
Rockwell	A133275N716S	R801042
Rockwell	A33275J1154S	R801042
Rockwell	A43275J1154S	R801042
Rockwell	A83275N716S	R801042
Rockwell	A13275N768S	R801043
Rockwell	A183275H1152S	R801043
Rockwell	A193275H1152S	R801043
Rockwell	A73275N768S	R801043
Rockwell	A13275N716S	R801044
Rockwell	A63275J1154S	R801044
Rockwell	A13275P718S	R801045
Rockwell	A33275P718S	R801048
Rockwell	A133275N768S	R801070
Rockwell	A223275H1152S	R801070

Rockwell	A103275J1154S	R801071
Rockwell	A113275N716S	R801071
Rockwell	A163275N716S	R801071
Rockwell	A93275J1154S	R801071
Rockwell	A23275N768S	R801072
Rockwell	A343275H1152S	R801072
Rockwell	A353275H1152S	R801072
Rockwell	A83275N768S	R801072
Rockwell	A213275N768S	R801073
Rockwell	A243275N768S	R801073
Rockwell	A273275H1152S	R801073
Rockwell	A283275H1152S	R801073
Rockwell	A103275N716S	R801074
Rockwell	A133275J1154S	R801074
Rockwell	A143275J1154S	R801074
Rockwell	A153275N716S	R801074
Rockwell	A163275J1154S	R801075
Rockwell	A173275J1154S	R801075
Rockwell	A23275N716S	R801075
Rockwell	A53275N716S	R801075
Rockwell	A23275G1151S	R801077
Rockwell	A33275B1042S	R801077
Rockwell	A233275H1152S	R801079
Rockwell	A333275N768S	R801079
Rockwell	A233275N768S	R801080
Rockwell	A233275N768S	R801080
Rockwell	A333275H1152S	R801080
Rockwell	A183275N716S	R801100
Rockwell	A193275J1154S	R801100
Rockwell	A203275N768S	R801101
Rockwell	A313275H1152S	R801101
Rockwell	A123275N716S	R801102
Rockwell	A173275N716S	R801102
Rockwell	A203275J1154S	R801102
Rockwell	A213275J1154S	R801102
Rockwell	A13275X1142S	R802000
Rockwell	A63275T592S	R802000
Rockwell	A13275Y1143S	R802001
Rockwell	A63275Z598S	R802001

Brake Slack Adjusters Cross Reference

1

Rockwell	A23275X1142S	R802002
Rockwell	A73275T592S	R802002
Rockwell	A23275Y1143S	R802003
Rockwell	A73275Z598S	R802003
Rockwell	A13275Z1144S	R802020
Rockwell	A83275U593S	R802020
Rockwell	A13275A1145S	R802021
Rockwell	A73275A599S	R802021
Rockwell	A23275Z1144S	R802022
Rockwell	A93275U593S	R802022
Rockwell	A23275A1145S	R802023
Rockwell	A83275A599S	R802023
Rockwell	A153275U593S	R802030
Rockwell	A53275Z1144S	R802030
Rockwell	A143275A599S	R802031
Rockwell	A53275A1145S	R802031
Rockwell	A123275U593S	R802032
Rockwell	A43275Z1144S	R802032
Rockwell	A113275A599S	R802033
Rockwell	A43275A1145S	R802033
Rockwell	A473275U593S	R802040
Rockwell	A83275Z1144S	R802040
Rockwell	A473275A599S	R802041
Rockwell	A83275A1145S	R802041
Rockwell	A463275U593S	R802042
Rockwell	A73275Z1144S	R802042
Rockwell	A463275A599S	R802043
Rockwell	A73275A1145S	R802043
Rockwell	A13275E1201S	R802048
Rockwell	A43275T1060S	R802048
Rockwell	A13275F1202S	R802049
Rockwell	A43275U1061S	R802049
Rockwell	A413275U593S	R802050
Rockwell	A93275Z1144S	R802050
Rockwell	A413275A599S	R802051
Rockwell	A93275A1145S	R802051
Rockwell	A103275Z1144S	R802052
Rockwell	A553275U593S	R802052
Rockwell	A103275A1145S	R802053

Rockwell	A553275A599S	R802053
Rockwell	A133275Z1144S	R802060
Rockwell	A403275U593S	R802060
Rockwell	A133275A1145S	R802061
Rockwell	A403275A599S	R802061
Rockwell	A123275Z1144S	R802062
Rockwell	A383275U593S	R802062
Rockwell	A123275A1145S	R802063
Rockwell	A383275A599S	R802063
Rockwell	A153275Z1144S	R802070
Rockwell	A523275U593S	R802070
Rockwell	A153275A1145S	R802071
Rockwell	A523275A599S	R802071
Rockwell	A163275Z1144S	R802072
Rockwell	A533275U593S	R802072
Rockwell	A163275A1145S	R802073
Rockwell	A533275A599S	R802073
Rockwell	A183275Z1144S	R802074
Rockwell	A513275U593S	R802074
Rockwell	A183275A1145S	R802075
Rockwell	A513275A599S	R802075
Rockwell	A53275X1142S	R802260
Rockwell	A83275T592S	R802260
Rockwell	A53275Y1143S	R802261
Rockwell	A83275Z598S	R802261
Rockwell	A63275X1142S	R802262
Rockwell	A93275T592S	R802262
Rockwell	A63275Y1143S	R802263
Rockwell	A93275Z598S	R802263
Rockwell	A13275T592S	R802280
Rockwell	A93275X1142S	R802280
Rockwell	A13275Z598S	R802281
Rockwell	A93275Y1143S	R802281
Rockwell	A103275U593S	R802290
Rockwell	A193275Z1144S	R802290
Rockwell	A193275A1145S	R802291
Rockwell	A93275A599S	R802291
Rockwell	A113275U593S	R802292
Rockwell	A203275Z1144S	R802292

1

Brake Slack Adjusters Cross Reference

Rockwell	A103275A599S	R802293
Rockwell	A203275A1145S	R802293
Rockwell	A213275Z1144S	R802300
Rockwell	A73275U593S	R802300
Rockwell	A213275A1145S	R802301
Rockwell	A63275A599S	R802301
Rockwell	A233275Z1144S	R802310
Rockwell	A433275U593S	R802310
Rockwell	A233275A1145S	R802311
Rockwell	A433275A599S	R802311
Rockwell	A253275Z1144S	R802316
Rockwell	A423275U593S	R802316
Rockwell	A253275A1145S	R802317
Rockwell	A423275A599S	R802317
Rockwell	A263275Z1144S	R802320
Rockwell	A493275U593S	R802320
Rockwell	A263275A1145S	R802321
Rockwell	A13275U593S	R802332
Rockwell	A293275Z1144S	R802332
Rockwell	A13275A599S	R802333
Rockwell	A293275A1145S	R802333
Rockwell	A143275V594S	R802354
Rockwell	A33275B1146S	R802354
Rockwell	A143275B600S	R802355
Rockwell	A33275C1147S	R802355
Rockwell	A13275V594S	R802356
Rockwell	A63275B1146S	R802356
Rockwell	A13275B600S	R802357
Rockwell	A63275C1147S	R802357
Rockwell	A113275C601S	R802361
Rockwell	A13275E1149S	R802361
Rockwell	A13275C601S	R802371
Rockwell	A33275E1149S	R802371
Rockwell	A13275N1158S	R802380
Rockwell	A13275Y701S	R802380
Rockwell	A13275P1160S	R802381
Rockwell	A13275Z702S	R802381
Rockwell	A23275N1158S	R802382
Rockwell	A33275Y701S	R802382

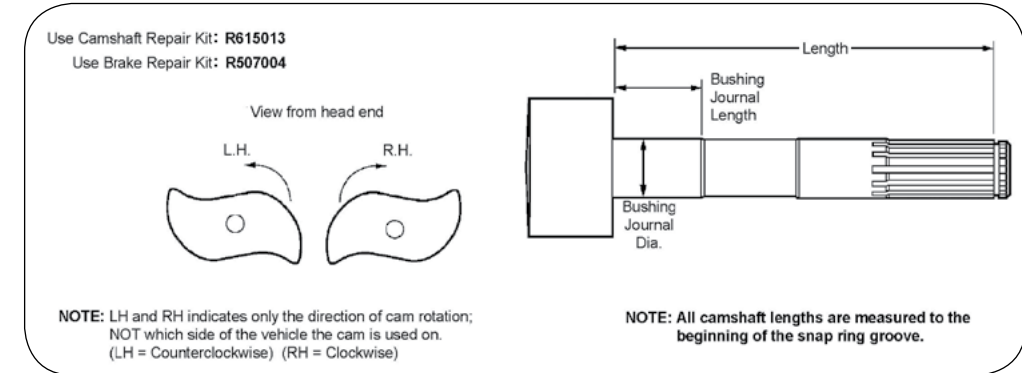
Rockwell	A23275P1160S	R802383
Rockwell	A33275Z702S	R802383
Rockwell	A103275T592S	R802400
Rockwell	A103275X1142S	R802400
Rockwell	A103275Y1143S	R802401
Rockwell	A103275Z598S	R802401
Rockwell	A113275X1142S	R802402
Rockwell	A123275T592S	R802402
Rockwell	A113275Y1143S	R802403
Rockwell	A123275Z598S	R802403
Rockwell	A13275S1085S	R802412
Rockwell	A33275U1191S	R802412
Rockwell	A13275T1086S	R802413
Rockwell	A33275V1192S	R802413
Rockwell	A133275X1142S	R802414
Rockwell	A263275T592S	R802414
Rockwell	A133275Y1143S	R802415
Rockwell	A263275Z598S	R802415
Rockwell	A173275X1142S	R802416
Rockwell	A23275T592S	R802416
Rockwell	A173275Y1143S	R802417
Rockwell	A23275Z598S	R802417
Rockwell	A173275U593S	R802420
Rockwell	A303275Z1144S	R802420
Rockwell	A163275A599S	R802421
Rockwell	A303275A1145S	R802421
Rockwell	A213275U593S	R802422
Rockwell	A313275Z1144S	R802422
Rockwell	A213275A599S	R802423
Rockwell	A313275A1145S	R802423
Rockwell	A183275U593S	R802430
Rockwell	A323275Z1144S	R802430
Rockwell	A173275A599S	R802431
Rockwell	A323275A1145S	R802431
Rockwell	A363275Z1144S	R802440
Rockwell	A443275U593S	R802440
Rockwell	A363275A1145S	R802441
Rockwell	A443275A599S	R802441
Rockwell	A23275U593S	R802444

Rockwell	A463275Z1144S	R802444
Rockwell	A23275A599S	R802445
Rockwell	A463275A1145S	R802445
Rockwell	A393275Z1144S	R802446
Rockwell	A563275U593S	R802446
Rockwell	A393275A1145S	R802447
Rockwell	A563275A599S	R802447
Rockwell	A293275A599S	R802462
Rockwell	A433275A1145S	R802462
Rockwell	A293275U593S	R802463
Rockwell	A433275Z1144S	R802463
Rockwell	A133275B1146S	R802486
Rockwell	A163275V594S	R802486
Rockwell	A133275C1147S	R802487
Rockwell	A163275B600S	R802487
Rockwell	A163275B1146S	R802490
Rockwell	A23275V594S	R802490
Rockwell	A163275C1147S	R802491
Rockwell	A23275B600S	R802491
Rockwell	A73275D1148S	R802512
Rockwell	A23275C601S	R802513
Rockwell	A73275E1149S	R802513
Rockwell	A453275A599S	R802610
Rockwell	A483275A1145S	R802610
Rockwell	A453275U593S	R802611
Rockwell	A483275Z1144S	R802611
Rockwell	A173275B1146S	R802616
Rockwell	A213275V594S	R802616
Rockwell	A173275C1147S	R802617
Rockwell	A213275B600S	R802617
Rockwell	A183275B600S	R802620
Rockwell	A183275C1147S	R802620
Rockwell	A183275B1146S	R802621
Rockwell	A183275V594S	R802621
Rockwell	A133275C601S	R802630
Rockwell	A93275E1149S	R802630
Rockwell	A133275W595S	R802631
Rockwell	A93275D1148S	R802631
Rockwell	A123275E1045S	R802644

Rockwell	A133275W1193S	R802644
Rockwell	A123275F1046S	R802645
Rockwell	A133275X1194S	R802645
Rockwell	A153275W1193S	R802648
Rockwell	A93275E1045S	R802648
Rockwell	A153275X1194S	R802649
Rockwell	A93275F1046S	R802649
Rockwell	A53275E1201S	R802656
Rockwell	A53275F1202S	R802657
Rockwell	A63275U1061S	R802657
Rockwell	A13275E1045S	R802666
Rockwell	A143275W1193S	R802666
Rockwell	A13275F1046S	R802667
Rockwell	A143275X1194S	R802667
Rockwell	A23275T1216S	R802684
Rockwell	A23275U1217S	R802685

BRAKE S-CAMS

Use Camshaft repair kit: R615013



10 SPLINE / 1-1/4" DIAMETER

- Use Brake repair kit: R507004

Table 1-47: Eaton Steering Axles with 15" single anchor pin brakes

Part Number	Description	Head End	Effective Length	Bushing Journal Length	Bushing Journal Diameter
R607127	S-Cam - 1-1/4" -10 spline for Eaton Steering Axles with 15" single anchor pin brakes	LH	7-21/32"	1-7/8"	1-1/4"
R607128	S-Cam - 1-1/4" -10 spline for Eaton Steering Axles with 15" single anchor pin brakes	RH	7-21/32"	1-7/8"	1-1/4"
R607129	S-Cam - 1-1/4" -10 spline for Eaton Steering Axles with 15" single anchor pin brakes	LH	7-15/16"	1-7/8"	1-1/4"
R607130	S-Cam - 1-1/4" -10 spline for Eaton Steering Axles with 15" single anchor pin brakes	RH	7-15/16"	1-7/8"	1-1/4"
R607141	S-Cam - 1-1/4" -10 spline for Eaton Steering Axles with 15" single anchor pin brakes	LH	8-3/16"	1-7/8"	1-1/4"
R607142	S-Cam - 1-1/4" -10 spline for Eaton Steering Axles with 15" single anchor pin brakes	RH	8-3/16"	1-7/8"	1-1/4"
R607133	S-Cam - 1-1/4" -10 spline for Eaton Steering Axles with 15" single anchor pin brakes	LH	8-9/16"	1-7/8"	1-1/4"
R607134	S-Cam - 1-1/4" -10 spline for Eaton Steering Axles with 15" single anchor pin brakes	RH	8-9/16"	1-7/8"	1-1/4"
R607143	S-Cam - 1-1/4" -10 spline for Eaton Steering Axles with 15" single anchor pin brakes	LH	8-15/16"	1-7/8"	1-1/4"
R607144	S-Cam - 1-1/4" -10 spline for Eaton Steering Axles with 15" single anchor pin brakes	RH	8-15/16"	1-7/8"	1-1/4"
R607137	S-Cam - 1-1/4" -10 spline for Eaton Steering Axles with 15" single anchor pin brakes	LH	9-3/16"	1-7/8"	1-1/4"
R607138	S-Cam - 1-1/4" -10 spline for Eaton Steering Axles with 15" single anchor pin brakes	RH	9-3/16"	1-7/8"	1-1/4"
R607131	S-Cam - 1-1/4" -10 spline for Eaton Steering Axles with 15" single anchor pin brakes	LH	9-9/16"	1-7/8"	1-1/4"
R607132	S-Cam - 1-1/4" -10 spline for Eaton Steering Axles with 15" single anchor pin brakes	RH	9-9/16"	1-7/8"	1-1/4"
R607139	S-Cam - 1-1/4" -10 spline for Eaton Steering Axles with 15" single anchor pin brakes	LH	9-25/32"	1-7/8"	1-1/4"
R607140	S-Cam - 1-1/4" -10 spline for Eaton Steering Axles with 15" single anchor pin brakes	RH	9-25/32"	1-7/8"	1-1/4"
R607135	S-Cam - 1-1/4" -10 spline for Eaton Steering Axles with 15" single anchor pin brakes	LH	10-29/32"	1-7/8"	1-1/4"
R607136	S-Cam - 1-1/4" -10 spline for Eaton Steering Axles with 15" single anchor pin brakes	RH	10-29/32"	1-7/8"	1-1/4"

Information & Images Provided by Meritor

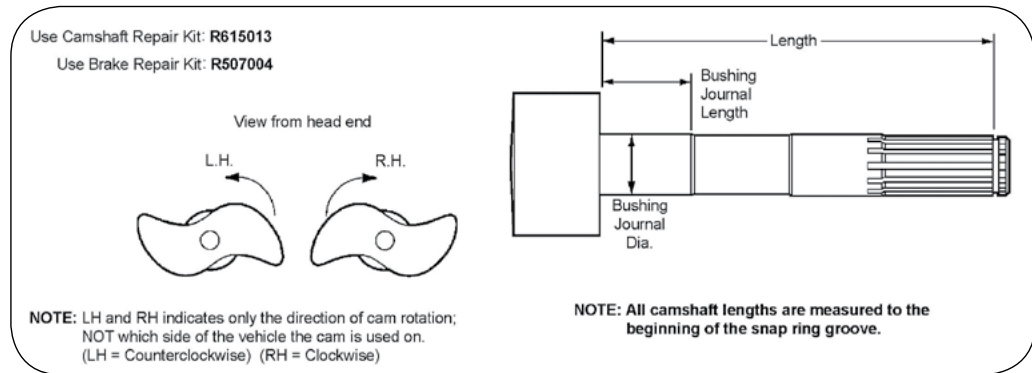


Table 1-48: Eaton Steering Axles with 15" ES (Extended Service) Brakes

Part Number	Description	Head End	Effective Length	Bushing Journal Length	Bushing Journal Diameter
R607121	S-Cam - 1-1/4" -10 spline for Eaton Steering Axles with 15" ES (Extended Service) Brakes	LH	7-15/16"	1-7/8"	1-1/4"
R607122	S-Cam - 1-1/4" -10 spline for Eaton Steering Axles with 15" ES (Extended Service) Brakes	RH	7-15/16"	1-7/8"	1-1/4"
R607117	S-Cam - 1-1/4" -10 spline for Eaton Steering Axles with 15" ES (Extended Service) Brakes	LH	9-3/16"	1-7/8"	1-1/4"
R607118	S-Cam - 1-1/4" -10 spline for Eaton Steering Axles with 15" ES (Extended Service) Brakes	RH	9-3/16"	1-7/8"	1-1/4"
R607119	S-Cam - 1-1/4" -10 spline for Eaton Steering Axles with 15" ES (Extended Service) Brakes	LH	9-9/16"	1-7/8"	1-1/4"
R607120	S-Cam - 1-1/4" -10 spline for Eaton Steering Axles with 15" ES (Extended Service) Brakes	RH	9-9/16"	1-7/8"	1-1/4"
R607123	S-Cam - 1-1/4" -10 spline for Eaton Steering Axles with 15" ES (Extended Service) Brakes	LH	9-25/32"	1-7/8"	1-1/4"
R607124	S-Cam - 1-1/4" -10 spline for Eaton Steering Axles with 15" ES (Extended Service) Brakes	RH	9-25/32"	1-7/8"	1-1/4"

MERITOR S-CAM REPAIR KITS



Table 1-49: Bronze Bushing S-Cam Repair Kit for Bus Brakes

Part Number	Description	Quantity	Application Information
Bronze bushing repair kit for Bus brakes – K1T8032 - Meritor S-Camshaft repair kit using a bronze bushing for bus brakes			
1225R512	Camshaft Bushing	2	Bronze bushing for bus brakes
A1205V1556	Camshaft Seal	2	Bronze bushing for bus brakes

Information & Images Provided by Meritor



Table 1-50: Eaton 15" S-Cam Brake Repair Kits

Part Number	Description	Item	Quantity	Application Information
EATON 15" BRAKES – R615013 - Meritor S-Camshaft repair kit for Eaton 15"				
R627029	Camshaft Bushing	1	4	Front steering axle. For Eaton single anchor pin style. Services 2 brakes.
R627030	Camshaft Seal	2	4	Front steering axle. For Eaton single anchor pin style. Services 2 brakes.
R627031	Washer	3	2	Front steering axle. For Eaton single anchor pin style. Services 2 brakes.
R627032	Washer	4	2	Front steering axle. For Eaton single anchor pin style. Services 2 brakes.
R627012	Cam Lock Ring	5	2	Front steering axle. For Eaton single anchor pin style. Services 2 brakes.

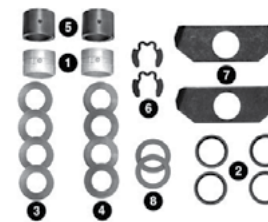


Table 1-51: Eaton 15" and 16-1/2" S-Cam Brake Repair Kits

Part Number	Description	Item	Qty.	Application Information
EATON 15" AND 16-1/2" BRAKES – R615021 - Meritor S-Camshaft repair kit R615021 for Eaton 15" and 16-1/2"				
1225L1208	Nylon Bushing	1	2	For Eaton 15" Reduced Envelope brakes and drive axles with "ES" Extended Service brakes. Services 2 brakes.
R627018	Camshaft Seal	2	4	For Eaton 15" Reduced Envelope brakes and drive axles with "ES" Extended Service brakes. Services 2 brakes.
R627006	Washer	3	4	For Eaton 15" Reduced Envelope brakes and drive axles with "ES" Extended Service brakes. Services 2 brakes.
R627005	Washer	4	4	For Eaton 15" Reduced Envelope brakes and drive axles with "ES" Extended Service brakes. Services 2 brakes.
R657005	Cam Bushing	5	2	For Eaton 15" Reduced Envelope brakes and drive axles with "ES" Extended Service brakes. Services 2 brakes.
R627012	Cam Lock Ring	6	2	For Eaton 15" Reduced Envelope brakes and drive axles with "ES" Extended Service brakes. Services 2 brakes.
R627033	Washer	7	2	For Eaton 15" Reduced Envelope brakes and drive axles with "ES" Extended Service brakes. Services 2 brakes.
1229R122	Spacer Washer	8	2	For Eaton 15" Reduced Envelope brakes and drive axles with "ES" Extended Service brakes. Services 2 brakes.

Information & Images Provided by Meritor



Table 1-52: Eaton 15", 16-1/2" and 18" S-Cam Brake Repair Kits

Part Number	Description	Item	Quantity	Application Information
EATON 15", 16-1/2" AND 18" – R615002 - BRAKES Meritor S-Camshaft repair kit R615002 for Eaton 15" and 16-1/2" and 18"				
1225L1208	Nylon Bushing	1	4	Drive axle. New style fabricated cam brackets. Services 2 brakes.
R627005	Washer	2	2	Drive axle. New style fabricated cam brackets. Services 2 brakes.
R627006	Washer	3	4	Drive axle. New style fabricated cam brackets. Services 2 brakes.
R627012	Cam Lock Ring	4	2	Drive axle. New style fabricated cam brackets. Services 2 brakes.
R627008	Camshaft Seal	5	4	Drive axle. New style fabricated cam brackets. Services 2 brakes.

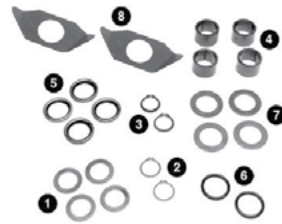


Table 1-53: Meritor 15" and 16-1/2" - Q and Q Plus S-Cam Brake Repair Kits

Part Number	Description	Item	Quantity	Application Information
MERITOR 15" AND 16-1/2" - Q AND Q PLUS – K1T8042 - BRAKES Meritor S-Camshaft repair kit 8042 for Meritor 15" and 16-1/2" Q and Q Plus				
1229G2971	Washer	1	4	Drive axle with 1-1/2" x 28" spline camshaft. Services 2 brakes.
1229X1116	Snap Ring	2	2	Drive axle with 1-1/2" x 28" spline camshaft. Services 2 brakes.
1229D2942	Snap Ring	3	2	Drive axle with 1-1/2" x 28" spline camshaft. Services 2 brakes.
1225L1208	Nylon Bushing	4	4	Drive axle with 1-1/2" x 28" spline camshaft. Services 2 brakes.
A1205V1556	Seal	5	4	Drive axle with 1-1/2" x 28" spline camshaft. Services 2 brakes.
1205G761	O-Ring	6	2	Drive axle with 1-1/2" x 28" spline camshaft. Services 2 brakes.
1229S2697	Washer	7	4	Drive axle with 1-1/2" x 28" spline camshaft. Services 2 brakes.
1229E4685	Washer	8	2	Drive axle with 1-1/2" x 28" spline camshaft. Services 2 brakes.

Information & Images Provided by Meritor



Table 1-54: Meritor 16-1/2" - P, Q, Q Plus S-Cam Brake Repair Kits

Part Number	Description	Item	Quantity	Application Information
MERITOR 16-1/2" - P, Q, Q PLUS BRAKES – K1T8033 - Meritor S-Camshaft repair kit 8033 for Meritor 16-1/2" P, Q, Q Plus				
1225L1208	Nylon Bushing	1	2	Nylon bushing and seal kit for all 16-1/2" P and Q brakes. Services 1 brake.
A1205V1556	Seal	2	2	Nylon bushing and seal kit for all 16-1/2" P and Q brakes. Services 1 brake.

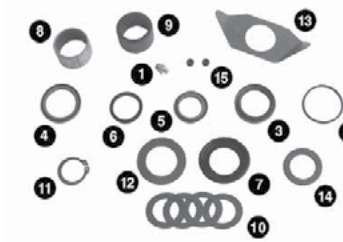
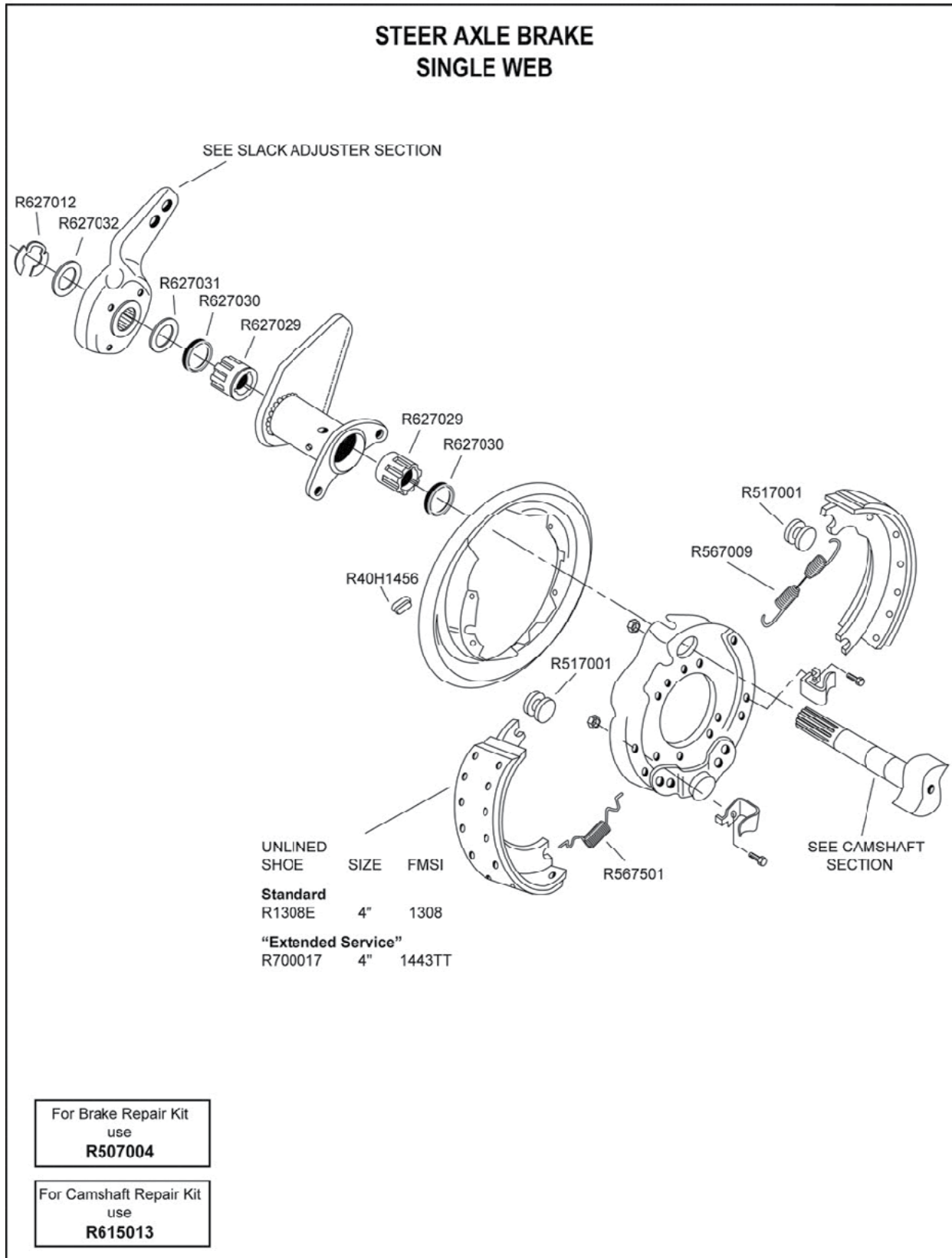


Table 1-55: Meritor 16-1/2" Q Plus Long Life (LX500) S-Cam Brake Repair Kits

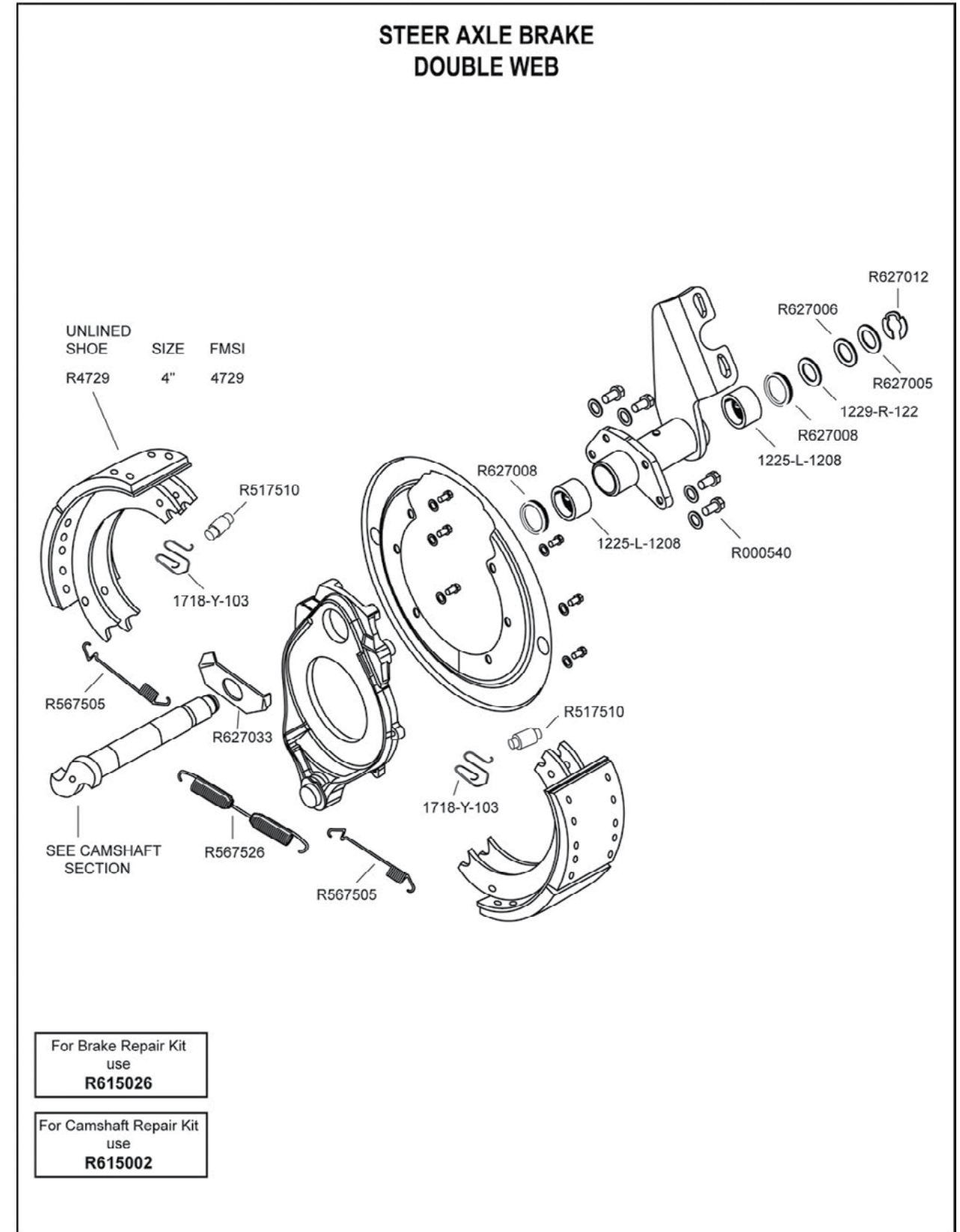
Part Number	Description	Item	Quantity	Application Information
MERITOR 16-1/2" Q PLUS LONG LIFE BRAKES (LX500) - K1T8883 - Meritor S-Camshaft repair kit - 16-1/2" Q Plus Long Life (LX500) brakes, for cast and stamped spiders				
199N1860	Lube Fitting	1	1	16.5" Q Plus Long Life brakes (LX500), for cast and stamped spiders
1205E2527	Seal	5	1	16.5" Q Plus Long Life brakes (LX500), for cast and stamped spiders
1205F25828	Seal	6	1	16.5" Q Plus Long Life brakes (LX500), for cast and stamped spiders
1205G761	O-Ring	2	1	16.5" Q Plus Long Life brakes (LX500), for cast and stamped spiders
1205Z2652	Seal	7	1	16.5" Q Plus Long Life brakes (LX500), for cast and stamped spiders
1225C1277	Camshaft Bushing	9	1	16.5" Q Plus Long Life brakes (LX500), for cast and stamped spiders
1225J1362	Camshaft Bushing	8	1	16.5" Q Plus Long Life brakes (LX500), for cast and stamped spiders
1229D2942	Snap Ring	11	1	16.5" Q Plus Long Life brakes (LX500), for cast and stamped spiders
1229F4686	Special Washer	13	1	16.5" Q Plus Long Life brakes (LX500), for cast and stamped spiders
1229H4090	Flat Washer	12	1	16.5" Q Plus Long Life brakes (LX500), for cast and stamped spiders
1229J3130	Washer	10	4	16.5" Q Plus Long Life brakes (LX500), for cast and stamped spiders
1229W3117	Washer	14	1	16.5" Q Plus Long Life brakes (LX500), for cast and stamped spiders
1250J1284	Plug	15	2	16.5" Q Plus Long Life brakes (LX500), for cast and stamped spiders
2297X7304	Grease (14 oz.) - not shown	16	1	16.5" Q Plus Long Life brakes (LX500), for cast and stamped spiders
A1205K2533	Grease Seal	4	1	16.5" Q Plus Long Life brakes (LX500), for cast and stamped spiders
A1250V1556	Seal	3	1	16.5" Q Plus Long Life brakes (LX500), for cast and stamped spiders

Information & Images Provided by Meritor

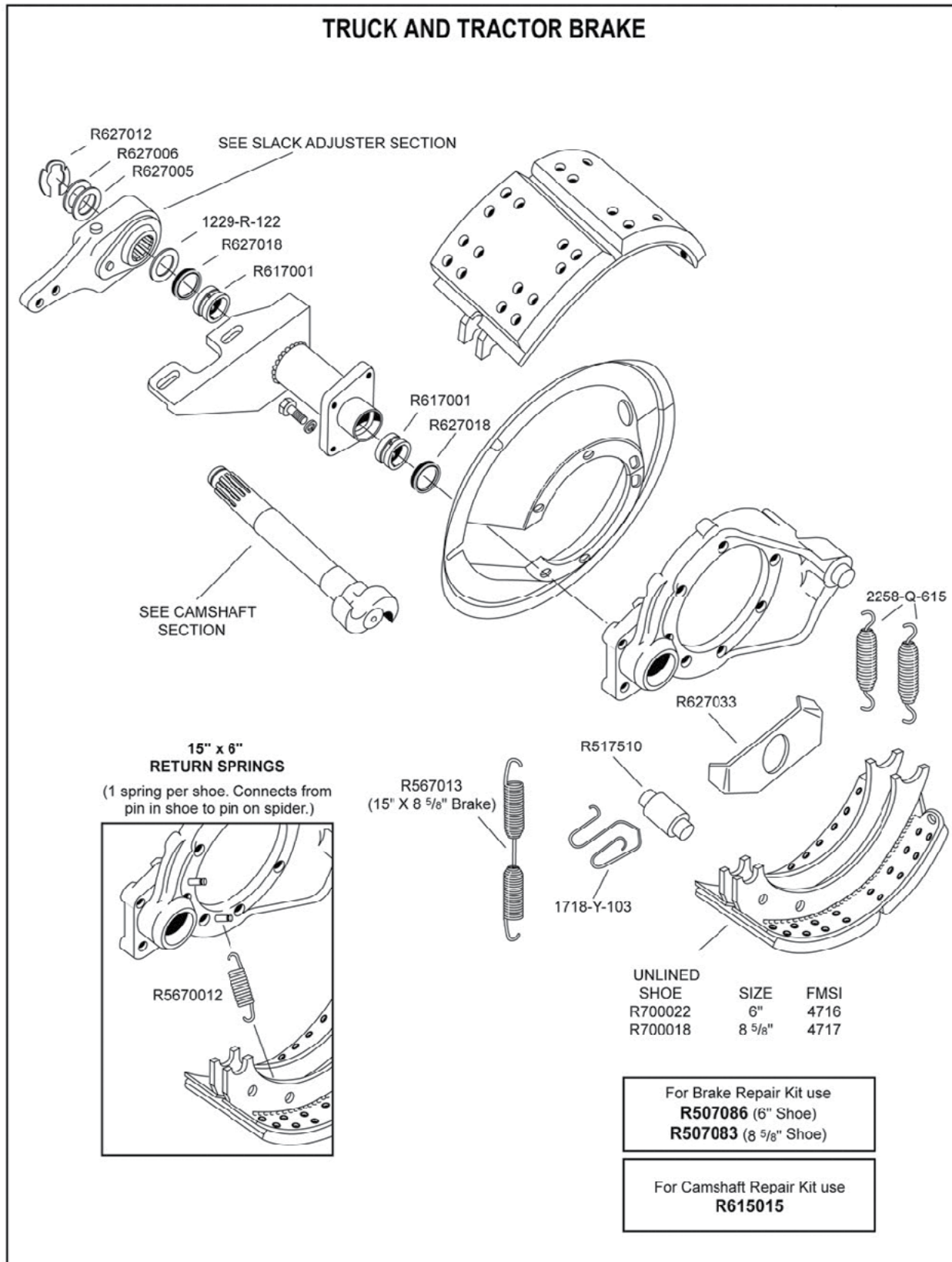
EATON 15" DIA. STANDARD & "ES" "EXTENDED SERVICE" BRAKES



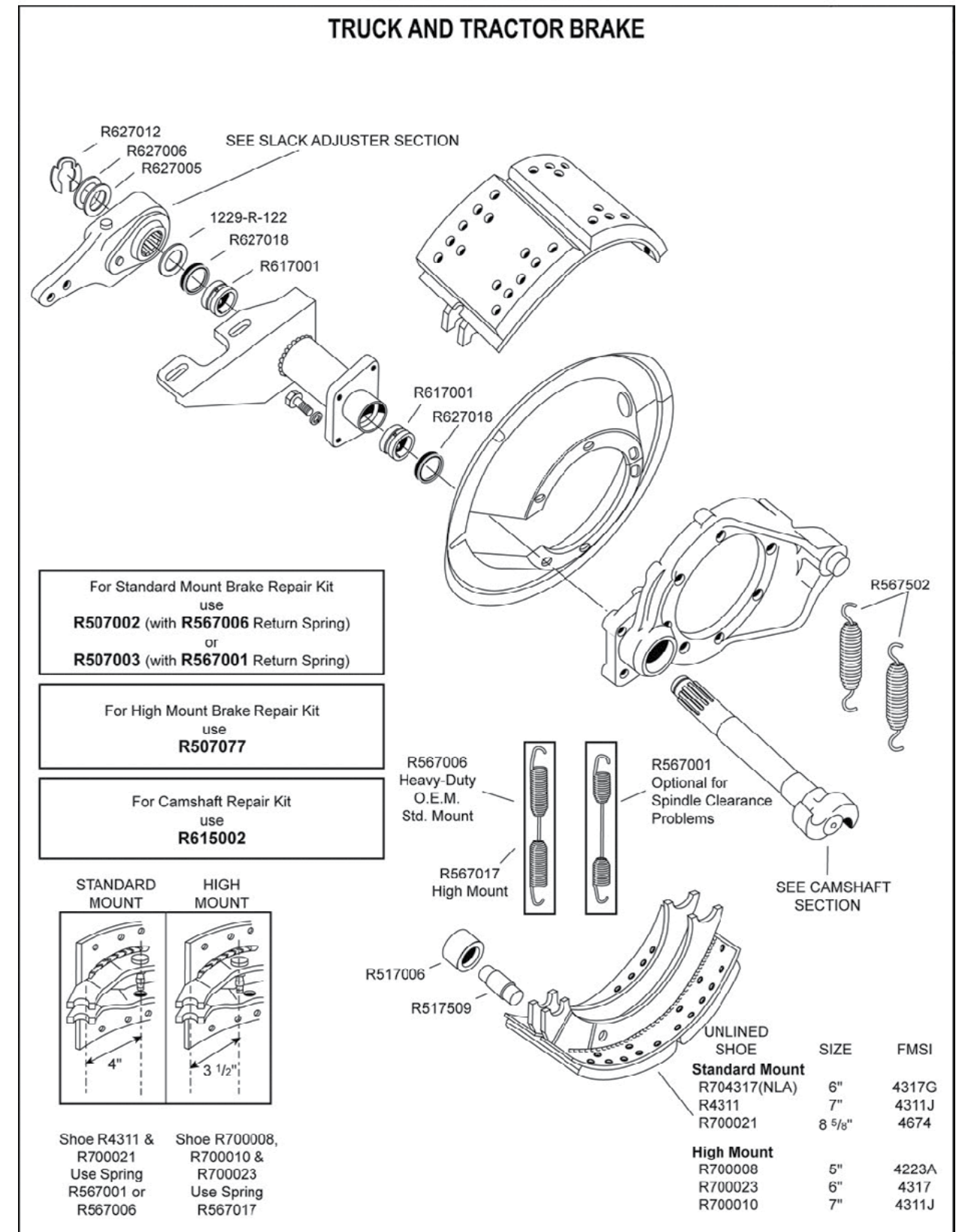
EATON 15" DIA. STANDARD & "ES" "EXTENDED SERVICE" BRAKES



**EATON 15" DIAMETER
"REDUCED ENVELOPE" BRAKES
TRUCK AND TRACTOR BRAKE**

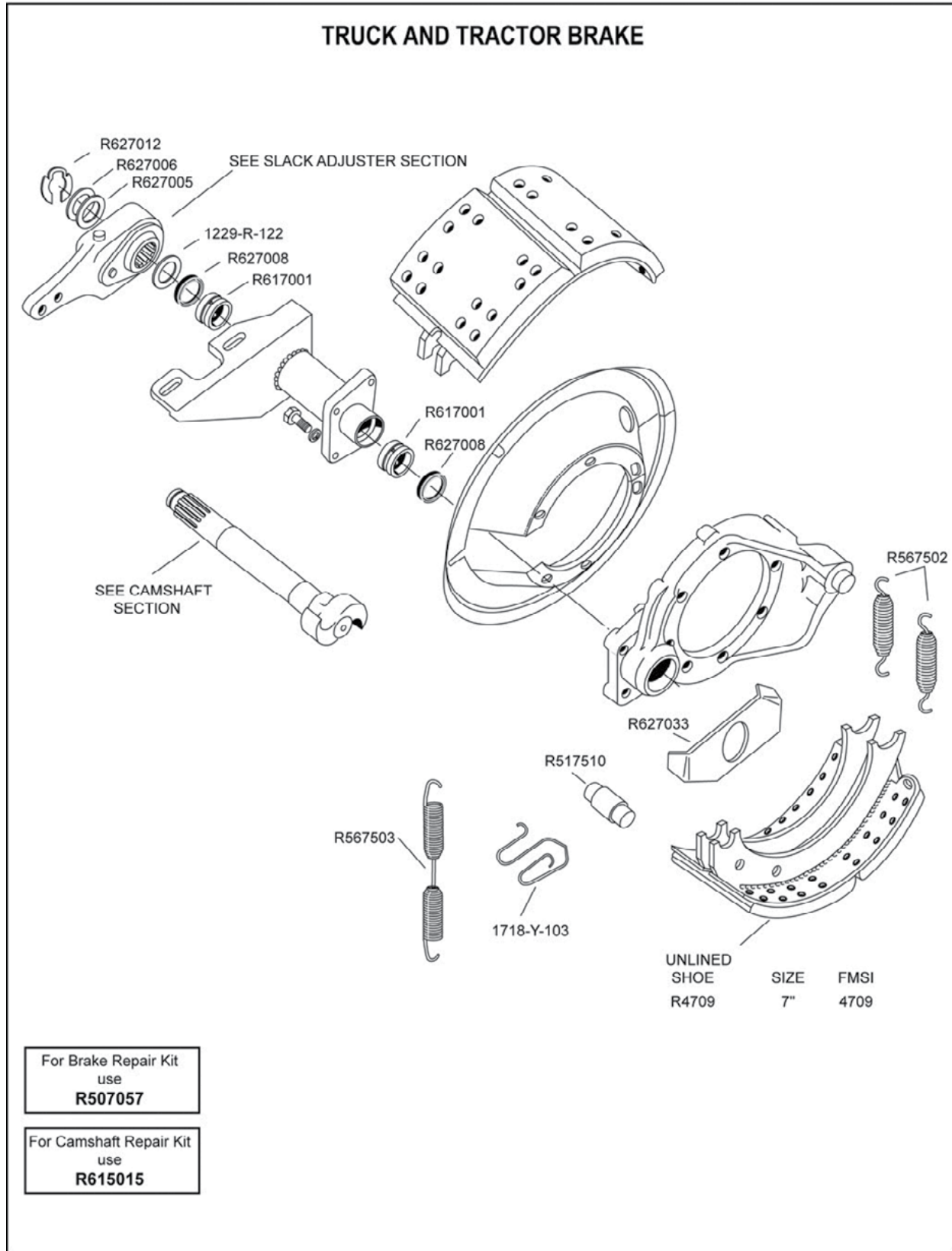


**EATON 16-1/2" DIAMETER
541 SERIES BRAKES
TRUCK AND TRACTOR BRAKE**



**EATON 16 1/2" DIAMETER
"ES" "EXTENDED SERVICE" BRAKES**

TRUCK AND TRACTOR BRAKE

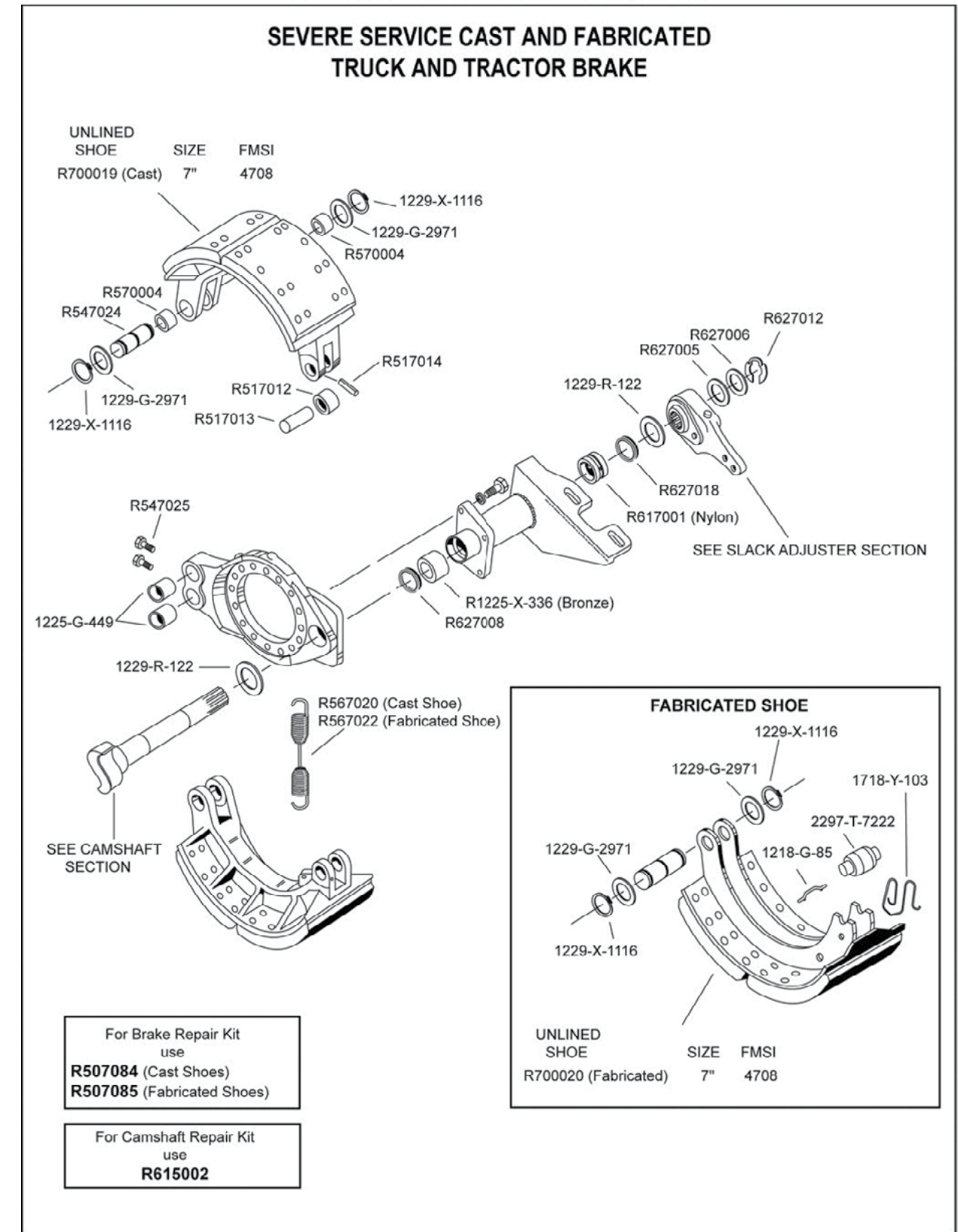


For Brake Repair Kit
use
R507057

For Camshaft Repair Kit
use
R615015

**EATON 16 1/2" DIAMETER
"ES" "EXTENDED SERVICE" BRAKES**

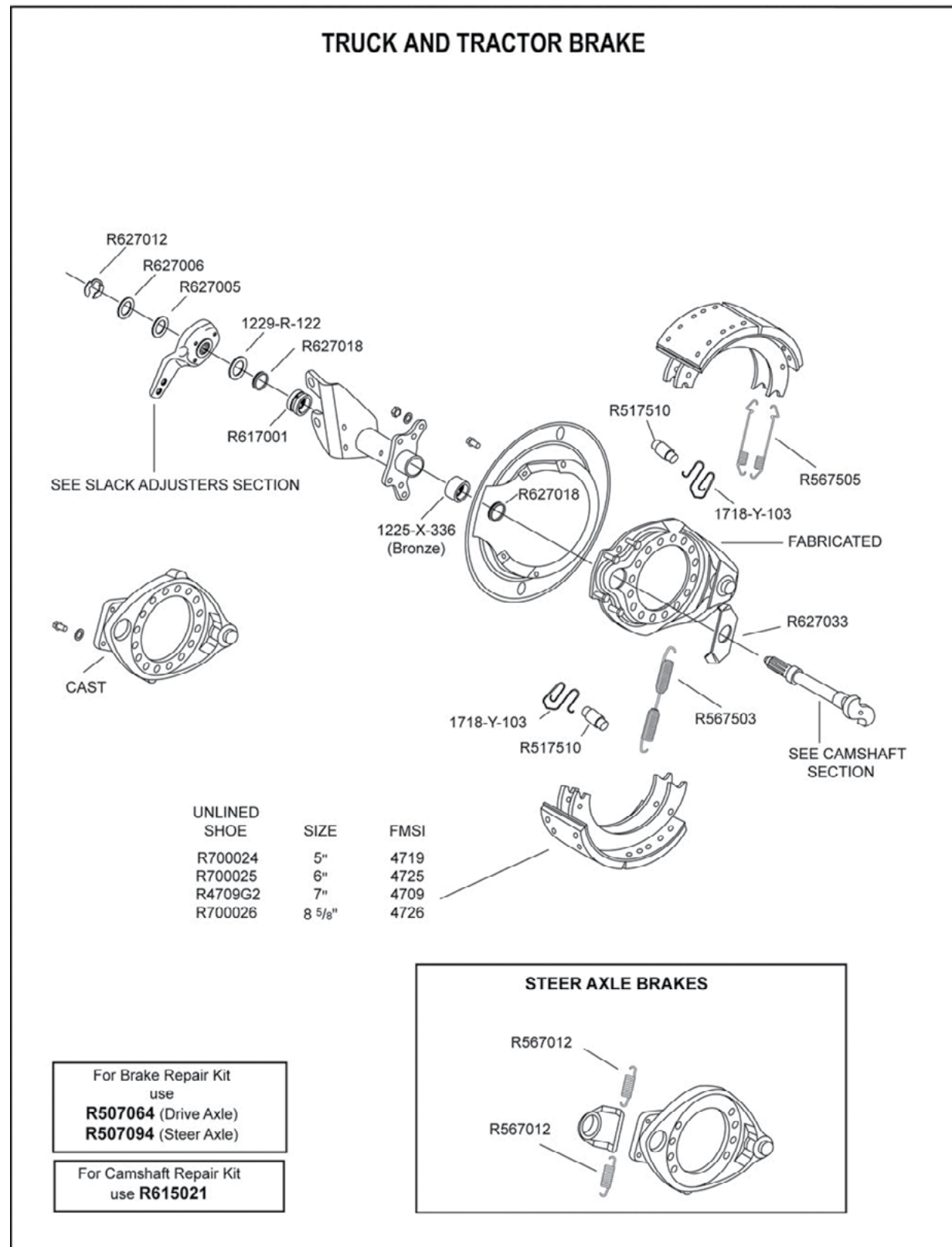
**SEVERE SERVICE CAST AND FABRICATED
TRUCK AND TRACTOR BRAKE**



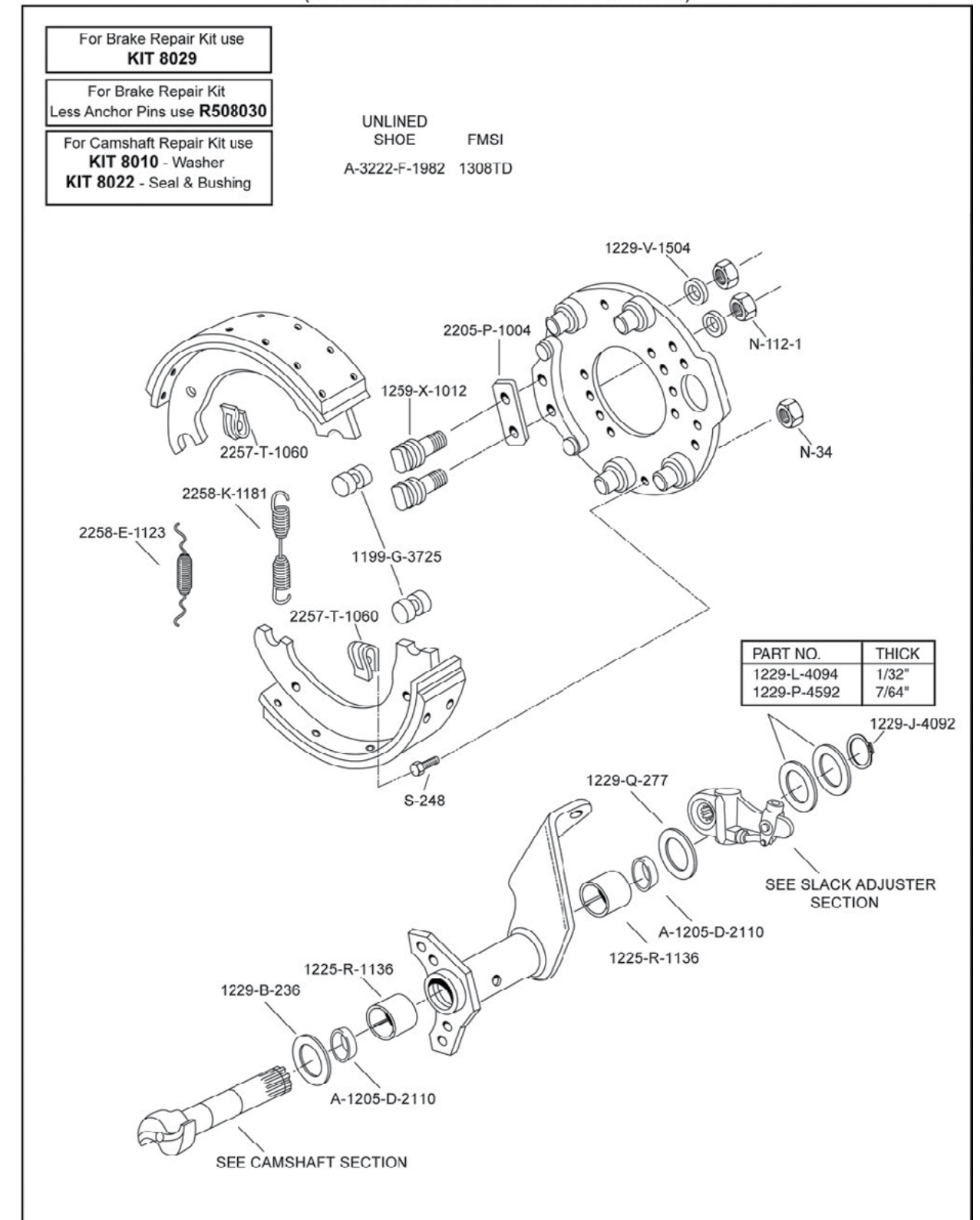
For Brake Repair Kit
use
R507084 (Cast Shoes)
R507085 (Fabricated Shoes)

For Camshaft Repair Kit
use
R615002

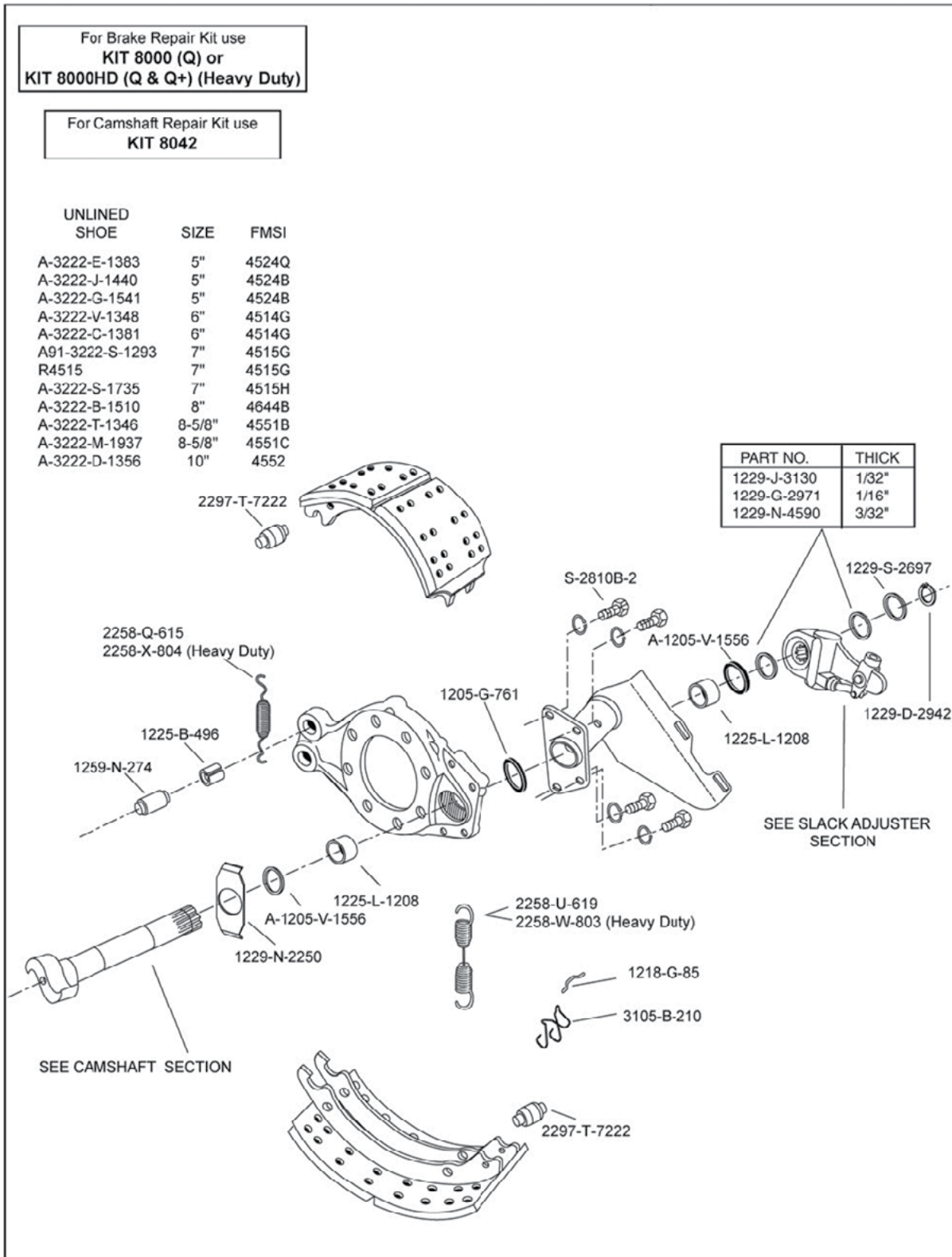
**EATON 16-1/2" DIAMETER
"ES II" "EXTENDED SERVICE" BRAKES**



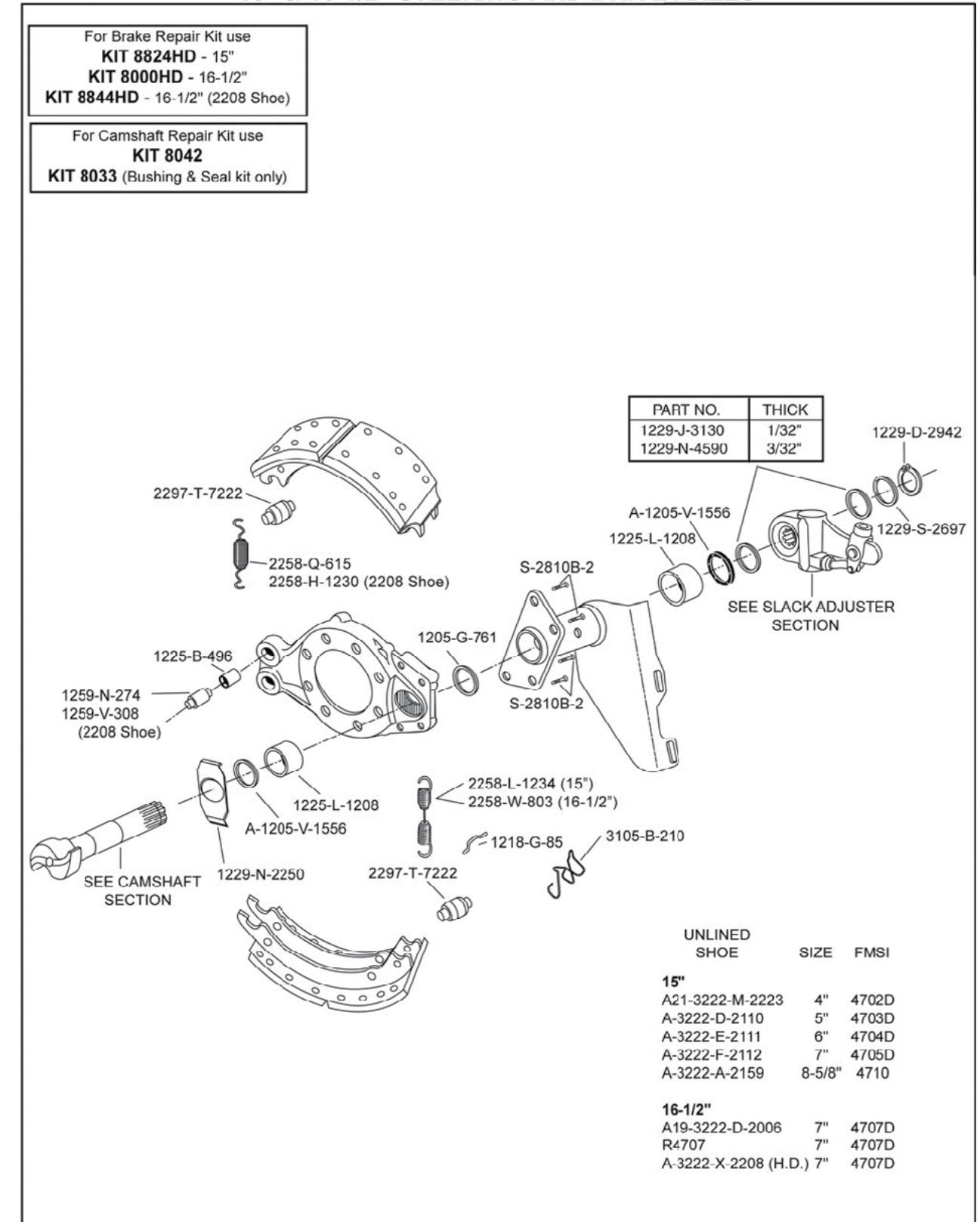
**MERITOR "Q" SERIES CAM BRAKES FOR
15" x 4" STEERING AND DRIVE AXLES
(CANNOT BE UPGRADED TO Q PLUS)**



**MERITOR "Q" SERIES CAM BRAKES FOR
16-1/2" x 5", 6", 7", 8-5/8" & 10" STEERING AND DRIVE AXLES
(7" CAN BE UPGRADED TO "Q PLUS")**



**MERITOR "Q PLUS" SERIES CAM BRAKES FOR
15" & 16-1/2" STEERING AND DRIVE AXLES**

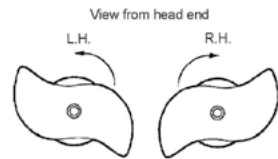


10 SPLINE / 1-1/2" DIAMETER

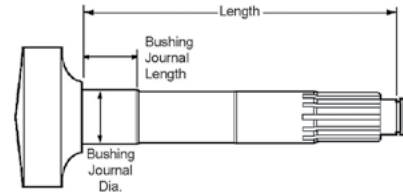
- Use Brake repair kit: R507002

Use Camshaft repair kit: R615002

Use Camshaft Repair Kit: R615002
Use Brake Repair Kit: R507002



NOTE: LH and RH indicates only the direction of cam rotation; NOT which side of the vehicle the cam is used on. (LH = Counterclockwise) (RH = Clockwise)



NOTE: All camshaft lengths are measured to the beginning of the snap ring groove.

Table 1-56: Eaton Drive Axles with 16-1/2" and 18" brakes

Part Number	Description	Head End	Effective Length	Bushing Journal Length	Bushing Journal Diameter
-------------	-------------	----------	------------------	------------------------	--------------------------

EATON DRIVE AXLES WITH 16-1/2" AND 18" BRAKES

R607036	S-Cam - 1-1/2" -10 spline for Eaton Drive Axles with 16-1/2" and 18" brakes	LH	8-19/32"	1-21/32"	1-1/2"
R607035	S-Cam - 1-1/2" -10 spline for Eaton Drive Axles with 16-1/2" and 18" brakes	RH	8-19/32"	1-21/32"	1-1/2"
R607147	S-Cam - 1-1/2" -10 spline for Eaton Drive Axles with 16-1/2" and 18" brakes	LH	10-13/64"	1-21/32"	1-1/2"
R607148	S-Cam - 1-1/2" -10 spline for Eaton Drive Axles with 16-1/2" and 18" brakes	RH	10-13/64"	1-21/32"	1-1/2"
R607018	S-Cam - 1-1/2" -10 spline for Eaton Drive Axles with 16-1/2" and 18" brakes	LH	10-9/32"	1-27/32"	1-1/2"
R607017	S-Cam - 1-1/2" -10 spline for Eaton Drive Axles with 16-1/2" and 18" brakes	RH	10-9/32"	1-27/32"	1-1/2"
R607261	S-Cam - 1-1/2" -10 spline for Eaton Drive Axles with 16-1/2" and 18" brakes	LH	10-1/2"	n/a	1-1/2"
R607262	S-Cam - 1-1/2" -10 spline for Eaton Drive Axles with 16-1/2" and 18" brakes	RH	10-1/2"	n/a	1-1/2"
R607149	S-Cam - 1-1/2" -10 spline for Eaton Drive Axles with 16-1/2" and 18" brakes	LH	11-5/32"	1-21/32"	1-1/2"
R607150	S-Cam - 1-1/2" -10 spline for Eaton Drive Axles with 16-1/2" and 18" brakes	RH	11-5/32"	1-21/32"	1-1/2"
R607016	S-Cam - 1-1/2" -10 spline for Eaton Drive Axles with 16-1/2" and 18" brakes	LH	11-33/64"	1-21/32"	1-1/2"
R607015	S-Cam - 1-1/2" -10 spline for Eaton Drive Axles with 16-1/2" and 18" brakes	RH	11-33/64"	1-21/32"	1-1/2"
R607030	S-Cam - 1-1/2" -10 spline for Eaton Drive Axles with 16-1/2" and 18" brakes	LH	12-29/64"	1-21/32"	1-1/2"
R607029	S-Cam - 1-1/2" -10 spline for Eaton Drive Axles with 16-1/2" and 18" brakes	RH	12-29/64"	1-21/32"	1-1/2"
R607125	S-Cam - 1-1/2" -10 spline for Eaton Drive Axles with 16-1/2" and 18" brakes	LH	12-61/64"	1-21/32"	1-1/2"
R607126	S-Cam - 1-1/2" -10 spline for Eaton Drive Axles with 16-1/2" and 18" brakes	RH	12-61/64"	1-21/32"	1-1/2"

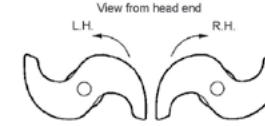
Information & Images Provided by Meritor

EATON ES - II

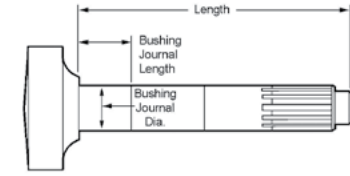
- For "ES-II" axle, use brake repair kit: R507057
- For "ES-II" Drive Axle use brake repair kit: R507064
- For "ES-II" Steer Axle, use brake repair kit: R507094

Use Camshaft repair kit: R615021

Use Camshaft Repair Kit: R615021
Use Brake Repair Kit: R507057 "ES-I"
R507064 "ES-II" Drive Axle
R507094 "ES-II" Steer Axle



NOTE: LH and RH indicates only the direction of cam rotation; NOT which side of the vehicle the cam is used on. (LH = Counterclockwise) (RH = Clockwise)



NOTE: All camshaft lengths are measured to the beginning of the snap ring groove.

Table 1-57: Eaton Drive Axles with 16-1/2" ES (Extended Service) and 15" Reduced Envelope brakes

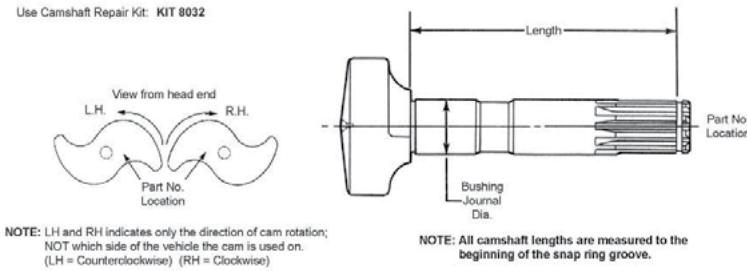
Part Number	Description	Head End	Effective Length	Bushing Journal Length	Bushing Journal Diameter
-------------	-------------	----------	------------------	------------------------	--------------------------

EATON DRIVE AXLES WITH 16-1/2" ES (EXTENDED SERVICE) AND 15" REDUCED ENVELOPE BRAKES

R607111	S-Cam - 1-1/2" - 10 spline for Eaton Drive Axles with 16-1/2" ES (Extended Service) and 15" Reduced Envelope brakes	LH	8-21/32"	1-23/32"	1-1/2"
R607112	S-Cam - 1-1/2" - 10 spline for Eaton Drive Axles with 16-1/2" ES (Extended Service) and 15" Reduced Envelope brakes	RH	8-21/32"	1-23/32"	1-1/2"
R607151	S-Cam - 1-1/2" - 10 spline for Eaton Drive Axles with 16-1/2" ES (Extended Service) and 15" Reduced Envelope brakes	LH	10-9/16"	1-23/32"	1-1/2"
R607152	S-Cam - 1-1/2" - 10 spline for Eaton Drive Axles with 16-1/2" ES (Extended Service) and 15" Reduced Envelope brakes	RH	10-9/16"	1-23/32"	1-1/2"
R607105	S-Cam - 1-1/2" - 10 spline for Eaton Drive Axles with 16-1/2" ES (Extended Service) and 15" Reduced Envelope brakes	LH	11-9/16"	1-23/32"	1-1/2"
R607106	S-Cam - 1-1/2" - 10 spline for Eaton Drive Axles with 16-1/2" ES (Extended Service) and 15" Reduced Envelope brakes	RH	11-9/16"	1-23/32"	1-1/2"
R607153	S-Cam - 1-1/2" - 10 spline for Eaton Drive Axles with 16-1/2" ES (Extended Service) and 15" Reduced Envelope brakes	LH	12-17/32"	1-23/32"	1-1/2"
R607154	S-Cam - 1-1/2" - 10 spline for Eaton Drive Axles with 16-1/2" ES (Extended Service) and 15" Reduced Envelope brakes	RH	12-17/32"	1-23/32"	1-1/2"
R607279	S-Cam - 1-1/2" - 10 spline for Eaton Drive Axles with 16-1/2" ES (Extended Service) and 15" Reduced Envelope brakes	LH	13-15/32"	n/a	1-1/2"
R607280	S-Cam - 1-1/2" - 10 spline for Eaton Drive Axles with 16-1/2" ES (Extended Service) and 15" Reduced Envelope brakes	RH	13-15/32"	n/a	1-1/2"
R607155	S-Cam - 1-1/2" - 10 spline for Eaton Drive Axles with 16-1/2" ES (Extended Service) and 15" Reduced Envelope brakes	LH	14-11/32"	1-23/32"	1-1/2"
R607156	S-Cam - 1-1/2" - 10 spline for Eaton Drive Axles with 16-1/2" ES (Extended Service) and 15" Reduced Envelope brakes	RH	14-11/32"	1-23/32"	1-1/2"
R607281	S-Cam - 1-1/2" - 10 spline for Eaton Drive Axles with 16-1/2" ES (Extended Service) and 15" Reduced Envelope brakes	LH	15-1/16"	n/a	1-1/2"
R607282	S-Cam - 1-1/2" - 10 spline for Eaton Drive Axles with 16-1/2" ES (Extended Service) and 15" Reduced Envelope brakes	RH	15-1/16"	n/a	1-1/2"
R607283	S-Cam - 1-1/2" - 10 spline for Eaton Drive Axles with 16-1/2" ES (Extended Service) and 15" Reduced Envelope brakes	LH	15-1/4"	n/a	1-1/2"
R607284	S-Cam - 1-1/2" - 10 spline for Eaton Drive Axles with 16-1/2" ES (Extended Service) and 15" Reduced Envelope brakes	RH	15-1/4"	n/a	1-1/2"

TRANSIT APPLICATIONS WITH MERITOR BRAKES

- All camshaft lengths are measured to the beginning of the snap ring groove.
- NOTE: LH and RH indicates only the direction of cam rotation; NOT which side of the vehicle the cam is used on



For all S-Camshaft repairs, also order Camshaft repair Kit: K1T8032

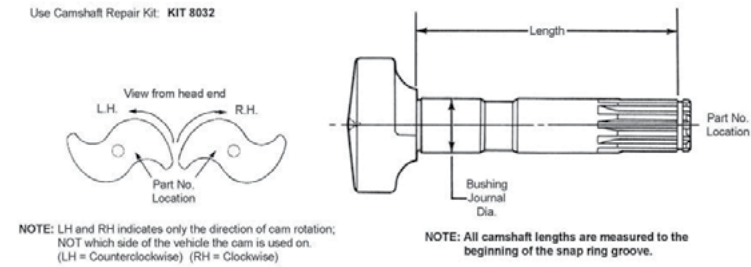
Table 1-58: Transit applications with Meritor brakes

Part Number	Description	Head End	Effective Length	Bushing Journal Diameter	Application Information
221DX5536	S-Cam - 1-1/2" -10 spline for transit applications with Meritor brakes	LH	7-23/32"	1-1/2"	Chrome plated. 3.88" diameter forged head.
221DW5535	S-Cam - 1-1/2" -10 spline for transit applications with Meritor brakes	RH	7-23/32"	1-1/2"	Chrome plated. 3.88" diameter forged head.
221DL6304	S-Cam - 1-1/2" -10 spline for transit applications with Meritor brakes	LH	9-5/16"	1-1/2"	3.88" diameter forged head.
221DK6303	S-Cam - 1-1/2" -10 spline for transit applications with Meritor brakes	RH	9-5/16"	1-1/2"	3.88" diameter forged head.
221DP5164	S-Cam - 1-1/2" -10 spline for transit applications with Meritor brakes	LH	9-63/64"	1-1/2"	3.75" diameter machined head.
2210Q5165	S-Cam - 1-1/2" -10 spline for transit applications with Meritor brakes	RH	9-63/64"	1-1/2"	3.75" diameter machined head.
221DH5754	S-Cam - 1-1/2" -10 spline for transit applications with Meritor brakes	LH	10-1/32"	1-1/2"	3.88" diameter forged head.
221DG5753	S-Cam - 1-1/2" -10 spline for transit applications with Meritor brakes	RH	10-1/32"	1-1/2"	3.88" diameter forged head.
221DP8200	S-Cam - 1-1/2" -10 spline for transit applications with Meritor brakes	LH	10-5/8"	1-1/2"	3.88" diameter forged head.
221DN8204	S-Cam - 1-1/2" -10 spline for transit applications with Meritor brakes	RH	10-5/8"	1-1/2"	3.88" diameter forged head.
221DG6299	S-Cam - 1-1/2" -10 spline for transit applications with Meritor brakes	LH	15-7/8"	1-1/2"	3.88" diameter forged head.
221DF6298	S-Cam - 1-1/2" -10 spline for transit applications with Meritor brakes	RH	15-7/8"	1-1/2"	3.88" diameter forged head.
221DL6538	S-Cam - 1-1/2" -10 spline for transit applications with Meritor brakes	LH	18-1/2"	1-1/2"	3.88" diameter forged head.
221DK6537	S-Cam - 1-1/2" -10 spline for transit applications with Meritor brakes	RH	18-1/2"	1-1/2"	3.88" diameter forged head.
2210U4909	S-Cam - 1-1/2" -10 spline for transit applications with Meritor brakes	LH	5-13/64"	1-1/2"	3.88" diameter forged head.
2210V4910	S-Cam - 1-1/2" -10 spline for transit applications with Meritor brakes	RH	5-13/64"	1-1/2"	3.88" diameter forged head.
2210Q4905	S-Cam - 1-1/2" -10 spline for transit applications with Meritor brakes	LH	5-3/8"	1-1/2"	3.88" diameter forged head.
2210R4906	S-Cam - 1-1/2" -10 spline for transit applications with Meritor brakes	RH	5-3/8"	1-1/2"	3.88" diameter forged head.
2210A4915	S-Cam - 1-1/2" -10 spline for transit applications with Meritor brakes	LH	5-19/32"	1-1/2"	3.88" diameter forged head.
2210B4916	S-Cam - 1-1/2" -10 spline for transit applications with Meritor brakes	RH	5-19/32"	1-1/2"	3.88" diameter forged head.
2210S4907	S-Cam - 1-1/2" -10 spline for transit applications with Meritor brakes	LH	6-1/4"	1-1/2"	3.88" diameter forged head.
2210T4908	S-Cam - 1-1/2" -10 spline for transit applications with Meritor brakes	RH	6-1/4"	1-1/2"	3.88" diameter forged head.
2210A6813	S-Cam - 1-1/2" -10 spline for transit applications with Meritor brakes	LH	17"	1-1/2"	3.88" diameter forged head.
2210Z6812	S-Cam - 1-1/2" -10 spline for transit applications with Meritor brakes	RH	17"	1-1/2"	3.88" diameter forged head.
2210Z8294	S-Cam - 1-1/2" -10 spline for transit applications with Meritor brakes	LH	17-1/8"	1-1/2"	3.88" diameter forged head.
2210Y8293	S-Cam - 1-1/2" -10 spline for transit applications with Meritor brakes	RH	17-1/8"	1-1/2"	3.88" diameter forged head.

Information & Images Provided by Meritor

TRANSIT APPLICATIONS WITH MERITOR BRAKES WITH HEAD END SNAP RING GROOVE

- All camshaft lengths are measured to the beginning of the snap ring groove.
- NOTE: LH and RH indicates only the direction of cam rotation; NOT which side of the vehicle the cam is used on



For all S-Camshaft repairs, also order Camshaft repair Kit: K1T8032

Table 1-59: Transit applications with Meritor brakes with Head End Snap Ring Groove

Part Number	Description	Head End	Effective Length	Under Head to Snap Ring Groove	Bushing Journal Diameter
2210H8432	S-Cam - 1-1/2" -10 spline for transit applications with Meritor brakes with Head End Snap Ring Groove	LH	13-39/64"	3-53/64"	1-1/2"
2210G8431	S-Cam - 1-1/2" -10 spline for transit applications with Meritor brakes with Head End Snap Ring Groove	RH	13-39/64"	3-53/64"	1-1/2"
2210Y6005	S-Cam - 1-1/2" -10 spline for transit applications with Meritor brakes with Head End Snap Ring Groove	LH	14-25/32"	3-53/64"	1-1/2"
2210Z6006	S-Cam - 1-1/2" -10 spline for transit applications with Meritor brakes with Head End Snap Ring Groove	RH	14-25/32"	3-53/64"	1-1/2"
2210A6007	S-Cam - 1-1/2" -10 spline for transit applications with Meritor brakes with Head End Snap Ring Groove	LH	17-25/32"	3-53/64"	1-1/2"
2210B6008	S-Cam - 1-1/2" -10 spline for transit applications with Meritor brakes with Head End Snap Ring Groove	RH	17-25/32"	3-53/64"	1-1/2"

Information & Images Provided by Meritor

28 SPLINE / 1-1/2" DIAMETER

- For "LX/ MX" brakes, use Camshaft repair kit: KIT8883
- For 16-1/2" brakes, use brake repair kit: KIT8000HD
- For 15" brakes, use brake repair kit: KIT8824HD or R509013

Use Camshaft repair kit: K1T8042

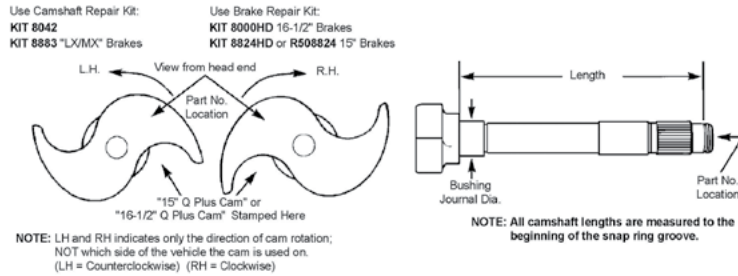


Table 1-60: Meritor "Q Plus" brakes

Part Number	Description	Head End	Effective Length	Bushing Journal Diameter	Application Information
MERITOR "Q PLUS" BRAKES					
2210L7344	S-Cam - 1-1/2" -28 spline for Meritor "Q Plus" brakes	LH	6-13/64"	1-1/2"	16-1/2" brakes.
2210K7343	S-Cam - 1-1/2" -28 spline for Meritor "Q Plus" brakes	RH	6-13/64"	1-1/2"	16-1/2" brakes.
2210Q7375	S-Cam - 1-1/2" -28 spline for Meritor "Q Plus" brakes	LH	7-3/32"	1-1/2"	16-1/2" brakes.
2210P7374	S-Cam - 1-1/2" -28 spline for Meritor "Q Plus" brakes	RH	7-3/32"	1-1/2"	16-1/2" brakes.
2210K8331	S-Cam - 1-1/2" -28 spline for Meritor "Q Plus" brakes	LH	7-31/64"	1-5/8"	16-1/2" brakes. LX/MX 500 Series
2210J8330	S-Cam - 1-1/2" -28 spline for Meritor "Q Plus" brakes	RH	7-31/64"	1-5/8"	16-1/2" brakes. LX/MX 500 Series
2210L7396	S-Cam - 1-1/2" -28 spline for Meritor "Q Plus" brakes	LH	7-45/64"	1-1/2"	16-1/2" brakes.
2210K7395	S-Cam - 1-1/2" -28 spline for Meritor "Q Plus" brakes	RH	7-45/64"	1-1/2"	16-1/2" brakes.
2210Y7409	S-Cam - 1-1/2" -28 spline for Meritor "Q Plus" brakes	LH	8-3/32"	1-1/2"	16-1/2" brakes.
2210X7408	S-Cam - 1-1/2" -28 spline for Meritor "Q Plus" brakes	RH	8-3/32"	1-1/2"	16-1/2" brakes.
2210C7413	S-Cam - 1-1/2" -28 spline for Meritor "Q Plus" brakes	LH	8-13/64"	1-1/2"	16-1/2" brakes.
2210B7412	S-Cam - 1-1/2" -28 spline for Meritor "Q Plus" brakes	RH	8-13/64"	1-1/2"	16-1/2" brakes.
2210G7417	S-Cam - 1-1/2" -28 spline for Meritor "Q Plus" brakes	LH	8-5/16"	1-1/2"	16-1/2" brakes.
2210F7416	S-Cam - 1-1/2" -28 spline for Meritor "Q Plus" brakes	RH	8-5/16"	1-1/2"	16-1/2" brakes.
2210H7418	S-Cam - 1-1/2" -28 spline for Meritor "Q Plus" brakes	LH	8-29/64"	1-1/2"	15" brakes.
2210J7420	S-Cam - 1-1/2" -28 spline for Meritor "Q Plus" brakes	RH	8-29/64"	1-1/2"	15" brakes.
2210X8318	S-Cam - 1-1/2" -28 spline for Meritor "Q Plus" brakes	LH	8-37/64"	1-5/8"	16-1/2" brakes. LX/MX 500 Series
2210W8317	S-Cam - 1-1/2" -28 spline for Meritor "Q Plus" brakes	RH	8-37/64"	1-5/8"	16-1/2" brakes. LX/MX 500 Series
2210Q7427	S-Cam - 1-1/2" -28 spline for Meritor "Q Plus" brakes	LH	8-19/32"	1-1/2"	16-1/2" brakes.
2210P7426	S-Cam - 1-1/2" -28 spline for Meritor "Q Plus" brakes	RH	8-19/32"	1-1/2"	16-1/2" brakes.
2210R7428	S-Cam - 1-1/2" -28 spline for Meritor "Q Plus" brakes	LH	8-45/64"	1-1/2"	15" brakes.
2210S7429	S-Cam - 1-1/2" -28 spline for Meritor "Q Plus" brakes	RH	8-45/64"	1-1/2"	15" brakes.
2210U7431	S-Cam - 1-1/2" -28 spline for Meritor "Q Plus" brakes	LH	8-45/64"	1-1/2"	16-1/2" brakes.
2210T7430	S-Cam - 1-1/2" -28 spline for Meritor "Q Plus" brakes	RH	8-45/64"	1-1/2"	16-1/2" brakes.

Information & Images Provided by Meritor

Part Number	Description	Head End	Effective Length	Bushing Journal Diameter	Application Information
2210Q8181	S-Cam - 1-1/2" -28 spline for Meritor "Q Plus" brakes	LH	8-45/64"	1-5/8"	15" brakes. LX/MX 500 Series
2210R8182	S-Cam - 1-1/2" -28 spline for Meritor "Q Plus" brakes	RH	8-45/64"	1-5/8"	15" brakes. LX/MX 500 Series
2210G7443	S-Cam - 1-1/2" -28 spline for Meritor "Q Plus" brakes	LH	9-3/32"	1-1/2"	16-1/2" brakes.
2210F7442	S-Cam - 1-1/2" -28 spline for Meritor "Q Plus" brakes	RH	9-3/32"	1-1/2"	16-1/2" brakes.
2210T8184	S-Cam - 1-1/2" -28 spline for Meritor "Q Plus" brakes	LH	9-5/16"	1-5/8"	16-1/2" brakes. LX/MX 500 Series
2210S8183	S-Cam - 1-1/2" -28 spline for Meritor "Q Plus" brakes	RH	9-5/16"	1-5/8"	16-1/2" brakes. LX/MX 500 Series
2210M7449	S-Cam - 1-1/2" -28 spline for Meritor "Q Plus" brakes	LH	9-5/16"	1-1/2"	15" brakes.
2210N7450	S-Cam - 1-1/2" -28 spline for Meritor "Q Plus" brakes	RH	9-5/16"	1-1/2"	15" brakes.
2210Q7453	S-Cam - 1-1/2" -28 spline for Meritor "Q Plus" brakes	LH	9-5/16"	1-1/2"	16-1/2" brakes.
2210P7452	S-Cam - 1-1/2" -28 spline for Meritor "Q Plus" brakes	RH	9-5/16"	1-1/2"	16-1/2" brakes.
2210R7454	S-Cam - 1-1/2" -28 spline for Meritor "Q Plus" brakes	LH	9-29/64"	1-1/2"	15" brakes.
2210S7455	S-Cam - 1-1/2" -28 spline for Meritor "Q Plus" brakes	RH	9-29/64"	1-1/2"	15" brakes.
2210U7457	S-Cam - 1-1/2" -28 spline for Meritor "Q Plus" brakes	LH	9-29/64"	1-1/2"	16-1/2" brakes.
2210T7456	S-Cam - 1-1/2" -28 spline for Meritor "Q Plus" brakes	RH	9-29/64"	1-1/2"	16-1/2" brakes.
2210Z8346	S-Cam - 1-1/2" -28 spline for Meritor "Q Plus" brakes	LH	9-37/64"	1-5/8"	16-1/2" brakes. LX/MX 500 Series
2210Y8345	S-Cam - 1-1/2" -28 spline for Meritor "Q Plus" brakes	RH	9-37/64"	1-5/8"	16-1/2" brakes. LX/MX 500 Series
2210C7465	S-Cam - 1-1/2" -28 spline for Meritor "Q Plus" brakes	LH	9-45/64"	1-1/2"	16-1/2" brakes.
2210B7464	S-Cam - 1-1/2" -28 spline for Meritor "Q Plus" brakes	RH	9-45/64"	1-1/2"	16-1/2" brakes.
2210G7469	S-Cam - 1-1/2" -28 spline for Meritor "Q Plus" brakes	LH	9-13/16"	1-1/2"	16-1/2" brakes.
2210F7468	S-Cam - 1-1/2" -28 spline for Meritor "Q Plus" brakes	RH	9-13/16"	1-1/2"	16-1/2" brakes.
2210L7474	S-Cam - 1-1/2" -28 spline for Meritor "Q Plus" brakes	LH	9-61/64"	1-1/2"	16-1/2" brakes.
2210K7473	S-Cam - 1-1/2" -28 spline for Meritor "Q Plus" brakes	RH	9-61/64"	1-1/2"	16-1/2" brakes.
2210Q7479	S-Cam - 1-1/2" -28 spline for Meritor "Q Plus" brakes	LH	10-3/32"	1-1/2"	16-1/2" brakes.
2210P7478	S-Cam - 1-1/2" -28 spline for Meritor "Q Plus" brakes	RH	10-3/32"	1-1/2"	16-1/2" brakes.
2210W7485	S-Cam - 1-1/2" -28 spline for Meritor "Q Plus" brakes	LH	10-13/64"	1-1/2"	16-1/2" brakes.
2210V7484	S-Cam - 1-1/2" -28 spline for Meritor "Q Plus" brakes	RH	10-13/64"	1-1/2"	16-1/2" brakes.
2210E7493	S-Cam - 1-1/2" -28 spline for Meritor "Q Plus" brakes	LH	10-29/64"	1-1/2"	16-1/2" brakes.
2210D7492	S-Cam - 1-1/2" -28 spline for Meritor "Q Plus" brakes	RH	10-29/64"	1-1/2"	16-1/2" brakes.
2210H7496	S-Cam - 1-1/2" -28 spline for Meritor "Q Plus" brakes	LH	10-33/64"	1-1/2"	15" brakes.
2210J7498	S-Cam - 1-1/2" -28 spline for Meritor "Q Plus" brakes	RH	10-33/64"	1-1/2"	15" brakes.
2210X8370	S-Cam - 1-1/2" -28 spline for Meritor "Q Plus" brakes	LH	10-37/64"	1-5/8"	16-1/2" brakes. LX/MX 500 Series
2210W8369	S-Cam - 1-1/2" -28 spline for Meritor "Q Plus" brakes	RH	10-37/64"	1-5/8"	16-1/2" brakes. LX/MX 500 Series
2210L7500	S-Cam - 1-1/2" -28 spline for Meritor "Q Plus" brakes	LH	10-19/32"	1-1/2"	16-1/2" brakes.
2210K7499	S-Cam - 1-1/2" -28 spline for Meritor "Q Plus" brakes	RH	10-19/32"	1-1/2"	16-1/2" brakes.
2210N7502	S-Cam - 1-1/2" -28 spline for Meritor "Q Plus" brakes	LH	10-19/32"	1-1/2"	16-1/2" brakes. Induction hardened body.
2210M7501	S-Cam - 1-1/2" -28 spline for Meritor "Q Plus" brakes	RH	10-19/32"	1-1/2"	16-1/2" brakes. Induction hardened body.
2210Q7843	S-Cam - 1-1/2" -28 spline for Meritor "Q Plus" brakes	LH	10-45/64"	1-1/2"	16-1/2" brakes.
2210P7842	S-Cam - 1-1/2" -28 spline for Meritor "Q Plus" brakes	RH	10-45/64"	1-1/2"	16-1/2" brakes.

Information & Images Provided by Meritor

Part Number	Description	Head End	Effective Length	Bushing Journal Diameter	Application Information
2210R8286	S-Cam - 1-1/2" -28 spline for Meritor "Q Plus" brakes	LH	10-45/64"	1-5/8"	16-1/2" brakes. LX/MX 500 Series
2210Q8285	S-Cam - 1-1/2" -28 spline for Meritor "Q Plus" brakes	RH	10-45/64"	1-5/8"	16-1/2" brakes. LX/MX 500 Series
2210W7511	S-Cam - 1-1/2" -28 spline for Meritor "Q Plus" brakes	LH	10-13/16"	1-1/2"	16-1/2" brakes.
2210V7510	S-Cam - 1-1/2" -28 spline for Meritor "Q Plus" brakes	RH	10-13/16"	1-1/2"	16-1/2" brakes.
2210A7515	S-Cam - 1-1/2" -28 spline for Meritor "Q Plus" brakes	LH	10-61/64"	1-1/2"	16-1/2" brakes.
2210Z7514	S-Cam - 1-1/2" -28 spline for Meritor "Q Plus" brakes	RH	10-61/64"	1-1/2"	16-1/2" brakes.
2210J7524	S-Cam - 1-1/2" -28 spline for Meritor "Q Plus" brakes	LH	11-13/64"	1-1/2"	16-1/2" brakes.
2210H7522	S-Cam - 1-1/2" -28 spline for Meritor "Q Plus" brakes	RH	11-13/64"	1-1/2"	16-1/2" brakes.
2210Z8216	S-Cam - 1-1/2" -28 spline for Meritor "Q Plus" brakes	LH	11-13/64"	1-5/8"	16-1/2" brakes. LX/MX 500 Series
2210Y8215	S-Cam - 1-1/2" -28 spline for Meritor "Q Plus" brakes	RH	11-13/64"	1-5/8"	16-1/2" brakes. LX/MX 500 Series
2210P7530	S-Cam - 1-1/2" -28 spline for Meritor "Q Plus" brakes	LH	11-3/8"	1-1/2"	15" brakes.
2210Q7531	S-Cam - 1-1/2" -28 spline for Meritor "Q Plus" brakes	RH	11-3/8"	1-1/2"	15" brakes.
2210X8214	S-Cam - 1-1/2" -28 spline for Meritor "Q Plus" brakes	LH	11-37/64"	1-5/8"	16-1/2" brakes. LX/MX 500 Series
2210W8213	S-Cam - 1-1/2" -28 spline for Meritor "Q Plus" brakes	RH	11-37/64"	1-5/8"	16-1/2" brakes. LX/MX 500 Series
2210T7534	S-Cam - 1-1/2" -28 spline for Meritor "Q Plus" brakes	LH	11-19/32"	1-1/2"	15" brakes.
2210U7535	S-Cam - 1-1/2" -28 spline for Meritor "Q Plus" brakes	RH	11-19/32"	1-1/2"	15" brakes.
2210W7537	S-Cam - 1-1/2" -28 spline for Meritor "Q Plus" brakes	LH	11-19/32"	1-1/2"	16-1/2" brakes.
2210V7536	S-Cam - 1-1/2" -28 spline for Meritor "Q Plus" brakes	RH	11-19/32"	1-1/2"	16-1/2" brakes.
2210Y7539	S-Cam - 1-1/2" -28 spline for Meritor "Q Plus" brakes	LH	11-11/16"	1-1/2"	16-1/2" brakes.
2210X7538	S-Cam - 1-1/2" -28 spline for Meritor "Q Plus" brakes	RH	11-11/16"	1-1/2"	16-1/2" brakes.
2210C7543	S-Cam - 1-1/2" -28 spline for Meritor "Q Plus" brakes	LH	11-45/64"	1-1/2"	16-1/2" brakes.
2210B7542	S-Cam - 1-1/2" -28 spline for Meritor "Q Plus" brakes	RH	11-45/64"	1-1/2"	16-1/2" brakes.
2210V8316	S-Cam - 1-1/2" -28 spline for Meritor "Q Plus" brakes	LH	11-45/64"	1-5/8"	16-1/2" brakes. LX/MX 500 Series
2210U8315	S-Cam - 1-1/2" -28 spline for Meritor "Q Plus" brakes	RH	11-45/64"	1-5/8"	16-1/2" brakes. LX/MX 500 Series
2210G7547	S-Cam - 1-1/2" -28 spline for Meritor "Q Plus" brakes	LH	11-13/16"	1-1/2"	16-1/2" brakes.
2210F7546	S-Cam - 1-1/2" -28 spline for Meritor "Q Plus" brakes	RH	11-13/16"	1-1/2"	16-1/2" brakes.
2210L7552	S-Cam - 1-1/2" -28 spline for Meritor "Q Plus" brakes	LH	11-61/64"	1-1/2"	16-1/2" brakes.
2210K7551	S-Cam - 1-1/2" -28 spline for Meritor "Q Plus" brakes	RH	11-61/64"	1-1/2"	16-1/2" brakes.
2210T8288	S-Cam - 1-1/2" -28 spline for Meritor "Q Plus" brakes	LH	11-61/64"	1-5/8"	16-1/2" brakes. LX/MX 500 Series
2210S8287	S-Cam - 1-1/2" -28 spline for Meritor "Q Plus" brakes	RH	11-61/64"	1-5/8"	16-1/2" brakes. LX/MX 500 Series
2210U7561	S-Cam - 1-1/2" -28 spline for Meritor "Q Plus" brakes	LH	12-13/64"	1-1/2"	16-1/2" brakes.
2210T7560	S-Cam - 1-1/2" -28 spline for Meritor "Q Plus" brakes	RH	12-13/64"	1-1/2"	16-1/2" brakes.
2210Y7565	S-Cam - 1-1/2" -28 spline for Meritor "Q Plus" brakes	LH	12-5/16"	1-1/2"	16-1/2" brakes.
2210X7564	S-Cam - 1-1/2" -28 spline for Meritor "Q Plus" brakes	RH	12-5/16"	1-1/2"	16-1/2" brakes.
2210L7266	S-Cam - 1-1/2" -28 spline for Meritor "Q Plus" brakes	LH	12-11/32"	1-1/2"	16-1/2" brakes.
2210K7265	S-Cam - 1-1/2" -28 spline for Meritor "Q Plus" brakes	RH	12-11/32"	1-1/2"	16-1/2" brakes.
2210C7569	S-Cam - 1-1/2" -28 spline for Meritor "Q Plus" brakes	LH	12-29/64"	1-1/2"	16-1/2" brakes.
2210B7568	S-Cam - 1-1/2" -28 spline for Meritor "Q Plus" brakes	RH	12-29/64"	1-1/2"	16-1/2" brakes.
2210S7845	S-Cam - 1-1/2" -28 spline for Meritor "Q Plus" brakes	LH	12-29/64"	1-1/2"	16-1/2" brakes. Induction hardened body.

Information & Images Provided by Meritor

Part Number	Description	Head End	Effective Length	Bushing Journal Diameter	Application Information
2210R7844	S-Cam - 1-1/2" -28 spline for Meritor "Q Plus" brakes	RH	12-29/64"	1-1/2"	16-1/2" brakes. Induction hardened body.
2210Q7583	S-Cam - 1-1/2" -28 spline for Meritor "Q Plus" brakes	LH	12-13/16"	1-1/2"	16-1/2" brakes.
2210P7582	S-Cam - 1-1/2" -28 spline for Meritor "Q Plus" brakes	RH	12-13/16"	1-1/2"	16-1/2" brakes.
2210U7587	S-Cam - 1-1/2" -28 spline for Meritor "Q Plus" brakes	LH	12-61/64"	1-1/2"	16-1/2" brakes.
2210T7586	S-Cam - 1-1/2" -28 spline for Meritor "Q Plus" brakes	RH	12-61/64"	1-1/2"	16-1/2" brakes.
2210V8394	S-Cam - 1-1/2" -28 spline for Meritor "Q Plus" brakes	LH	12-61/64"	1-5/8"	16-1/2" brakes. LX/MX 500 Series
2210U8393	S-Cam - 1-1/2" -28 spline for Meritor "Q Plus" brakes	RH	12-61/64"	1-5/8"	16-1/2" brakes. LX/MX 500 Series
2210Y7591	S-Cam - 1-1/2" -28 spline for Meritor "Q Plus" brakes	LH	13-3/32"	1-1/2"	16-1/2" brakes.
2210X7590	S-Cam - 1-1/2" -28 spline for Meritor "Q Plus" brakes	RH	13-3/32"	1-1/2"	16-1/2" brakes.
2210C7595	S-Cam - 1-1/2" -28 spline for Meritor "Q Plus" brakes	LH	13-13/64"	1-1/2"	16-1/2" brakes.
2210B7594	S-Cam - 1-1/2" -28 spline for Meritor "Q Plus" brakes	RH	13-13/64"	1-1/2"	16-1/2" brakes.
2210M8333	S-Cam - 1-1/2" -28 spline for Meritor "Q Plus" brakes	LH	13-13/64"	1-5/8"	16-1/2" brakes. LX/MX 500 Series
2210L8332	S-Cam - 1-1/2" -28 spline for Meritor "Q Plus" brakes	RH	13-13/64"	1-5/8"	16-1/2" brakes. LX/MX 500 Series
2210Z7592	S-Cam - 1-1/2" -28 spline for Meritor "Q Plus" brakes	LH	13-19/64"	1-1/2"	15" brakes.
2210A7593	S-Cam - 1-1/2" -28 spline for Meritor "Q Plus" brakes	RH	13-19/64"	1-1/2"	15" brakes.
2210E7597	S-Cam - 1-1/2" -28 spline for Meritor "Q Plus" brakes	LH	13-5/16"	1-1/2"	15" brakes.
2210D7596	S-Cam - 1-1/2" -28 spline for Meritor "Q Plus" brakes	RH	13-5/16"	1-1/2"	15" brakes.
2210L7604	S-Cam - 1-1/2" -28 spline for Meritor "Q Plus" brakes	LH	13-29/64"	1-1/2"	16-1/2" brakes.
2210K7603	S-Cam - 1-1/2" -28 spline for Meritor "Q Plus" brakes	RH	13-29/64"	1-1/2"	16-1/2" brakes.
2210L7838	S-Cam - 1-1/2" -28 spline for Meritor "Q Plus" brakes	LH	13-29/64"	1-1/2"	16-1/2" brakes. Induction hardened body.
2210K7837	S-Cam - 1-1/2" -28 spline for Meritor "Q Plus" brakes	RH	13-29/64"	1-1/2"	16-1/2" brakes. Induction hardened body.
2210X8266	S-Cam - 1-1/2" -28 spline for Meritor "Q Plus" brakes	LH	13-29/64"	1-5/8"	16-1/2" brakes. LX/MX 500 Series
2210W8265	S-Cam - 1-1/2" -28 spline for Meritor "Q Plus" brakes	RH	13-29/64"	1-5/8"	16-1/2" brakes. LX/MX 500 Series
2210Q7609	S-Cam - 1-1/2" -28 spline for Meritor "Q Plus" brakes	LH	13-19/32"	1-1/2"	16-1/2" brakes.
2210P7608	S-Cam - 1-1/2" -28 spline for Meritor "Q Plus" brakes	RH	13-19/32"	1-1/2"	16-1/2" brakes.
2210W7615	S-Cam - 1-1/2" -28 spline for Meritor "Q Plus" brakes	LH	13-45/64"	1-1/2"	16-1/2" brakes.
2210V7614	S-Cam - 1-1/2" -28 spline for Meritor "Q Plus" brakes	RH	13-45/64"	1-1/2"	16-1/2" brakes.
2210A7619	S-Cam - 1-1/2" -28 spline for Meritor "Q Plus" brakes	LH	13-13/16"	1-1/2"	16-1/2" brakes.
2210Z7618	S-Cam - 1-1/2" -28 spline for Meritor "Q Plus" brakes	RH	13-13/16"	1-1/2"	16-1/2" brakes.
2210J7628	S-Cam - 1-1/2" -28 spline for Meritor "Q Plus" brakes	LH	14-3/32"	1-1/2"	16-1/2" brakes.
2210H7626	S-Cam - 1-1/2" -28 spline for Meritor "Q Plus" brakes	RH	14-3/32"	1-1/2"	16-1/2" brakes.
2210S7637	S-Cam - 1-1/2" -28 spline for Meritor "Q Plus" brakes	LH	14-5/16"	1-1/2"	16-1/2" brakes.
2210R7636	S-Cam - 1-1/2" -28 spline for Meritor "Q Plus" brakes	RH	14-5/16"	1-1/2"	16-1/2" brakes.
2210V8342	S-Cam - 1-1/2" -28 spline for Meritor "Q Plus" brakes	LH	14-37/64"	1-5/8"	16-1/2" brakes. LX/MX 500 Series
2210U8341	S-Cam - 1-1/2" -28 spline for Meritor "Q Plus" brakes	RH	14-37/64"	1-5/8"	16-1/2" brakes. LX/MX 500 Series
2210A7645	S-Cam - 1-1/2" -28 spline for Meritor "Q Plus" brakes	LH	14-19/32"	1-1/2"	16-1/2" brakes.
2210Z7644	S-Cam - 1-1/2" -28 spline for Meritor "Q Plus" brakes	RH	14-19/32"	1-1/2"	16-1/2" brakes.

Information & Images Provided by Meritor

Part Number	Description	Head End	Effective Length	Bushing Journal Diameter	Application Information
2210E7649	S-Cam - 1-1/2" -28 spline for Meritor "Q Plus" brakes	LH	14-45/64"	1-1/2"	16-1/2" brakes.
2210D7648	S-Cam - 1-1/2" -28 spline for Meritor "Q Plus" brakes	RH	14-45/64"	1-1/2"	16-1/2" brakes.
2210J7654	S-Cam - 1-1/2" -28 spline for Meritor "Q Plus" brakes	LH	14-13/16"	1-1/2"	16-1/2" brakes.
2210H7652	S-Cam - 1-1/2" -28 spline for Meritor "Q Plus" brakes	RH	14-13/16"	1-1/2"	16-1/2" brakes.
2210Q7661	S-Cam - 1-1/2" -28 spline for Meritor "Q Plus" brakes	LH	14-61/64"	1-1/2"	16-1/2" brakes.
2210P7660	S-Cam - 1-1/2" -28 spline for Meritor "Q Plus" brakes	RH	14-61/64"	1-1/2"	16-1/2" brakes.
2210P8284	S-Cam - 1-1/2" -28 spline for Meritor "Q Plus" brakes	LH	14-61/64"	1-5/8"	16-1/2" brakes. LX/MX 500 Series
2210N8282	S-Cam - 1-1/2" -28 spline for Meritor "Q Plus" brakes	RH	14-61/64"	1-5/8"	16-1/2" brakes. LX/MX 500 Series
2210U7665	S-Cam - 1-1/2" -28 spline for Meritor "Q Plus" brakes	LH	15-3/32"	1-1/2"	16-1/2" brakes.
2210T7664	S-Cam - 1-1/2" -28 spline for Meritor "Q Plus" brakes	RH	15-3/32"	1-1/2"	16-1/2" brakes.
2210W7667	S-Cam - 1-1/2" -28 spline for Meritor "Q Plus" brakes	LH	15-3/32"	1-1/2"	16-1/2" brakes. Induction hardened body.
2210V7666	S-Cam - 1-1/2" -28 spline for Meritor "Q Plus" brakes	RH	15-3/32"	1-1/2"	16-1/2" brakes. Induction hardened body.
2210A7671	S-Cam - 1-1/2" -28 spline for Meritor "Q Plus" brakes	LH	15-13/64"	1-1/2"	16-1/2" brakes.
2210Z7670	S-Cam - 1-1/2" -28 spline for Meritor "Q Plus" brakes	RH	15-13/64"	1-1/2"	16-1/2" brakes.
2210B8218	S-Cam - 1-1/2" -28 spline for Meritor "Q Plus" brakes	LH	15-13/64"	1-5/8"	16-1/2" brakes. LX/MX 500 Series
2210A8217	S-Cam - 1-1/2" -28 spline for Meritor "Q Plus" brakes	RH	15-13/64"	1-5/8"	16-1/2" brakes. LX/MX 500 Series
2210E7675	S-Cam - 1-1/2" -28 spline for Meritor "Q Plus" brakes	LH	15-5/16"	1-1/2"	16-1/2" brakes.
2210D7674	S-Cam - 1-1/2" -28 spline for Meritor "Q Plus" brakes	RH	15-5/16"	1-1/2"	16-1/2" brakes.
2210N7684	S-Cam - 1-1/2" -28 spline for Meritor "Q Plus" brakes	LH	15-19/32"	1-1/2"	16-1/2" brakes.
2210M7683	S-Cam - 1-1/2" -28 spline for Meritor "Q Plus" brakes	RH	15-19/32"	1-1/2"	16-1/2" brakes.
2210S7689	S-Cam - 1-1/2" -28 spline for Meritor "Q Plus" brakes	LH	15-45/64"	1-1/2"	16-1/2" brakes.
2210R7688	S-Cam - 1-1/2" -28 spline for Meritor "Q Plus" brakes	RH	15-45/64"	1-1/2"	16-1/2" brakes.
2210D8220	S-Cam - 1-1/2" -28 spline for Meritor "Q Plus" brakes	LH	15-45/64"	1-5/8"	16-1/2" brakes. LX/MX 500 Series
2210C8219	S-Cam - 1-1/2" -28 spline for Meritor "Q Plus" brakes	RH	15-45/64"	1-5/8"	16-1/2" brakes. LX/MX 500 Series
2210M8177	S-Cam - 1-1/2" -28 spline for Meritor "Q Plus" brakes	LH	15-13/16"	1-5/8"	16-1/2" brakes. LX/MX 500 Series
2210L8176	S-Cam - 1-1/2" -28 spline for Meritor "Q Plus" brakes	RH	15-13/16"	1-5/8"	16-1/2" brakes. LX/MX 500 Series
2210W7693	S-Cam - 1-1/2" -28 spline for Meritor "Q Plus" brakes	LH	15-13/16"	1-1/2"	16-1/2" brakes.
2210V7692	S-Cam - 1-1/2" -28 spline for Meritor "Q Plus" brakes	RH	15-13/16"	1-1/2"	16-1/2" brakes.
2210A7697	S-Cam - 1-1/2" -28 spline for Meritor "Q Plus" brakes	LH	15-61/64"	1-1/2"	16-1/2" brakes.
2210Z7696	S-Cam - 1-1/2" -28 spline for Meritor "Q Plus" brakes	RH	15-61/64"	1-1/2"	16-1/2" brakes.
2210E7701	S-Cam - 1-1/2" -28 spline for Meritor "Q Plus" brakes	LH	16-3/32"	1-1/2"	16-1/2" brakes.
2210D7700	S-Cam - 1-1/2" -28 spline for Meritor "Q Plus" brakes	RH	16-3/32"	1-1/2"	16-1/2" brakes.
2210S7715	S-Cam - 1-1/2" -28 spline for Meritor "Q Plus" brakes	LH	16-29/64"	1-1/2"	16-1/2" brakes.
2210R7714	S-Cam - 1-1/2" -28 spline for Meritor "Q Plus" brakes	RH	16-29/64"	1-1/2"	16-1/2" brakes.
2210W7719	S-Cam - 1-1/2" -28 spline for Meritor "Q Plus" brakes	LH	16-19/32"	1-1/2"	16-1/2" brakes.
2210V7718	S-Cam - 1-1/2" -28 spline for Meritor "Q Plus" brakes	RH	16-19/32"	1-1/2"	16-1/2" brakes.
2210E7727	S-Cam - 1-1/2" -28 spline for Meritor "Q Plus" brakes	LH	16-13/16"	1-1/2"	16-1/2" brakes.
2210D7726	S-Cam - 1-1/2" -28 spline for Meritor "Q Plus" brakes	RH	16-13/16"	1-1/2"	16-1/2" brakes.

Information & Images Provided by Meritor

Part Number	Description	Head End	Effective Length	Bushing Journal Diameter	Application Information
2210J7732	S-Cam - 1-1/2" -28 spline for Meritor "Q Plus" brakes	LH	16-61/64"	1-1/2"	16-1/2" brakes.
2210H7730	S-Cam - 1-1/2" -28 spline for Meritor "Q Plus" brakes	RH	16-61/64"	1-1/2"	16-1/2" brakes.
2210A7749	S-Cam - 1-1/2" -28 spline for Meritor "Q Plus" brakes	LH	17-29/64"	1-1/2"	16-1/2" brakes.
2210Z7748	S-Cam - 1-1/2" -28 spline for Meritor "Q Plus" brakes	RH	17-29/64"	1-1/2"	16-1/2" brakes.
2210S7767	S-Cam - 1-1/2" -28 spline for Meritor "Q Plus" brakes	LH	17-61/64"	1-1/2"	16-1/2" brakes.
2210R7766	S-Cam - 1-1/2" -28 spline for Meritor "Q Plus" brakes	RH	17-61/64"	1-1/2"	16-1/2" brakes.
2210J7784	S-Cam - 1-1/2" -28 spline for Meritor "Q Plus" brakes	LH	18-29/64"	1-1/2"	16-1/2" brakes.
2210H7782	S-Cam - 1-1/2" -28 spline for Meritor "Q Plus" brakes	RH	18-29/64"	1-1/2"	16-1/2" brakes.
2210X8396	S-Cam - 1-1/2" -28 spline for Meritor "Q Plus" brakes	LH	18-29/64"	1-5/8"	16-1/2" brakes. LX/MX 500 Series
2210W8395	S-Cam - 1-1/2" -28 spline for Meritor "Q Plus" brakes	RH	18-29/64"	1-5/8"	16-1/2" brakes. LX/MX 500 Series
2210N7788	S-Cam - 1-1/2" -28 spline for Meritor "Q Plus" brakes	LH	18-19/32"	1-1/2"	16-1/2" brakes.
2210M7787	S-Cam - 1-1/2" -28 spline for Meritor "Q Plus" brakes	RH	18-19/32"	1-1/2"	16-1/2" brakes.
2210F8404	S-Cam - 1-1/2" -28 spline for Meritor "Q Plus" brakes	LH	20-61/64"	1-5/8"	16-1/2" brakes. LX/MX 500 Series
2210E8403	S-Cam - 1-1/2" -28 spline for Meritor "Q Plus" brakes	RH	20-61/64"	1-5/8"	16-1/2" brakes. LX/MX 500 Series

Information & Images Provided by Meritor

MERITOR "Q PLUS" BRAKES WITH TRACKLOCK

Use Camshaft repair kit: KIT8033
Use Brake repair kit: KIT8847HDA

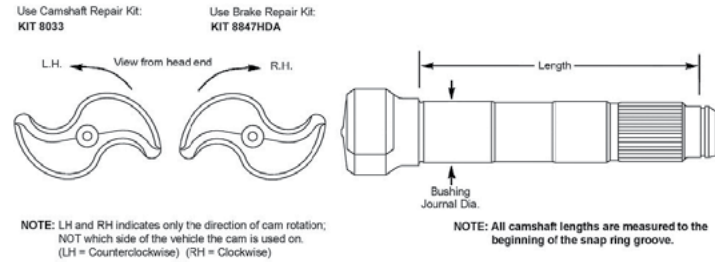


Table 1-61: Meritor "Q Plus" brakes with Traclock

Part Number	Description	Head End	Effective Length	Bushing Journal Diameter	Application Information
2210B8582	S-Cam - 1-1/2" -28 Spline for Meritor "Q Plus" brakes with Traclock	LH	8-29/64"	1-1/2"	15" brakes with TracLok
2210C8583	S-Cam - 1-1/2" -28 Spline for Meritor "Q Plus" brakes with Traclock	RH	8-29/64"	1-1/2"	15" brakes with TracLok
2210M8489	S-Cam - 1-1/2" -28 Spline for Meritor "Q Plus" brakes with Traclock	LH	8-45/64"	1-1/2"	15" brakes with TracLok
2210N8490	S-Cam - 1-1/2" -28 Spline for Meritor "Q Plus" brakes with Traclock	RH	8-45/64"	1-1/2"	15" brakes with TracLok
2210E8351	S-Cam - 1-1/2" -28 Spline for Meritor "Q Plus" brakes with Traclock	LH	9-5/16"	1-1/2"	15" brakes with TracLok
2210F8352	S-Cam - 1-1/2" -28 Spline for Meritor "Q Plus" brakes with Traclock	RH	9-5/16"	1-1/2"	15" brakes with TracLok
2210G8353	S-Cam - 1-1/2" -28 Spline for Meritor "Q Plus" brakes with Traclock	LH	10-13/64"	1-1/2"	15" brakes with TracLok
2210H8354	S-Cam - 1-1/2" -28 Spline for Meritor "Q Plus" brakes with Traclock	RH	10-13/64"	1-1/2"	15" brakes with TracLok

Information & Images Provided by Meritor

CROSS REFERENCE

BRAKE S-CAMS CROSS REFERENCE

Table 1-62: Brake S-Cams Cross Reference

Manufacturer	OE Part Number	Part Number
BATCO		
Batco	04150762	R607127
Batco	04150761	R607128
Batco	04150812	R607129
Batco	04150811	R607130
Batco	04150862	R607133
Batco	04150861	R607134
Batco	04150912	R607143
Batco	2326	1205G761
Batco	2210	1225L1208
Batco	2206	1225R512
Batco	1492	1229D2942
Batco	1472	1229G2971
Batco	4302	1229R122
Batco	4322	1229S2697
Batco	1482	1229X1116
Batco	04461102	2210A7515
Batco	04461161	2210B7542
Batco	04461251	2210B7568
Batco	04461331	2210B7594
Batco	04461162	2210C7543
Batco	04461252	2210C7569
Batco	04461332	2210C7595
Batco	04481041	2210D7492
Batco	04481042	2210E7493
Batco	04460921	2210F7442
Batco	04460922	2210G7443
Batco	04481121	2210H7522
Batco	04461421	2210H7626
Batco	4461421	2210H7626
Batco	04481471	2210H7652
Batco	04481122	2210J7524
Batco	04461722	2210J7628

Batco	4461422	2210J7628
Batco	04481472	2210J7654
Batco	04480771	2210K7395
Batco	04481051	2210K7499
Batco	04481211	2210K7551
Batco	04481341	2210K7603
Batco	04481351	2210K7837
Batco	04480772	2210L7396
Batco	04481052	2210L7500
Batco	04481212	2210L7552
Batco	04481342	2210L7604
Batco	04481352	2210L7838
Batco	04460851	2210P7426
Batco	4460851	2210P7426
Batco	04460852	2210Q7427
Batco	4460852	2210Q7427
Batco	04460951	2210T7456
Batco	04461311	2210T7586
Batco	04452522	2210U4909
Batco	04460952	2210U7457
Batco	04461312	2210U7587
Batco	04450521	2210V4910
Batco	4461151	2210V7536
Batco	04481152	2210W7537
Batco	4461152	2210W7537
Batco	04460821	2210X7408
Batco	04460822	2210Y7409
Batco	04461101	2210Z7514
Batco	2300	A1205V1556
Batco	2356	A1205V1556
Batco	81318	K1T8042
Batco	04371151	R607015
Batco	4265	R607015
Batco	04371152	R607016
Batco	4264	R607016
Batco	04451031	R607017
Batco	4156	R607017
Batco	04451032	R607018
Batco	4157	R607018
Batco	04371251	R607029

Batco	4268	R607029
Batco	04371252	R607030
Batco	4269	R607030
Batco	04370861	R607035
Batco	4266	R607035
Batco	04370862	R607036
Batco	4267	R607036
Batco	04391162	R607105
Batco	04391161	R607106
Batco	04390862	R607111
Batco	04390861	R607112
Batco	04160932	R607117
Batco	04160931	R607118
Batco	04160962	R607119
Batco	04160961	R607120
Batco	04160812	R607121
Batco	04160811	R607122
Batco	04161002	R607123
Batco	04161001	R607124
Batco	04371312	R607125
Batco	04371311	R607126
Batco	04150962	R607131
Batco	04150961	R607132
Batco	04151112	R607135
Batco	04151111	R607136
Batco	04150932	R607137
Batco	04150931	R607138
Batco	04151002	R607139
Batco	04151001	R607140
Batco	04150911	R607144
Batco	04371022	R607147
Batco	04371021	R607148
Batco	04371122	R607149
Batco	04371121	R607150
Batco	04391052	R607151
Batco	04391051	R607152
Batco	04391252	R607153
Batco	04391251	R607154
Batco	04391442	R607155

Batco	04391441	R607156
Batco	81351	R615002
Batco	4307	R627005
Batco	4308	R627006
Batco	2304	R627008
Batco	4319	R627012

BWP

BWP	M1095	1205G761
BWP	M571	1225L1208
BWP	M1551	1225R512
BWP	M1586	1225R512
BWP	M748	1229G2971
BWP	M583	1229R122
BWP	M2638	1229S2697
BWP	M1523	1229X1116
BWP	M2633	A1205V1556
BWP	M587A	A1205V1556
BWP	M1571R	R607015
BWP	M1571L	R607016
BWP	M778R	R607017
BWP	M778L	R607018
BWP	M2616R	R607029
BWP	M2616L	R607030
BWP	M2615R	R607035
BWP	M2615L	R607036
BWP	MK19	R615002
BWP	M1408	R627005
BWP	M1409	R627006
BWP	M824A	R627008
BWP	M2649	R627012
BWP	M824	R627018

CR

CR	542671	A1205V1556
CR	544048	A1205V1556

DANA

Dana	271203	1205G761
Dana	301375	1205G761
Dana	281233	1225L1208
Dana	281234	1225R512

Dana	341547	1229D2942
Dana	351580	1229G2971
Dana	291307	1229R122
Dana	341525	1229X1116
Dana	291270	A1205V1556
Dana	291281	A1205V1556
Dana	18738	R607015
Dana	18739	R607016
Dana	437041	R615002
Dana	291321	R627005
Dana	291320	R627006
Dana	291266	R627008
Dana	291303	R627012

EATON

Eaton	1006724	R607127
Eaton	1006725	R607128
Eaton	1006726	R607129
Eaton	1006727	R607130
Eaton	1006948	R607141
Eaton	1006949	R607142
Eaton	1006730	R607133
Eaton	1006731	R607134
Eaton	1008006	R607143
Eaton	32149	1225L1208
Eaton	32144	1229D2942
Eaton	32181	1229R122
Eaton	22137	1229X1116
Eaton	32165	A1205V1556
Eaton	62253	K1T8042
Eaton	70307	R607015
Eaton	72395	R607015
Eaton	70306	R607016
Eaton	72396	R607016
Eaton	820108	R607017
Eaton	B17352	R607017
Eaton	820102	R607018
Eaton	B17351	R607018
Eaton	71307	R607029

Eaton	72399	R607029
Eaton	71306	R607030
Eaton	72400	R607030
Eaton	1000088	R607035
Eaton	72389	R607035
Eaton	1000087	R607036
Eaton	72390	R607036
Eaton	806526	R607105
Eaton	806527	R607106
Eaton	808708	R607111
Eaton	808709	R607112
Eaton	813480	R607117
Eaton	813481	R607118
Eaton	813482	R607119
Eaton	813483	R607120
Eaton	813486	R607121
Eaton	813487	R607122
Eaton	813494	R607123
Eaton	813495	R607124
Eaton	1000839	R607125
Eaton	1000840	R607126
Eaton	1006728	R607131
Eaton	1006729	R607132
Eaton	1006864	R607135
Eaton	1006865	R607136
Eaton	1006866	R607137
Eaton	1006867	R607138
Eaton	1006940	R607139
Eaton	1006941	R607140
Eaton	1008007	R607144
Eaton	40547	R607147
Eaton	40548	R607148
Eaton	45530	R607149
Eaton	76293	R607149
Eaton	45531	R607150
Eaton	76294	R607150
Eaton	807858	R607151
Eaton	808072	R607151
Eaton	807859	R607152

Eaton	808073	R607152
Eaton	808290	R607153
Eaton	808291	R607154
Eaton	807862	R607155
Eaton	807863	R607156
Eaton	32172	R627018

EUCLID

Euclid	E5058	R607127
Euclid	E5059	R607128
Euclid	E5129	R607129
Euclid	E5130	R607130
Euclid	E5064	R607141
Euclid	E5065	R607142
Euclid	E5060	R607133
Euclid	E5061	R607134
Euclid	E5066	R607143
Euclid	E3859	1205G761
Euclid	E536	1225L1208
Euclid	E5512	1225L1208
Euclid	E667	1225R512
Euclid	E5093	1229D2942
Euclid	E669	1229D2942
Euclid	E1113	1229G2971
Euclid	E5095	1229J3130
Euclid	E580	1229R122
Euclid	E3479	1229S2697
Euclid	E801	1229X1116
Euclid	E654	A1205V1556
Euclid	E3993	K1T8042
Euclid	E3993B	K1T8042
Euclid	E1775	R607015
Euclid	E1776	R607016
Euclid	E1788	R607017
Euclid	E1789	R607018
Euclid	E2786	R607029
Euclid	E2787	R607030
Euclid	E2799	R607035
Euclid	E2800	R607036
Euclid	E5492	R607105

Euclid	E5493	R607106
Euclid	E5490	R607111
Euclid	E5491	R607112
Euclid	E9030	R607117
Euclid	E9031	R607118
Euclid	E9032	R607119
Euclid	E9033	R607120
Euclid	E9028	R607121
Euclid	E9029	R607122
Euclid	E9034	R607123
Euclid	E9035	R607124
Euclid	E4888	R607125
Euclid	E4889	R607126
Euclid	E5133	R607131
Euclid	E5134	R607132
Euclid	E5062	R607135
Euclid	E5063	R607136
Euclid	E5131	R607137
Euclid	E5132	R607138
Euclid	E5135	R607139
Euclid	E5136	R607140
Euclid	E5067	R607144
Euclid	E9763	R607147
Euclid	E9764	R607148
Euclid	E9765	R607149
Euclid	E9766	R607150
Euclid	E9767	R607151
Euclid	E9768	R607152
Euclid	E9769	R607153
Euclid	E9770	R607154
Euclid	E9771	R607155
Euclid	E9772	R607156
Euclid	E2125	R615002
Euclid	E1782	R627005
Euclid	E1781	R627006
Euclid	E1416A	R627008
Euclid	E3234	R627012
Euclid	E1416	R627018

LELAND

Leland	L2835	R607129
Leland	L2834	R607130
Leland	L1662	1205G761
Leland	L330	1225R512
Leland	L331	1229D2942
Leland	L193	1229R122
Leland	L2928	1229S2697
Leland	L397	1229X1116
Leland	L1726	A1205V1556
Leland	L329	A1205V1556
Leland	L1202	R607015
Leland	L1203	R607016
Leland	L1072	R607017
Leland	L1073	R607018
Leland	L1619	R607029
Leland	L1620	R607030
Leland	L1631	R607035
Leland	L1632	R607036
Leland	L2975	R607105
Leland	L2974	R607106
Leland	L2971	R607111
Leland	L2970	R607112
Leland	L2483	R607125
Leland	L2482	R607126
Leland	L2839	R607131
Leland	L2838	R607132
Leland	L2837	R607139
Leland	L2836	R607140
Leland	L2489	R607147
Leland	L2488	R607148
Leland	L2485	R607149
Leland	L2484	R607150
Leland	L3077	R607151
Leland	L3076	R607152
Leland	L2977	R607153
Leland	L2976	R607154
Leland	K80	R615002
Leland	L1609	R627005
Leland	L1608	R627006
Leland	L966	R627008

Leland	L1606	R627012
Leland	L1770	R627018

MIDLAND

Midland	65329	1225L1208
Midland	65441	1225R512
Midland	65373	1229G2971
Midland	65339	1229R122
Midland	66699	1229S2697
Midland	65358	1229X1116
Midland	65352	A1205V1556
Midland	66563	A1205V1556
Midland	41761	R607015
Midland	41760	R607016
Midland	41011	R607017
Midland	41010	R607018
Midland	41043	R607029
Midland	41042	R607030
Midland	41027	R607035
Midland	41026	R607036
Midland	67326(2)	R615002
Midland	67375	R627005
Midland	67374	R627006
Midland	65383	R627018

NAVISTAR

Navistar	385958C1	R607015
Navistar	385957C1	R607016

ROCKWELL

Rockwell	2210Z5434	2210A7515
Rockwell	2210F5492(S)	2210A7619
Rockwell	2210L5446(S)	2210A7645
Rockwell	2210N5344(S)	2210A7645
Rockwell	2210L5784(S)	2210A7671
Rockwell	2210X6680(S)	2210A7697
Rockwell	2210G5935(S)	2210A7749
Rockwell	2210U7067	2210A7749
Rockwell	2210E6687(S)	2210B7412
Rockwell	2210Y5823(S)	2210B7412
Rockwell	2210N6020(S)	2210B7464
Rockwell	2210G5415(S)	2210B7542

Rockwell	2210W5327(S)	2210B7568
Rockwell	2210C5333(S)	2210B7594
Rockwell	2210F6688(S)	2210C7413
Rockwell	2210Z5824(S)	2210C7413
Rockwell	2210P6022(S)	2210C7465
Rockwell	2210H5416(S)	2210C7543
Rockwell	2210X5328(S)	2210C7569
Rockwell	2210D5334(S)	2210C7595
Rockwell	2210C6451	2210D7492
Rockwell	2210E5361(S)	2210D7492
Rockwell	2210Q5425(S)	2210D7648
Rockwell	2210R7948	2210D7648
Rockwell	2210M5785(S)	2210D7674
Rockwell	2210M5499(S)	2210D7700
Rockwell	2210T6988	2210D7726
Rockwell	2210U5559(S)	2210D7726
Rockwell	2210D6452	2210E7493
Rockwell	2210F5362(S)	2210E7493
Rockwell	2210R5426(S)	2210E7649
Rockwell	2210S7949	2210E7649
Rockwell	2210N5786(S)	2210E7675
Rockwell	2210N5500(S)	2210E7701
Rockwell	2210U6989	2210E7727
Rockwell	2210V5560(S)	2210E7727
Rockwell	2210C6009(S)	2210F7416
Rockwell	2210U5455(S)	2210F7442
Rockwell	2210Y5459(S)	2210F7468
Rockwell	2210P6490(S)	2210F7546
Rockwell	2210D6010(S)	2210G7417
Rockwell	2210V5456(S)	2210G7443
Rockwell	2210Z5460(S)	2210G7469
Rockwell	2210Q6491(S)	2210G7547
Rockwell	2210C6035(S)	2210H7522
Rockwell	2210S5323(S)	2210H7522
Rockwell	2210U5325(S)	2210H7522
Rockwell	2210M5369(S)	2210H7626
Rockwell	2210D5932	2210H7652
Rockwell	2210Y5485(S)	2210H7730
Rockwell	2210D6036(S)	2210J7524

Rockwell	2210T5324(S)	2210J7524
Rockwell	2210V5326(S)	2210J7524
Rockwell	2210N5370(S)	2210J7628
Rockwell	2210E5933	2210J7654
Rockwell	2210Z5486(S)	2210J7732
Rockwell	2210U6105(S)	2210K7343
Rockwell	2210N5838(S)	2210K7395
Rockwell	2210S6649(S)	2210K7473
Rockwell	2210W5847(S)	2210K7473
Rockwell	2210S5505(S)	2210K7499
Rockwell	2210G6663	2210K7551
Rockwell	2210K7213	2210K7551
Rockwell	2210G5441(S)	2210K7603
Rockwell	2210M5395(S)	2210K7837
Rockwell	2210V6106(S)	2210L7344
Rockwell	2210P5840(S)	2210L7396
Rockwell	2210T6650(S)	2210L7474
Rockwell	2210X5848(S)	2210L7474
Rockwell	2210T5506(S)	2210L7500
Rockwell	2210H6664	2210L7552
Rockwell	2210L7214	2210L7552
Rockwell	2210H5442(S)	2210L7604
Rockwell	2210N5396(S)	2210L7838
Rockwell	2210Q6153(S)	2210M7501
Rockwell	2210Q5503	2210M7683
Rockwell	2210G5467(S)	2210M7787
Rockwell	2210R6154(S)	2210N7502
Rockwell	2210R5504	2210N7684
Rockwell	2210H5468(S)	2210N7788
Rockwell	2210Q5477(S)	2210P7374
Rockwell	2210E5439(S)	2210P7426
Rockwell	2210Q5373(S)	2210P7452
Rockwell	2210E6557	2210P7478
Rockwell	2210U5429(S)	2210P7478
Rockwell	2210G5363(S)	2210P7582
Rockwell	2210W5431(S)	2210P7608
Rockwell	2210Q5451(S)	2210P7660
Rockwell	2210A6449	2210P7842
Rockwell	2210R5478(S)	2210Q7375

Rockwell	2210F5440(S)	2210Q7427
Rockwell	2210R5374(S)	2210Q7453
Rockwell	2210F6558	2210Q7479
Rockwell	2210V5430(S)	2210Q7479
Rockwell	2210H5364(S)	2210Q7583
Rockwell	2210X5432(S)	2210Q7609
Rockwell	2210R5452(S)	2210Q7661
Rockwell	2210B6450	2210Q7843
Rockwell	2210W5977(S)	2210R7636
Rockwell	2210C5671	2210R7688
Rockwell	2210K5393(S)	2210R7688
Rockwell	2210Q5945	2210R7714
Rockwell	2210V6990	2210R7714
Rockwell	2210Z6188(S)	2210R7766
Rockwell	2210J6510(S)	2210R7844
Rockwell	2210X5978(S)	2210S7637
Rockwell	2210D5672	2210S7689
Rockwell	2210L5394(S)	2210S7689
Rockwell	2210R5946	2210S7715
Rockwell	2210W6991	2210S7715
Rockwell	2210A6189(S)	2210S7767
Rockwell	2210K6511(S)	2210S7845
Rockwell	2210E6011	2210T7430
Rockwell	2210N5968(S)	2210T7430
Rockwell	2210S5427(S)	2210T7456
Rockwell	2210J5990(S)	2210T7560
Rockwell	2210K5341(S)	2210T7586
Rockwell	2210E5465(S)	2210T7664
Rockwell	2210F6012	2210U7431
Rockwell	2210P5970(S)	2210U7431
Rockwell	2210T5428(S)	2210U7457
Rockwell	2210K5991(S)	2210U7561
Rockwell	2210L5342(S)	2210U7587
Rockwell	2210F5466(S)	2210U7665
Rockwell	2210C6607	2210V7484
Rockwell	2210C5437(S)	2210V7510
Rockwell	2210A5331(S)	2210V7536
Rockwell	2210L5836(S)	2210V7614
Rockwell	2210S5453(S)	2210V7614

Rockwell	2210M5447(S)	2210V7718
Rockwell	2210D6608	2210W7485
Rockwell	2210D5438(S)	2210W7511
Rockwell	2210B5332(S)	2210W7537
Rockwell	2210M5837(S)	2210W7615
Rockwell	2210T5454(S)	2210W7615
Rockwell	2210N5448(S)	2210W7719
Rockwell	2210G5337(S)	2210X7408
Rockwell	2210W6159(S)	2210X7564
Rockwell	2210S6025(S)	2210X7590
Rockwell	2210H5338(S)	2210Y7409
Rockwell	2210X6160(S)	2210Y7565
Rockwell	2210T6026(S)	2210Y7591
Rockwell	2210Y5433	2210Z7514
Rockwell	2210E5491(S)	2210Z7618
Rockwell	2210K5445(S)	2210Z7644
Rockwell	2210M5343(S)	2210Z7644
Rockwell	2210K5783(S)	2210Z7670
Rockwell	2210W6679(S)	2210Z7696
Rockwell	2210F5934(S)	2210Z7748
Rockwell	2210T7066	2210Z7748

SIRCO

Sirco	B8690	1205G761
Sirco	B8960	1205G761
Sirco	B8600A	1225L1208
Sirco	B8689	1229D2942
Sirco	B8607	1229R122
Sirco	B8719	1229S2697
Sirco	B793	1229X1116
Sirco	C350R	2210H7522
Sirco	C359L	2210J7524
Sirco	B8609	A1205V1556
Sirco	B8707	K1T8042
Sirco	C775R	R607015
Sirco	C776L	R607016
Sirco	C790L	R607035
Sirco	C799R	R607036
Sirco	B8648	R615002
Sirco	B8629	R627005

Sirco	B8630	R627006
Sirco	B8612A	R627008
Sirco	B8722	R627012
Sirco	B8612	R627018

SPICER

Spicer	291269	R627018
--------	--------	---------

TRANSIT

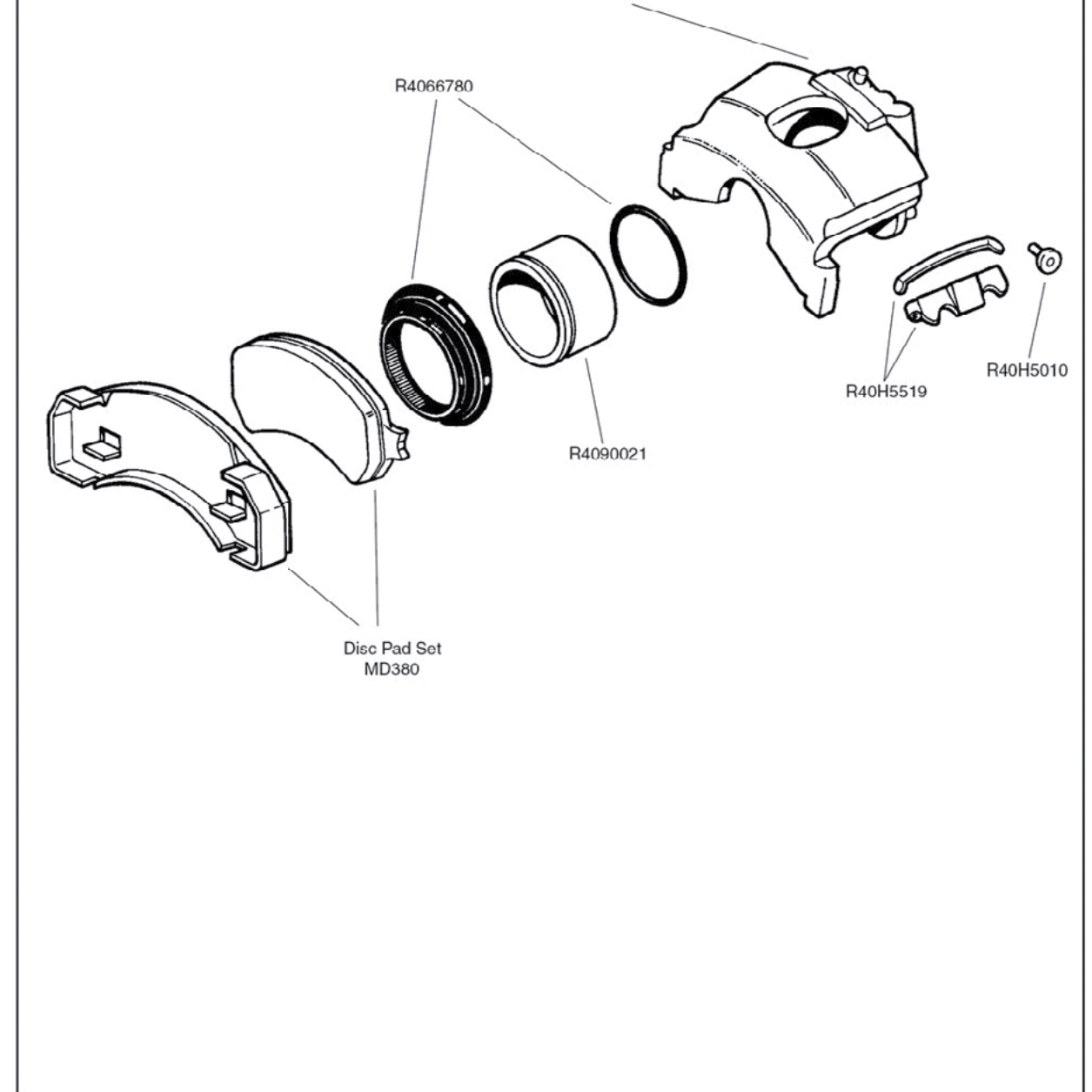
Transit	TP483	1225L1208
Transit	TP579	1225R512
Transit	TP1159	1229G2971
Transit	TP477	1229R122
Transit	TP681	1229X1116
Transit	TP582	A1205V1556
Transit	TP1593	R607015
Transit	TP1594	R607016
Transit	TP1568	R607017
Transit	TP1567	R607018
Transit	TP1959	R607029
Transit	TP1960	R607030
Transit	TP1957	R607035
Transit	TP1958	R607036
Transit	TP1640	R615002
Transit	TP1595	R627006
Transit	TP1474	R627008
Transit	TP8429	R627012
Transit	TP1748	R627018

BENDIX HYDRAULIC DISC BRAKE

(3.38" Single Piston)

FMSI 7108-D184
7806-D184
7815-D184
7815-D380
7815-D717

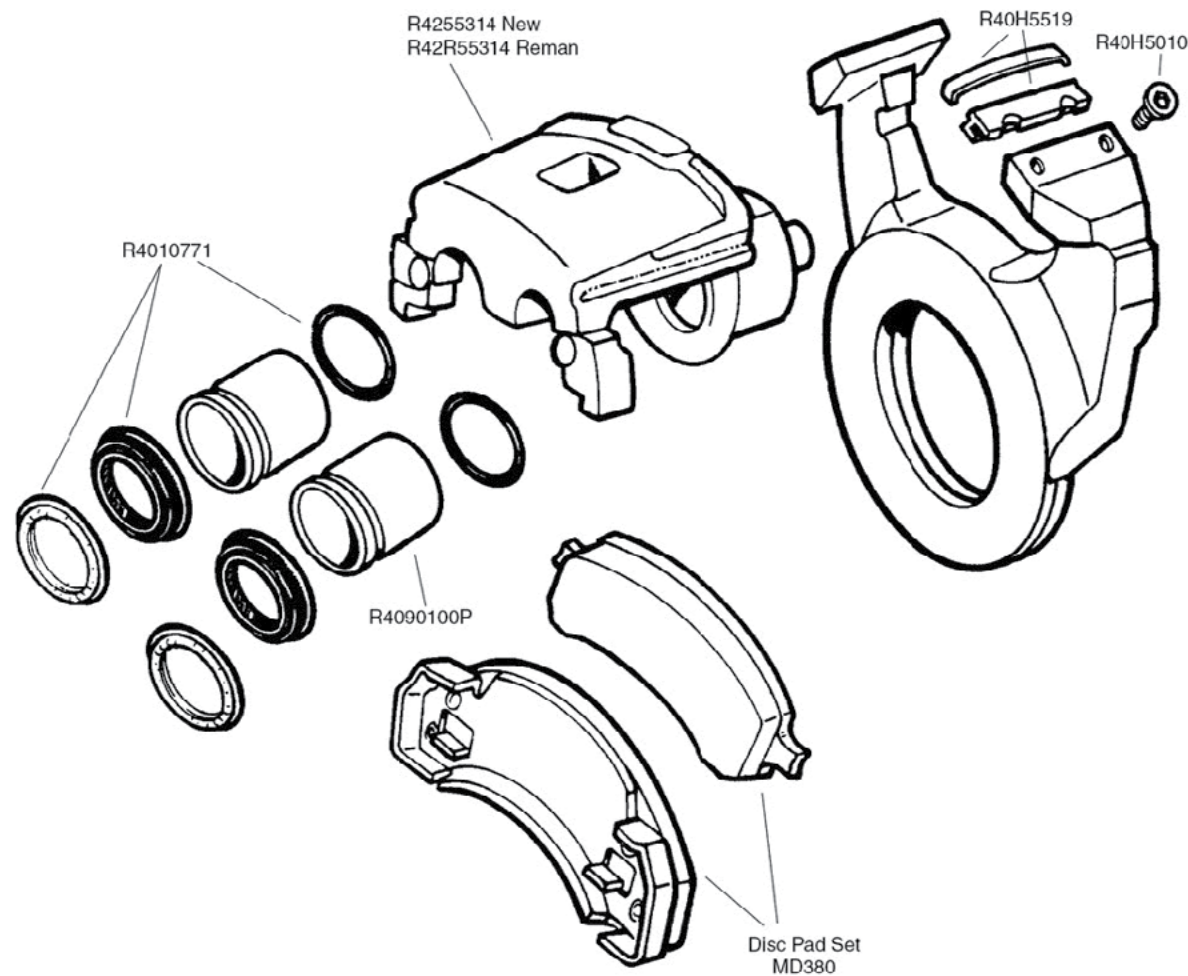
R4255098 (RH) New
 R4255099 (LH) New
 R42R55098 (RH) Reman
 R42R55099 (LH) Reman



BENDIX HYDRAULIC DISC BRAKE

(2.60" Twin Piston)
SECOND DESIGN
(Effective with Model Year 1989)

FMSI 7108-D184
7806-D184
7815-D184
7815-D380
7815-D717

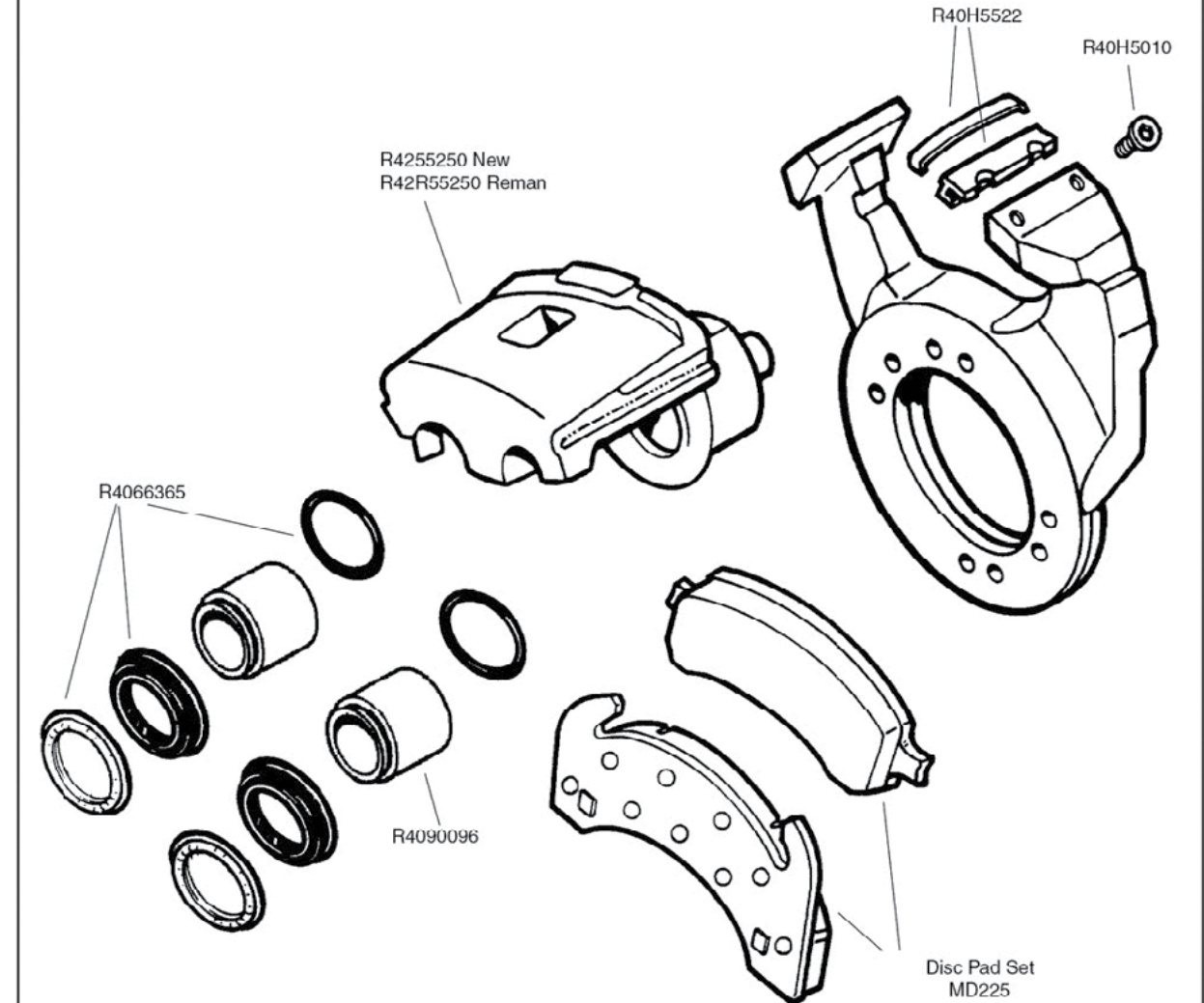


NOTE:
The First Design Caliper (R42R55245) and Second Design Caliper (R4255314, R42R55314) are interchangeable as assemblies, but their component parts are not.

BENDIX HYDRAULIC DISC BRAKE

(2.88" Twin Piston)
SECOND DESIGN
(Effective with Model Year 1988 ITEC and GM Medium-Duty Trucks)

FMSI 7142-D225
(Optional 7808-D225)

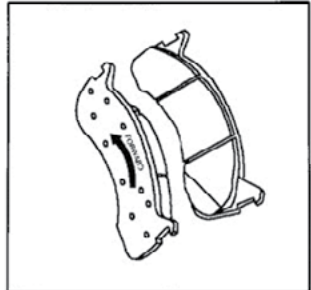
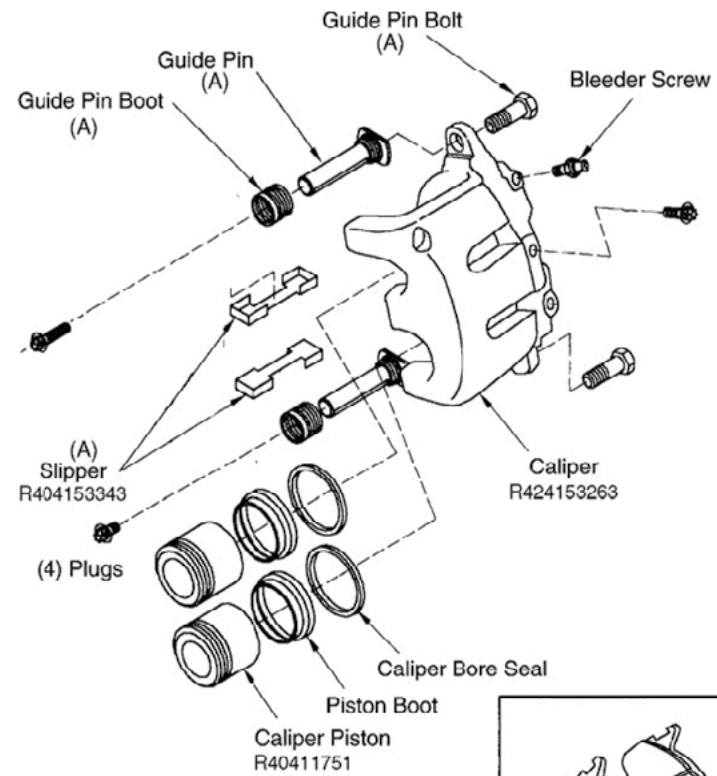


NOTE:
Freightliner with Air Suspension
R4255656

NOTE:
The First and Second Design Caliper are interchangeable as assemblies, but their component parts are not.

BOSCH HYDRAULIC DISC BRAKE

Pin Slide Disc Brake Components
(66MM)

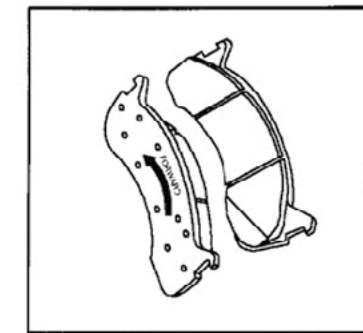
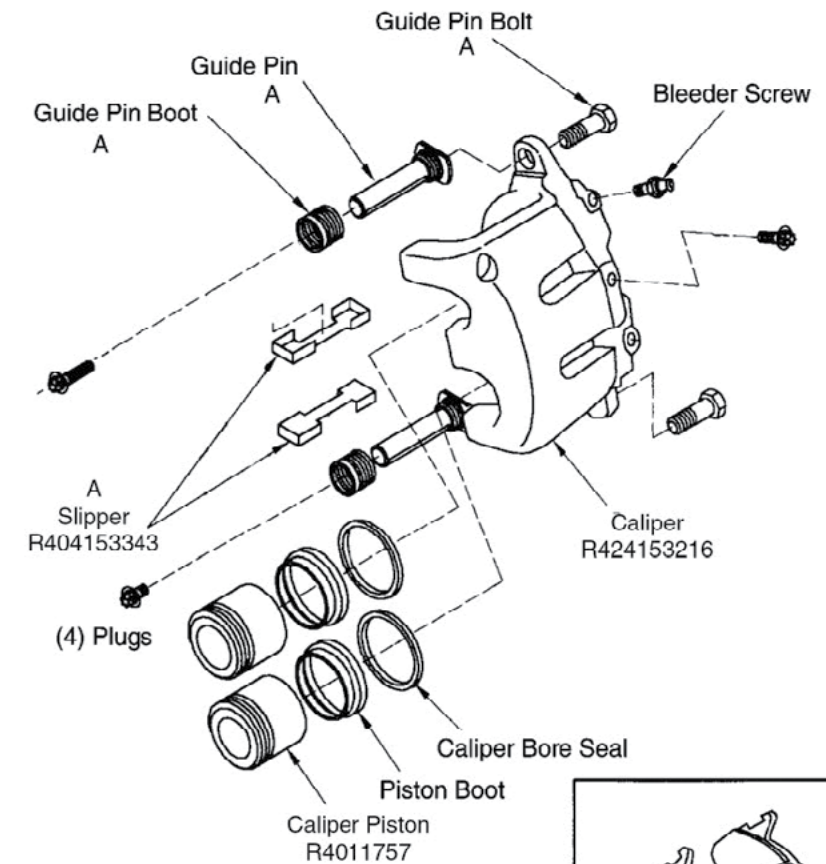


BRAKE PADS
MD786A

A	Contained in Guide Pin Kit R4011754
---	-------------------------------------

BOSCH HYDRAULIC DISC BRAKE

Pin Slide Disc Brake Components
(73MM)



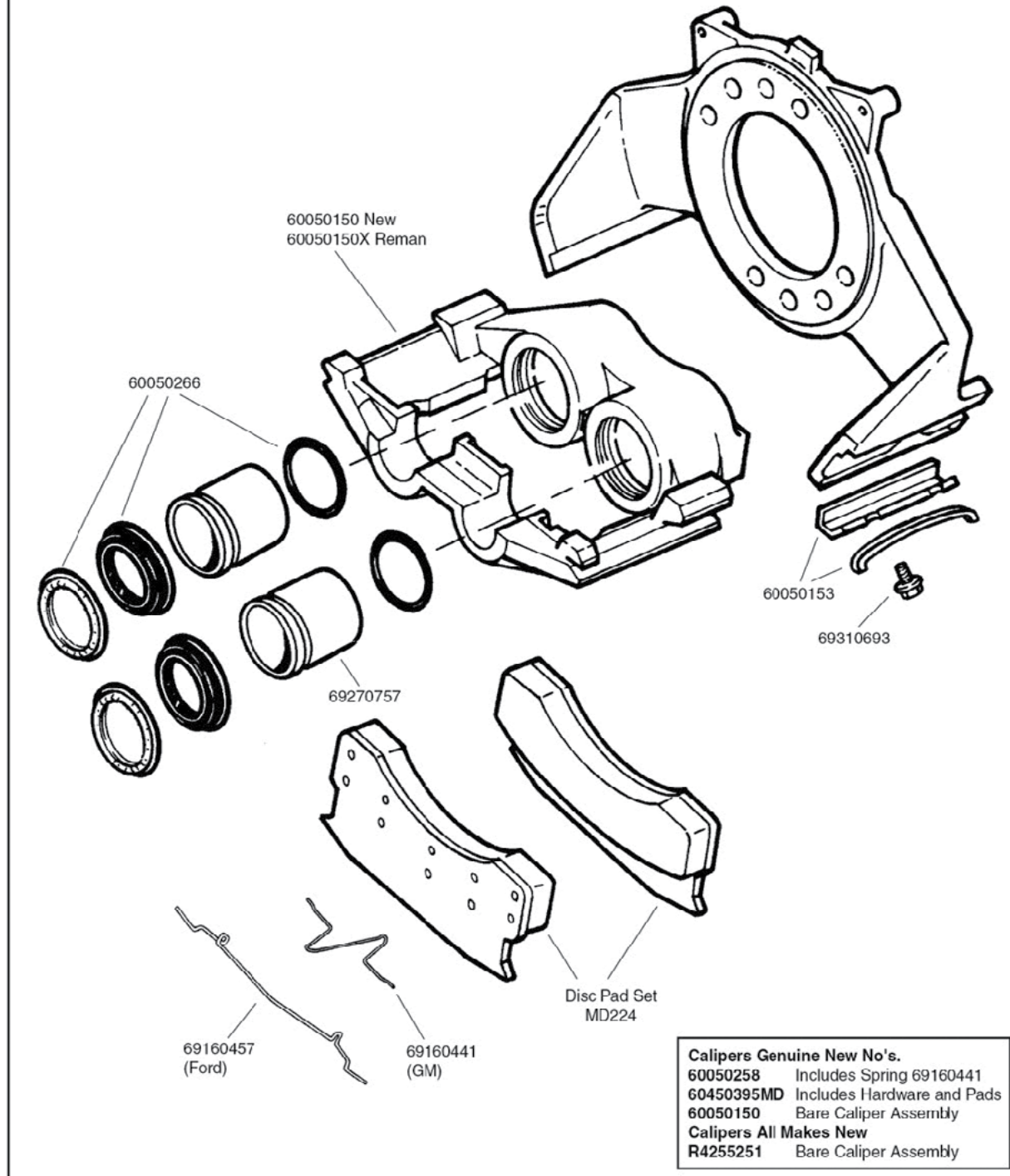
BRAKE PADS
MD786A

A	Contained in Guide Pin Kit R4011754
---	-------------------------------------

MERITOR HYDRAULIC DISC BRAKE

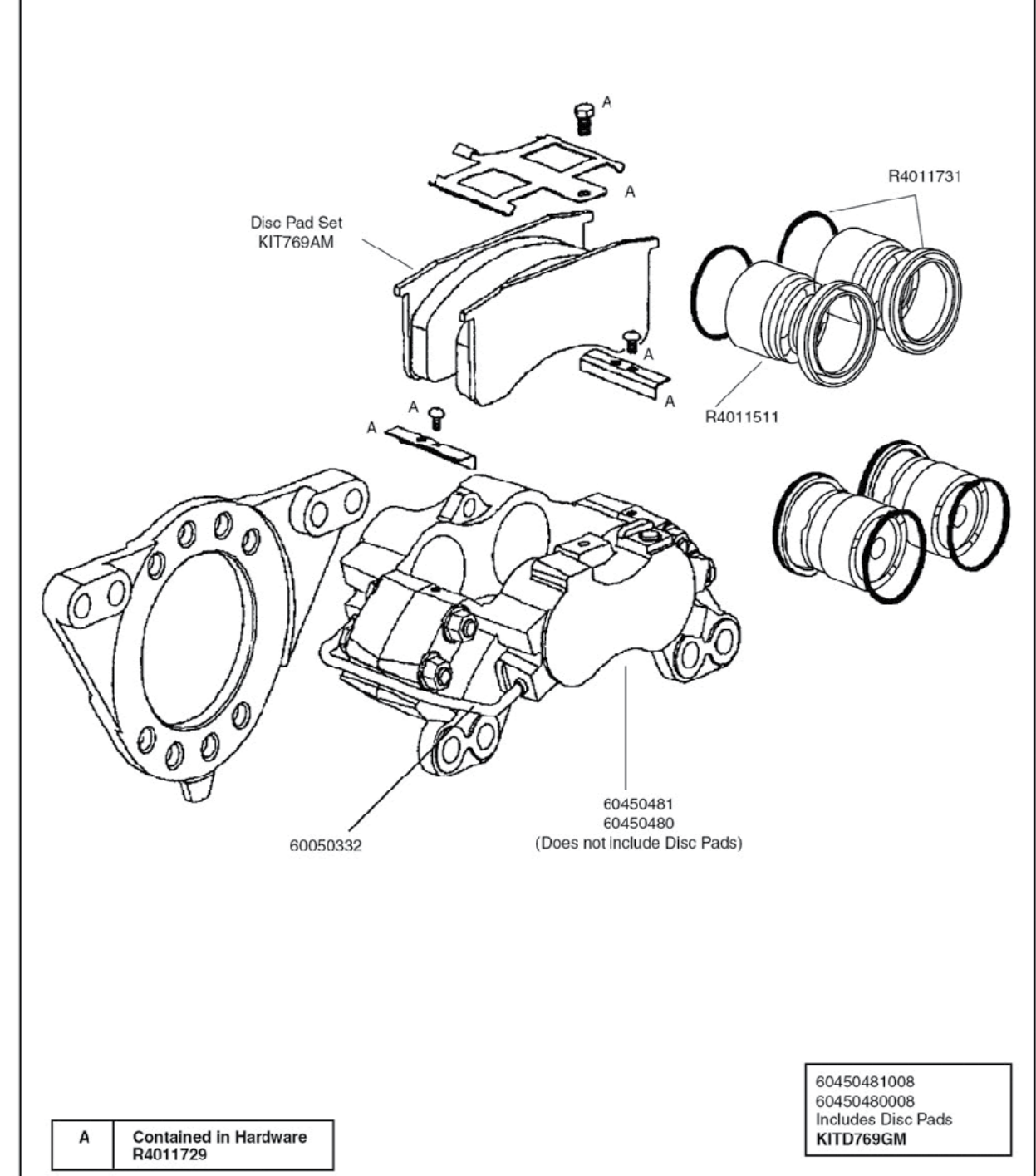
(2.50" Twin Piston)

FMSI 7141-D224
(Optional 7807-D224)

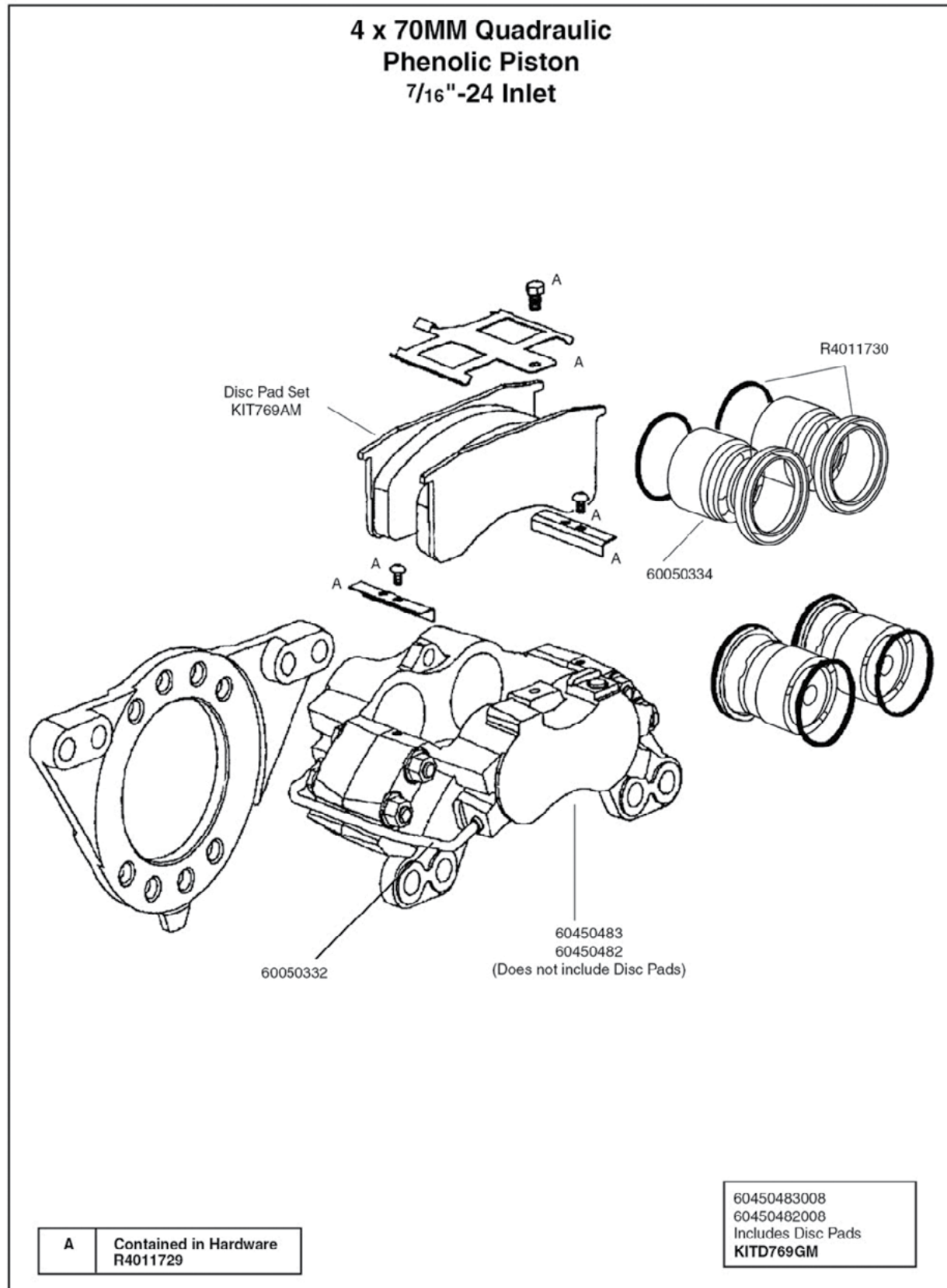


MERITOR HYDRAULIC DISC BRAKE

4 x 64MM Quadraulic
Phenolic Piston
7/16"-24 Inlet



MERITOR HYDRAULIC DISC BRAKE





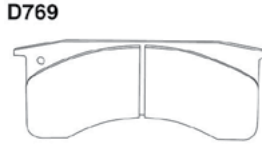
HYDRAULIC BRAKES & BRAKE PARTS

Table 1-63: Meritor Hydraulic Brakes




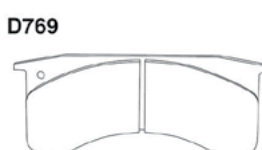
Product	Part Number	Description	Replaces
MERITOR HYDRAULIC DISC BRAKE PARTS - 2.50" TWIN PISTON			
	R40H5519	Hardware Kit (for 1 wheel) for Meritor Hydraulic Disc Brakes - 2.50" Twin Piston	Ford E4HZ-28487A Ford E4H2-28552A GM 15501147 Meritor 69-420654 Meritor 69-69160383
No Image Available	R4066780	Boot & Seal Kit for Meritor Hydraulic Disc Brakes - 2.50" Twin Piston	Ford E4HZ-2207A GM 15510025 Meritor 60-50151
	R40HS010	Guide Bolt for Meritor Hydraulic Disc Brakes - 2.50" Twin Piston	Carlson H5037 (For Use With 60050153 Kit)
	69160457	Disc Pad Retainer Clip - Ford - for Meritor Hydraulic Disc Brakes - 2.50" Twin Piston	n/a
	69160441	Disc Pad Retainer Clip - GM - for Meritor Hydraulic Disc Brakes - 2.50" Twin Piston	Meritor 69-160441B
	69270757	Caliper Piston - 2.50" Diam. Aluminum for Meritor Hydraulic Disc Brakes - 2.50" Twin Piston	Meritor 69-270757
	MD224	D224 - Inner & Outer brake pads for Meritor Hydraulic Disc Brakes - 2.50" Twin Piston	Meritor 69-240767
	MMD224	D224 - Inner & Outer brake pads for Meritor Hydraulic Disc Brakes - 2.50" Twin Piston	Meritor 69-240767
	MVD224	D224 - Inner & Outer brake pads for Meritor Hydraulic Disc Brakes - 2.50" Twin Piston	Meritor 69-240767
MERITOR HYDRAULIC DISC BRAKE PARTS - 4 x 64MM QUADRAULIC PHENOLIC PISTON (7/16" - 24 INLET)			
	R4011729	Hardware Kit (for 1 wheel) for Meritor Hydraulic Disc Brakes - 4 x 64mm	Meritor 69160483 - 1 Anti-Rattle Spring Meritor 69310818 - 1 Bolt Meritor 69330709 - 2 Lining Spacers Meritor 69310819 - 2 Lining Spacer Bolts

MD = Standard Pads
MVD = Value Pads
MMD = Frequent Stop Pads

Information & Images Provided by Meritor

Product	Part Number	Description	Replaces
	R4011731	Boot & Seal Kit for Meritor Hydraulic Disc Brakes - 4 x 64mm	Meritor 69170043 (Seal) Meritor 69340647 (Boot)
	R4011511	Caliper Piston - 64mm Diam. Aluminum for Meritor Hydraulic Disc Brakes - 4 x 64mm	Meritor 69260551 (Piston) Meritor 69330719 (Heat Shield)
	K1TD769AM	D769 - Inner & Outer brake pads for Meritor Hydraulic Disc Brakes - 4 x 64mm	FMSI 7636
	K1TD769GM	D769 - Inner & Outer brake pads for Meritor Hydraulic Disc Brakes - 4 x 64mm	FMSI 7636
	MD769	D769 - Inner & Outer brake pads for Meritor Hydraulic Disc Brakes - 4 x 64mm	FMSI 7636
	MVD769	D769 - Inner & Outer brake pads for Meritor Hydraulic Disc Brakes - 4 x 64mm	FMSI 7636
	MMD769	D769 - Inner & Outer brake pads for Meritor Hydraulic Disc Brakes - 4 x 64mm	FMSI 7636

MERITOR HYDRAULIC DISC BRAKE PARTS - 4 x 70MM QUADRAULIC PHENOLIC PISTON (7/16" - 24 INLET)

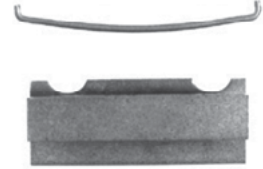


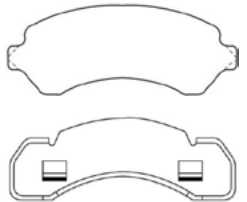

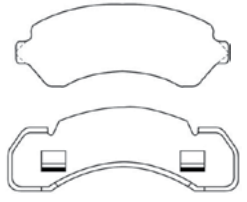
	R4011729	Hardware Kit (for 1 wheel) for Meritor Hydraulic Disc Brakes - 4 x 70mm	Meritor 69160483 - 1 Anti-Rattle Spring Meritor 69310818 - 1 Bolt Meritor 69330709 - 2 Lining Spacers Meritor 69310814 - 2 Lining Spacer Bolts
	R4011730	Boot & Seal Kit for Meritor Hydraulic Disc Brakes - 4 x 70mm	Meritor 69340646 - 4 Seals Meritor 69170337 - 4 Boots
	60050334	Caliper Piston - 70mm Diam. Phenolic for Meritor Hydraulic Disc Brakes - 4 x 70mm	Meritor 60050334 or 69260549 (Piston)
	K1TD769AM	D769 - Inner & Outer brake pads for Meritor Hydraulic Disc Brakes - 4 x 70mm	FMSI 7636
	K1TD769GM	D769 - Inner & Outer brake pads for Meritor Hydraulic Disc Brakes - 4 x 70mm	FMSI 7636
	MD769	D769 - Inner & Outer brake pads for Meritor Hydraulic Disc Brakes - 4 x 70mm	FMSI 7636
	MVD769	D769 - Inner & Outer brake pads for Meritor Hydraulic Disc Brakes - 4 x 70mm	FMSI 7636
	MMD769	D769 - Inner & Outer brake pads for Meritor Hydraulic Disc Brakes - 4 x 70mm	FMSI 7636

MD = Standard Pads
MVD = Value Pads
MMD = Frequent Stop Pads

Information & Images Provided by Meritor

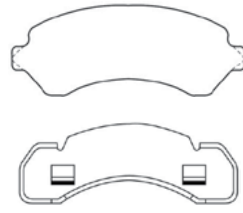


Table 1-64: Bendix Hydraulic Brakes

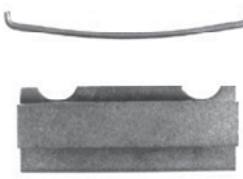
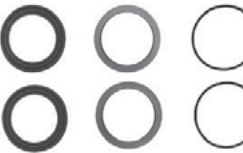


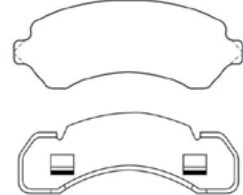
Product	Part Number	Description	Replaces	Outer Backing Plate Length	Lining Length	Inner Backing Plate Length	Lining Length
BENDIX HYDRAULIC DISC BRAKE PARTS - 3.38" SINGLE PISTON							
	R40H5519	Hardware Kit (for 1 wheel) for Bendix Hydraulic Disc Brakes - 3.38" Single Piston	Bendix H5519 ITEC 44225C1 ITEC 571667C1				
No Image Available	R4066780	Boot & Seal Kit for Bendix Hydraulic Disc Brakes - 3.38" Single Piston	Bendix 66780				
	R40HS010	Guide Bolt for Bendix Hydraulic Disc Brakes - 3.38" Single Piston	Bendix H5010 ITEC 442198C1				
	R40S0021	Caliper Piston - 3.375" Diam. Steel for Bendix Hydraulic Disc Brakes - 3.38" Single Piston	Bendix 90021				
	MD184	D380-I - molded inner brake pad for Bendix Hydraulic Disc Brakes - 3.38" Single Piston D380-O - molded outer brake pad for Bendix Hydraulic Disc Brakes - 3.38" Single Piston	ITEC 990952093	10-1/16"	10"	8-5/64"	
	MMD184	D380-I - molded inner brake pad for Bendix Hydraulic Disc Brakes - 3.38" Single Piston D380-O - molded outer brake pad for Bendix Hydraulic Disc Brakes - 3.38" Single Piston	ITEC 990952093	10-1/16"	10"	8-5/64"	
	MD380	D380-I - molded inner brake pad for Bendix Hydraulic Disc Brakes - 3.38" Single Piston D380-O - molded outer brake pad for Bendix Hydraulic Disc Brakes - 3.38" Single Piston	ITEC 990952094	10-1/16"	10"	8-5/64"	

MD = Standard Pads
MVD = Value Pads
MMD = Frequent Stop Pads

Information & Images Provided by Bendix

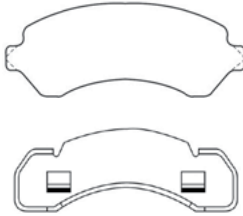
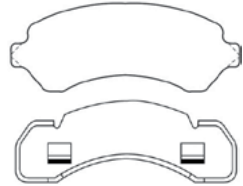
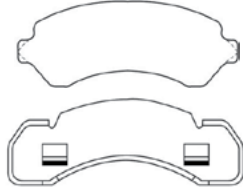
Product	Part Number	Description	Replaces	Outer Backing Plate Length	Lining Length	Inner Backing Plate Length	Lining Length
	MVD380	D380-I - molded inner brake pad for Bendix Hydraulic Disc Brakes - 3.38" Single Piston D380-O - molded outer brake pad for Bendix Hydraulic Disc Brakes - 3.38" Single Piston	ITEC 990952095	10-1/16"	10"	8-5/64"	

BENDIX HYDRAULIC DISC BRAKE PARTS - 2.60" TWIN PISTON





	R40H5519	Hardware Kit (for 1 wheel) for Bendix Hydraulic Disc Brake - 2.90" Twin Piston Second design - effective with model year 1989	Bendix H5634 ITEC 44225C1 ITEC 571667C1				
	R4010771	Boot & Seal Kit for Bendix Hydraulic Disc Brake - 2.90" Twin Piston Second design - effective with model year 1989	Bendix 10771				
	R40HS010	Guide Bolt for Bendix Hydraulic Disc Brake - 2.90" Twin Piston Second design - effective with model year 1989	Bendix H5010 ITEC 442198C1				
	R4090100P	Caliper Piston - 2.60" Diam. Phenolic Steel for Bendix Hydraulic Disc Brake - 2.90" Twin Piston Second design - effective with model year 1989	Bendix 4151728				
	MD184	D380-I - molded inner brake pad for Bendix Hydraulic Disc Brakes - 2.90" Twin Piston D380-O - molded outer brake pad for Bendix Hydraulic Disc Brakes - 2.90" Twin Piston	ITEC 990952C93	10-1/16"	10"	8-5/64"	

MD = Standard Pads
MVD = Value Pads
MMD = Frequent Stop Pads

Information & Images Provided by Bendix





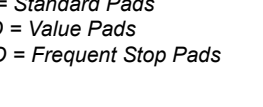

Product	Part Number	Description	Replaces	Outer Backing Plate Length	Lining Length	Inner Backing Plate Length	Lining Length
	MMD184	D380-I - molded inner brake pad for Bendix Hydraulic Disc Brakes - 2.90" Twin Piston D380-O - molded outer brake pad for Bendix Hydraulic Disc Brakes - 2.90" Twin Piston	ITEC 990952C93	10-1/16"	10"	8-5/64"	
	MD380	D380-I - molded inner brake pad for Bendix Hydraulic Disc Brakes - 2.90" Twin Piston D380-O - molded outer brake pad for Bendix Hydraulic Disc Brakes - 2.90" Twin Piston	ITEC 990952C93	10-1/16"	10"	8-5/64"	
	MVD380	D380-I - molded inner brake pad for Bendix Hydraulic Disc Brakes - 2.90" Twin Piston D380-O - molded outer brake pad for Bendix Hydraulic Disc Brakes - 2.90" Twin Piston	ITEC 990952C93	10-1/16"	10"	8-5/64"	

BENDIX HYDRAULIC DISC BRAKE PARTS - 2.88" TWIN PISTON

	R40H5522	Hardware Kit (for 1 wheel) for Bendix Hydraulic Disc Brake - 2.88" Twin Piston Second design - effective with model year 1988 ITEC, & GM Medium-Duty Trucks	Bendix H5635 GM 15501010 GM 15501013 ITEC 593644C1 ITEC 592693C1				
	R4066365	Boot & Seal Kit for Bendix Hydraulic Disc Brake - 2.88" Twin Piston Second design - effective with model year 1988 ITEC, & GM Medium-Duty Trucks	Bendix 66381				
	R40H5010	Guide Bolt for Bendix Hydraulic Disc Brake - 2.88" Twin Piston Second design - effective with model year 1988 ITEC, & GM Medium-Duty Trucks	Bendix H5010 ITEC 442198C1				
	R4090096	Caliper Piston - 2.60" Diam. Phenolic Steel for Bendix Hydraulic Disc Brake - 2.88" Twin Piston Second design - effective with model year 1988 ITEC, & GM Medium-Duty Trucks	Bendix 4151728				

MD = Standard Pads
MVD = Value Pads
MMD = Frequent Stop Pads

Information & Images Provided by Bendix




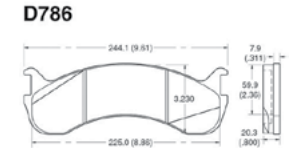
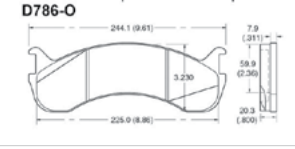
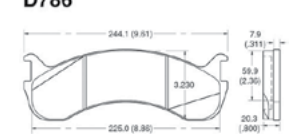
Product	Part Number	Description	Replaces	Outer Backing Plate Length	Lining Length	Inner Backing Plate Length	Lining Length
 D225-I	MD225	D225-I - Inner Brake Pad for Bendix Hydraulic Disc Brakes - 2.88" Twin Piston	ITEC 1694274C91 ITEC 990952C93	10-5/8"	10-1/2"	8-5/64"	
 D225-O		D225-O - outer brake pad for Bendix Hydraulic Disc Brakes - 2.88" Twin Piston					
 D225-I	MMD225	D225-I - Inner Brake Pad for Bendix Hydraulic Disc Brakes - 2.88" Twin Piston	ITEC 1694274C91 ITEC 990952C94	10-5/8"	10-1/2"	8-5/64"	
 D225-O		D225-O - outer brake pad for Bendix Hydraulic Disc Brakes - 2.88" Twin Piston					
 D225-I	MVD225	D225-I - Inner Brake Pad for Bendix Hydraulic Disc Brakes - 2.88" Twin Piston	ITEC 1694274C91 ITEC 990952C95	10-5/8"	10-1/2"	8-5/64"	
 D225-O		D225-O - outer brake pad for Bendix Hydraulic Disc Brakes - 2.88" Twin Piston					

MD = Standard Pads
MVD = Value Pads
MMD = Frequent Stop Pads

Information & Images Provided by Bendix



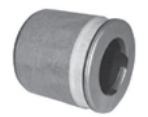

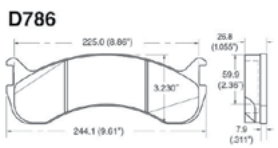
BOSCH HYDRAULIC DISC BRAKE PARTS FROM MERITOR

Table 1-65: Hydraulic Brakes From Meritor

Product	Part Number	Description	Replaces
MERITOR HYDRAULIC DISC BRAKE PARTS - 66MM			
	R4011754	Guide Pin Kit (for 1 wheel) for Bosch Hydraulic Disc Brakes - 66mm	Bosch BX4153343 - 2 Slippers Bosch BX4153232 - 2 Guide Pin Boots Bosch BX4153231 - 2 Guide Pins Bosch BX4153235 - 2 Guide Pin Bolts
	R404153343	Guide Pin Slipper (for 1 wheel) for Bosch Hydraulic Disc Brakes - 66mm	Bosch BX4153343 - 4 Slippers
	R4011752	Boot & Seal Kit for Bosch Hydraulic Disc Brakes - 66mm	Bosch BX3213580 (Seal) Bosch BX4153266 (Boot)
	R4011751	Caliper Piston for Bosch Hydraulic Disc Brakes - 66mm	Bosch BX4153264 (Piston)
	MM786A	D786 - Inner & Outer Brake Pads for Bosch Hydraulic Disc Brakes - 66mm	KIT D786A FMSI 7654D786 Thin Set ITEC 2501842C91
	MD786A	D786 - Inner & Outer Brake Pads for Bosch Hydraulic Disc Brakes - 66mm	KIT D786A FMSI 7654D786 Thin Set ITEC 2501842C92
	MVD786A	D786 - Inner & Outer Brake Pads for Bosch Hydraulic Disc Brakes - 66mm	KIT D786A FMSI 7654D786 Thin Set ITEC 2501842C93

MERITOR HYDRAULIC DISC BRAKE PARTS - 73MM

MD = Standard Pads
MVD = Value Pads
MMD = Frequent Stop Pads

Product	Part Number	Description	Replaces
	R4011754	Guide Pin Kit (for 1 wheel) for Bosch Hydraulic Disc Brakes - 73mm	Bosch BX4153343 - 2 Slippers Bosch BX4153232 - 2 Guide Pin Boots Bosch BX4153231 - 2 Guide Pins Bosch BX4153235 - 2 Guide Pin Bolts
	R404153343	Guide Pin Slipper (for 1 wheel) for Bosch Hydraulic Disc Brakes - 73mm	Bosch BX4153343 - 4 Slippers
	R4011758	Boot & Seal Kit for Bosch Hydraulic Disc Brakes - 73mm	Bosch BX22338679 (Seal) Bosch BX4153219 (Boot)
	R4011751	Caliper Piston for Bosch Hydraulic Disc Brakes - 73mm	Bosch BX4153217 (Piston)
D974-O 	MD786	D786 - Inner & Outer Brake Pads for Bosch Hydraulic Disc Brakes - 73mm	KIT 07868 FMSI 7655D786 ITEC 2501842C91
D786 	MM786	D786 - Inner & Outer Brake Pads for Bosch Hydraulic Disc Brakes - 73mm	KIT 07868 FMSI 7655D786 ITEC 2501842C92
	MVD786	D786 - Inner & Outer Brake Pads for Bosch Hydraulic Disc Brakes - 73mm	KIT 07868 FMSI 7655D786 ITEC 2501842C93

MD = Standard Pads
MVD = Value Pads
MMD = Frequent Stop Pads



BRAKE CALIPERS

BENDIX HYDRAULIC CALIPERS

Table 1-66: Bendix Hydraulic Calipers





Part Number	Description	Notes
E14785012BXW	Front Caliper - 2.50" Dayton 4-Hole - Left & Right Hand applications	Cast No. 563
E14784106BXW	Front Caliper - 2.50" Dayton 6-Hole - Left & Right Hand applications	Cast No. 472
E14775006BXW	Front & Rear Caliper - 2.60" - Soft Boot or Hard Boot - without Air Ride Suspension	Cast No. 4151733 - Soft Boot or Hard Boot
E14675011BXW	Front & Rear Caliper - 2.60" - with Cross Over Tube	Cast No. 2238229 - with Cross Over Tube
E14675012BXW	Front & Rear Caliper - 2.60" - without Cross Over Tube	Cast No. 4151020 - without Cross Over Tube
E14775008BXW	Front & Rear Caliper - 2.60" - with Air Ride Suspension	
E14688006BXW	Front & Rear Caliper - 2.88" Rail Slide - 2nd design - Hard Boot - with Air Ride Suspension - Left & Right Hand applications	
E14785008BXW	Front & Rear Caliper - 2.88" Rail Slide - without Air Ride Suspension - Left & Right Hand applications	
E14685009BXW	Front Caliper - 2.88" Bendix - 1st design - Soft Boot - Left & Right Hand applications	1 st & 2 nd design Calipers are interchangeable; their components are not.
E14688006BXW	Front & Rear Caliper - 2.88" - with Air Ride Suspension	
E14771015BXW	Front & Rear Caliper - 3.38" - Left Hand	
E14771014BXW	Front & Rear Caliper - 3.38" - Right Hand	
E14670541BXW	Rear Caliper - 54mm - Left Hand	
E14670540BXW	Rear Caliper - 54mm - Right Hand	
E14770037BXW	Front Caliper - 56mm - Left Hand	
E14770036BXW	Front Caliper - 56mm - Right Hand	
E14670093BXW	Front Caliper - 60mm - Left Hand	
E14670092BXW	Front Caliper - 60mm - Right Hand	
E14770021BXW	Rear Caliper - 60mm - Left Hand	
E14770020BXW	Rear Caliper - 60mm - Right Hand	
E14684015BXW	Front & Rear Caliper - 64mm - with Inlet Brass Insert - 4-Piston Meritor - with Inlet Brass Insert - LH	
E14684014BXW	Front & Rear Caliper - 64mm - with Inlet Brass Insert - 4-Piston Meritor - Right Hand	
E14684017BXW	Front & Rear Caliper - 64mm - without Inlet Brass Insert - 4-Piston Meritor - Left Hand	
E14684016BXW	Front & Rear Caliper - 64mm - without Inlet Brass Insert - 4-Piston Meritor - Right Hand	
E14788008BXW	Front & Rear Caliper - 66mm Pin Slide - 2-Piston Bosch - Left & Right Hand applications	Cast No. 4153269
E14688015BXW	Front & Rear Caliper - 70mm - 4-Piston Meritor - Left Hand	
E14688014BXW	Front & Rear Caliper - 70mm - 4-Piston Meritor - Right Hand	
E14684013BXW	Front & Rear Caliper - 70mm - 4-Piston Meritor - with Inlet Brass Insert - Left Hand	
E14684012BXW	Front & Rear Caliper - 70mm - 4-Piston Meritor - with Inlet Brass Insert - Right Hand	
E14684019BXW	Front & Rear Caliper - 70mm - without Inlet Brass Insert - Left Hand	
E14684018BXW	Front & Rear Caliper - 70mm - without Inlet Brass Insert - Right Hand	
E14788010BXW	Front & Rear Caliper - 73mm Pin Slide - 2-Piston Bosch - Left & Right Hand applications	Cast No. 4153222

Information & Images Provided by Bendix







MERITOR HYDRAULIC CALIPERS





Table 1-67: Meritor Hydraulic Calipers

Product	Part Number	Description	Replaces	Disc Pad Set No.	Hardware Kit	Application
MERITOR CALIPER - 2.362" (60MM) TWIN PISTON - LEFT HAND						
	R42R55605	Caliper - 2.362" (60mm) Twin Piston - Left Hand	Bendix R55605 EIS - no part number available IBP 4812 IBP F1D3DL Raybestos RWC-7026 Wagner CR130127	MD411, MMD411	R40H5735 (Services one axle)	Ford
MERITOR CALIPER - 2.362" (60MM) TWIN PISTON - RIGHT HAND						
	R42R55604	Caliper - 2.362" (60mm) Twin Piston - Right Hand	Bendix R55604 EIS - no part number available IBP 4811 IBP F103DR Raybestos RWC-7025 Wagner CR130128	MD411, MMD412	R40H5735 (Services one axle)	Ford
MERITOR CALIPER - 2.60" BENDIX TWIN PISTON - LEFT & RIGHT HAND APPLICATIONS						
	R42R55717, R4255717	Caliper - 2.60" Bendix Twin Piston - Left & Right Hand applications	Bendix 55717	MD380, MMD380	R40H5522 (Services one Wheel)	n/a
	R42R55313, R4255313	Caliper - 2.60" Bendix Twin Piston - Left & Right Hand applications	Bendix 55313	MD380, MMD380	R40H5522 (Services one Wheel)	n/a
MERITOR CALIPER - 2.88" BENDIX TWIN PISTON - SECOND DESIGN (POST 1988) - LEFT & RIGHT HAND APPLICATIONS						
Image Not Available	R42R55250, R4255250	Caliper - 2.88" Bendix Twin Piston - Second design (post 1988) - Left & Right Hand applications	Bendix 055250 Dayton 60-050175 EIS RC6574 GMC 1550101,15514583 IBP 4901/2, M3001 L/R ITE 1658443C91 Raybestos RWC-7700 Wagner CR120549	MD225, MMD225	R40H5522 (Service one wheel)	n/a

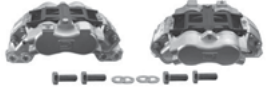


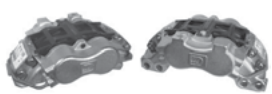
Information & Images Provided by Meritor

Product	Part Number	Description	Replaces	Disc Pad Set No.	Hardware Kit	Application
MERITOR CALIPER - 2.88" BENDIX TWIN PISTON - LEFT & RIGHT HAND APPLICATIONS						
Image Not Available	R4255656, R42R55656	Caliper - 2.88" Bendix Twin Piston - Left & Right Hand applications	Bendix 55656	MD225, MMD225	R40H5522 (Services one wheel)	Freightliner
MERITOR CALIPER - 3.38" (3-3/8") SINGLE PISTON - LEFT HAND						
	R42R55098, R4255098	Caliper - 3.38" (3-3/8") Single Piston - Left Hand	Bendix 55099 EIS RC60B7 IBP 4910 IBP M3005L Raybestos RWC-S09B Wagner CR130211	MD184, MD380	R40H5519 (Services one wheel)	Medium- Duty ITE
MERITOR CALIPER - 3.38" (3-3/8") SINGLE PISTON - RIGHT HAND						
	R42R55099, R4255099	Caliper - 3.38" (3-3/8") Single Piston - Right Hand	Bendix 55098 EIS RC6088 IBP 4909 IBP M3005R Raybestos RWC-5099 Wagner CR13D210	MD184, MD380	R40H5519 (Services one wheel)	Medium- Duty ITE
MERITOR CALIPER - 45MM TWIN PISTON - LEFT HAND						
	R4255858, R42R55858	Caliper - 45mm Twin Piston - Left Hand	Bendix 55858 Raybestos - no part number available Ford XC2Z2553AD	MD411, MMD411	R40H5735	Ford E250 /350
MERITOR CALIPER - 45MM TWIN PISTON - RIGHT HAND						
	R4255857, R42R55857	Caliper - 45mm Twin Piston - Right Hand	Bendix 55857 Raybestos - no part number available Ford XC2Z2552AD	MD411, MMD411	R40H5735	Ford E250 /350
MERITOR CALIPER - 48MM TWIN PISTON - LEFT HAND						
Image Not Available	R42R65534	Caliper - 48mm Twin Piston - Left Hand	no information available	MD1329, MMD1329	n/a	Ford
MERITOR CALIPER - 48MM TWIN PISTON - RIGHT HAND						
Image Not Available	R42R65533	Caliper - 48mm Twin Piston - Right Hand	no information available	MD1329, MMD1329	n/a	Ford
MERITOR CALIPER - 54MM TWIN PISTON - LEFT HAND						
Image Not Available	R42R65536	Caliper - 54mm Twin Piston - Left Hand	no information available	MD1330, MMD1330	n/a	Ford
MERITOR CALIPER - 54MM TWIN PISTON - RIGHT HAND						
Image Not Available	R42R65535	Caliper - 54mm Twin Piston - Right Hand	no information available	MD1330, MMD1330	n/a	Ford
MERITOR CALIPER - 54MM GM (CLASS 3 VEHICLE) - LEFT HAND						
Image Not Available	R42R55995	Rear Caliper - 54mm GM (Class 3 Vehicle) - Left Hand	Bendix L55995PM	MD989, MMD989	n/a	Chevrolet, GM

Information & Images Provided by Meritor

Product	Part Number	Description	Replaces	Disc Pad Set No.	Hardware Kit	Application
MERITOR CALIPER - 54MM GM (CLASS 3 VEHICLE) - RIGHT HAND						
Image Not Available	R42R55994	Rear Caliper - 54mm GM (Class 3 Vehicle) - Right Hand	Bendix L55994PM	MD989, MMD989	n/a	Chevrolet, GM
MERITOR CALIPER - 57MM GM - LEFT HAND						
Image Not Available	R42R55856	Front Caliper - 57mm GM - Left Hand	Bendix L55856PM	MD784	n/a	n/a
MERITOR CALIPER - 57MM GM - RIGHT HAND						
Image Not Available	R42R55855	Front Caliper - 57mm GM - Right Hand	Bendix L55855PM	MD784	n/a	n/a
MERITOR CALIPER - 60MM TWIN PISTON - LEFT HAND						
	R4255605, R42R55605	Caliper - 60mm Twin Piston - Left Hand	Bendix 55605 Ford E8TZ2B121A Raybestos RWC7025	MD411, MMD411	R40H5735	Ford F450; Front & Rear 1988-97
MERITOR CALIPER - 60MM TWIN PISTON - RIGHT HAND						
	R4255604, R42R55604	Caliper - 60mm Twin Piston - Right Hand	Bendix 55604 Ford E8TZ2B120A Raybestos RWC7026	MD411, MMD411	R40H5735	Ford F450; Front & Rear 1988-97
MERITOR CALIPER - 64MM QUADRAULIC PHENOLIC PISTON - LEFT & RIGHT HAND APPLICATIONS						
	60450474001	Caliper - 64mm quadraulic phenolic piston - Left & Right Hand applications	Meritor 60450474 - No Disc Pads Meritor 60450474001 - Includes Disc Pads	K1TD769AM, MD769, MMD769	R4011729 (Services 1 wheel)	n/a
	60450473001	Caliper - 64mm quadraulic phenolic piston - Left & Right Hand applications	no information available	K1T D769AM, MD769, MMD770	R4011729 (Services 1 wheel)	n/a
	60450476, 60450476007, 60450476006	Caliper - 64mm quadraulic phenolic piston - Left & Right Hand applications	ITE 3821734C91	K1TD769707	R4011729	ITech, Ford
	60450477, 60450477007, 60450477006	Caliper - 64mm quadraulic phenolic piston - Left & Right Hand applications	ITE 3821835C91	K1TD769707	R4011729	ITech, Ford
MERITOR CALIPER - 66MM TWIN PISTON - LEFT & RIGHT HAND APPLICATIONS						
	R4255849 New, R42R55849 Reman	Caliper - 66mm Twin Piston - Left & Right Hand applications	Bendix 55849 Bosch 4153273 ITE 2501839C91	MD786A, MMD786A	R4011754 (Services 1 wheel)	n/a


Information & Images Provided by Meritor

Product	Part Number	Description	Replaces	Disc Pad Set No.	Hardware Kit	Application
MERITOR CALIPER - 70MM (2.76") FOUR PISTON - LEFT HAND INLET PORT FOR MERITOR CALIPER (FACING THE BRIDGE TUBE) -7/16" - 24 THREADS						
	60050313	Caliper - 70mm (2.76") four piston - Left Hand inlet port for caliper (facing the bridge tube) -7/16" - 24 threads	Meritor 60050313	K1T769AM	R4011121 (wheel kit)	GM
MERITOR CALIPER - 70MM (2.76") FOUR PISTON - RIGHT HAND INLET PORT FOR MERITOR CALIPER (FACING THE BRIDGE TUBE) -7/16" - 24 THREADS						
	60050312	Caliper - 70mm (2.76") four piston - Right Hand inlet port for caliper (facing the bridge tube) -7/16" - 24 threads	Meritor 60050312	K1T769AM	R4011121 (wheel kit)	GM
MERITOR CALIPER - 70MM (2.76") FOUR PISTON - LEFT HAND INLET PORT FOR MERITOR CALIPER (FACING THE BRIDGE TUBE) - 10MMX1.5MM BETWEEN THREADS						
	60450454	Caliper - 70mm (2.76") four piston - Left Hand inlet port for caliper (facing the bridge tube) - 10mmx1.5mm between threads	Meritor 60450454 - Includes Disc Pads Meritor 60050320 - No Disc Pads	K1T769AM	R4011121 (wheel kit)	GM
MERITOR CALIPER - 70MM (2.76") FOUR PISTON - RIGHT HAND INLET PORT FOR MERITOR CALIPER (FACING THE BRIDGE TUBE) - 10MMX1.5MM BETWEEN THREADS						
	60450455	Caliper - 70mm (2.76") four piston - Right Hand inlet port for caliper (facing the bridge tube) - 10mmx1.5mm between threads	Meritor 60450455 - Includes Disc Pads Meritor 60050321 - No Disc Pads	K1T769AM	R4011121 (wheel kit)	GM
MERITOR CALIPER - 70MM QUADRAULIC PHENOLIC PISTON - LEFT & RIGHT HAND APPLICATIONS						
Image Not Available	60450478, 60450478006, 60450478007	Caliper - 70mm quadraulic phenolic piston - Left & Right Hand applications. (Can be left or right depending on location.)	ITE 3821826C91 - with MA708 pads	K1TD769707, K1TD769708	R4011729	ITech, Ford


Information & Images Provided by Meritor

Product	Part Number	Description	Replaces	Disc Pad Set No.	Hardware Kit	Application
Image Not Available	60450479, 60450479006, 60450479007	Caliper - 70mm quadrauc phenolic piston - Left & Right Hand applications (Can be left or right depending on location.)	ITE 3821827C91 - with MA708 pads	K1TD769707, K1TD769708	R4011729	ITech, Ford


MERITOR CALIPER - 70MM PHENOLIC PISTON - LEFT HAND INLET PORT FOR MERITOR CALIPER (FACING THE BRIDGE TUBE) -7/16" - 24 THREADS

	60450483	Caliper - 70mm phenolic piston - Left Hand inlet port for caliper (facing the bridge tube) -7/16" - 24 threads	Meritor 60450483 - No Disc Pads Meritor 60450469002 - Includes Disc Pads	K1T769AM	R4011729 (Services 1 wheel)	n/a
---	----------	--	---	----------	-----------------------------	-----

MERITOR CALIPER - 70MM PHENOLIC PISTON - RIGHT HAND INLET PORT FOR MERITOR CALIPER (FACING THE BRIDGE TUBE) -7/16" - 24 THREADS

	60450482	Caliper - 70mm phenolic piston - Right Hand inlet port for caliper (facing the bridge tube) -7/16" - 24 threads	Meritor 60450482 - No Disc Pads Meritor 60450468002 - Includes Disc Pads	K1T769AM	R4011729 (Services 1 wheel)	n/a
---	----------	---	---	----------	-----------------------------	-----

MERITOR CALIPER - 73MM TWIN PISTON - LEFT & RIGHT HAND APPLICATIONS

	R4255850 New, R42R55850 Reman	Caliper - 73mm Twin Piston - Left & Right Hand applications	Bendix 55850 Bosch 4153216 ITE 2501838C91	MD786, MMD786	R4011754 (Services 1 wheel)	n/a
---	----------------------------------	---	---	------------------	-----------------------------	-----

Information & Images Provided by Meritor

BRAKE ROTORS



For Slack Adjusters See pg. 1-50



WEBB® BRAKE ROTORS

Table 1-68: Webb Brake Rotors

Part Number	Description	Type	Outside Diam. (A) (Inches)	Disc Thickness (B) (Inches)	Height (C) (Inches)	Pilot Diam. (D) (Inches)	Bolt Circle (E) (Inches)	Bolt Hole Size (Inches)	Number of Bolt Holes	Comment
5-HOLE HAT										
54102P	Webb Brake Rotor - 5 Hole Hat Rotor	Hat	14.75"	1.34"	3.81"	5.40"	6.75"	0.66"	5	
54769P65	Webb Brake Rotor - 5 Hole Hat Rotor for ABS	Hat	15"	1.43"	3.50"	5.40"	6.75"	0.78"	5	ABS
5-HOLE U										
54255P	Webb Brake Rotor - 5 Hole U Rotor	U	15"	1.44"	4.49"	9.18"	11.25"	0.65"	5	
54256P	Webb Brake Rotor - 5 Hole U Rotor	U	15"	1.44"	4.49"	9.18"	11.25"	0.78"	5	
54282P	Webb Brake Rotor - 5 Hole U Rotor	U	15"	1.43"	6.09"	14.25"	12.75"	0.66"	5	
6-HOLE HAT										
54103P	Webb Brake Rotor - 6 Hole Hat Rotor	Hat	14.75"	1.34"	3.81"	5.40"	7.25"	0.78"	6	
54104P	Webb Brake Rotor - 6 Hole Hat Rotor	Hat	14.75"	1.34"	3.81"	5.40"	6.75"	0.66"	6	
54105P	Webb Brake Rotor - 6 Hole Hat Rotor	Hat	14.75"	1.34"	3.81"	5.40"	7.25"	0.78"	6	Drilled for A
54770P65	Webb Brake Rotor - 6 Hole Hat Rotor for ABS	Hat	15"	1.43"	3.50"	5.40"	6.75"	0.77"	6	ABS
6-HOLE U										
54251P	Webb Brake Rotor - 6 Hole U Rotor	U	15"	1.43"	6.80"	7.00"	8.75"	0.81"	6	
54280P	Webb Brake Rotor - 6 Hole U Rotor	U	15"	1.43"	6.00"	14.25"	12.75"	0.78"	6	
54351P	Webb Brake Rotor - 6 Hole U Rotor	U	15.39"	1.53"	4.75"	9.25"	11.25"	0.78"	6	
54352P	Webb Brake Rotor - 6 Hole U Rotor	U	15.39"	1.53"	6.03"	6.44"	8.75"	0.84"	6	
10-HOLE HAT										
54106P	Webb Brake Rotor- 10 Hole Hat Rotor	Hat	14.75"	1.34"	3.81"	6.00"	7.25"	0.59"	10	

Information & Images Provided by Webb®

Part Number	Description	Type	Outside Diam. (A) (Inches)	Disc Thickness (B) (Inches)	Height (C) (Inches)	Pilot Diam. (D) (Inches)	Bolt Circle (E) (Inches)	Bolt Hole Size (Inches)	Number of Bolt Holes	Comment
54301P	Webb Brake Rotor - 10 Hole Hat Rotor	Hat	15.39"	1.53"	3.40"	6.00"	7.25"	0.59"	10	

10-HOLE U

54281P	Webb Brake Rotor - 10 Hole U Rotor	U	15"	1.43"	6.79"	9.37"	11.25"	0.81"	10	
54360P	Webb Brake Rotor - 10 Hole U Rotor	U	15.39"	1.53"	6.07"	8.69"	11.25"	0.84"	10	

10-HOLE HAT FOR ABS

54771P65	Webb Brake Rotor - 10 Hole Hat Rotor for ABS	Hat	15"	1.43"	4.44"	6.00"	7.25"	0.58"	10	ABS
54773P65	Webb Brake Rotor - 10 Hole Hat Rotor for ABS	Hat	15"	1.43"	3.21"	6.00"	7.25"	0.58"	10	ABS
54775P65	Webb Brake Rotor - 10 Hole Hat Rotor for ABS	Hat	15.38"	1.53"	3.40"	6.00"	7.25"	0.58"	10	ABS

Information & Images Provided by Webb®

PERFORMANCE FRICTION BRAKE ROTORS

Table 1-69: Performance Friction Brake Rotors

Part Number	Description	Type	Outside Diameter (A)	Disc Thickness (B)	Height (C)	Pilot Diameter (D)	Bolt Circle (E)	Bolt Hole Size	Number of Bolt Holes	Comment
-------------	-------------	------	----------------------	--------------------	------------	--------------------	-----------------	----------------	----------------------	---------

5-HOLE HAT

PFC381.089.20	Performance Friction Brake Rotor - 5 Hole Hat Rotor	Hat	15	1.44"	3.50"	5.403"	6.75"	0.781"	5	
---------------	---	-----	----	-------	-------	--------	-------	--------	---	--

10-HOLE HAT

PFC381.081.20	Performance Friction Brake Rotor - 10 Hole Hat Rotor	Hat	15	1.44"	3.20"	6.002"	7.25"	0.579"	10	
PFC381.082.20	Performance Friction Brake Rotor - 10 Hole Hat Rotor	Hat	15	1.44"	3.21"	6.002"	7.25"	0.594"	10	

10-HOLE U

PFC381.181.30	Performance Friction Brake Rotor - 10 Hole U Rotor	U	15	1.44"	7.11"	9.505"	11.25"	0.816"	10	
---------------	--	---	----	-------	-------	--------	--------	--------	----	--



BENDIX BRAKE ROTORS

Table 1-70: Bendix Brake Rotors

Product	Part Number	Description	Type	Outside Diam. (A)	Disc Thickness (B)	Height (C)	Pilot Diam. (D)	Bolt Circle (E)	Bolt Hole Size	Number of Bolt Holes	Comment
---------	-------------	-------------	------	-------------------	--------------------	------------	-----------------	-----------------	----------------	----------------------	---------

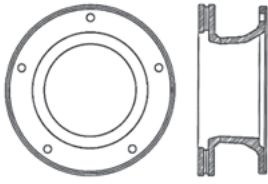
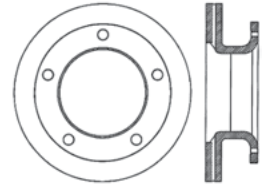
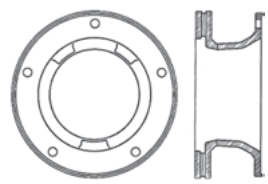
5-HOLE HAT

	E12588021BXW	Bendix Brake Rotor - 5 Hole Hat Rotor (Mount: Behind Hub) for 2-Piston Caliper	Hat	15.00"	1.40"	3.50"	5.40"	6.70"	.80"	5	ABS exciter teeth in casting
	E12585013BXW	Bendix Brake Rotor - 5 Hole Hat Rotor (Mount: Behind Hub) for Dayton Calipers	Hat	14.80"	1.30"	3.80"	5.40"	6.80"	.70"	5	
	E12585012BXW	Bendix Brake Rotor - 5 Hole Hat Rotor (Mount: Behind Hub) for Dayton Calipers	Hat	14.80"	1.30"	3.80"	6.25"	6.80"	.70"	5	

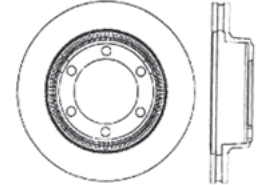
5-HOLE U

	E12588005BXW	Bendix Brake Rotor - 5 Hole U Rotor	U	15.00"	1.44"	4.26"	9.00"	10.50"	.65"	5	
	E12588007BXW	Bendix Brake Rotor - 5 Hole U Rotor	U	15.00"	1.40"	4.50"	9.20"	11.30"	.663"	5	
	E12588011BXW	Bendix Brake Rotor - 5 Hole U Rotor	U	15.00"	1.40"	4.50"	9.20"	11.30"	.70"	5	
	E12588014BXW	Bendix Brake Rotor - 5 Hole U Rotor	U	15.00"	1.44"	5.25"	13.75"	11.25"	.65"	5	

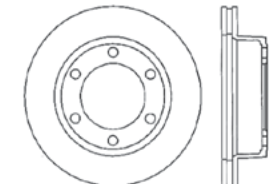
Information & Images Provided by Bendix

Product	Part Number	Description	Type	Outside Diam. (A)	Disc Thickness (B)	Height (C)	Pilot Diam. (D)	Bolt Circle (E)	Bolt Hole Size	Number of Bolt Holes	Comment
	E12588008BXW	Bendix Brake Rotor - 5 Hole U Rotor	U	15.00"	1.40"	6.10"	14.3"	12.80"	.662"	5	
	E12588022BXW	Bendix Brake Rotor - 5 Hole U Rotor for 2-Piston Caliper	U	15.00"	1.40"	4.90"	9.20"	11.30"	.80"	5	
	E12588013BXW	Bendix Brake Rotor - 5 Hole U Rotor for 2-Piston Caliper	U	15.00"	1.40"	6.10"	14.3"	12.80"	.765"	5	

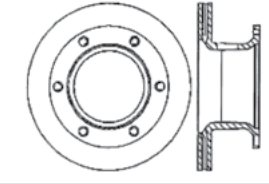
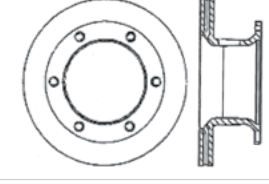
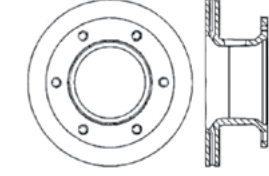
6-HOLE HAT

	E12588015BXW	Bendix Brake Rotor - 6 Hole Hat Rotor (Mount: Behind Hub)	Hat	15.00"	1.40"	3.50"	5.40"	6.70"	.80"	6	
	E12584020BXW	Bendix Brake Rotor - 6 Hole Hat Rotor (Mount: Behind Hub) for 2.50" Caliper	Hat	14.70"	1.30"	96.7"	5.40"	7.30"	.80"	6	
	E12588020BXW	Bendix Brake Rotor - 6 Hole Hat Rotor (Mount: Behind Hub) for 2-Piston Caliper	Hat	15.00"	1.40"	3.50"	5.40"	6.70"	.80"	6	
	E12585010BXW	Bendix Brake Rotor - 6 Hole Hat Rotor (Mount: Behind Hub) for Dayton Calipers	Hat	14.80"	1.30"	3.80"	6.25"	6.80"	.70"	6	

Information & Images Provided by Bendix

Product	Part Number	Description	Type	Outside Diam. (A)	Disc Thickness (B)	Height (C)	Pilot Diam. (D)	Bolt Circle (E)	Bolt Hole Size	Number of Bolt Holes	Comment
	E12685009BXW	Bendix Brake Rotor - 6 Hole Hat Rotor for Dayton Calipers	Hat	14.70"	1.30"	3.80"	5.40"	6.70"	.70"	6	

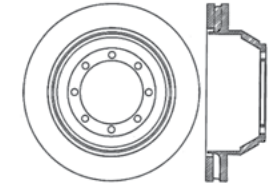
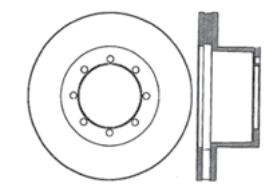
6-HOLE U

	E12588006BXW	Bendix Brake Rotor - 6 Hole U Rotor	U	15.00"	1.44"	6.80"	7.00"	8.75"	.80"	6	
	E12584019BXW	Bendix Brake Rotor - 6 Hole U Rotor for 2.88" Caliper	U	15.38"	1.54"	4.75"	9.25"	11.25"	.78"	6	
	E12684022BXW	Bendix Brake Rotor - 6 Hole U Rotor for 2.88" Caliper	U	15.38"	1.54"	6.02"	6.44"	8.75"	.84"	6	

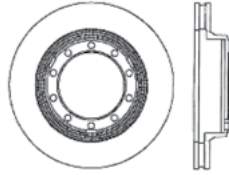
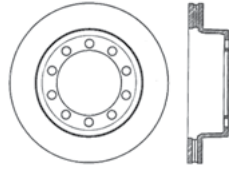
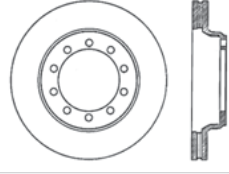
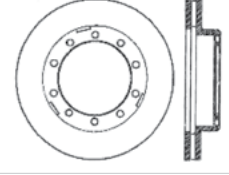
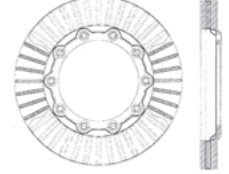
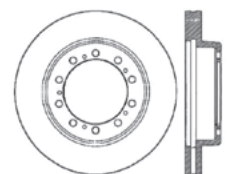
8-HOLE U

	E12584025BXW	Bendix Brake Rotor - 8 Hole U Rotor for 2.88" Calipers	U	15.38"	1.54"	7.80"	8.35"	10.83"	.84"	8	
---	--------------	--	---	--------	-------	-------	-------	--------	------	---	--

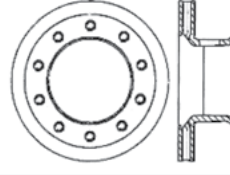
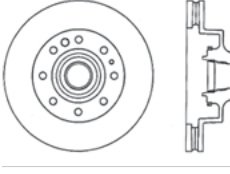
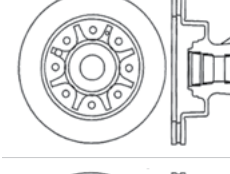
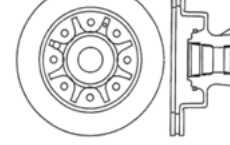
8-HOLE HAT

	E12570132BXW	Bendix Brake Rotor - 8 Hole Hat Rotor (Mount: Behind Hub)	Hat	13.6"	1.60"	4.60"	4.90"	5.70"	.50"	8	
	E12570069BXW	Bendix Brake Rotor - 8 Hole Hat Rotor (Mount: Behind Hub)	Hat	12.90"	1.50"	4.88"	4.86"	5.71"	.51"	8	

Information & Images Provided by Bendix

Product	Part Number	Description	Type	Outside Diam. (A)	Disc Thickness (B)	Height (C)	Pilot Diam. (D)	Bolt Circle (E)	Bolt Hole Size	Number of Bolt Holes	Comment
	E12588018BXW	Bendix Brake Rotor - 10 Hole Hat Rotor (Mount: Behind Hub) for 2-Piston Caliper	Hat	15.00"	1.44"	4.45"	5.99"	7.25"	.59"	10	ABS exciter teeth in casting
	E12588019BXW	Bendix Brake Rotor - 10 Hole Hat Rotor (Mount: Behind Hub) for 2-Piston Caliper	Hat	15.00"	1.44"	3.21"	6.01"	7.25"	.58"	10	ABS exciter teeth in casting
	E12584027BXW	Bendix Brake Rotor - 10 Hole Hat Rotor for 2.50" Caliper	Hat	14.70"	1.30"	3.80"	6.00"	7.30"	.80"	10	
	E12584028BXW	Bendix Brake Rotor - 10 Hole Hat Rotor for 2.88" Caliper	Hat	15.40"	1.50"	3.40"	6.00"	7.30"	.70"	10	
	E12585019BXW	Bendix Brake Rotor - 10 Hole Hat Rotor for 4-Piston Caliper	Hat	15.35"	1.54"	3.45"	6.00"	7.25"	.58"	10	
	E12588025BXW	Bendix Brake Rotor - 10 Hole Flat (Hat) (Mount: Behind Hub) Rotor - 1.89" Tall	Flat/Compact Hat	15.40"	1.50"	1.90"	7.40"	8.60"	.50"	10	
	E12585006BXW	Bendix Brake Rotor - 10 Hole Hat Rotor for Bendix Calipers without Cast Flange	Hat	15.37"	1.44"	3.40"	6.00"	7.25"	.60"	10	without Cast Flange

Information & Images Provided by Bendix

Product	Part Number	Description	Type	Outside Diam. (A)	Disc Thickness (B)	Height (C)	Pilot Diam. (D)	Bolt Circle (E)	Bolt Hole Size	Number of Bolt Holes	Comment
	E12584021BXW	Bendix Brake Rotor - 10 Hole U Rotor for 2.88" Caliper	U	15.38"	1.54"	6.07"	8.69"	11.25"	.84"	10	
	E12585020BXW	Bendix Brake Rotor - 10 Hole U Rotor for 4-Piston Caliper	U	15.35"	1.54"	7.61"	7.30"	11.25"	.93"	10	
	E12588012BXW	Bendix Brake Rotor - 10 Hole U Rotor for Piston Caliper	U	15.00"	1.43"	6.80"	9.37"	11.25"	.76"	10	
	E12585007BXW	Bendix Brake Rotor - 10 Hole U Rotor for Bendix Calipers with Cast Flange	U	15.38"	1.54"	6.18"	9.50"	11.25"	.81"	10	with Cast Flange
8-HOLE HUB & ROTOR UNITS											
	E12570131BXW	Bendix Brake Rotor - 8 Hole Hat Hub & Rotor	Hub & Hat Rotor	13.6"	1.60"	8.00"	4.90"	6.50"	.60"	8	
	E12570048BXW	Bendix Brake Rotor - 8 Hole Hat Hub & Rotor for Rear ABS	Hub & Hat Rotor	13.03"	1.18"	7.89"	4.87"	6.50"	.563"	8	
	E12570047BXW	Bendix Brake Rotor - 8 Hole Hat Hub & Rotor for 4-Wheel ABS	Hub & Hat Rotor	13.03"	1.18"	7.89"	4.87"	6.50"	.563"	8	

Information & Images Provided by Bendix

Application for Bendix Rotors	Position	Part Number
Ford - E450, 47 (1 Ton) Super Duty Van & Cutaway - 1996 - 2001	Front Rotor	E125-70-048
Ford - E450, 47 (1 Ton) Super Duty Van & Cutaway - 1996 - 2007	Rear Rotor	E125-70-069
Ford - E450, 47 (1 Ton) Super Duty Van & Cutaway - 2008 - 2010	Front Rotor	E125-70-131
Ford - E450, 47 (1 Ton) Super Duty Van & Cutaway - 2008 - 2010	Rear Rotor	E125-70-132

Application for Bendix Rotors	Position	Part Number
International/IC Bus - 180, 1800 Series S Models, School Bus, S1823, S1853 School Bus, S1853FC, S1824, S1854 Conventional - (1983 - 1989)	Front Rotor	E125-88-013
International/IC Bus - 180, 1800 Series S Models, School Bus, S1823, S1853 School Bus, S1853FC, S1824, S1854 Conventional - (1983 - 1989)	Rear Rotor	E125-88-014
International/IC Bus - 180, 1800 Series S Models, School Bus, S1823, S1853 School Bus, S1853FC, S1824, S1854 Conventional - (1983 - 1989)	Front & Rear Rotor	E125-88-018
International/IC Bus - 180, 1800 Series S Models, School Bus, S1823, S1853 School Bus, S1853FC, S1824, S1854 Conventional - (1983 - 1989), (1990 - 1993)	Front or Rear Rotor	E125-88-011
International/IC Bus - 180, 1800 Series S Models, School Bus, S1823, S1853 School Bus, S1853FC, S1824, S1854 Conventional - (1983 - 1989), (1990 - 1993)	Front Rotor	E125-88-015
International/IC Bus - 180, 1800 Series S Models, School Bus, S1823, S1853 School Bus, S1853FC, S1824, S1854 Conventional - (1983 - 1989), (1990 - 1993), (1998-2008), (2009)	Front & Rear Rotor	E125-88-021
International/IC Bus - 3200, 3600, 3700, 3800, 3900FC School Bus with Hydraulic Disc Brakes - (1990 - 1993), (1994 - 1997)	Front Rotor	E125-88-015
International/IC Bus - 3200, 3600, 3700, 3800, 3900FC School Bus with Hydraulic Disc Brakes - (1990 - 1993), (1994 - 1997), (1998 - 2008), (2009)	Front & Rear Rotor	E125-88-018
International/IC Bus - 3200, 3600, 3700, 3800, 3900FC School Bus with Hydraulic Disc Brakes - (1994 - 1997), (1998 - 2008), (2009)	Front & Rear Rotor	E125-88-019
International/IC Bus - 3200, 3600, 3700, 3800, 3900FC School Bus with Hydraulic Disc Brakes - (1998 - 2008)	Front & Rear Rotor	E125-88-020
International/IC Bus - 3200, 3600, 3700, 3800, 3900FC School Bus with Hydraulic Disc Brakes - (2009), (2010 - 2011)	Front & Rear Rotor	E125-88-025
International/IC Bus - BE, CE, HC, LC with Hydraulic Disc Brakes - (2002 - 2008)	Front & Rear Rotor	E125-88-018
International/IC Bus - BE, CE, HC, LC with Hydraulic Disc Brakes - (2002 - 2008)	Front & Rear Rotor	E125-88-019

INTERNATIONAL/IC Bus

Table 1-89: Rotors (Bendix) - International/IC Bus

Application for Bendix Rotors	Position	Part Number
International/IC Bus - 170, 1700 Series School Bus, 1723 Bus - (1983 - 1985)	Front Rotor	E125-88-006
International/IC Bus - 170, 1700 Series School Bus, 1723 Bus - (1983 - 1985)	Front Rotor	E125-88-007
International/IC Bus - 170, 1700 Series School Bus, 1723 Bus - (1983 - 1985)	Front or Rear Rotor	E125-88-011
International/IC Bus - 170, 1700 Series School Bus, 1723 Bus - (1983 - 1985)	Front Rotor	E125-88-015
International/IC Bus - 170, 1700 Series School Bus, 1723 Bus - (1983 - 1985)	Front & Rear Rotor	E125-88-018
International/IC Bus - 170, 1700 Series School Bus, 1723 Bus - (1983 - 1985)	Front & Rear Rotor	E125-88-021
International/IC Bus - 170, 1700 Series School Bus, 1723 Bus - (1983 - 1985)	Rear Rotor	E125-88-014
International/IC Bus - 180, 1800 Series S Models, School Bus, S1823, S1853 School Bus, S1853FC, S1824, S1854 Conventional - (1973 - 1982)	Front Rotor	E125-88-005
International/IC Bus - 180, 1800 Series S Models, School Bus, S1823, S1853 School Bus, S1853FC, S1824, S1854 Conventional - (1973 - 1982), (1983 - 1989)	Front Rotor	E125-88-006
International/IC Bus - 180, 1800 Series S Models, School Bus, S1823, S1853 School Bus, S1853FC, S1824, S1854 Conventional - (1983 - 1989)	Front Rotor	E125-88-008

Application for Bendix Rotors	Position	Part Number
International/IC Bus - BE, CE, HC, LC with Hydraulic Disc Brakes - (2009), (2010)	Front & Rear Rotor	E125-88-025
International/IC Bus - 180, 1800 Series S Models, School Bus, S1823, S1853 School Bus, S1853FC, S1824, S1854 Conventional - (1973 - 1982), (1983 - 1989)	Front Rotor	E125-88-007
International/IC Bus (Int'l Harvester) - 180, 1800 Series S Models, School Bus, S1823, S1853 School Bus, S1853FC, S1824, S1854 Conventional - (1983 - 1989)	Front Rotor	E125-88-012
International /IC Bus (Int'l Harvester) - 3200, 3600, 3700, 3800, 3900FC School Bus with Hydraulic Disc Brakes - (1990 - 1993), (1994 - 1997)	Front Rotor	E125-88-012

BRAKE CHAMBERS



TRP® BRAKE CHAMBERS

Table 1-90: TRP® Brake Chambers

Part Number	Description	Comment
SB3030CC	3030 Brake Chamber with Clevis	3-year Warranty
SB3030CL	3030 Brake Chamber - Long Stroke	3-year Warranty
SB3030CH	3030 Brake Chamber for 14" INTRAAX	3-year Warranty
SB3030PK	3030 Piggyback Kit - Standard	3-year Warranty
SB3030PKL	3030 Piggyback Kit - Long Stroke	3-year Warranty

HALDEX BRAKE CHAMBERS

Table 1-91: Haldex Brake Chambers

Part Number	Description	Comment
GP3030KP40	3030 Piggyback Kit - Gold Seal	Piggyback 3030 Chamber for International and Thomas Built Buses
SC30	Type 30 Service Chamber	Type 30 Service Chamber
GC3030P40	3030 Brake Chamber - Gold Seal	Standard Combo 3030 Chamber for International and Thomas Built Buses
LC3030P40	3030 Brake Chamber - Life Seal	Upgraded 3030 chamber with 6-year Warranty
LP3030KP40	3030 Piggyback Kit - Life Seal	Upgraded 3030 Piggyback Kit with 6-year Warranty

CROSS REFERENCE

CROSS REFERENCE FOR BRAKES

Table 1-92: Cross Reference for Brake Chambers

Mfr.	Mfr. Part Number	TRP® Part Number
MGM	3430051X	SB3030CC
MGM	3230051X	SB3030CL
MGM	3430008X	SB3030PK
MGM	3230008X	SB3030PKL
Haldex Gold Seal	GC3030P40	SB3030CC
Haldex Gold Seal	GC3030LP40M1D	SB3030CL
Haldex Gold Seal	GP3030KP40	SB3030PK
Haldex Gold Seal	GP3030LKP40	SB3030PKL
Ranger	PLBTS-3030LS	SB3030CL
Ranger	PLBPS-3030K	SB3030PK
Ranger	PLBPS-3030KLS	SB3030PKL

Table 1-93: Cross Reference for Brake Drums

Mfr.	Mfr Part Number	Part Number
Gunite	3402	66873B
Gunite	3630	65710B
Gunite	3647	66353B
Gunite	3677	65710B
Gunite	3687	65152B
Gunite	3710	65710B
Gunite	3783	66800B
Gunite	3295A	68981B
Gunite	3573X	65710B
Gunite	3576X	76884B
Gunite	3600AX	76864B
Gunite	3600AX	66864B
Gunite	3647X	66353B
Gunite	3687X	65152B

Mfr.	Mfr Part Number	Part Number
Gunite	3710X	65710B
Gunite	3721AX	71528B
Gunite	3767X	65516B
Gunite	3773X	76884B
Gunite	3782X	66800B
Gunite	3807A	76854B
Gunite	3807AX	76854B
Gunite	7002X	65710B
KIC	54201:018	71528B
KIC	54229:018	76854B
KIC	54248:018	65152B
KIC	54261:018	76884B
KIC	60001:018	76864B
KIC	60001:018	66864B
Meritor	123207	76864B
Meritor	123207	66864B
Meritor	123254	71528B
Meritor	123365	76884B
Meritor	123370	65710B
Meritor	123371	65710B
Meritor	123382	71528B
Meritor	123383	65710B
Meritor	123388	65710B
Meritor	123399	65152B
Meritor	123420	71528B
Meritor	123520	66800B
Meritor	123537	76864B
Meritor	123537	66864B
Meritor	123537	76884B
Meritor	123570	76854B
Meritor	3295A	68981B
Meritor	65670B	65670B



*For information, updates, or corrections,
please contact us at TRPBus@TRPParts.com*

*No part of this marketing material may be
reproduced in any manner without written
permission from TRP® North America.*

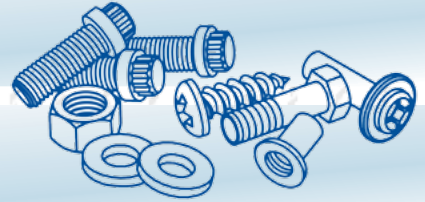
TRP® North America

750 Houser Way N.
Renton, WA 98057

www.trpparts.com



Parts for all brands of buses.



2

BUS PARTS

WHEELS

*Proven, reliable and
always innovative.*

TRP® offers reliable
aftermarket products
that are designed
and tested to exceed
customers' expectations
regardless of the bus
make, model or age.



WHEELS • WHEEL END HARDWARE



BUS PARTS

Tested. Reliable. Guaranteed.

Wheels & Wheel End Hardware

Choosing the right replacement part or service for your vehicle—whether you own one, or a fleet—is one of the most important decisions you can make for your business. And, with tested TRP® parts it's an easy decision.

Regardless of the make you drive, TRP® quality replacement parts are engineered to fit your truck, trailer or bus. Choose the parts that give you the best value for your business. Check them out at an approved TRP® retailer near you.

The cross reference information in this catalog is based upon data provided by several industry sources and our partners. While every attempt is made to ensure the information presented is accurate, we bear no liability due to incorrect or incomplete information.

Product Availability

Due to export restrictions and market demands, not all products are always available in every location. Check for availability in your area with your local TRP® Distributor.

No part of this marketing material may be reproduced in any manner without written permission from TRP® North America.

CONTENTS

WHEELS

Steel Wheels from Accuride	2-4
19.5" Steel Wheels	2-4
22.5" Steel Wheels	2-4
Aluminum Wheels from Accuride	2-5

TRP® WHEEL HARDWARE

TRP® Inner Wheel Nuts	2-6
TRP® Outer Wheel Nuts	2-6
TRP® Outer Disc Wheel Nuts	2-7
TRP® Assorted Wheel Nuts	2-7
Metric Wheel Flange Nuts	2-7
Wheel Rim Nuts	2-7
TRP® Wheel Studs (SAE)	2-7
TRP® Wheel Studs (Metric)	2-9
TRP® Disc Wheel Studs (SAE)	2-9
TRP® Disc Wheel Studs (Metric)	2-10
TRP® Wheel Studs with Shoulder	2-10
TRP® Assorted Wheel Studs	2-11
Headed Wheel Studs	2-11
Steering Wheel Studs	2-11
Wheel Flange Studs	2-11

TRP® North America

750 Houser Way N.
Renton, WA 98057

www.trpparts.com

Wheel Rim Studs	2-11
Wedge Head Wheel Studs	2-11
Metric Clipped Head Wheel Studs	2-11
SAE Clipped Head Wheel Studs	2-12

MERITOR WHEEL HARDWARE

Inner Cap Nuts	2-13
Dual Mounted Steel and Steel/Aluminum Wheels	2-13
Dual Mounted Aluminum Wheels	2-14
Wheel Nuts	2-15
Back Nuts (Grade C)	2-15
Flat Wheel Nuts	2-15
Disc Wheel Nuts	2-15
Cap Nuts - Single & Dual Mounted Wheels	2-15
Flanged Cap Nuts - Single & Dual Mounted Wheels	2-16
Flanged Cap Nuts	2-16
Cone Lock Nuts (2-Piece Flanged Nut)	2-17
Wheel Studs (SAE)	2-17
Front Wheel Studs	2-17
Front Wheel Studs - Aluminum Disc Wheels	2-18
Serrated Drive Axle Studs - .975"	2-19
Serrated Wheel Studs	2-19
Serrated Wheel Studs - .630"	2-22
Serrated Wheel Studs - .745"	2-22
Serrated Wheel Studs - .784"	2-22
Serrated Wheel Studs without Drum Shoulder - .784"	2-23
Serrated Wheel Studs with Drum Shoulder - .784"	2-24
Serrated Wheel Studs - .974"	2-25
Wheel Studs (Metric)	2-25
Metric Serrated Wheel Studs - .791" - M20x1.5-6G Thread	2-25

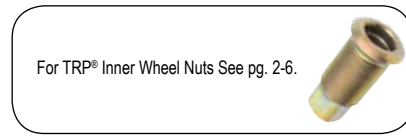
Metric Serrated Wheel Studs - .791" - M20x1.5 Thread	2-26
Metric Serrated Wheel Studs - .890"	2-26
Metric Serrated Wheel Studs - .901"	2-27
Metric Serrated Wheel Studs - .910"	2-27
Metric Serrated Wheel Studs - .975"	2-27
Metric Serrated Wheel Studs - M22x1.5 Thread	2-28
Drive Flange Studs	2-28
Drive Flange Studs - Grade 8	2-28
Drive Flange & General Purpose Studs - Grade 8	2-29
Drive Flange Wedges	2-30
Drive Flange Wedges (Plated)	2-30
Drive Flange Nuts	2-30
Drive Flange Nuts	2-30
Drum Bolt Assemblies	2-31
Drum Bolt Assemblies	2-31
Brake Drum Hardware	2-31
Brake Drum Attaching Screw	2-31
Rim Hardware	2-31
Spoke Wheel & Rim Studs- Grade 8	2-31
Spoke Wheel & Rim Studs- Grade 8 - Special Cases	2-32
Spoke Wheel & Rim Bolts	2-32
Rim Clamps	2-33

CROSS REFERENCE

Cross Reference for Wheels	2-38
Alcoa	2-38

WHEELS

STEEL WHEELS FROM ACCURIDE



For TRP® Inner Wheel Nuts See pg. 2-6.

Table 2-1: Steel Wheels from Accuride

Part Number	Description	Number of Holes	Mount	Hand Holes	Drop Center	Bolt Circle	Bore	Disc Thickness	Wheel Offset	Approx Wt (lbs)	Max Load (lbs)
-------------	-------------	-----------------	-------	------------	-------------	-------------	------	----------------	--------------	-----------------	----------------

19.5" STEEL WHEELS

29195BLK21	Disc Steel Wheel, 19.5" Diameter x 7.50" Width, Black	10	Hub-Piloted	5	15°	285.75mm	220mm	0.437"	6.40"	65	6700
29195PW	Disc Steel Wheel, 19.5" Diameter x 7.50" Width, White	10	Hub-Piloted	5	15°	285.75mm	220mm	0.437"	6.40"	65	6700

22.5" STEEL WHEELS

28869BLK21	Steel Wheel, 22.5" Diameter x 6.75" Width, E-Coat, Black	8	Hub-Piloted	4	5°	275mm	221mm	0.375"	5.70"	71	5000
28157PG	Steel Wheel, 22.5" Diameter x 6.75" Width, E-Coat, Grey	6	Stud-Piloted	6	15°	8.75"	6.50"	0.375"	5.94"	70	4610
29001BLK21	Steel Wheel, 22.5" Diameter x 7.50" Width, E-Coat, Black	10	Hub-Piloted	5	15°	285.75mm	220mm	0.437"	6.44"	72	6610
27403PW	Steel Wheel, 22.5" Diameter x 7.50" Width, E-Coat, White	10	Stud-Piloted	2	15°	11.25"	8.72"	0.437"	6.44"	73	6610
29001PW	Steel Wheel, 22.5" Diameter x 7.50" Width, E-Coat, White	10	Hub-Piloted	5	15°	285.75mm	220mm	0.437"	6.44"	72	6610
27404PW	Steel Wheel, 22.5" Diameter x 8.25" Width, E-Coat, White	10	Stud-Piloted	2	15°	11.25"	8.72"	0.437"	6.62"	78	7400
50408PW	Steel Wheel, 22.5" Diameter x 8.25" Width, E-Coat, White	10	Hub-Piloted	2	15°	285.75mm	220mm	0.437"	6.60"	70	7400
50487PW	Steel Wheel, 22.5" Diameter x 8.25" Width, E-Coat, White	10	Hub-Piloted	5	15°	285.75mm	220mm	0.437"	6.60"	68	7400
29300PW	Steel Wheel, 22.5" Diameter x 9.00" Width, E-Coat, White	10	Hub-Piloted	5	15°	285.75mm	220mm	0.625"	7.00"	108	9000
29001PKBLK21	Steel Wheel, 22.5" Diameter x 7.50" Width, Powder Top-coat, Black	10	Hub-Piloted	5	15°	285.75mm	220mm	0.437"	6.44"	72	6610
29001PKWHT21	Steel Wheel, 22.5" Diameter x 7.50" Width, Powder Top-coat, White	10	Hub-Piloted	5	15°	285.75mm	220mm	0.437"	6.44"	72	6610
27404PKBLK21	Steel Wheel, 22.5" Diameter x 8.25" Width, Powder Top-coat, Black	10	Stud-Piloted	2	15°	11.25"	8.72"	0.437"	6.62"	78	7400
28440PKBLK21	Steel Wheel, 22.5" Diameter x 8.25" Width, Powder Top-coat, Black	10	Hub-Piloted	10	15°	335mm	281mm	0.433"	6.62"	87	7500
50408BLK21	Steel Wheel, 22.5" Diameter x 8.25" Width, Powder Top-coat, Black	10	Hub-Piloted	2	15°	285.75mm	220mm	0.437"	6.60"	70	7400
50487PKBLK21	Steel Wheel, 22.5" Diameter x 8.25" Width, Powder Top-coat, Black	10	Hub-Piloted	5	15°	285.75mm	220mm	0.437"	6.60"	68	7400

Part Number	Description	Number of Holes	Mount	Hand Holes	Drop Center	Bolt Circle	Bore	Disc Thickness	Wheel Offset	Approx Wt (lbs)	Max Load (lbs)
28440PKWHT21	Steel Wheel, 22.5" Diameter x 8.25" Width, Powder Top-coat, White	10	Hub-Piloted	10	15°	335mm	281mm	0.433"	6.62"	87	7500
50408PKWHT21	Steel Wheel, 22.5" Diameter x 8.25" Width, Powder Top-coat, White	10	Hub-Piloted	2	15°	285.75mm	220mm	0.437"	6.60"	70	7400
27404PKYEL21	Steel Wheel, 22.5" Diameter x 8.25" Width, Powder Top-coat, Yellow	10	Stud-Piloted	2	15°	11.25"	8.72"	0.437"	6.62"	78	7400
50408PKYEL21	Steel Wheel, 22.5" Diameter x 8.25" Width, Powder Top-coat, Yellow	10	Hub-Piloted	2	15°	285.75mm	220mm	0.437"	6.60"	70	7400
50487PKWHT21	Steel Wheel, 22.5" Diameter x 8.25" Width, Machined Finish, White	10	Hub-Piloted	5	15°	285.75mm	220mm	0.437"	6.60"	68	7400
29300PKBLK21	Steel Wheel, 22.5" Diameter x 9.00" Width, Powder Top-coat, Black	10	Hub-Piloted	5	15°	285.75mm	220mm	0.625"	7.00"	108	9000
29300PKWHT21	Steel Wheel, 22.5" Diameter x 9.00" Width, Powder Top-coat, White	10	Hub-Piloted	5	15°	285.75mm	220mm	0.625"	7.00"	108	9000

ALUMINUM WHEELS FROM ACCURIDE

Table 2-2: Aluminum Wheels from Accuride

Part Number	Description	Number of Holes	Mount	Hand Holes	Drop Center	Bolt Circle	Bore	Disc Thickness	Wheel Offset	Approx Wt (lbs)	Max Load (lbs)
40008ANP	Aluminum Wheel, 22.5" Diameter x 8.25" Width, Machined Finish	10	Hub-Piloted	10	15°	285.75mm	220mm	0.935"	6.59"	54	8000
41644ANP	Aluminum Wheel, 22.5" Diameter x 8.25" Width, Enhanced Finish	10	Hub-Piloted	10	15°	285.75mm	220mm	0.885"	6.59"	47	7390
40008A1P	Aluminum Wheel, 22.5" Diameter x 8.25" Width, Inside Polished	10	Hub-Piloted	10	15°	285.75mm	220mm	0.935"	6.59"	54	8000
40008A0P	Aluminum Wheel, 22.5" Diameter x 8.25" Width, Outside Polished	10	Hub-Piloted	10	15°	285.75mm	220mm	0.935"	6.59"	43	8000
41644XP	Aluminum Wheel, 22.5" Diameter x 8.25" Width, Ultra-Enhanced Finish	10	Hub-Piloted	10	15°	285.75mm	220mm	0.885"	6.59"	47	7390
41644XPC	Aluminum Wheel, 22.5" Diameter x 8.25" Width, Ultra-Enhanced Finish with Accu-Shield Protective Coating	10	Hub-Piloted	10	15°	285.75mm	220mm	0.885"	6.59"	47	7390

Information & Images provided by Accuride Corporation

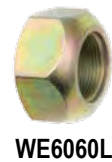
TRP® WHEEL HARDWARE



TRP® INNER WHEEL NUTS

Table 2-3: TRP® Inner Wheel Nuts

Part Number	Description	OEM	Type	Grade
WE7895L	Left Hand Wheel Nut I-3/4"-16 O-1-1/8"-16 x 2-1/4"	W12	LH	8
WE7896L	Left Hand Wheel Nut I-3/4"-16 O-1-1/8"-16 x 2-9/16"	W621	LH	8
WE5988L	Left Hand Wheel Nut I-3/4"-16 O-1-1/8"-16 x 3-1/16"	W487	LH	8
WE5978L	Left Hand Wheel Nut I-3/4"-16 O-1-1/8"-16 x 3-1/16"	W767	LH	8
WE7897L	Left Hand Wheel Nut I-3/4"-16 O-1-1/8"-16 x 3-1/16"	W617	LH	8
WE7898L	Left Hand Wheel Nut I-15/16"-12 O-1-5/16"-12 x 3"	W161	LH	8
WE7895R	Right Hand Wheel Nut I-3/4"-16 O-1-1/8"-16 x 2-1/4"	W11	RH	8
WE7896R	Right Hand Wheel Nut I-3/4"-16 O-1-1/8"-16 x 2-9/16"	W620	RH	8
WE5988R	Right Hand Wheel Nut I-3/4"-16 O-1-1/8"-16 x 3-1/16"	W486	RH	8
WE5978R	Right Hand Wheel Nut I-3/4"-16 O-1-1/8"-16 x 3-1/16"	W766	RH	8
WE7897R	Right Hand Wheel Nut I-3/4"-16 O-1-1/8"-16 x 3-1/16"	W616	RH	8
WE7898R	Right Hand Wheel Nut I-15/16"-12 O-1-5/16"-12 x 3"	W160	RH	8



TRP® OUTER WHEEL NUTS

Table 2-4: TRP® Outer Wheel Nuts

Part Number	Description	OEM	Type	Grade	Hex
WE5652L	Left Hand Outer Wheel Nut 3/4"-16	W16	Outer Wheel LH	5	1-1/2"
WE5996L	Left Hand Outer Wheel Nut 1-1/8"-16	W509	Outer Wheel LH	8	1-1/2"
WE5977L	Left Hand Outer Wheel Nut 1-1/8"-16	W14	Outer Wheel LH	8	1-1/2"
WE6060L	Left Hand Outer Wheel Nut 1-1/8"-16	W427	Outer Wheel LH	8	1-3/4"
WE5652R	Right Hand Outer Wheel Nut 3/4"-16	W15	Outer Wheel RH	5	1-1/2"
WE5996R	Right Hand Outer Wheel Nut 1-1/8"-16	W508	Outer Wheel RH	8	1-1/2"
WE5977R	Right Hand Outer Wheel Nut 1-1/8"-16	W13	Outer Wheel RH	8	1-1/2"
WE6060R	Right Hand Outer Wheel Nut 1-1/8"-16	W426	Outer Wheel RH	8	1-3/4"



TRP® OUTER DISC WHEEL NUTS

Table 2-5: TRP® Outer Disc Wheel Nuts

Part Number	Description	OEM	Type	Grade	Hex
WE5995L	Left Hand Outer Disc Wheel Nut 3/4"-16	W507	Outer Disc Wheel	8	1-1/2"
WE5554L	Left Hand Outer Disc Wheel Nut 3/4"-16	W123	Outer Disc Wheel	8	1-1/2"
WE5576L	Left Hand Outer Disc Wheel Nut 1-5/16"-12	W155	Outer Disc Wheel	8	1-3/4"
WE5995R	Right Hand Outer Disc Wheel Nut 3/4"-16	W506	Outer Disc Wheel	8	1-1/2"
WE5554R	Right Hand Outer Disc Wheel Nut 3/4"-16	W122	Outer Disc Wheel	8	1-1/2"
WE5576R	Right Hand Outer Disc Wheel Nut 1-5/16"-12	W154	Outer Disc Wheel	8	1-3/4"



TRP® ASSORTED WHEEL NUTS

Table 2-6: TRP® Assorted Wheel Nuts

Part Number	Description	OEM	Type	Grade	Hex
WE6000	Wheel Nut with Flange M22-1.5	W498	Flange	8	1-3/10"
WE5991	Wheel Nut with Flange M22-1.5	W492	Flange	10.9	1-1/2"
WE9020	Wheel Nut with Flange M22-1.5	W525	Flange	8	1-3/10"

WHEEL RIM NUTS

WE4963	Wheel Rim Nut 3/4"-10	W8	Rim nut	5	1-1/4"
--------	-----------------------	----	---------	---	--------



TRP® WHEEL STUDS (SAE)

Table 2-7: TRP® Wheel Studs (SAE)

Part Number	Description	OEM	Type	Grade	Body Diameter
WE1320L	Left Hand Wheel Stud 3/4"-16 x 2-3/8"	W753	Wheel LH	8	.786 - .783"
WE8949L	Left Hand Wheel Stud 3/4"-16 x 2-19/32"	W505	Wheel LH	8	.786 - .783"
WE4966L	Left Hand Wheel Stud 3/4"-16 x 2-5/8"	W67	Wheel LH	8	.786 - .783"
WE8983L	Left Hand Wheel Stud 3/4"-16 x 2-11/16"	W681	Wheel LH	8	.786 - .783"
WE5870L	Left Hand Wheel Stud 3/4"-16 x 2-7/8"	W69, W71	Wheel LH	8	.786 - .783"

Part Number	Description	OEM	Type	Grade	Body Diameter
WE8969L	Left Hand Wheel Stud 3/4"-16 x 2-15/16"	W609	Wheel LH	8	.786 - .783"
WE8947L	Left Hand Wheel Stud 3/4"-16 x 2-31/32"	W576	Wheel LH	8	.786 - .783"
WE5871L	Left Hand Wheel Stud 3/4"-16 x 3-1/8"	W275	Wheel LH	8	.976 - .971"
WE4969L	Left Hand Wheel Stud 3/4"-16 x 3-1/8"	W73	Wheel LH	8	.786 - .783"
WE1339L	Left Hand Wheel Stud 3/4"-16 x 3-1/8"	W755	Wheel LH	8	.786 - .783"
WE10209L	Left Hand Wheel Stud 3/4"-16 x 3-5/32"	W729	Wheel LH	8	.787 - .783"
WE8979L	Left Hand Wheel Stud 3/4"-16 x 3-3/8"	W611	Wheel LH	8	.786 - .783"
WE10208L	Left Hand Wheel Stud 3/4"-16 x 3-13/32"	W707	Wheel LH	8	.787 - .783"
WE10210L	Left Hand Wheel Stud 3/4"-16 x 3-25/32"	W731	Wheel LH	8	.787 - .783"
WE5766L	Left Hand Wheel Stud 3/4"-16 x 3-7/8"	W281	Wheel LH	8	.786 - .783"
WE5722L	Left Hand Wheel Stud 3/4"-16 x 4"	W371	Wheel LH	8	.976 - .971"
WE10227L	Left Hand Wheel Stud 1-1/8"-16 x 3-3/32"	W775	Wheel LH	8	1.225-1.221"
WE1090L	Left Hand Wheel Stud 1-1/8"-16 x 3-9/32"	W751	Wheel LH	8	1.222-1.218"
WE10228L	Left Hand Wheel Stud 1-1/8"-16 x 3-9/16"	W757	Wheel LH	8	1.225-1.221"
WE8985L	Left Hand Wheel Stud 1-1/8"-16 x 3-13/16"	W711	Wheel LH	8	1.222-1.218"
WE10225L	Left Hand Wheel Stud 1-1/8"-16 x 3-7/8"	W663	Wheel LH	8	1.225-1.221"
WE1320R	Right Hand Wheel Stud 3/4"-16 x 2-3/8"	W752	Wheel RH	8	.786 - .783"
WE8949R	Right Hand Wheel Stud 3/4"-16 x 2-19/32"	W504	Wheel RH	8	.786 - .783"
WE4966R	Right Hand Wheel Stud 3/4"-16 x 2-5/8"	W66	Wheel RH	8	.786 - .783"
WE8983R	Right Hand Wheel Stud 3/4"-16 x 2-11/16"	W680	Wheel RH	8	.786 - .783"
WE5870R	Right Hand Wheel Stud 3/4"-16 x 2-7/8"	W68, W70	Wheel RH	8	.786 - .783"
WE8969R	Right Hand Wheel Stud 3/4"-16 x 2-15/16"	W608	Wheel RH	8	.786 - .783"
WE8947R	Right Hand Wheel Stud 3/4"-16 x 2-31/32"	W575	Wheel RH	8	.786 - .783"
WE5871R	Right Hand Wheel Stud 3/4"-16 x 3-1/8"	W274	Wheel RH	8	.976 - .971"
WE4969R	Right Hand Wheel Stud 3/4"-16 x 3-1/8"	W72	Wheel RH	8	.786 - .783"
WE1339R	Right Hand Wheel Stud 3/4"-16 x 3-1/8"	W754	Wheel RH	8	.786 - .783"
WE10209R	Right Hand Wheel Stud 3/4"-16 x 3-5/32"	W728	Wheel RH	8	.787 - .783"
WE8979R	Right Hand Wheel Stud 3/4"-16 x 3-3/8"	W610	Wheel RH	8	.786 - .783"
WE10208R	Right Hand Wheel Stud 3/4"-16 x 3-13/32"	W706	Wheel RH	8	.787 - .783"
WE10210R	Right Hand Wheel Stud 3/4"-16 x 3-25/32"	W730	Wheel RH	8	.787 - .783"
WE5766R	Right Hand Wheel Stud 3/4"-16 x 3-7/8"	W280	Wheel RH	8	.786 - .783"
WE5722R	Right Hand Wheel Stud 3/4"-16 x 4"	W370	Wheel RH	8	.976 - .971"
WE10227R	Right Hand Wheel Stud 1-1/8"-16 x 3-3/32"	W774	Wheel RH	8	1.225-1.221"
WE1090R	Right Hand Wheel Stud 1-1/8"-16 x 3-9/32"	W750	Wheel RH	8	1.222-1.218"
WE10228R	Right Hand Wheel Stud 1-1/8"-16 x 3-9/16"	W756	Wheel RH	8	1.225-1.221"
WE10225R	Right Hand Wheel Stud 1-1/8"-16 x 3-7/8"	W662	Wheel RH	8	1.225-1.221"
WE8985R	Right Hand Wheel Stud 1-1/8"-16 x 3-13/16"	W710	Wheel RH	8	1.222-1.218"



TRP® WHEEL STUDS (METRIC)

Table 2-8: TRP® Wheel Studs (Metric)

Part Number	Description	OEM	Type	Grade	Body Diameter
WE6035	Metric Wheel Stud M22-1.5 x 3-15/16"	W545	Wheel	10.9	.977-.973"
WE6036	Metric Wheel Stud M22-1.5 x 3-1/2"	W544	Wheel	10.9	.977-.973"
WE10222	Metric Wheel Stud M22-1.5 x 3-21/32"	W772	Wheel	10.9	.912-.908"
WE10675	Metric Wheel Stud M22-1.5 x 3-23/32"	W678	Wheel	10.9	.975-.971"
WE1202	Metric Wheel Stud M22-1.5 x 3-29/32"	W683	Wheel	10.9	1.222-1.218"
WE10218	Metric Wheel Stud M22-1.5 x 3-31/32"	W703	Wheel	10.9	.912-.908"
WE8981	Metric Wheel Stud M22-1.5 x 4"	W657	Wheel	10.9	.975-.971"
WE10215	Metric Wheel Stud M22-1.5 x 4-3/32"	W716	Wheel	10.9	.912-.908"
WE10223	Metric Wheel Stud M22-1.5 x 4-5/32"	W771	Wheel	10.9	.912-.908"
WE10676	Metric Wheel Stud M22-1.5 x 4-1/4"	W669	Wheel	10.9	.975-.971"
WE10219	Metric Wheel Stud M22-1.5 x 4-1/2"	W708	Wheel	10.9	.912-.908"
WE1270	Metric Wheel Stud M22-1.5 x 4-1/2"	W715	Wheel	10.9	.975-.971"
WE12016	Metric Wheel Stud M22-1.5 x 4-9/16"	W717	Wheel	10.9	.912-.908"
WE6034	Metric Wheel Stud M22-1.5 x 4-13/16"	W546	Wheel	10.9	.977-.973"
WE10217	Metric Wheel Stud M22-1.5 x 4-15/16"	W718	Wheel	10.9	.912-.908"
WE10220	Metric Wheel Stud M22-1.5 x 5"	W719	Wheel	10.9	.912-.908"
WE8987	Metric Wheel Stud M22-1.5 x 5-3/16"	W688	Wheel	10.9	.975-.971"
WE10221	Metric Wheel Stud M22-1.5 x 5-5/16"	W702	Wheel	10.9	.912-.908"



TRP® DISC WHEEL STUDS (SAE)

Table 2-9: TRP® Disc Wheel Studs (SAE)

Part Number	Description	OEM	Type	Grade	Body Diameter
WE5719L	Left Hand Disc Wheel Stud 3/4"-16 x 2-9/16"	W171	Disc Wheel LH	8	.984 - .974"
WE5900L	Left Hand Disc Wheel Stud 3/4"-16 x 2-11/16"	W400	Disc Wheel LH	8	.976 - .971"
WE5720L	Left Hand Disc Wheel Stud 3/4"-16 x 2-23/32"	W167	Disc Wheel LH	8	.984 - .974"
WE10206L	Left Hand Disc Wheel Stud 3/4"-16 x 3"	W649	Disc Wheel LH	8	.786 - .783"
WE5910L	Left Hand Disc Wheel Stud 3/4"-16 x 3-1/8"	W396	Disc Wheel LH	8	.976 - .971"
WE8968L	Left Hand Disc Wheel Stud 3/4"-16 x 3-3/16"	W675	Disc Wheel LH	8	.786 - .783"
WE5896L	Left Hand Disc Wheel Stud 3/4"-16 x 3-3/8"	W277	Disc Wheel LH	8	.975 - .971"
WE5983L	Left Hand Disc Wheel Stud 3/4"-16 x 3-3/4"	W476	Disc Wheel LH	8	.975 - .971"
WE5986L	Left Hand Disc Wheel Stud 1-1/8"-16 x 2-31/32"	W521	Disc Wheel LH	8	1.222-1.218"

Part Number	Description	OEM	Type	Grade	Body Diameter
WE9001L	Left Hand Disc Wheel Stud 1-1/8"-16 x 3-15/32"	W331	Disc Wheel LH	8	1.222-1.218"
WE8972L	Left Hand Disc Wheel Stud 1-1/8"-16 x 3-1/2"	W511	Disc Wheel LH	8	1.222-1.218"
WE5982L	Left Hand Disc Wheel Stud 1-1/8"-16 x 3-3/4"	W478	Disc Wheel LH	8	1.222-1.218"
WE8990L	Left Hand Disc Wheel Stud 1-1/8"-16 x 4"	W551	Disc Wheel LH	8	1.222-1.218"
WE5719R	Right Hand Disc Wheel Stud 3/4"-16 x 2-9/16"	W170	Disc Wheel RH	8	.984 - .974"
WE5900R	Right Hand Disc Wheel Stud 3/4"-16 x 2-11/16"	W399	Disc Wheel RH	8	.976 - .971"
WE5720R	Right Hand Disc Wheel Stud 3/4"-16 x 2-23/32"	W166	Disc Wheel RH	8	.984 - .974"
WE10206R	Right Hand Disc Wheel Stud 3/4"-16 x 3"	W648	Disc Wheel RH	8	.786 - .783"
WE5910R	Right Hand Disc Wheel Stud 3/4"-16 x 3-1/8"	W395	Disc Wheel RH	8	.976 - .971"
WE8968R	Right Hand Disc Wheel Stud 3/4"-16 x 3-3/16"	W674	Disc Wheel RH	8	.786 - .783"
WE5896R	Right Hand Disc Wheel Stud 3/4"-16 x 3-3/8"	W276	Disc Wheel RH	8	.975 - .971"
WE5983R	Right Hand Disc Wheel Stud 3/4"-16 x 3-3/4"	W475	Disc Wheel RH	8	.975 - .971"
WE5986R	Right Hand Disc Wheel Stud 1-1/8"-16 x 2-31/32"	W750	Disc Wheel RH	8	1.222-1.218"
WE9001R	Right Hand Disc Wheel Stud 1-1/8"-16 x 3-15/32"	W330	Disc Wheel RH	8	1.222-1.218"
WE8972R	Right Hand Disc Wheel Stud 1-1/8"-16 x 3-1/2"	W510	Disc Wheel RH	8	1.222-1.218"
WE5982R	Right Hand Disc Wheel Stud 1-1/8"-16 x 3-3/4"	W477	Disc Wheel RH	8	1.222-1.218"
WE8990R	Right Hand Disc Wheel Stud 1-1/8"-16 x 4"	W550	Disc Wheel RH	8	1.222-1.218"

TRP® Disc Wheel Studs (Metric)

Table 2-10: TRP® Disc Wheel Studs (Metric)

Part Number	Description	OEM	Type	Grade	Body Diameter
WE5998	Metric Disc Wheel Stud M22-1.5 x 3-3/16"	W496	Disc Wheel	10.9	.910-.899"
WE5997	Metric Disc Wheel Stud M22-1.5 x 3-11/16"	W497	Disc Wheel	10.9	.910-.899"
WE5999	Metric Disc Wheel Stud M22-1.5 x 4-7/16"	W495	Disc Wheel	10.9	.910-.899"



TRP® Wheel Studs with Shoulder

Table 2-11: TRP® Wheel Studs with Shoulder

Part Number	Description	OEM	Type	Grade	Body Diameter
WE5556L	Left Hand Wheel Stud with Shoulder 3/4"-16 x 3-19/32"	W39	Shoulder	8	.786 - .783"
WE5559L	Left Hand Wheel Stud with Shoulder 3/4 -16 x 3-23/32"	W41	Shoulder	8	.786 - .783"
WE5561L	Left Hand Wheel Stud with Shoulder 3/4 -16 x 3-31/32"	W43	Shoulder	8	.786 - .783"
WE5560L	Left Hand Wheel Stud with Shoulder 3/4 -16 x 4-1/32"	W45	Shoulder	8	.786 - .783"
WE5989L	Left Hand Wheel Stud with Shoulder 3/4"-16 x 4-15/16"	W501	Shoulder	8	.786 - .783"

Part Number	Description	OEM	Type	Grade	Body Diameter
WE8976L	Left Hand Wheel Stud with Shoulder Hub End 3/4"-16 x 3-5/8"	W641	Shoulder	8	1.222-1.218"
WE5556R	Right Hand Wheel Stud with Shoulder 3/4"-16 x 3-19/32"	W38	Shoulder	8	.786 - .783"
WE5559R	Right Hand Wheel Stud with Shoulder 3/4"-16 x 3-23/32"	W40	Shoulder	8	.786 - .783"
WE5561R	Right Hand Wheel Stud with Shoulder 3/4"-16 x 3-31/32"	W42	Shoulder	8	.786 - .783"
WE5560R	Right Hand Wheel Stud with Shoulder 3/4"-16 x 4-1/32"	W44	Shoulder	8	.786 - .783"
WE5989R	Right Hand Wheel Stud with Shoulder 3/4"-16 x 4-15/16"	W500	Shoulder	8	.786 - .783"
WE8976R	Right Hand Wheel Stud with Shoulder Hub End 3/4"-16 x 3-5/8"	W640	Shoulder	8	1.222-1.218"



TRP® Assorted Wheel Studs

Table 2-12: TRP® Assorted Wheel Studs

Part Number	Description	OEM	Type	Grade	Body Diameter
-------------	-------------	-----	------	-------	---------------

HEADED WHEEL STUDS

WE2193	Left Hand Headed Wheel Stud 3/4"-16 x 3-1/32"	W727	Headed	8	.787 - .783"
--------	---	------	--------	---	--------------

STEERING WHEEL STUDS

WE10226L	Left Hand Steering Wheel Stud 3-13/32" x 1-1/2" x 1-31/32"	W779	Steering Stud LH	8	n/a
WE10226R	Right Hand Steering Wheel Stud 3-13/32" x 1-1/2" x 1-31/32"	W778	Steering Stud RH	8	n/a

WHEEL FLANGE STUDS

WE5872	Wheel Flange Stud 5/8"-11 x 3-11/16"	L1529	Flange Stud	8	n/a
WE3122	Wheel Flange Stud 5/8"-11 x 1-3/8" - 5/8-18 x 1-5/16"	L3122	Flange Stud	8	n/a

WHEEL RIM STUDS

WE4956	Wheel Rim Stud 3/4"-10 x 2-13/16" (1" & 1-9/16")	W6	Rim stud	8	n/a
--------	--	----	----------	---	-----

WEDGE HEAD WHEEL STUDS

WE5924L	Left Hand Wedge Head Wheel Stud 3/4"-16 x 3-3/8"	W265	Wedge head	8	.789 - .786"
WE5924R	Right Hand Wedge Head Wheel Stud 3/4"-16 x 3-3/8"	W264	Wedge head	8	.789 - .786"

METRIC CLIPPED HEAD WHEEL STUDS

WE6030	Metric Wheel Clipped Head Stud M22 -1.5 x 5-1/4"	W524	Clipped head	10.9	.912-.908"
WE6001	Metric Wheel Clipped Head Stud M22-1.5 x 4-15/16"	W547	Clipped head	10.9	.912-.908"






Part Number	Description	OEM	Type	Grade	Body Diameter
SAE CLIPPED HEAD WHEEL STUDS					
WE6058L	Left Hand Wheel Clipped Head Stud 3/4"-16 x 3-1/4"	W527	Clipped head	8	.786 - .783"
WE6027L	Left Hand Wheel Clipped Head Stud 3/4"-16 x 3-3/8"	W543	Clipped head	8	.786 - .783"
WE6059L	Left Hand Wheel Clipped Head Stud 3/4"-16 x 3-1/2"	W529	Clipped head	8	.786 - .783"
WE6058R	Right Hand Wheel Clipped Head Stud 3/4"-16 x 3-1/4"	W526	Clipped head	8	.786 - .783"
WE6027R	Right Hand Wheel Clipped Head Stud 3/4"-16 x 3-3/8"	W542	Clipped head	8	.786 - .783"
WE6059R	Right Hand Wheel Clipped Head Stud 3/4"-16 x 3-1/2"	W528	Clipped head	8	.786 - .783"

MERITOR WHEEL HARDWARE



INNER CAP NUTS

Table 2-13: Wheel Hardware - Steel/Aluminum Wheels

Product	Part Number	Description	Outer Overall Length	Outer Thread Size	Inner Thread Size	Inner Thread Min. Depth	Comments
DUAL MOUNTED STEEL AND STEEL/ALUMINUM WHEELS							
 O.E. STANDARD FOR DUAL STEEL WHEELS	R007895L	OE Standard for Dual Steel Wheels	2-1/4"	1-1/8"-16	3/4"-16	1-1/4"	Through hardened. Zinc dichromate plating.
 O.E. STANDARD FOR STEEL INNER AND ALUMINUM OUTER WHEELS	R007897L	OE Standard for Steel Inner and Aluminum Outer Wheels	3-1/16"	1-1/8"-16	3/4"-16	1-7/8"	Through hardened.
 O.E. STANDARD FOR STEEL INNER AND ALUMINUM OUTER WHEELS	R007896L	OE Standard for Steel Inner and Aluminum Outer Wheels	2-9/16"	1-1/8"-16	3/4"-16	1-1/4"	Through hardened.
 O.E. STANDARD FOR OFF-HIGHWAY APPLICATIONS	R007898L	OE Standard for Off-Highway Applications	3"	1-5/16"-12	15/16"-12	1-7/8"	Through hardened. Zinc dichromate plating.
	R007898R	OE Standard for Off-Highway Applications	3"	1-5/16"-12	15/16"-12	1-7/8"	Through hardened. Zinc dichromate plating.
 O.E. STANDARD FOR DUAL STEEL WHEELS	R007895R	OE Standard for Dual Steel Wheels	2-1/4"	1-1/8"-16	3/4"-16	1-1/4"	Through hardened. Zinc dichromate plating.

Zinc Clear Chromate plating unless otherwise stated.

Information & Images Provided by Meritor







Product	Part Number	Description	Outer Overall Length	Outer Thread Size	Inner Thread Size	Inner Thread Min. Depth	Comments
 <p>O.E. STANDARD FOR STEEL INNER AND ALUMINUM OUTER WHEELS</p>	R007896R	OE Standard for Steel Inner and Aluminum Outer Wheels	2-9/16"	1-1/8"-16	3/4"-16	1-1/4"	Through hardened.
 <p>O.E. STANDARD FOR STEEL INNER AND ALUMINUM OUTER WHEELS</p>	R007897R	OE Standard for Steel Inner and Aluminum Outer Wheels	3-1/16"	1-1/8"-16	3/4"-16	1-7/8"	Through hardened.

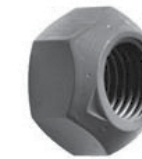
Table 2-14: Wheel Hardware - Aluminum Wheels

Product	Part Number	Description	Outer Overall Length	Outer Thread Size	Inner Thread Size	Inner Thread Min. Depth	Comments
---------	-------------	-------------	----------------------	-------------------	-------------------	-------------------------	----------

DUAL MOUNTED ALUMINUM WHEELS

 <p>O.E. STANDARD FOR DUAL ALUMINUM WHEEL APPLICATION</p>	R005988L	OE Standard for Dual Aluminum Wheel Application	3-3/32"	1-1/8"-16	3/4"-16	1-15/16"	Through hardened. 1/4" x 13/16" counterbore.
 <p>O.E. STANDARD WITH FULL INNER THREADS FOR APPLICATIONS REQUIRING MAXIMUM THREAD ENGAGEMENT</p>	R005978L	OE Standard with Full Inner Threads for Applications requiring maximum thread engagement	3-3/32"	1-1/8"-16	3/4"-16	1-15/16"	Through hardened.
 <p>O.E. STANDARD WITH FULL INNER THREADS FOR APPLICATIONS REQUIRING MAXIMUM THREAD ENGAGEMENT</p>	R005978R	OE Standard with Full Inner Threads for Applications requiring maximum thread engagement	3-3/32"	1-1/8"-16	3/4"-16	1-15/16"	Through hardened.
 <p>O.E. STANDARD FOR DUAL ALUMINUM WHEEL APPLICATION</p>	R005988R	OE Standard for Dual Aluminum Wheel Application	3-3/32"	1-1/8"-16	3/4"-16	1-15/16"	Through hardened. 1/4" x 13/16" counterbore.

Zinc Clear Chromate plating unless otherwise stated.
Information & Images Provided by Meritor



R004961A

For TRP® Inner Wheel Nuts See pg. 2-6.

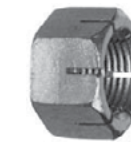


WHEEL NUTS

Table 2-15: Back Nuts (Grade C)

Part Number	Description	Thread	Hex	Height	Comments
R004961A	Back Nut (Grade C)	3/4"-16	1-1/8"	5/8"	Heat treated.
R301835	Back Nut (Grade C)	7/8"-14	1-1/4"	49/64"	Heat treated.
R001828	Back Nut (Grade C)	1"-14	1-1/2"	7/8"	Heat treated.

BACK NUTS (GRADE C)



R005007



R004962

Table 2-16: Flat Wheel Nuts

Part Number	Description	Thread	Hex	Height	Comments
-------------	-------------	--------	-----	--------	----------

FLAT WHEEL NUTS

R005007	Flat Wheel Nut	1/2"-20	7/8"	1/2"	
R004962	Flat Wheel Nut	5/8"-11	1-1/16"	5/8"	Flat face 2 sides. Grade 5
R005008	Flat Wheel Nut	5/8"-18	15/16"	23/32"	
R004963	Flat Wheel Nut	3/4"-10	1-1/4"	3/4"	Flat face 2 sides. Grade 5
R007775	Flat Wheel Nut	3/4"-10	1-1/4"	3/4"	Flat face 2 sides. Grade 8



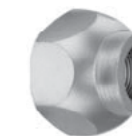
R004976R



R005625L



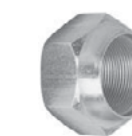
R005554L



R005995L



R004976R



R0010254L



R005977L

DISC WHEEL NUTS

Table 2-17: Cap Nuts for Single & Dual Mounted Wheels

Part Number	Description	Thread	Hex	Height	Comments
R004976R	Cap Nut for Single & Dual Mounted Wheels	9/16"-18	1"	11/16"	
R009012L	Cap Nut for Single & Dual Mounted Wheels	9/16"-18	1-1/16"	21/32"	
R009012R	Cap Nut for Single & Dual Mounted Wheels	9/16"-18	1-1/16"	21/32"	

CAP NUTS - SINGLE & DUAL MOUNTED WHEELS

Part Number	Description	Thread	Hex	Height	Comments
R004979R	Cap Nut for Single & Dual Mounted Wheels	5/8"-18	1"	5/8"	
R004975R	Cap Nut for Single & Dual Mounted Wheels	5/8"-18	1"	11/16"	
R005652L	Cap Nut for Single & Dual Mounted Wheels	3/4"-16	1-1/2"	7/8"	Zinc dichromate plating.
R005652R	Cap Nut for Single & Dual Mounted Wheels	3/4"-16	1-1/2"	7/8"	Zinc dichromate plating.
R005554L	Cap Nut for Single & Dual Mounted Wheels	3/4"-16	1-1/2"	1"	
R005554R	Cap Nut for Single & Dual Mounted Wheels	3/4"-16	1-1/2"	1"	
R005995L	Cap Nut for Single & Dual Mounted Wheels	3/4"-16	1-1/2"	1-3/8"	
R005995R	Cap Nut for Single & Dual Mounted Wheels	3/4"-16	1-1/2"		
R005977L	Cap Nut for Single & Dual Mounted Wheels	1-1/8"-16	1-1/2"	7/8"	Through hardened. Zinc dichromate plating.
R005977R	Cap Nut for Single & Dual Mounted Wheels	1-1/8"-16	1-1/2"	7/8"	Through hardened. Zinc dichromate plating.
R005996L	Cap Nut for Single & Dual Mounted Wheels	1-1/8"-16	1-1/2"	1"	
R005996R	Cap Nut for Single & Dual Mounted Wheels	1-1/8"-16	1-1/2"	1"	
R0010254L	Cap Nut for Single & Dual Mounted Wheels	M30x1.5	41mm	1"	For use with R003130L metric inner cap nut.
R0010254R	Cap Nut for Single & Dual Mounted Wheels	M30x1.5	41mm	1"	For use with R003130R metric inner cap nut.

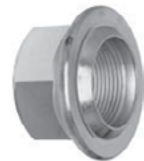


Table 2-18: Flanged Cap Nuts for Single & Dual Mounted Wheels

Part Number	Description	Thread	Hex	Height	Comments
-------------	-------------	--------	-----	--------	----------

FLANGED CAP NUTS - SINGLE & DUAL MOUNTED WHEELS

R005579L	Flanged Cap Nut for Single & Dual Mounted Wheels	1-1/8"-16	1-1/2"	1-7/64"	2" Flange dia.
R005579R	Flanged Cap Nut for Single & Dual Mounted Wheels	1-1/8"-16	1-1/2"	1-7/64"	2" Flange dia.



R0010234



R009021



R0005991



R006000A

Table 2-19: Flanged Cap Nuts

Part Number	Description	Thread	Hex	Height	Comments
-------------	-------------	--------	-----	--------	----------

FLANGED CAP NUTS

R0010234	Flanged Cap Nut	9/16"-18	1-1/16"	1-31/32"	2 pc. flanged nut.
R005892	Flanged Cap Nut	9/16"-18	7/8"	5/8"	1-7/32" Flange dia. 1 pc. flanged nut.
R009022R	Flanged Cap Nut	5/8"-18	1-1/8"	1-1/16"	Dodge and Navistar. 1-5/8" Flange dia. 1 pc. flanged nut.

Part Number	Description	Thread	Hex	Height	Comments
R005734	Flanged Cap Nut	11/16"-16	1-1/8"	1-1/16"	1 pc. flanged nut. Use R005683 stud on front. Use R005682 stud on rear.
R005704	Flanged Cap Nut	3/4"-16	1-1/8"	1-1/16"	2 pc. flanged nut. Use with R005703 stud.
R009021	Flanged Cap Nut	7/8"-14	1-5/16" (33mm)	7/8" (22mm)	General Motors Bus. 1-13/16" (46mm) Flange dia. 2 pc. flanged nut.
R0010235	Flanged Cap Nut	M20x1.5	1-3/16" (30mm)	1-1/16" (27mm)	Teflon coated. 2 pc. flanged nut.
R005991	Flanged Cap Nut	M22x1.5	1-1/2" (38.1mm)	1-3/8" (35mm)	2" (51mm) Flange dia. For motor wheel WHD-8 (8 Stud). Hub piloted wheel system. 2 pc. flanged nut.
R006000A	Flanged Cap Nut	M22x1.5	1-9/32" (33mm)	1-7/32" (31mm)	Teflon Coated For Budd Uni-Mount-10 (10 Stud) Hub Piloted Wheel . 1-13/16" (46mm) Flange dia. 2 pc. flanged nut.
R009020	Flanged Cap Nut	M22x1.5	1-9/32" (33mm)	1-1/32" (26mm)	Alcoa hub piloted wheels. 1-13/16" (46mm) Flange dia. 2 pc. flanged nut.



Table 2-20: Cone Lock Nuts (2-Piece Flanged Nut)

Part Number	Description	Thread	Hex	Height	Comments
-------------	-------------	--------	-----	--------	----------

CONE LOCK NUTS (2-PIECE FLANGED NUT)

R005708	Cone Lock Nuts (2-Piece Flanged Nut)	3/4"-16	1-3/16"	1-1/8"	1-3/4" Flange dia.
R005710	Cone Lock Nuts (2-Piece Flanged Nut)	7/8"-14	1-1/2"	29/32"	2" Flange dia.
R005711	Cone Lock Nuts (2-Piece Flanged Nut)	7/8"-14	1-1/2"	1-3/8"	2" Flange dia.



WHEEL STUDS (SAE)

Table 2-21: Front Wheel Studs - Stud Body Diameter 1.220"

Part Number	Description	Length	Body Length	Thread Length	Serration Length
-------------	-------------	--------	-------------	---------------	------------------

FRONT WHEEL STUDS

R005750L	Front Wheel Stud - Grade 8 - 1-1/8" - 16 Thread - Body Diameter 1.220"	3"	1-3/8"	1-5/8"	1"
R005750R	Front Wheel Stud - Grade 8 - 1-1/8" - 16 Thread - Body Diameter 1.220"	3"	1-3/8"	1-5/8"	1"
R005899L	Front Wheel Stud - Grade 8 - 1-1/8" - 16 Thread - Body Diameter 1.220"	3-5/32"	1-5/16"	1-17/32"	3/8"
R005899R	Front Wheel Stud - Grade 8 - 1-1/8" - 16 Thread - Body Diameter 1.220"	3-5/32"	1-5/16"	1-17/32"	3/8"
R005898L	Front Wheel Stud - Grade 8 - 1-1/8" - 16 Thread - Body Diameter 1.220"	3-3/16"	1-3/8"	1-13/16"	1"
R005898R	Front Wheel Stud - Grade 8 - 1-1/8" - 16 Thread - Body Diameter 1.220"	3-3/16"	1-3/8"	1-13/16"	1"
R008996L	Front Wheel Stud - Grade 8 - 1-1/8" - 16 Thread - Body Diameter 1.220"	3-1/4"	3/4"	2-1/4"	9/16"
R008996R	Front Wheel Stud - Grade 8 - 1-1/8" - 16 Thread - Body Diameter 1.220"	3-1/4"	3/4"	2-1/4"	9/16"
R009001L	Front Wheel Stud - Grade 8 - 1-1/8" - 16 Thread - Body Diameter 1.220"	3-15/32"	7/8"	1-29/64"	7/16"
R009001R	Front Wheel Stud - Grade 8 - 1-1/8" - 16 Thread - Body Diameter 1.220"	3-15/32"	7/8"	1-29/64"	7/16"

Part Number	Description	Length	Body Length	Thread Length	Serration Length
R008972L	Front Wheel Stud - Grade 8 - 1-1/8" - 16 Thread - Body Diameter 1.220"	3-1/2"	1-3/16"	2-1/32"	3/4"
R008972R	Front Wheel Stud - Grade 8 - 1-1/8" - 16 Thread - Body Diameter 1.220"	3-1/2"	1-3/16"	2-1/32"	3/4"
R008966L	Front Wheel Stud - Grade 8 - 1-1/8" - 16 Thread - Body Diameter 1.220"	3-9/16"	1-9/16"	1-23/32"	1/2"
R008966R	Front Wheel Stud - Grade 8 - 1-1/8" - 16 Thread - Body Diameter 1.220"	3-9/16"	1-9/16"	1-23/32"	1/2"
R008995L	Front Wheel Stud - Grade 8 - 1-1/8" - 16 Thread - Body Diameter 1.220"	3-9/16"	1-7/16"	1-3/4"	1-1/16"
R008995R	Front Wheel Stud - Grade 8 - 1-1/8" - 16 Thread - Body Diameter 1.220"	3-9/16"	1-7/16"	1-3/4"	1-1/16"
R005868L	Front Wheel Stud - Grade 8 - 1-1/8" - 16 Thread - Body Diameter 1.220"	3-5/8"	1-13/16"	1-13/16"	3/4"
R005868R	Front Wheel Stud - Grade 8 - 1-1/8" - 16 Thread - Body Diameter 1.220"	3-5/8"	1-13/16"	1-13/16"	3/4"
R008985L	Front Wheel Stud - Grade 8 - 1-1/8" - 16 Thread - Body Diameter 1.220"	3-13/16"	1-3/16"	2-1/2"	3/4"
R008985R	Front Wheel Stud - Grade 8 - 1-1/8" - 16 Thread - Body Diameter 1.220"	3-13/16"	1-3/16"	2-1/2"	3/4"
R008990L	Front Wheel Stud - Grade 8 - 1-1/8" - 16 Thread - Body Diameter 1.220"	4"	1-5/16"	1-13/16"	3/4"



Table 2-22: Front Wheel Studs - Stud Body Diameter 1.220" for Aluminum Disc Wheels

Part Number	Description	Length	Body Length	Thread Length	Serration Length
-------------	-------------	--------	-------------	---------------	------------------

FRONT WHEEL STUDS - ALUMINUM DISC WHEELS

R008990R	Front Wheel Stud - Grade 8 - 1-1/8" - 16 Thread - Body Diameter 1.220" for Aluminum Disc Wheels	4"	1-5/16"	1-13/16"	3/4"
R001607L	Front Wheel Stud - Grade 8 - 1-1/8" - 16 Thread - Body Diameter 1.220" for Aluminum Disc Wheels	2-29/32"	1-3/8"	1-7/32"	1"
R001607R	Front Wheel Stud - Grade 8 - 1-1/8" - 16 Thread - Body Diameter 1.220" for Aluminum Disc Wheels	2-29/32"	1-3/8"	1-7/32"	1"
R0010227L	Front Wheel Stud - Grade 8 - 1-1/8" - 16 Thread - Body Diameter 1.220" for Aluminum Disc Wheels	3-3/32"	1-5/32"	1-15/32"	1/2"
R0010227R	Front Wheel Stud - Grade 8 - 1-1/8" - 16 Thread - Body Diameter 1.220" for Aluminum Disc Wheels	3-3/32"	1-5/32"	1-15/32"	1/2"
R0010226L	Front Wheel Stud - Grade 8 - 1-1/8" - 16 Thread - Body Diameter 1.220" for Aluminum Disc Wheels	3-13/32"	1-17/32"	1-15/32"	1/2"
R0010226R	Front Wheel Stud - Grade 8 - 1-1/8" - 16 Thread - Body Diameter 1.220" for Aluminum Disc Wheels	3-13/32"	1-17/32"	1-15/32"	1/2"
R0010228L	Front Wheel Stud - Grade 8 - 1-1/8" - 16 Thread - Body Diameter 1.220" for Aluminum Disc Wheels	3-9/16"	1-5/32"	1-15/16"	1/2"
R0010228R	Front Wheel Stud - Grade 8 - 1-1/8" - 16 Thread - Body Diameter 1.220" for Aluminum Disc Wheels	3-9/16"	1-5/32"	1-15/16"	1/2"
R001623L	Front Wheel Stud - Grade 8 - 1-1/8" - 16 Thread - Body Diameter 1.220" for Aluminum Disc Wheels	3-3/4"	1-3/8"	2-1/2"	7/16"
R001623R	Front Wheel Stud - Grade 8 - 1-1/8" - 16 Thread - Body Diameter 1.220" for Aluminum Disc Wheels	3-3/4"	1-3/8"	2-1/2"	7/16"

Information & Images Provided by Meritor

Part Number	Description	Length	Body Length	Thread Length	Serration Length
R005982L	Front Wheel Stud - Grade 8 - 1-1/8" - 16 Thread - Body Diameter 1.220" for Aluminum Disc Wheels	3-3/4"	1-7/32"	2-1/4"	9/16"
R005982R	Front Wheel Stud - Grade 8 - 1-1/8" - 16 Thread - Body Diameter 1.220" for Aluminum Disc Wheels	3-3/4"	1-7/32"	2-1/4"	9/16"
R005985L	Front Wheel Stud - Grade 8 - 1-1/8" - 16 Thread - Body Diameter 1.220" for Aluminum Disc Wheels	3-25/32"	1-3/8"	1-7/16"	1"
R005985R	Front Wheel Stud - Grade 8 - 1-1/8" - 16 Thread - Body Diameter 1.220" for Aluminum Disc Wheels	3-25/32"	1-3/8"	1-7/16"	1"
R0010225L	Front Wheel Stud - Grade 8 - 1-1/8" - 16 Thread - Body Diameter 1.220" for Aluminum Disc Wheels	3-7/8"	1-17/32"	1-29/32"	1/2"
R0010225R	Front Wheel Stud - Grade 8 - 1-1/8" - 16 Thread - Body Diameter 1.220" for Aluminum Disc Wheels	3-7/8"	1-17/32"	1-29/32"	1/2"

Information & Images Provided by Meritor

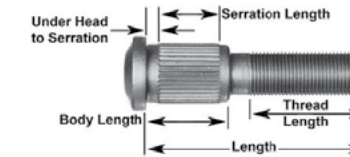
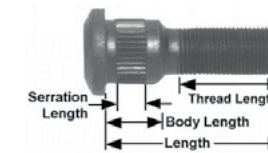


Table 2-23: Drive Axle Stud - Stud Body Diameter .975" For Aluminum Disc Wheels

Part Number	Description	Length	Body Length	Thread Length	Under Head to Serration	Serration Length
-------------	-------------	--------	-------------	---------------	-------------------------	------------------

SERRATED DRIVE AXLE STUDS - .975"

R005983L	Serrated Drive Axle Stud - Grade 8 - 3/4" -16 Thread - Stud Body Diameter .975" For Aluminum Disc Wheels	3-3/8"	1-3/8"	2-1/4"	1/4"	1"
R005983R	Serrated Drive Axle Stud - Grade 8 - 3/4" -16 Thread - Stud Body Diameter .975" For Aluminum Disc Wheels	3-3/8"	1-3/8"	2-1/4"	1/4"	1"



09-002048

Table 2-24: Serrated Wheel Studs - Grade 8 - 3/4" -16 Thread

Part Number	Description	Thread Direction	Length	Body Length	Body Diameter "A"	Body Diameter "B"
-------------	-------------	------------------	--------	-------------	-------------------	-------------------

SERRATED WHEEL STUDS

09-002048	Serrated Wheel Stud - Grade 8 - 3/4" - 16 Thread	LH	2-1/8"	11/16"	7/8"	1-1/4"
09-002047	Serrated Wheel Stud - Grade 8 - 3/4" - 16 Thread	RH	2-1/8"	11/16"	7/8"	1-1/4"
R009011L	Serrated Wheel Stud - Grade 8 - 3/4" - 16 Thread	LH	2-3/8"	7/8"	25/32"	1-1/16"
R009011R	Serrated Wheel Stud - Grade 8 - 3/4" - 16 Thread	RH	2-3/8"	7/8"	1-25/32"	1-1/16"
09-869702	Serrated Wheel Stud - Grade 8 - 3/4" - 16 Thread	LH	2-3/8"	1"	1-25/32"	1-1/16"
09-869701	Serrated Wheel Stud - Grade 8 - 3/4" - 16 Thread	RH	2-3/8"	1"	1-25/32"	1-1/16"
09-002211	Serrated Wheel Stud - Grade 8 - 3/4" - 16 Thread	LH	2-27/64"	1"	7/8"	1-1/4"

Information & Images Provided by Meritor

Part Number	Description	Thread Direction	Length	Body Length	Body Diameter "A"	Body Diameter "B"
09-002210	Serrated Wheel Stud - Grade 8 - 3/4" - 16 Thread	RH	2-27/64"	1"	7/8"	1-1/4"
R005911L	Serrated Wheel Stud - Grade 8 - 3/4" - 16 Thread	LH	2-9/16"	15/16"	31/32"	1-1/4"
R005911R	Serrated Wheel Stud - Grade 8 - 3/4" - 16 Thread	RH	2-9/16"	15/16"	31/32"	1-1/4"
09-001255	Serrated Wheel Stud - Grade 8 - 3/4" - 16 Thread	LH	2-9/16"	1-5/64"	25/32"	1-1/4"
09-001254	Serrated Wheel Stud - Grade 8 - 3/4" - 16 Thread	RH	2-9/16"	1-5/64"	25/32"	1-1/4"
09-001966	Serrated Wheel Stud - Grade 8 - 3/4" - 16 Thread	LH	2-21/32"	7/8"	25/32"	1-11/32"
09-001965	Serrated Wheel Stud - Grade 8 - 3/4" - 16 Thread	RH	2-21/32"	7/8"	25/32"	1-11/32"
09-002205	Serrated Wheel Stud - Grade 8 - 3/4" - 16 Thread	LH	2-11/16"	1-1/8"	7/8"	1-3/8"
09-002204	Serrated Wheel Stud - Grade 8 - 3/4" - 16 Thread	RH	2-11/16"	1-1/8"	7/8"	1-3/8"
09-001651	Serrated Wheel Stud - Grade 8 - 3/4" - 16 Thread	LH	2-3/4"	1-3/8"	25/32"	1-13/64"
09-001650	Serrated Wheel Stud - Grade 8 - 3/4" - 16 Thread	RH	2-3/4"	1-3/8"	25/32"	1-13/64"
R005721L	Serrated Wheel Stud - Grade 8 - 3/4" - 16 Thread	LH	2-13/16"	1-3/16"	31/32"	1-3/16"
R005721R	Serrated Wheel Stud - Grade 8 - 3/4" - 16 Thread	RH	2-13/16"	1-3/16"	31/32"	1-3/16"
09-001653	Serrated Wheel Stud - Grade 8 - 3/4" - 16 Thread	LH	2-7/8"	1"	25/32"	1-3/4"
09-001652	Serrated Wheel Stud - Grade 8 - 3/4" - 16 Thread	RH	2-7/8"	1"	25/32"	1-3/4"
R008958L	Serrated Wheel Stud - Grade 8 - 3/4" - 16 Thread	LH	2-7/8"	1-1/2"	25/32"	1-3/16"
R008958R	Serrated Wheel Stud - Grade 8 - 3/4" - 16 Thread	RH	2-7/8"	1-1/2"	25/32"	1-3/16"
09-001615	Serrated Wheel Stud - Grade 8 - 3/4" - 16 Thread	LH	2-15/16"	1-1/16"	25/32"	1-3/4"
09-001614	Serrated Wheel Stud - Grade 8 - 3/4" - 16 Thread	RH	2-15/16"	1-1/16"	25/32"	1-3/4"
R005910L	Serrated Wheel Stud - Grade 8 - 3/4" - 16 Thread	LH	3-1/8"	13/16"	31/32"	1-5/16"
R005910R	Serrated Wheel Stud - Grade 8 - 3/4" - 16 Thread	RH	3-1/8"	13/16"	31/32"	1-5/16"
09-001540	Serrated Wheel Stud - Grade 8 - 3/4" - 16 Thread	LH	3-1/8"	1-21/32"	25/32"	1-5/16"
09-001539	Serrated Wheel Stud - Grade 8 - 3/4" - 16 Thread	RH	3-1/8"	1-21/32"	25/32"	1-5/16"
R009524L	Serrated Wheel Stud - Grade 8 - 3/4" - 16 Thread	LH	3-3/16"	25/32"	31/32"	1-19/32"
R009524R	Serrated Wheel Stud - Grade 8 - 3/4" - 16 Thread	RH	3-3/16"	25/32"	31/32"	1-19/32"
R009525L	Serrated Wheel Stud - Grade 8 - 3/4" - 16 Thread	LH	3-11/32"	25/32"	31/32"	1-27/32"
R009525R	Serrated Wheel Stud - Grade 8 - 3/4" - 16 Thread	RH	3-11/32"	25/32"	31/32"	1-27/32"
R005909L	Serrated Wheel Stud - Grade 8 - 3/4" - 16 Thread	LH	3-11/32"	1-13/16"	31/32"	1-1/16"
R005909R	Serrated Wheel Stud - Grade 8 - 3/4" - 16 Thread	RH	3-11/32"	1-13/16"	31/32"	1-1/16"
09-001485	Serrated Wheel Stud - Grade 8 - 3/4" - 16 Thread	LH	3-3/8"	1-9/32"	25/32"	1-15/16"
09-001484	Serrated Wheel Stud - Grade 8 - 3/4" - 16 Thread	RH	3-3/8"	1-9/32"	25/32"	1-15/16"
R008978L	Serrated Wheel Stud - Grade 8 - 3/4" - 16 Thread	LH	3-13/32"	1-29/32"	25/32"	1-7/32"
R008978R	Serrated Wheel Stud - Grade 8 - 3/4" - 16 Thread	RH	3-13/32"	1-29/32"	25/32"	1-7/32"
R008957L	Serrated Wheel Stud - Grade 8 - 3/4" - 16 Thread	LH	3-1/2"	1-25/32"	25/32"	1-9/32"
R008957R	Serrated Wheel Stud - Grade 8 - 3/4" - 16 Thread	RH	3-1/2"	1-25/32"	25/32"	1-9/32"
09-001764	Serrated Wheel Stud - Grade 8 - 3/4" - 16 Thread	LH	3-27/32"	1-13/64"	31/32"	1-5/16"
09-001763	Serrated Wheel Stud - Grade 8 - 3/4" - 16 Thread	RH	3-27/32"	1-13/64"	31/32"	1-5/16"
R008954L	Serrated Wheel Stud - Grade 8 - 3/4" - 16 Thread	LH	3-27/32"	2-11/32"	25/32"	1-15/64"
R008954R	Serrated Wheel Stud - Grade 8 - 3/4" - 16 Thread	RH	3-27/32"	2-11/32"	25/32"	1-15/64"
R008977L	Serrated Wheel Stud - Grade 8 - 3/4" - 16 Thread	LH	3-7/8"	2-1/16"	25/32"	1-11/16"

Information & Images Provided by Meritor

Part Number	Description	Thread Direction	Length	Body Length	Body Diameter "A"	Body Diameter "B"
R008977R	Serrated Wheel Stud - Grade 8 - 3/4" - 16 Thread	RH	3-7/8"	2-1/16"	25/32"	1-11/16"
R005722L	Serrated Wheel Stud - Grade 8 - 3/4" - 16 Thread	LH	4"	2-7/16"	31/32"	1-3/16"
R005722R	Serrated Wheel Stud - Grade 8 - 3/4" - 16 Thread	RH	4"	2-7/16"	31/32"	1-3/16"
09-001998	Serrated Wheel Stud - Grade 8 - 3/4" - 16 Thread	LH	2-3/8"	57/64"	0.89"	0.94"
09-001997	Serrated Wheel Stud - Grade 8 - 3/4" - 16 Thread	RH	2-3/8"	57/64"	0.89"	0.94"
09-001983	Serrated Wheel Stud - Grade 8 - 3/4" - 16 Thread	LH	2-3/8"	1"	0.89"	0.939"
09-001982	Serrated Wheel Stud - Grade 8 - 3/4" - 16 Thread	RH	2-3/8"	1"	0.89"	0.939"
09-001556	Serrated Wheel Stud - Grade 8 - 3/4" - 16 Thread	LH	2-3/8"	1-3/32"	0.875"	0.975"
09-001555	Serrated Wheel Stud - Grade 8 - 3/4" - 16 Thread	RH	2-3/8"	1-3/32"	0.875"	0.975"
09-002050	Serrated Wheel Stud - Grade 8 - 3/4" - 16 Thread	LH	2-3/8"	1-1/8"	0.89"	0.94"
09-002049	Serrated Wheel Stud - Grade 8 - 3/4" - 16 Thread	RH	2-3/8"	1-1/8"	0.89"	0.94"
09-001526	Serrated Wheel Stud - Grade 8 - 3/4" - 16 Thread	LH	2-35/64"	1-9/64"	0.78"	0.79"
09-001525	Serrated Wheel Stud - Grade 8 - 3/4" - 16 Thread	RH	2-35/64"	1-9/64"	0.78"	0.79"
09-001992	Serrated Wheel Stud - Grade 8 - 3/4" - 16 Thread	LH	2-5/8"	57/64"	0.89"	0.939"
09-001991	Serrated Wheel Stud - Grade 8 - 3/4" - 16 Thread	RH	2-5/8"	57/64"	0.89"	0.939"
09-001911	Serrated Wheel Stud - Grade 8 - 3/4" - 16 Thread	LH	2-5/8"	1-1/64"	0.89"	0.939"
09-001910	Serrated Wheel Stud - Grade 8 - 3/4" - 16 Thread	RH	2-5/8"	1-1/64"	0.89"	0.939"
09-002086	Serrated Wheel Stud - Grade 8 - 3/4" - 16 Thread	LH	2-49/64"	7/8"	0.89"	0.939"
09-002085	Serrated Wheel Stud - Grade 8 - 3/4" - 16 Thread	RH	2-49/64"	7/8"	0.89"	0.939"
09-001985	Serrated Wheel Stud - Grade 8 - 3/4" - 16 Thread	LH	2-53/64"	1"	0.89"	0.939"
09-001984	Serrated Wheel Stud - Grade 8 - 3/4" - 16 Thread	RH	2-53/64"	1"	0.89"	0.939"
R009003L	Serrated Wheel Stud - Grade 8 - 3/4" - 16 Thread	LH	2-57/64"	1-5/16"	0.779"	0.779"
R009003R	Serrated Wheel Stud - Grade 8 - 3/4" - 16 Thread	RH	2-57/64"	1-5/16"	0.779"	0.779"
R008947L	Serrated Wheel Stud - Grade 8 - 3/4" - 16 Thread	LH	2-31/32"	1-3/8"	0.777"	0.784"
R008947R	Serrated Wheel Stud - Grade 8 - 3/4" - 16 Thread	RH	2-31/32"	1-3/8"	0.777"	0.784"
09-001996	Serrated Wheel Stud - Grade 8 - 3/4" - 16 Thread	LH	3-3/64"	57/64"	0.89"	0.939"
09-001995	Serrated Wheel Stud - Grade 8 - 3/4" - 16 Thread	RH	3-3/64"	57/64"	0.89"	0.939"
R009008L	Serrated Wheel Stud - Grade 8 - 3/4" - 16 Thread	LH	3-3/8"	1-13/32"	0.786"	0.786"
R009008R	Serrated Wheel Stud - Grade 8 - 3/4" - 16 Thread	RH	3-3/8"	1-13/32"	0.786"	0.786"

Information & Images Provided by Meritor

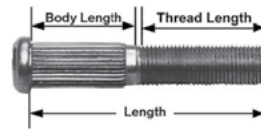


Table 2-25: Serrated Wheel Studs - Stud Body Diameter .630"

Part Number	Description	Length	Body Length	Thread Length
SERRATED WHEEL STUDS - .630"				
R0010229	Serrated Wheel Stud - Grade 8 - 5/8" - 18 Thread - Stud Body Diameter .630"	2-15/16"	3/4"	1-1/4"
R001905	Serrated Wheel Stud - Grade 8 - 5/8" - 18 Thread - Stud Body Diameter .630"	3-3/16"	1"	1-1/2"

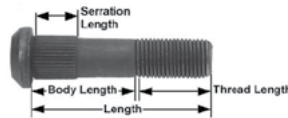


Table 2-26: Serrated Wheel Studs - Stud Body Diameter .745"

Part Number	Description	Length	Body Length	Thread Length	Under Head to Serration	Serration Length
SERRATED WHEEL STUDS - .745"						
R008994L	Serrated Wheel Stud - Grade 8 - 3/4" - 16 Thread - Stud Body Diameter .745"	2-1/2"	1-5/32"	1-1/4"	29/32"	29/32"
R008994R	Serrated Wheel Stud - Grade 8 - 3/4" - 16 Thread - Stud Body Diameter .745"	2-1/2"	1-5/32"	1-1/4"	29/32"	29/32"
R008992L	Serrated Wheel Stud - Grade 8 - 3/4" - 16 Thread - Stud Body Diameter .745"	2-31/32"	1-19/32"	1-3/16"	15/16"	15/16"
R008992R	Serrated Wheel Stud - Grade 8 - 3/4" - 16 Thread - Stud Body Diameter .745"	2-31/32"	1-19/32"	1-3/16"	15/16"	15/16"
R008993L	Serrated Wheel Stud - Grade 8 - 3/4" - 16 Thread - Stud Body Diameter .745"	3-1/4"	1-7/8"	1-5/32"	1-1/8"	1-1/8"
R008993R	Serrated Wheel Stud - Grade 8 - 3/4" - 16 Thread - Stud Body Diameter .745"	3-1/4"	1-7/8"	1-5/32"	1-1/8"	1-1/8"

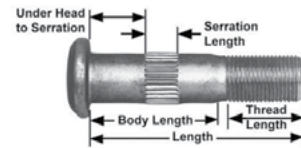


Table 2-27: Serrated Wheel Studs - Stud Body Diameter .784"

Part Number	Description	Length	Body Length	Thread Length	Under Head to Serration	Serration Length
SERRATED WHEEL STUDS - .784"						
R0010202L	Serrated Wheel Stud - Grade 8 - 3/4" -16 Thread - Stud Body Diameter .784"	2-1/2"	3/4"	1-1/2"	5/32"	1/2"
R0010202R	Serrated Wheel Stud - Grade 8 - 3/4" -16 Thread - Stud Body Diameter .784"	2-1/2"	3/4"	1-1/2"	5/32"	1/2"
R0010203L	Serrated Wheel Stud - Grade 8 - 3/4" -16 Thread - Stud Body Diameter .784"	2-33/64"	1-11/32"	1"	n/a	1/2"

Information & Images Provided by Meritor

Part Number	Description	Length	Body Length	Thread Length	Under Head to Serration	Serration Length
R0010203R	Serrated Wheel Stud - Grade 8 - 3/4" -16 Thread - Stud Body Diameter .784"	2-33/64"	1-11/32"	1"	n/a	1/2"
R008983L	Serrated Wheel Stud - Grade 8 - 3/4" -16 Thread - Stud Body Diameter .784"	2-11/16"	31/32"	1-11/32"	1/4"	1/2"
R008983R	Serrated Wheel Stud - Grade 8 - 3/4" -16 Thread - Stud Body Diameter .784"	2-11/16"	31/32"	1-11/32"	1/4"	1/2"
R008969L	Serrated Wheel Stud - Grade 8 - 3/4" -16 Thread - Stud Body Diameter .784"	2-15/16"	1-5/16"	1-13/32"	1/4"	1/2"
R008969R	Serrated Wheel Stud - Grade 8 - 3/4" -16 Thread - Stud Body Diameter .784"	2-15/16"	1-5/16"	1-13/32"	1/4"	1/2"
R0010206L	Serrated Wheel Stud - Grade 8 - 3/4" -16 Thread - Stud Body Diameter .784"	3"	1-21/32"	1-1/4"	1"	1/2"
R0010206R	Serrated Wheel Stud - Grade 8 - 3/4" -16 Thread - Stud Body Diameter .784"	3"	1-21/32"	1-1/4"	1"	1/2"
R008982L	Serrated Wheel Stud - Grade 8 - 3/4" -16 Thread - Stud Body Diameter .784"	3-1/8"	1-11/32"	1-19/32"	1/4"	1/2"
R008982R	Serrated Wheel Stud - Grade 8 - 3/4" -16 Thread - Stud Body Diameter .784"	3-1/8"	1-11/32"	1-19/32"	1/4"	1/2"
R0010209L	Serrated Wheel Stud - Grade 8 - 3/4" -16 Thread - Stud Body Diameter .784"	3-5/32"	1-7/16"	1-1/2"	1/8"	1/2"
R0010209R	Serrated Wheel Stud - Grade 8 - 3/4" -16 Thread - Stud Body Diameter .784"	3-5/32"	1-7/16"	1-1/2"	1/8"	1/2"
R008968L	Serrated Wheel Stud - Grade 8 - 3/4" -16 Thread - Stud Body Diameter .784"	3-3/16"	31/32"	1-5/8"	1/4"	1/2"
R008968R	Serrated Wheel Stud - Grade 8 - 3/4" -16 Thread - Stud Body Diameter .784"	3-3/16"	31/32"	1-5/8"	1/4"	1/2"
R001124L	Serrated Wheel Stud - Grade 8 - 3/4" -16 Thread - Stud Body Diameter .784"	3-1/4"	1-3/4"	1-3/8"	n/a	1/2"
R001124R	Serrated Wheel Stud - Grade 8 - 3/4" -16 Thread - Stud Body Diameter .784"	3-1/4"	1-3/4"	1-3/8"	n/a	1/2"
R0010208L	Serrated Wheel Stud - Grade 8 - 3/4" -16 Thread - Stud Body Diameter .784"	3-11/32"	1-7/16"	1-5/8"	1/8"	1/2"
R0010208R	Serrated Wheel Stud - Grade 8 - 3/4" -16 Thread - Stud Body Diameter .784"	3-11/32"	1-7/16"	1-5/8"	1/8"	1/2"
R008979L	Serrated Wheel Stud - Grade 8 - 3/4" -16 Thread - Stud Body Diameter .784"	3-11/32"	1-9/32"	1-27/32"	1/4"	1/2"
R008979R	Serrated Wheel Stud - Grade 8 - 3/4" -16 Thread - Stud Body Diameter .784"	3-11/32"	1-9/32"	1-27/32"	1/4"	1/2"
R0010210L	Serrated Wheel Stud - Grade 8 - 3/4" -16 Thread - Stud Body Diameter .784"	3-25/32"	1-7/16"	2"	1/8"	1/2"
R0010210R	Serrated Wheel Stud - Grade 8 - 3/4" -16 Thread - Stud Body Diameter .784"	3-25/32"	1-7/16"	2"	1/8"	1/2"

SERRATED WHEEL STUDS WITHOUT DRUM SHOULDER - .784"

R004964L	Serrated Wheel Stud - Grade 8 - 3/4" -16 Thread - Stud Body Diameter .784"	2-1/8"	3/4"	1-1/4"	1/4"	1/2"
R004964R	Serrated Wheel Stud - Grade 8 - 3/4" -16 Thread - Stud Body Diameter .784"	2-1/8"	3/4"	1-1/4"	1/4"	1/2"
R004965L	Serrated Wheel Stud - Grade 8 - 3/4" -16 Thread - Stud Body Diameter .784"	2-3/8"	1"	1-1/4"	1/4"	1/2"
R004965R	Serrated Wheel Stud - Grade 8 - 3/4" -16 Thread - Stud Body Diameter .784"	2-3/8"	1"	1-1/4"	1/4"	1/2"
R004966L	Serrated Wheel Stud - Grade 8 - 3/4" -16 Thread - Stud Body Diameter .784"	2-5/8"	1-1/4"	1-1/4"	5/16"	1/2"
R004966R	Serrated Wheel Stud - Grade 8 - 3/4" -16 Thread - Stud Body Diameter .784"	2-5/8"	1-1/4"	1-1/4"	5/16"	1/2"
R004967L	Serrated Wheel Stud - Grade 8 - 3/4" -16 Thread - Stud Body Diameter .784"	2-7/8"	1-1/2"	1-1/4"	1/4"	1/2"
R004967R	Serrated Wheel Stud - Grade 8 - 3/4" -16 Thread - Stud Body Diameter .784"	2-7/8"	1-1/2"	1-1/4"	1/4"	1/2"
R004968L	Serrated Wheel Stud - Grade 8 - 3/4" -16 Thread - Stud Body Diameter .784"	2-7/8"	1-1/2"	1-1/4"	1/2"	1/2"
R004968R	Serrated Wheel Stud - Grade 8 - 3/4" -16 Thread - Stud Body Diameter .784"	2-7/8"	1-1/2"	1-1/4"	1/2"	1/2"
R004969L	Serrated Wheel Stud - Grade 8 - 3/4" -16 Thread - Stud Body Diameter .784"	3-1/8"	1-3/4"	1-1/4"	9/16"	1/2"
R004969R	Serrated Wheel Stud - Grade 8 - 3/4" -16 Thread - Stud Body Diameter .784"	3-1/8"	1-3/4"	1-1/4"	9/16"	1/2"
R005869L	Serrated Wheel Stud - Grade 8 - 3/4" -16 Thread - Stud Body Diameter .784"	4-1/8"	2-3/4"	1-1/4"	9/16"	1/2"
R005869R	Serrated Wheel Stud - Grade 8 - 3/4" -16 Thread - Stud Body Diameter .784"	4-1/8"	2-3/4"	1-1/4"	9/16"	1/2"

Information & Images Provided by Meritor

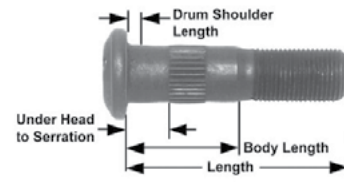


Table 2-28: Serrated Wheel Studs with Drum Shoulder - Stud Body Diameter .784"

Part Number	Description	Drum Shoulder Diameter	Drum Shoulder Length	Length	Body Length	Under Head to Serration
SERRATED WHEEL STUDS WITH DRUM SHOULDER - .784"						
R005764L	Serrated Wheel Stud with Drum Shoulder - Stud Body Diameter .784" - Grade 8 - 3/4" - 16 Thread	.798/.808	3/16"	2-3/8"	1"	3/8"
R005764R	Serrated Wheel Stud with Drum Shoulder - Stud Body Diameter .784" - Grade 8 - 3/4" - 16 Thread	.798/.808	3/16"	2-3/8"	1"	3/8"
R005870L	Serrated Wheel Stud with Drum Shoulder - Stud Body Diameter .784" - Grade 8 - 3/4" - 16 Thread	.798/.808	3/16"	2-5/8"	1-1/4"	7/16"
R005870R	Serrated Wheel Stud with Drum Shoulder - Stud Body Diameter .784" - Grade 8 - 3/4" - 16 Thread	.798/.808	3/16"	2-5/8"	1-1/4"	7/16"
R005775	Serrated Wheel Stud with Drum Shoulder - Stud Body Diameter .784" - Grade 8 - 3/4" - 16 Thread	.798/.808	1/4"	2-3/4"	1-3/8"	1/2"
R005776	Serrated Wheel Stud with Drum Shoulder - Stud Body Diameter .784" - Grade 8 - 3/4" - 16 Thread	.798/.808	5/16"	3"	1-9/16"	1/2"
R005756L	Serrated Wheel Stud with Drum Shoulder - Stud Body Diameter .784" - Grade 8 - 3/4" - 16 Thread	.798/.808	5/16"	3-3/8"	2"	9/16"
R005756R	Serrated Wheel Stud with Drum Shoulder - Stud Body Diameter .784" - Grade 8 - 3/4" - 16 Thread	.798/.808	5/16"	3-3/8"	2"	9/16"
R005765L	Serrated Wheel Stud with Drum Shoulder - Stud Body Diameter .784" - Grade 8 - 3/4" - 16 Thread	.798/.808	3/16"	3-3/8"	2"	3/8"
R005765R	Serrated Wheel Stud with Drum Shoulder - Stud Body Diameter .784" - Grade 8 - 3/4" - 16 Thread	.798/.808	3/16"	3-3/8"	2"	3/8"
R005757L	Serrated Wheel Stud with Drum Shoulder - Stud Body Diameter .784" - Grade 8 - 3/4" - 16 Thread	.798/.808	5/16"	3-5/8"	2-1/4"	9/16"
R005757R	Serrated Wheel Stud with Drum Shoulder - Stud Body Diameter .784" - Grade 8 - 3/4" - 16 Thread	.798/.808	5/16"	3-5/8"	2-1/4"	9/16"
R005766L	Serrated Wheel Stud with Drum Shoulder - Stud Body Diameter .784" - Grade 8 - 3/4" - 16 Thread	.798/.808	5/16"	3-7/8"	2-1/2"	9/16"
R005766R	Serrated Wheel Stud with Drum Shoulder - Stud Body Diameter .784" - Grade 8 - 3/4" - 16 Thread	.798/.808	5/16"	3-7/8"	2-1/2"	9/16"

Information & Images Provided by Meritor

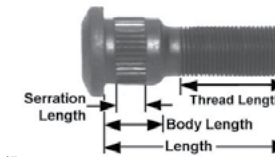
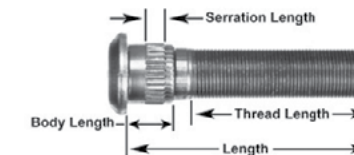


Table 2-29: Serrated Wheel Studs - Stud Body Diameter .974"

Part Number	Description	Length	Body Length	Thread Length	Serration Length
SERRATED WHEEL STUDS - .974"					
R005718L	Serrated Wheel Stud - Grade 8 - 3/4" -16 Thread - Stud Body Diameter .974"	2-13/32"	3/4"	1-1/8"	1/2"
R005718R	Serrated Wheel Stud - Grade 8 - 3/4" -16 Thread - Stud Body Diameter .974"	2-13/32"	3/4"	1-1/8"	1/2"
R005719L	Serrated Wheel Stud - Grade 8 - 3/4" -16 Thread - Stud Body Diameter .974"	2-19/32"	3/4"	1-9/32"	1/2"
R005719R	Serrated Wheel Stud - Grade 8 - 3/4" -16 Thread - Stud Body Diameter .974"	2-19/32"	3/4"	1-9/32"	1/2"
R005900L	Serrated Wheel Stud - Grade 8 - 3/4" -16 Thread - Stud Body Diameter .974"	2-11/16"	3/4"	1-5/8"	1/2"
R005900R	Serrated Wheel Stud - Grade 8 - 3/4" -16 Thread - Stud Body Diameter .974"	2-11/16"	3/4"	1-5/8"	1/2"
R005720L	Serrated Wheel Stud - Grade 8 - 3/4" -16 Thread - Stud Body Diameter .974"	2-3/4"	3/4"	1-15/32"	1/2"
R005720R	Serrated Wheel Stud - Grade 8 - 3/4" -16 Thread - Stud Body Diameter .974"	2-3/4"	3/4"	1-15/32"	1/2"
R005987L	Serrated Wheel Stud - Grade 8 - 3/4" -16 Thread - Stud Body Diameter .974"	2-15/16"	1-1/4"	1-1/4"	1"
R005987R	Serrated Wheel Stud - Grade 8 - 3/4" -16 Thread - Stud Body Diameter .974"	2-15/16"	1-1/4"	1-1/4"	1"
R005871L	Serrated Wheel Stud - Grade 8 - 3/4" -16 Thread - Stud Body Diameter .974"	3-1/8"	1-3/8"	1-1/4"	1"
R005871R	Serrated Wheel Stud - Grade 8 - 3/4" -16 Thread - Stud Body Diameter .974"	3-1/8"	1-3/8"	1-1/4"	1"
R006057L	Serrated Wheel Stud - Grade 8 - 3/4" -16 Thread - Stud Body Diameter .974"	3-3/16"	1-3/16"	1-5/32"	1"
R006057R	Serrated Wheel Stud - Grade 8 - 3/4" -16 Thread - Stud Body Diameter .974"	3-3/16"	1-3/16"	1-5/32"	1"
R005896L	Serrated Wheel Stud - Grade 8 - 3/4" -16 Thread - Stud Body Diameter .974"	3-3/8"	1-5/16"	1-1/4"	1"
R005896R	Serrated Wheel Stud - Grade 8 - 3/4" -16 Thread - Stud Body Diameter .974"	3-3/8"	1-5/16"	1-1/4"	1"



WHEEL STUDS (METRIC)

Table 2-30: Metric Serrated Wheel Studs - Stud Body Diameter .791" - M20x1.5-6G Thread

Part Number	Description	Length	Thread Length	Under Head to Serration	Serration Length
METRIC SERRATED WHEEL STUDS - .791" - M20x1.5-6G THREAD					
09-001853	Metric Serrated Wheel Stud - Stud Body Diameter .791" - Grade 10.9, M20x1.5-6G Thread	2-3/4"	2"	3/4"	3/8"
09-001990	Metric Serrated Wheel Stud - Stud Body Diameter .791" - Grade 10.9, M20x1.5-6G Thread	2-59/64"	2-11/64"	3/4"	3/8"
09-001811	Metric Serrated Wheel Stud - Stud Body Diameter .791" - Grade 10.9, M20x1.5-6G Thread	3-11/16"	2-27/64"	1-1/4"	3/8"
09-001855	Metric Serrated Wheel Stud - Stud Body Diameter .791" - Grade 10.9, M20x1.5-6G Thread	3-7/8"	2-5/8"	1-1/4"	3/8"
09-001964	Metric Serrated Wheel Stud - Stud Body Diameter .791" - Grade 10.9, M20x1.5-6G Thread	4-11/64"	2-59/64"	1-1/4"	3/8"

Information & Images Provided by Meritor

Table 2-31: Metric Serrated Wheel Studs - Stud Body Diameter .791" - M20x1.5 Thread

Part Number	Description	Length	Thread Length	Under Head to Serration	Serration Length
09-001853	Metric Serrated Wheel Stud - Stud Body Diameter .791" - Grade 10.9, M20x1.5 Thread	2-3/4"	2"	3/4"	3/8"
09-001990	Metric Serrated Wheel Stud - Stud Body Diameter .791" - Grade 10.9, M20x1.5 Thread	2-59/64"	2-11/64"	3/4"	3/8"
09-001811	Metric Serrated Wheel Stud - Stud Body Diameter .791" - Grade 10.9, M20x1.5 Thread	3-11/16"	2-27/64"	1-1/4"	3/8"
09-001855	Metric Serrated Wheel Stud - Stud Body Diameter .791" - Grade 10.9, M20x1.5 Thread	3-7/8"	2-5/8"	1-1/4"	3/8"
09-001964	Metric Serrated Wheel Stud - Stud Body Diameter .791" - Grade 10.9, M20x1.5 Thread	4-11/64"	2-59/64"	1-1/4"	3/8"

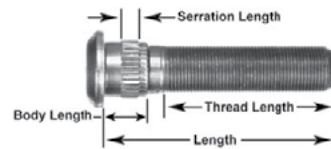


Table 2-32: Metric Serrated Wheel Studs - Stud Body Diameter .890"

Part Number	Description	Length	Thread Length	Under Head to Serration	Serration Length
09-001958	Metric Serrated Wheel Stud - Stud Body Diameter .890" - Grade 10.9, M22x1.5 Thread	2-3/4"	51/64"	1-21/32"	3/8"
09-002013	Metric Serrated Wheel Stud - Stud Body Diameter .890" - Grade 10.9, M22x1.5 Thread	2-13/16"	7/8"	1-11/16"	3/8"
09-001988	Metric Serrated Wheel Stud - Stud Body Diameter .890" - Grade 10.9, M22x1.5 Thread	3-11/32"	7/8"	2-15/64"	3/8"
09-002002	Metric Serrated Wheel Stud - Stud Body Diameter .890" - Grade 10.9, M22x1.5 Thread	3-39/64"	7/8"	2-43/64"	3/8"
09-001989	Metric Serrated Wheel Stud - Stud Body Diameter .890" - Grade 10.9, M22x1.5 Thread	3-23/32"	7/8"	2-9/16"	3/8"
09-002001	Metric Serrated Wheel Stud - Stud Body Diameter .890" - Grade 10.9, M22x1.5 Thread	3-27/32"	7/8"	2-11/16"	3/8"
09-002005	Metric Serrated Wheel Stud - Stud Body Diameter .890" - Grade 10.9, M22x1.5 Thread	3-27/32"	1-1/8"	2-5/8"	3/8"
09-001727	Metric Serrated Wheel Stud - Stud Body Diameter .890" - Grade 10.9, M22x1.5 Thread	3-7/8"	7/8"	2-3/4"	3/8"
09-002004	Metric Serrated Wheel Stud - Stud Body Diameter .890" - Grade 10.9, M22x1.5 Thread	4-11/64"	7/8"	3-1/64"	3/8"
09-001728	Metric Serrated Wheel Stud - Stud Body Diameter .890" - Grade 10.9, M22x1.5 Thread	4-5/16"	7/8"	3-3/16"	3/8"
09-002003	Metric Serrated Wheel Stud - Stud Body Diameter .890" - Grade 10.9, M22x1.5 Thread	4-25/32"	13/16"	3-27/32"	3/8"

Information & Images Provided by Meritor

Table 2-33: Metric Serrated Wheel Studs - Stud Body Diameter .901"

Part Number	Description	Length	Body Length	Thread Length	Serration Length
09-002184	Metric Serrated Wheel Stud - Stud Body Diameter .901" - Grade 10.9, M22x1.5 Thread	2-61/64"	7/8"	1-49/64"	3/8"
R005998	Metric Serrated Wheel Stud - Stud Body Diameter .901" - Grade 10.9, M22x1.5 Thread	3-3/16"	7/8"	2"	13/32"
R005997	Metric Serrated Wheel Stud - Stud Body Diameter .901" - Grade 10.9, M22x1.5 Thread	3-21/32"	7/8"	2-29/64"	13/32"
R005999	Metric Serrated Wheel Stud - Stud Body Diameter .901" - Grade 10.9, M22x1.5 Thread	4-9/16"	7/8"	3-13/32"	13/32"

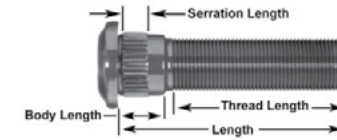


Table 2-34: Metric Serrated Wheel Studs - Stud Body Diameter .910"

Part Number	Description	Length	Body Length	Thread Length	Serration Length
R0010222	Metric Serrated Wheel Stud - Stud Body Diameter .910" - Grade 10.9, M22x1.5 Thread	3-21/32"	1-7/32"	2-3/32"	1/2"
R0010218	Metric Serrated Wheel Stud - Stud Body Diameter .910" - Grade 10.9, M22x1.5 Thread	3-31/32"	1-9/16"	2-1/16"	1/2"
R0010215	Metric Serrated Wheel Stud - Stud Body Diameter .910" - Grade 10.9, M22x1.5 Thread	4-3/32"	1-1/16"	2-11/32"	1/2"
R0010219	Metric Serrated Wheel Stud - Stud Body Diameter .910" - Grade 10.9, M22x1.5 Thread	4-15/32"	1-9/16"	2-9/16"	1/2"
R0010216	Metric Serrated Wheel Stud - Stud Body Diameter .910" - Grade 10.9, M22x1.5 Thread	4-19/32"	1-1/16"	2-27/32"	1/2"
R0010217	Metric Serrated Wheel Stud - Stud Body Diameter .910" - Grade 10.9, M22x1.5 Thread	4-31/32"	1-1/16"	3-7/32"	1/2"
R0010220	Metric Serrated Wheel Stud - Stud Body Diameter .910" - Grade 10.9, M22x1.5 Thread	4-31/32"	1-9/16"	3-1/16"	1/2"
R0010221	Metric Serrated Wheel Stud - Stud Body Diameter .910" - Grade 10.9, M22x1.5 Thread	5-11/32"	1-9/16"	3-7/16"	1/2"

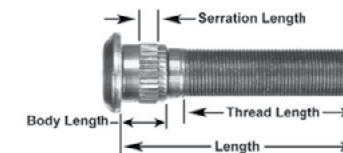


Table 2-35: Metric Serrated Wheel Studs - Stud Body Diameter .975"

Part Number	Description	Length	Body Length	Thread Length	Serration Length
R0010242	Metric Serrated Wheel Stud - Stud Body Diameter .975" - Grade 10.9, M20x1.5 Thread	2-29/32"	23/32"	1-21/32"	3/8"
R0010675	Metric Serrated Wheel Stud - Stud Body Diameter .975" - Grade 10.9, M20x1.5 Thread	3-1/2"	11/16"	2-1/2"	1/2"
R006036	Metric Serrated Wheel Stud - Stud Body Diameter .975" - Grade 10.9, M20x1.5 Thread	3-1/2"	23/32"	2-1/4"	3/8"

Information & Images Provided by Meritor

Part Number	Description	Length	Body Length	Thread Length	Serration Length
R008988	Metric Serrated Wheel Stud - Stud Body Diameter .975" - Grade 10.9, M20x1.5 Thread	3-11/16"	7/8"	2-11/32"	1/2"
R006035	Metric Serrated Wheel Stud - Stud Body Diameter .975" - Grade 10.9, M20x1.5 Thread	3-15/16"	23/32"	2-11/16"	3/8"
R008981	Metric Serrated Wheel Stud - Stud Body Diameter .975" - Grade 10.9, M20x1.5 Thread	4"	7/8"	2-29/32"	1/2"
R0010676	Metric Serrated Wheel Stud - Stud Body Diameter .975" - Grade 10.9, M20x1.5 Thread	4-1/4"	11/16"	3-1/4"	1/2"
R009526	Metric Serrated Wheel Stud - Stud Body Diameter .975" - Grade 10.9, M20x1.5 Thread	4-5/16"	23/32"	3-1/16"	3/8"
R006034	Metric Serrated Wheel Stud - Stud Body Diameter .975" - Grade 10.9, M20x1.5 Thread	4-13/16"	23/32"	3-17/32"	3/8"
R008980	Metric Serrated Wheel Stud - Stud Body Diameter .975" - Grade 10.9, M20x1.5 Thread	5-3/32"	7/8"	3-3/4"	1/2"
R008987	Metric Serrated Wheel Stud - Stud Body Diameter .975" - Grade 10.9, M20x1.5 Thread	5-3/16"	1-1/16"	3-23/32"	1/2"

Information & Images Provided by Meritor

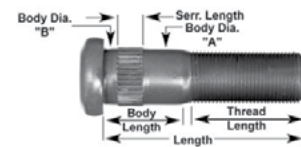


Table 2-36: Metric Serrated Wheel Studs - Grade 10.9, M22x1.5 Thread

Part Number	Description	Stud Body Diameter "A"	Stud Body Diameter "B"	Length	Body Length	Thread Length
R008960	Metric Serrated Wheel Stud - Grade 10.9, M22x1.5 Thread	0.982	1.02	3-7/16"	2"	1"

METRIC SERRATED WHEEL STUDS - M22x1.5 THREAD



DRIVE FLANGE STUDS

Table 2-37: Drive Flange Studs - Grade 8

Part Number	Description	Body Diameter	Length	Hub End Thread	Hub End Thread Length	Nut End Thread
R005796	Drive Flange Stud - Grade 8 - Budd, Dayton, Gunite, Meritor	7/16"	2-1/4"	7/16"-14	21/32"	7/16"-20
R005798	Drive Flange Stud - Grade 8 - Budd, Dayton, Gunite, Meritor	1/2"	2-3/8"	1/2"-13	3/4"	1/2"-20
R005799	Drive Flange Stud - Grade 8 - Budd, Dayton, Gunite, Meritor	1/2"	2-1/2"	1/2"-13	3/4"	1/2"-20
R005944	Drive Flange Stud - Grade 8 - Budd, Dayton, Gunite, Meritor	9/16"	2-1/2"	9/16"-12	15/16"	9/16"-18
08-205373	Drive Flange Stud - Grade 8 - Budd, Dayton, Gunite, Meritor	9/16"	2-1/2"	9/16"-12	1"	9/16"-18
R005946	Drive Flange Stud - Grade 8 - Budd, Dayton, Gunite, Meritor	5/8"	2-1/2"	5/8"-11	15/16"	5/8"-18
R005800	Drive Flange Stud - Grade 8 - Budd, Dayton, Gunite, Meritor	5/8"	2-3/4"	5/8"-11	1"	5/8"-18

Information & Images Provided by Meritor

Part Number	Description	Body Diameter	Length	Hub End Thread	Hub End Thread Length	Nut End Thread
08-205435	Drive Flange Stud - Grade 8 - Budd, Dayton, Gunite, Meritor	1/2"	2-7/8"	1/2"-13	53/64"	1/2"-20
R005947	Drive Flange Stud - Grade 8 - Budd, Dayton, Gunite, Meritor	5/8"	2-7/8"	5/8"-11	1"	5/8"-18
08-007591	Drive Flange Stud - Grade 8 - Budd, Dayton, Gunite, Meritor	5/8"	2-7/8"	5/8"-11	1-5/32"	5/8"-18
08-205575	Drive Flange Stud - Grade 8 - Budd, Dayton, Gunite, Meritor	9/16"	2-59/64"	9/16"-12	1-1/4"	9/16"-18
R005954	Drive Flange Stud - Grade 8 - Budd, Dayton, Gunite, Meritor	5/8"	2-15/16"	5/8"-11	13/16"	5/8"-18
08-205740	Drive Flange Stud - Grade 8 - Budd, Dayton, Gunite, Meritor	5/8"	2-15/16"	5/8"-11	55/64"	5/8"-11
08-205833	Drive Flange Stud - Grade 8 - Budd, Dayton, Gunite, Meritor	5/8"	3-1/32"	5/8"-11	31/32"	5/8"-18
08-205741	Drive Flange Stud - Grade 8 - Budd, Dayton, Gunite, Meritor	1/2"	3-1/32"	1/2"-13	1"	1/2"-13
R005801	Drive Flange Stud - Grade 8 - Budd, Dayton, Gunite, Meritor	5/8"	3-1/16"	5/8"-11	1-3/16"	5/8"-18
08-205967	Drive Flange Stud - Grade 8 - Budd, Dayton, Gunite, Meritor	5/8"	3-1/4"	5/8"-11	15/16"	5/8"-18
R005949	Drive Flange Stud - Grade 8 - Budd, Dayton, Gunite, Meritor	5/8"	3-1/4"	5/8"-11	15/16"	5/8"-18
R005955	Drive Flange Stud - Grade 8 - Budd, Dayton, Gunite, Meritor	3/4"	3-5/16"	3/4"-10	1-3/64"	3/4"-16
08-205879	Drive Flange Stud - Grade 8 - Budd, Dayton, Gunite, Meritor	3/4"	3-5/16"	3/4"-10	1-3/64"	3/4"-16
R005872	Drive Flange Stud - Grade 8 - Budd, Dayton, Gunite, Meritor	5/8"	3-11/16"	5/8"-11	1-9/16"	5/8"-18
R004960	Drive Flange Stud - Grade 8 - Budd, Dayton, Gunite, Meritor	3/4"	3-3/4"	3/4"-10	1-1/8"	3/4"-16

Information & Images Provided by Meritor

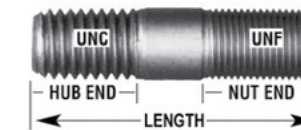
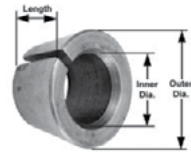


Table 2-38: Drive Flange & General Purpose Studs - Grade 8

Part Number	Description	Body Diameter	Length	Hub End Thread	Hub End Thread Length	Nut End Thread
R004942	Drive Flange & General Purpose Stud - Grade 8	1/2"	2"	1/2"-13	11/16"	1/2"-20
R004944	Drive Flange & General Purpose Stud - Grade 8	1/2"	2-1/2"	1/2"-13	3/4"	1/2"-20
R004948	Drive Flange & General Purpose Stud - Grade 8	9/16"	2-1/2"	9/16"-12	1"	9/16"-18
R004951	Drive Flange & General Purpose Stud - Grade 8	5/8"	2-5/8"	5/8"-11	15/16"	5/8"-18
R005702	Drive Flange & General Purpose Stud - Grade 8	5/8"	2-5/8"	5/8"-11	1-1/16"	5/8"-18
R004945	Drive Flange & General Purpose Stud - Grade 8	1/2"	2-3/4"	1/2"-13	3/4"	1/2"-20
R004949	Drive Flange & General Purpose Stud - Grade 8	9/16"	2-3/4"	9/16"-12	15/16"	9/16"-18
R004946	Drive Flange & General Purpose Stud - Grade 8	1/2"	3"	1/2"-13	11/16"	1/2"-20
R004952	Drive Flange & General Purpose Stud - Grade 8	5/8"	3"	5/8"-11	15/16"	5/8"-18
R004950	Drive Flange & General Purpose Stud - Grade 8	9/16"	3-1/4"	9/16"-12	15/16"	9/16"-18
R004947	Drive Flange & General Purpose Stud - Grade 8	1/2"	3-1/2"	1/2"-13	15/16"	1/2"-20
R004953	Drive Flange & General Purpose Stud - Grade 8	5/8"	3-1/2"	5/8"-11	13/16"	5/8"-18

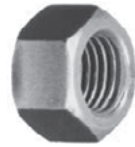
Information & Images Provided by Meritor



DRIVE FLANGE WEDGES

Table 2-39: Drive Flange Wedges (Plated)

Part Number	Description	Inner Diameter	Outer Diameter	Length	Note
DRIVE FLANGE WEDGES (PLATED)					
R005952	Drive Flange Wedge (Plated)	7/16"	11/16"	13/32"	
R005736	Drive Flange Wedge (Plated)	7/16"	3/4"	5/16"	
R005737	Drive Flange Wedge (Plated)	7/16"	3/4"	13/32"	Solid wedge - no split.
R005738	Drive Flange Wedge (Plated)	7/16"	13/16"	11/32"	
R005739	Drive Flange Wedge (Plated)	1/2"	13/16"	5/16"	
R005740	Drive Flange Wedge (Plated)	1/2"	13/16"	13/32"	Solid wedge - no split.
R005957	Drive Flange Wedge (Plated)	1/2"	7/8"	15/32"	
R005742	Drive Flange Wedge (Plated)	9/16"	7/8"	3/8"	
R005743	Drive Flange Wedge (Plated)	5/8"	1"	15/32"	
R005960	Drive Flange Wedge (Plated)	5/8"	1"	9/16"	Solid wedge - no split.
R007224	Drive Flange Wedge (Plated)	3/4"	1-1/8"	1/2"	

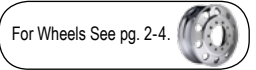


DRIVE FLANGE NUTS

Table 2-40: Drive Flange Nuts

Part Number	Description	Thread	Hex	Height
DRIVE FLANGE NUTS				
R005032	Drive Flange Nut	1/2"-20	3/4"	7/16"
R005962	Drive Flange Nut	1/2"-20	3/4"	9/16"
R005963	Drive Flange Nut	9/16"-18	7/8"	31/64"
R005961	Drive Flange Nut	9/16"-20	11/16"	13/32"
R002002	Drive Flange Nut	5/8"-18	15/16"	35/64"
R005964	Drive Flange Nut	3/4"-16	1-1/8"	5/8"

Information & Images Provided by Meritor



DRUM BOLT ASSEMBLIES

Table 2-41: Drum Bolt Assemblies

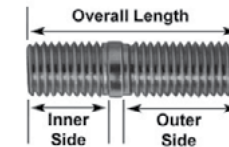
Part Number	Description	Thread Size	Length
DRUM BOLT ASSEMBLIES			
R005969	Drum Bolt Assembly	5/8"-11	2"
R005970	Drum Bolt Assembly	5/8"-18	2"
R009261	Drum Bolt Assembly	5/8"-18	2-1/4"
R005971	Drum Bolt Assembly	3/4"-10	2"
R009262	Drum Bolt Assembly	3/4"-10	2-1/4"
R005972	Drum Bolt Assembly	3/4"-16	2"



BRAKE DRUM HARDWARE

Table 2-42: Brake Drum Hardware

Part Number	Description	Thread	Length	Note
BRAKE DRUM ATTACHING SCREW				
R005018	Brake Drum Attaching Screw	1/3" -13	1"	For Outboard Mounting



RIM HARDWARE

Table 2-43: Spoke Wheel & Rim Studs- Grade 8

Part Number	Description	Overall Length	Outer Thread	Outer Length	Inner Thread	Inner Length
SPOKE WHEEL & RIM STUDS- GRADE 8						
R004955	Spoke Wheel & Rim Stud- Grade 8	2-3/8"	5/8"-11	1-7/32"	5/8"-11	7/8"
R004958	Spoke Wheel & Rim Stud- Grade 8	2-3/4"	5/8"-11	1-11/16"	5/8"-11	7/8"
R005901	Spoke Wheel & Rim Stud- Grade 8	2-7/8"	3/4"-10	1-11/16"	3/4"-10	1"

Information & Images Provided by Meritor

Part Number	Description	Overall Length	Outer Thread	Outer Length	Inner Thread	Inner Length
R004956A	Spoke Wheel & Rim Stud- Grade 8	3"	3/4"-10	1-3/4"	3/4"-10	1-1/16"
R005706	Spoke Wheel & Rim Stud- Grade 8	3-1/8"	3/4"-10	1-29/32"	3/4"-10	1"
R005726	Spoke Wheel & Rim Stud- Grade 8	3-1/4"	5/8"-11	1-7/8"	5/8"-11	7/8"
R005727	Spoke Wheel & Rim Stud- Grade 8	3-1/2"	5/8"-11	1-7/8"	5/8"-11	7/8"
R004957	Spoke Wheel & Rim Stud- Grade 8	3-9/16"	3/4"-10	1-5/8"	3/4"-10	1-5/8"
R005728	Spoke Wheel & Rim Stud- Grade 8	3-5/8"	3/4"-10	2-5/16"	3/4"-10	1"
R005729	Spoke Wheel & Rim Stud- Grade 8	4"	3/4"-10	2-11/16"	3/4"-10	1"

Information & Images Provided by Meritor

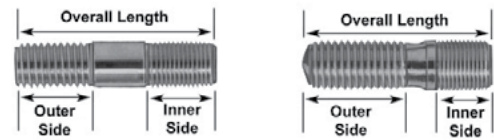


Table 2-44: Spoke Wheel & Rim Studs- Grade 8 - Special Cases

Part Number	Description	Overall Length	Outer Thread	Outer Length	Inner Thread	Inner Length
SPOKE WHEEL & RIM STUDS- GRADE 8 - SPECIAL CASES						
R005887	Spoke Wheel & Rim Stud- Grade 8 - Special Case	2-1/2"	9/16"-12	15/16"	9/16"-18	7/8"
R004987A	Spoke Wheel & Rim Stud- Grade 8 - Special Case	2-7/8"	3/4"-10	1-3/8"	3/4"-16	7/8"




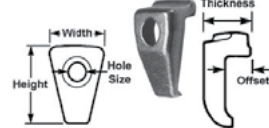
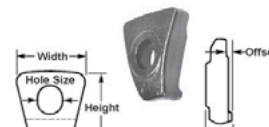


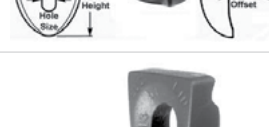



Table 2-45: Spoke Wheel & Rim Bolts



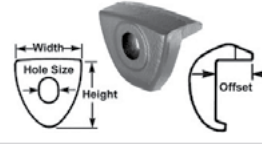


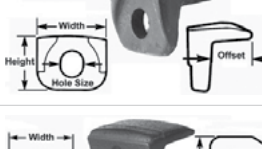



Part Number	Description	Thread	Length	Notes
SPOKE WHEEL & RIM BOLTS				
R005012	Spoke Wheel & Rim Stud- Grade 8 - Special Case	5/8"-11	2"	Use with R004986A nut. Clipped head, Round body
R004989	Spoke Wheel & Rim Stud- Grade 8 - Special Case	5/8"-11	2"	Clipped head. Use with R004986A nut.
R005712	Spoke Wheel & Rim Stud- Grade 8 - Special Case	5/8"-11	2-1/16"	Clipped head. Use with R004986A nut.
R004990	Spoke Wheel & Rim Stud- Grade 8 - Special Case	5/8"-11	2-1/8"	Use with R004962 nut.
R005761	Spoke Wheel & Rim Stud- Grade 8 - Special Case	3/4"-10	2-1/4"	Clipped head. Use with R005762 nut.

Information & Images Provided by Meritor

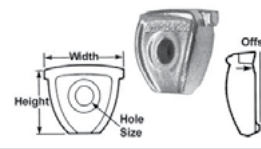


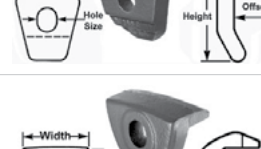


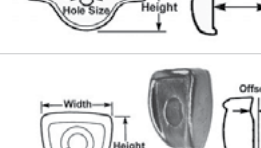
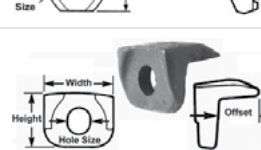
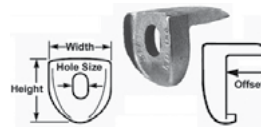

Table 2-46: Rim Clamps

Product	Part Number	Description	Height	Width	Hole Size	Offset	Comment
	R005573	Rim Clamp	2-5/16"	3-9/16"	5/8"	1-1/8"	4"
	R005927G	Rim Clamp	2"	2"	5/8"	1/2"	
	R005754	Rim Clamp	2-1/4"	2"	5/8"	5/8"	Type 1 Front Wheel
	R006054G	Rim Clamp	3-13/32"	2-1/16"	3/4"	21/32"	1-1/4"
	R006053	Rim Clamp	2-5/8"	2-1/2"	13/16"	5/16"	1"
	R005828G	Rim Clamp	2-7/16"	6"	3/4"	1-13/16"	3-3/8"
	R005782	Rim Clamp	2-3/16"	2-5/8"	3/4"	1-3/4"	3-5/8"
	R005780	Rim Clamp	1-7/8"	1-3/4"	5/8"	1/2"	
	R005902G	Rim Clamp	3-5/8"	2-1/2"	3/4"	1/2"	8"

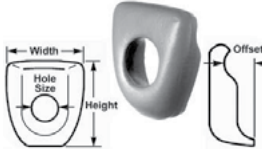

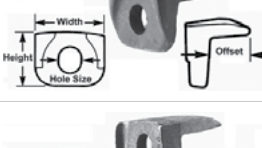
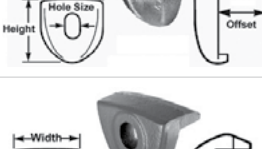






Information & Images Provided by Meritor

Product	Part Number	Description	Height	Width	Hole Size	Offset	Comment
	R005840	Rim Clamp	2-7/16"	2-13/16"	3/4"	1-1/16"	n/a
	R005890	Rim Clamp	2-1/8"	2"	3/4"	1/2"	
	R005839	Rim Clamp	2-13/32"	2-7/8"	5/8"	2"	3"
	R005033	Rim Clamp	2-7/16"	2-7/8"	5/8"	1-1/8"	
	R009024	Rim Clamp	2-3/4"	2-5/8"	3/4"	11/32"	
	R005747	Rim Clamp	1-3/4"	2-5/16"	3/4"	1-1/16"	
	R005906	Rim Clamp	2-1/4"	2-1/4"	3/4"	1-5/8"	3-5/8"
	R009023G	Rim Clamp	3-5/8"	2-1/2"	3/4"	5/8"	
	R005841	Rim Clamp	2"	1-7/8"	3/4"	17/32"	
	R005885G	Rim Clamp	2-13/32"	2-1/2"	3/4"	1-5/16"	


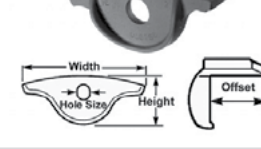
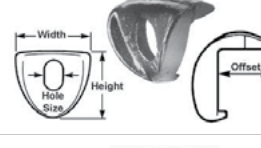
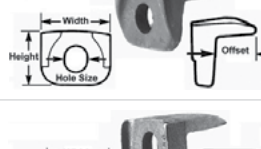
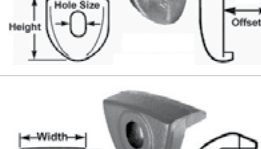
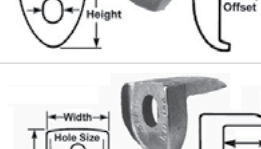

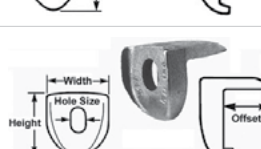
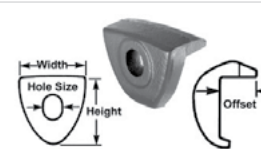
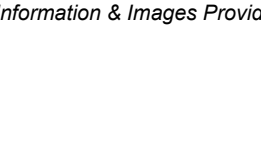

Information & Images Provided by Meritor

Product	Part Number	Description	Height	Width	Hole Size	Offset	Comment
	R005746	Rim Clamp	2-5/8"	3-1/8"	5/8"	1/4"	Offset
	R005974	Rim Clamp	2-11/32"	2-5/16"	3/4"	1-7/16"	Type 2 Rear Wheel
	R005772	Rim Clamp	2-7/16"	3"	5/8"	1-1/8"	n/a
	R005904A	Rim Clamp	2-3/8"	2-1/4"	3/4"	1-3/8"	4"
	R005785G	Rim Clamp	2-13/32"	2-7/8"	3/4"	1-7/8"	3-3/8"
	R005926G	Rim Clamp	2"	2"	3/4"	1/2"	
	R005829G	Rim Clamp	2-7/16"	6-5/8"	3/4"	1-7/16"	4"
	R005838G	Rim Clamp	2-13/16"	2-5/8"	3/4"	1/4"	
	R005753	Rim Clamp	1-3/4"	2-5/16"	3/4"	1-7/16"	
	R005882	Rim Clamp	2-7/16"	2-1/2"	3/4"	7/8"	

Information & Images Provided by Meritor

Product	Part Number	Description	Height	Width	Hole Size	Offset	Comment
	R005889	Rim Clamp	2-5/32"	2"	3/4"	17/32"	
	R005036	Rim Clamp	2-1/2"	2-1/16"	5/8"	5/8"	
	R005755	Rim Clamp	1-13/16"	2-1/4"	3/4"	1-5/16"	
	R005823	Rim Clamp	2-7/16"	2-1/2"	3/4"	1-1/8"	
	R005055	Rim Clamp	2-1/2"	2-5/8"	3/4"	1-3/4"	3-5/8"
	R005905AG	Rim Clamp	2-3/8"	2-7/8"	3/4"	1-3/16"	4"
	R005883	Rim Clamp	2-1/2"	6"	3/4"	1-5/16"	n/a
	R005047	Rim Clamp	2-1/2"	3-1/8"	5/8"	1-1/16"	4"
	R005891	Rim Clamp	2-5/32"	2"	3/4"	3/4"	
	R005822	Rim Clamp	2-7/16"	2-1/2"	3/4"	1-1/2"	

Information & Images Provided by Meritor

Product	Part Number	Description	Height	Width	Hole Size	Offset	Comment
	R005570	Rim Clamp	2-1/2"	2-13/16"	5/8"	1"	4"
	R005827G	Rim Clamp	2-1/2"	6"	31/32"	1-1/8"	n/a
	R005046	Rim Clamp	2-1/2"	3-1/8"	3/4"	1-5/32"	4"
	R005837	Rim Clamp	1-13/16"	2-1/4"	3/4"	1-13/16"	
	R005820	Rim Clamp	2-7/16"	2-1/2"	3/4"	1-5/8"	
	R005045	Rim Clamp	2-1/2"	2-13/16"	5/8"	1-3/8"	3-5/8"
	R005821G	Rim Clamp	2-7/16"	2-1/2"	3/4"	1-7/8"	
	R005044	Rim Clamp	2-1/2"	2-7/8"	5/8"	1-5/8"	3-3/8"
	R005783G	Rim Clamp	2-7/16"	2-1/2"	3/4"	2-3/8"	
	R005571AG	Rim Clamp	2-1/2"	2-7/8"	3/4"	1-1/8"	4"
	R005784G	Rim Clamp	2-1/2"	2-7/8"	3/4"	1-1/4"	4"
	R005040AG	Rim Clamp	2-1/2"	2-7/8"	3/4"	1-1/2"	3-5/8"
	R005572AG	Rim Clamp	2-1/2"	2-7/8"	3/4"	1-3/4"	3-3/8"

Information & Images Provided by Meritor

CROSS REFERENCE

CROSS REFERENCE FOR WHEELS

Table 2-47: Cross Reference for Wheels

<i>Mfr. Part Number</i>	<i>Part Number</i>
ALCOA	
883677	41644ANP
883677	41644XP
883677	41644XPC
885600	40008A1P
885600	40008ANP
885600	40008A0P

NOTES



*For information, updates, or corrections,
please contact us at TRPBus@TRPParts.com*

*No part of this marketing material may be
reproduced in any manner without written
permission from TRP® North America.*

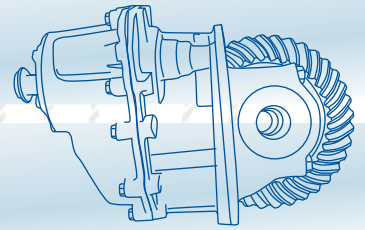
TRP® North America

750 Houser Way N.
Renton, WA 98057

www.trpparts.com



Parts for all brands of buses.



3

BUS PARTS

AXLES

*Proven, reliable and
always innovative.*

TRP® offers reliable aftermarket products that are designed and tested to exceed customers' expectations regardless of the bus make, model or age.



FRONT & REAR AXLES • DIFFERENTIALS



Tested. Reliable. Guaranteed.

Axles

Choosing the right replacement part or service for your vehicle—whether you own one, or a fleet—is one of the most important decisions you can make for your business. And, with tested TRP® parts it's an easy decision.

Regardless of the make you drive, TRP® quality replacement parts are engineered to fit your truck, trailer or bus. Choose the parts that give you the best value for your business. Check them out at an approved TRP® retailer near you.

The cross reference information in this catalog is based upon data provided by several industry sources and our partners. While every attempt is made to ensure the information presented is accurate, we bear no liability due to incorrect or incomplete information.

Product Availability

Due to export restrictions and market demands, not all products are always available in every location. Check for availability in your area with your local TRP® Distributor.

No part of this marketing material may be reproduced in any manner without written permission from TRP® North America.

CONTENTS

Axles 3-3

TRP® North America

750 Houser Way N.
Renton, WA 98057

www.trpparts.com

QUALITY AXLES YOU CAN DEPEND ON!

TRP® Bus Parts Offers a full range of parts for axle capacities from 19,000 - 23,000 lbs. rating for the following bus makes:

- Blue Bird
- Chevrolet/GMC
- Ford
- International (IC Bus)
- Thomas Built
- And many more

Features & Benefits:

- National Coverage
- Over 12,000 units in stock
- Rebuilt to OE standards

We offer carriers & other products from these quality manufacturers:

New

U.S.	Canada
Dana	Dana
Meritor	

Remanufactured

U.S.	Canada
Meritor	Meritor
Weller (for Meritor & Dana axles)	Weller (for Meritor & Dana axles) Mascot (for Meritor & Dana axles)

Some of Our Most Popular Axle Components

Dana Part Number	Meritor Part Number
J175-S	RS17140
J190-S	RS19144
J210-S	RS21141
J220-S	RS21145
J230-SB	RS23160
W230-S	RC23160



**Please contact your local dealer for specific part numbers and availability depending on axle model and ratio.*



*For information, updates, or corrections,
please contact us at TRPBus@TRPParts.com*

*No part of this marketing material may be
reproduced in any manner without written
permission from TRP® North America.*

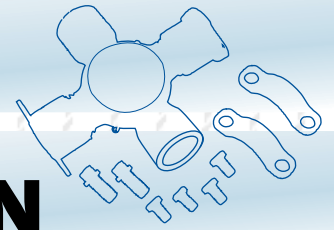
TRP® North America

750 Houser Way N.
Renton, WA 98057

www.trpparts.com



Parts for all brands of buses.



4

BUS PARTS

DRIVETRAIN

*Proven, reliable and
always innovative.*

TRP® offers reliable aftermarket products that are designed and tested to exceed customers' expectations regardless of the bus make, model or age.



U-JOINT PARTS & KITS • CENTER BEARINGS



Tested. Reliable. Guaranteed.

Drivetrain

Choosing the right replacement part or service for your vehicle—whether you own one, or a fleet—is one of the most important decisions you can make for your business. And, with tested TRP® parts it's an easy decision.

Regardless of the make you drive, TRP® quality replacement parts are engineered to fit your truck, trailer or bus. Choose the parts that give you the best value for your business. Check them out at an approved TRP® retailer near you.

The cross reference information in this catalog is based upon data provided by several industry sources and our partners. While every attempt is made to ensure the information presented is accurate, we bear no liability due to incorrect or incomplete information.

Product Availability

Due to export restrictions and market demands, not all products are always available in every location. Check for availability in your area with your local TRP® Distributor.

No part of this marketing material may be reproduced in any manner without written permission from TRP® North America.

CONTENTS

U-JOINT PARTS & KITS

Half Rounds	4-3
Full Rounds	4-4
Spicer SPL Series	4-4
U-Joint Strap & Bolt Kits	4-5
TRP® Strap & Bolt Kits	4-5
Meritor Strap & Bolt Kits	4-5

CENTER BEARINGS

Bearing Assemblies	4-6
TRP® Center Bearing Assemblies	4-6
Dana Center Bearings	4-6
Type 2 - Slotted Rubber Cushion	4-6

CROSS REFERENCE

Cross Reference for Drivetrain	4-7
--------------------------------	-----

TRP® North America

750 Houser Way N.
Renton, WA 98057

www.trpparts.com

U-JOINT PARTS & KITS

For Center Bearings See pg. 4-6.



HALF ROUNDS

- U-Joints are case hardened for long life and durability.
- All products manufactured and tested to OEM specifications for quality control.
- Center bearings contain heavy duty roller bearing for long life.
- Nationwide, 12-month warranty.



Table 4-1: U-Joint Kits - Half Rounds

Description	Series	TRP® Part Number	Dana Part Number	Meritor Part Number	Note
U-Joint Kit - Half Round 1610 Series	1610	DS674	5-674X	CP674X	TRP® with 5-70-28X type hardware kit
U-Joint Kit - Half Round 1710 Series	1710	DS675	5-675X	CP675X	TRP® 6.5-70-18X type hardware kit
U-Joint Kit - Half Round 1760 Series	1760	DS677	5-677X	CP677X	TRP® 6.5-70-18X type hardware kit
U-Joint Kit - Half Round 1810 Series	1810	DS676	5-676X	CP676X	TRP® 6.5-70-18X type hardware kit

Table 4-2: U-Joint Kits - Easy Service Half Rounds

Description	Series	TRP® Part Number	Dana Part Number	Meritor Part Number
U-Joint Kit - Half Round Easy Service 1610 Series	1610	n/a	n/a	R674X
U-Joint Kit - Half Round Easy Service 1710 Series	1710	n/a	n/a	R675X

FULL ROUNDS

Table 4-3: U-Joint Kits - Full Rounds

Description	Series	TRP® Part Number	Dana Part Number	Meritor Part Number
U-Joint Kit - Full Round 1610 Series	1610	DS279	5-279X	CP279X
U-Joint Kit - Full Round 1710 Series	1710	DS280	5-280X	CP280X
U-Joint Kit - Full Round 1760 Series	1760	DS407	5-407X	n/a
U-Joint Kit - Full Round 1810 Series	1810	DS281	5-281X	CP281X

Table 4-4: U-Joint Kits - Easy Service Full Rounds

Description	Series	TRP® Part Number	Dana Part Number	Meritor Part Number
U-Joint Kit - Full Round Easy Service 1610 Series	1610	n/a	n/a	R279X
U-Joint Kit - Full Round Easy Service 1710 Series	1710	n/a	n/a	R280X
U-Joint Kit - Full Round Easy Service 1760 Series	1760	n/a	n/a	R407X
U-Joint Kit - Full Round Easy Service 1810 Series	1810	n/a	n/a	R281X

SPICER SPL SERIES

- U-Joints are case hardened for long life and durability.
- All products manufactured and tested to OEM specifications for quality control.
- Center bearings contain heavy duty roller bearing for long life.
- Nationwide 12 month warranty.

Table 4-5: U-Joint Kits - Spicer SPL Series

Description	Series	TRP® Part Number	Dana Part Number	Meritor Part Number	Note
U-Joint Kit - SPL 170 Series	SPL 170	DS170X	SPL170-4X	US170X	TRP® Part - Permanently Lubricated U-Joint
U-Joint Kit - SPL 250 Series	SPL 250	DS250X	SPL250-4X	US250X	TRP® Part - Permanently Lubricated U-Joint

U-JOINT STRAP & BOLT KITS



Table 4-6: TRP® Strap & Bolt Kits

Part Number	Description	Series	Note
DS657018X	TRP® Strap and Bolt Kit	1710, 1810, 1760 U-Joints	Strap Kit
DS1707018X	TRP® Strap and Bolt Kit	170X	Strap Kit 170X
DS2507018X	TRP® Strap and Bolt Kit	250X	Strap Kit 250X

TRP® STRAP & BOLT KITS

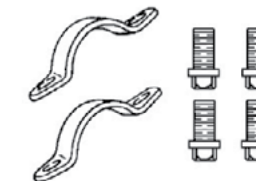
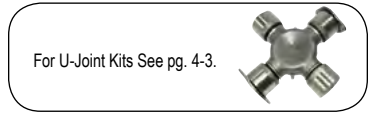


Table 4-7: Meritor Strap & Bolt Kits

Part Number	Description	Series	Note
KT17SB	Meritor Strap and Bolt Kit	1710, 1810	Contains 1 retainer strap, 4 capscrews, 4 locknuts, 4 lock washers
KT16SB	Meritor Strap and Bolt Kit	1610	Contains 1 retainer strap, 4 capscrews, 4 locknuts, 4 lock washers

MERITOR STRAP & BOLT KITS

CENTER BEARINGS



BEARING ASSEMBLIES

Table 4-8: TRP® Center Bearing Assemblies

Part Number	Description	Series
TRP® CENTER BEARING ASSEMBLIES		
DS2106611X	TRP® Center Bearing Assembly	1710, 1760, 1810, and SPL
DS2108751X	TRP® Center Bearing Assembly	1710, 1760, 1810 and SPL Solid Rubber (No Holes)
DS2106611XSA	TRP® Center Bearing Assembly - New Generation	1710, 1760, 1810, and SPL

Table 4-9: Dana Center Bearing Assemblies

Part Number	Description	Series
DANA CENTER BEARINGS		
5003326	Dana Center Bearing Assembly - New Generation	1710, 1760, 1810, and SPL
5003323	Dana Center Bearing Assembly - New Generation	1710, 1760, 1810 and SPL Solid Rubber (No Holes)

TYPE 2 - SLOTTED RUBBER CUSHION

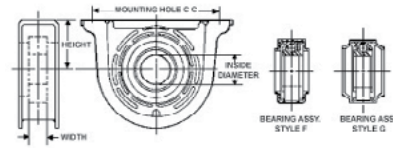


Table 4-10: Center Bearings - Type 2

Part Number	Description	Series	Bearing I.D. Max.	Bearing I.D. Min.	Height	Width	Mtg. Holes (Center to Center)	Hole Style	Note
GCB210088-1X	Center Bearing - Type 2 - slotted rubber cushion	1280, 1310, 1330, 1350, and 1410 Series	1-3/8"	1-3/8"	2-1/4"	63/64"	6-5/8"	F	n/a
CB210121-1XSA	Center Bearing - Type 2 - slotted rubber cushion	1710	1-31/32"	1-31/32"	2-13/16"	1-3/16"	7-5/8"	F	Self-aligning center bearing. Deflectors not needed. Includes two retainer straps.
CB210661-1XSA	Center Bearing - Type 2 - slotted rubber cushion	1760, 1710 (Heavy Duty), 1810	2-23/64"	2-23/64"	3-3/8"	1-13/32"	8-5/8"	F	Self-aligning center bearing. Deflectors not needed. Includes two retainer straps.

CROSS REFERENCE

CROSS REFERENCE FOR DRIVETRAIN

Table 4-11: Cross Reference for Drivetrain

Meritor Part Number	Dana Part Number	TRP® Part Number
CP103X	5-103X	SS103
CP1204X	5-1204X	n/a
CP141N	5-1206X	n/a
CP1306X	5-1306X	n/a
CP1309X	5-1309X	n/a
CP134X	5-134X	n/a
CP153X	5-153X	n/a
CP121X	5-153X	n/a
CP155X	5-155X	n/a
CP155N	5-155X	n/a
CP160X	5-160X	n/a
CP170X	5-170X	SS170
CP178X	5-178X	n/a
CP188X	5-188X	n/a
CP148N	5-213X	n/a
CP213X	5-213X	n/a
CP260X	5-260X	n/a
CP279X	5-279X	DS279
CP280X	5-280X	DS280
CP281X	5-281X	DS281
CP3147X	5-3147X	n/a
CP18N96	5-324X	n/a
n/a	5-326X	n/a
CP353X	5-353X	n/a
CP176N	5-407X	DS407
CP674X	5-674X	DS674
CP675X	5-675X	DS675
CP676X	5-676X	DS676
CP677X	5-677X	DS677

Meritor Part Number	Dana Part Number	TRP® Part Number
CPL6R-30	5-92X	n/a
US170X	SPL170-4X	DS170X
US250X	SPL250-4X	DS250X
n/a	6.5-70-18X	DS657018X
n/a	170-70-18X	DS1707018X
n/a	250-70-18X	DS2507018X
n/a	5003323	DS2106611X
n/a	5003326	DS2108751X
n/a	5003323	DS2106611XSA



*For information, updates, or corrections,
please contact us at TRPBus@TRPParts.com*

*No part of this marketing material may be
reproduced in any manner without written
permission from TRP® North America.*

TRP® North America

750 Houser Way N.
Renton, WA 98057

www.trpparts.com



Parts for all brands of buses.



5

BUS PARTS

STEERING

*Proven, reliable and
always innovative.*

TRP® offers reliable
aftermarket products
that are designed
and tested to exceed
customers' expectations
regardless of the bus
make, model or age.



GEARS • PUMPS • TIE ROD ENDS •
KING PIN KITS • STEERING SPINDLE HARDWARE



BUS PARTS

Tested. Reliable. Guaranteed.

Steering

Choosing the right replacement part or service for your vehicle—whether you own one, or a fleet—is one of the most important decisions you can make for your business. And, with tested TRP® parts it's an easy decision.

Regardless of the make you drive, TRP® quality replacement parts are engineered to fit your truck, trailer or bus. Choose the parts that give you the best value for your business. Check them out at an approved TRP® retailer near you.

The cross reference information in this catalog is based upon data provided by several industry sources and our partners. While every attempt is made to ensure the information presented is accurate, we can bear no liability due to incorrect or incomplete information.

Product Availability

Due to border issues and market demands, not all products are always available in every location. Check for availability in your area with your local TRP® Distributor.

No part of this marketing material may be reproduced in any manner without written permission from TRP® North America.

CONTENTS

STEERING GEARS

TRW Steering Gears 5-4

STEERING PUMPS

TRW Steering Pumps 5-5

STEERING ASSEMBLY PARTS

Steering Assembly Parts 5-6

DRAG LINKS

Meritor Drag Links 5-7

TIE ROD ENDS

Meritor Tie Rod Ends 5-8

TRP® KING PIN KITS

TRP® King Pin Kits 5-9

STEERING SPINDLE HARDWARE

Chevrolet Axles 5-11

Chevrolet & GMC F050, F055 Axles 5-11

Chevrolet & GMC F070 Axle 5-11

Chevrolet & GMC G30, P30, G3500 Axles 5-11

TRP® North America

750 Houser Way N.
Renton, WA 98057

www.trpparts.com

Ford Axles 5-11

Ford 5,000 lb. Front Axle 5-11

Ford 6,000 Lb. Front Axle 5-11

Mack Axles 5-12

Meritor Axles 5-13

Meritor 16,000 lb. Axle 5-13

Meritor FD-900, FD901, FE-900, FF-901, FF931 Axles 5-13

Meritor FE-970 and "E" Series Drive Axles 5-14

Meritor FG-900 Axle 5-14

Meritor FH-901, FL-901, FL-931 Axles 5-14

Navistar Axles 5-15

Navistar (Refer to Application Table for Axles) 5-15

Navistar FA48 Axle 5-15

Navistar FA68, FA72 Axles 5-15

Navistar FA70, FA89, FA91, FA98 Axles 5-15

Navistar FA71, FA73, FA101 Axles 5-15

CROSS REFERENCE

Steering Cross Reference 5-16

Blue Bird Corp 5-16

Dina 5-16

Freightliner 5-16

Gillig LLC 5-16

International/IC Bus 5-16

MCI 5-16

Spartan 5-16

Thomas Built 5-16

STEERING GEARS

For Steering Spindle Hardware See pg. 5-11.



TRW STEERING GEARS

Table 5-1: Blue Bird Steering Gears

Part Number	Description	Reman PN#	OEM PN
TAS55012	Blue Bird Before 2009 - Steering Gear	TAS55015RMAN	00123118
TAS65115A	Blue Bird Steering Gear	TAS65115RMAN	01749423
TAS65149A	Blue Bird All American (FE) - Steering Gear	TAS65149RMAN	01970441
TAS655115	Blue Bird All American (RE) - Steering Gear	TAS65115RMAN	All American (RE)

Table 5-2: Steering Gears for Other Bus Makes

Part Number	Description	Reman PN#	OEM PN
TAS65051A	IC Bus Steering Gear	TAS65051RMAN	1682483C91
TAS65175A	Thomas Built Steering Gear	TAS65175RMAN	61320623

STEERING PUMPS

For TRP® King Pin Kits See pg. 5-9.



TRW STEERING PUMPS

Table 5-3: Blue Bird Steering Pumps

Part Number	Description	Reman PN#	OEM PN
EV221616L10106	Blue Bird Power Steering Pump	n/a	00054677
EV221618L10106	Blue Bird Power Steering Pump	n/a	00125506
EV221618R10106	Blue Bird Power Steering Pump	n/a	10000051
PS221615R10301	Blue Bird Power Steering Pump	n/a	1874833
PS221616L11301	Blue Bird Power Steering Pump	n/a	0086345
PS221616L21301	Blue Bird Power Steering Pump	n/a	00086346
PS221616L324A1	Blue Bird Power Steering Pump	n/a	0101409
PS221616L334A1	Blue Bird Power Steering Pump	n/a	00097564
PS221616R10301	Blue Bird Power Steering Pump	n/a	1874825
PS221618L334A1	Blue Bird Power Steering Pump	n/a	00125508



Table 5-4: Steering Pumps for Other Bus Makes

Part Number	Description	Reman PN#	OEM PN
EV201618L10101	Thomas Built Power Steering Pump	n/a	14-14323-014

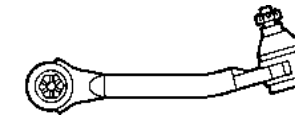
STEERING ASSEMBLY PARTS

STEERING ASSEMBLY PARTS

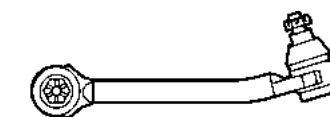
Table 5-5: Blue Bird Steering Assembly Components

Part Number	Description	Reman PN#	OEM PN
021407X1	Blue Bird Poppet Adjustment Tool	n/a	1469261
026115	Blue Bird Steering Wheel Nut	n/a	2595924
032308	Blue Bird Horn Contact Brush Assy	n/a	2593937
PBR110FAA	Blue Bird 90 Degree Miter Box	n/a	01928266
SK000282	Blue Bird Steering Intermediate Shaft U-Joint Kit	n/a	00080628
SK000283	Blue Bird Steering Intermediate Shaft U-Joint Kit	n/a	10007606
TAS550004	Blue Bird TAS55 Complete Seal Kit	n/a	00065133

DRAG LINKS



R250113



R250112

MERITOR DRAG LINKS

Table 5-6: Meritor Drag Links

Part Number	Description	Axle Rating (lbs)
R250113	Drag Link for MIDIBus - SC	6000-8000
R250113	Drag Link for Navistar Bus 3400 - 166867C91	6000-8000
R250113	Drag Link for Navistar Bus 3600 - 166867C91	6000-8000
R250112	Drag Link for Navistar Bus 3600 - 166437C91	10000+
R250113	Drag Link for Navistar Bus 3800 - 166867C91	6000-8000
R250112	Drag Link for IC Bus - 16671437C91	10000+
R250113	Drag Link for Vista (Thomas Built)	6000-8000
R250112	Drag Link for Vista (Thomas Built)	10000+
R250112	Drag Link for US. Bus - Eagle 3400	10000+

Information & Images Provided by Meritor

TIE ROD ENDS



MERITOR TIE ROD ENDS

Table 5-7: Meritor Tie Rod Ends

Part Number	Description	Application/ OEM PN	Location	Axle Rating (lbs)	Stud Center to Rod End	Axle Code Year	Notes
R230029	Tie Rod End	AmTran - 3000FE	Curbside	10000+	9.18"	02ADD	
R230028	Tie Rod End	AmTran - 3000FE	Roadside	10000+	9.18"	02ADD	
R230029	Tie Rod End	AmTran - Genesis	Curbside	10000+	9.18"	02ADD	
R230028	Tie Rod End	AmTran - Genesis	Roadside	10000+	9.18"	02ADD	
R230069	Tie Rod End	AmTran - Genesis	Curbside	12000-14000	5.44"	n/a	w/126"-225" WB.
R230068	Tie Rod End	AmTran - Genesis	Roadside	12000-14000	5.44"	n/a	w/126"-225" WB.
R230416	Tie Rod End	AmTran - Genesis	Curbside	12000-14000	9.43"	n/a	
R230415	Tie Rod End	AmTran - Genesis	Roadside	12000-14000	9.43"	n/a	
R230029	Tie Rod End	AmTran - RE	Curbside	10000+	9.18"	02ADD	
R230028	Tie Rod End	AmTran - RE	Roadside	10000+	9.18"	02ADD	
R230416	Tie Rod End	AmTran - RE	Curbside	12000-14000	9.43"	n/a	
R230415	Tie Rod End	AmTran - RE	Roadside	12000-14000	9.43"	n/a	
R230069	Tie Rod End	Blue Bird - All American	Curbside	6000-8000	5.44"	02ADC	w/126"-225" WB.
R230068	Tie Rod End	Blue Bird - All American	Roadside	6000-8000	5.44"	02ADC	w/126"-225" WB.
R230069	Tie Rod End	Meritor - FF-931, FF-932, FF-933, FF-934, FF-941, FF-942, FF-943, FF-944, FF-967, FG-941, FG-943	Curbside	12000-13000	5.44"	n/a	Greaseable type.
R230068	Tie Rod End	Meritor - FF-931, FF-932, FF-933, FF-934, FF-941, FF-942, FF-943, FF-944, FF-967, FG-941, FG-944	Roadside	12000-13000	5.44"	n/a	Greaseable type.
R230090	Tie Rod End	Meritor - FF-931, FF-932, FF-933, FF-934, FF-941, FF-942, FF-943, FF-944, FF-967, FG-941, FG-945	Roadside	12000-13000	5.44"	n/a	Greaseable type. Optional 1.125"-18 thread.
R230069	Tie Rod End	Navistar - 3800, OEM 507838C91	Curbside	6000-8000	5.44"	02ADC	w/126"-225" WB.
R230068	Tie Rod End	Navistar - 3800, OEM 507837C91	Roadside	6000-8000	5.44"	02ADC	w/126"-225" WB.
R230029	Tie Rod End	Navistar - 3800	Curbside	10000+	9.18"	02ADD	
R230028	Tie Rod End	Navistar - 3800	Roadside	10000+	9.18"	02ADD	
R230069	Tie Rod End	IC OEM 507838C91	Curbside	6000-8000	5.44"	02ADC	w/126"-225" WB.
R230068	Tie Rod End	IC OEM 507837C91	Roadside	6000-8000	5.44"	02ADC	w/126"-225" WB.
R230029	Tie Rod End	IC Bus	Curbside	10000+	9.18"	02ADD	
R230028	Tie Rod End	IC Bus	Roadside	10000+	9.18"	02ADD	
R230069	Tie Rod End	Thomas Built - SAF-T-Liner & MVP	Curbside	6000-8000	5.44"	02ADC	w/126"-225" WB.
R230068	Tie Rod End	Thomas Built - SAF-T-Liner & MVP	Roadside	6000-8000	5.44"	02ADC	w/126"-225" WB.
R230069	Tie Rod End	Vista	Curbside	6000-8000	5.44"	02ADC	w/126"-225" WB.
R230068	Tie Rod End	Vista	Roadside	6000-8000	5.44"	02ADC	w/126"-225" WB.
R230029	Tie Rod End	Vista	Curbside	10000+	9.18"	02ADD	
R230028	Tie Rod End	Vista	Roadside	10000+	9.18"	02ADD	

Information & Images Provided by Meritor

TRP® KING PIN KITS



Product Design:

- Meet or exceeds OEM designs.
- Manufactured using state-of-the-art heat treatment and machine tool technology.
- 100% manufacturing lot traceable.
- Manufactured with steel from OEM approved mills.

Product Features:

- Manufactured to meet or exceed OEM specifications.
- Backed by a two year/250,000 mile warranty - best in the industry.
- Provide the most comprehensive industry all makes coverage with 360 applications in 2,600 configurations.
- Offer cradle to grave replacement kit coverage.

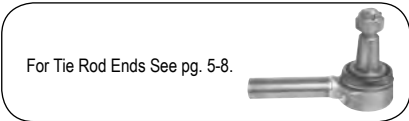
TRP® KING PIN KITS

Table 5-8: TRP® King Pin Kits for International

Part Number	Description	Axle Model	Axle Code Year	Axle Rating Lbs.	Bushing Type	King Pin Size	Type of King Pin	Notes
SK605	TRP® King Pin Kit - International 591945C92	FA109	02109	9,000	Bronze	1.484" x 8.85"	B	
SK546	TRP® King Pin Kit - International 473695C92	FA71	02071	5,000	Bronze	1.359" x 7.97"	A	
SK644	TRP® King Pin Kit - International 1658934C93	FA309 FA339	02309 02339	9,000 12,000	Composite	1.609" x 9.16"	B	
SK659	TRP® King Pin Kit - International 493095C94	FA309	02309	9,000	Composite	1.611" x 9.16"	A	
SK644	TRP® King Pin Kit	FA329 FA139	02329 02139	10,500 12,000	Composite	1.609" x 9.16"	B	
SK577	TRP® King Pin Kit - International 134456R91	FA68 FA70	02068 02072	5,000 5,500	Bronze	1.234" x 6.75"	A	
SK550	TRP® King Pin Kit - International 493095C93	FA309	02309	9,000	Bronze	1.609" x 9.16"	A	
SK525	TRP® King Pin Kit - 12K Meritor Axle - International 452344C91	FA228	02228	12,000	Bronze	1.7935" x 10.41"	B	Rockwell axle FF921
SK507	TRP® King Pin Kit - International 303139C92	FA215 FA218	02215 02218	12,000	Bronze	1.7935" x 9.12"	B	

Part Number	Description	Axle Model	Axle Code/Year	Axle Rating Lbs.	Bushing Type	King Pin Size	Type of King Pin	Notes
SK464	TRP® King Pin Kit	FA215 FA218	02215 02218	12,000	Nylon	1.7935" x 9.12"	B	
SK549	TRP® King Pin Kit - International 493094C94	FA139	02139	12,000	Bronze	1.609" x 9.66"	A	
SK513	TRP® King Pin Kit - International 303140C92	FA136	02136	16,000	Nylon	1.99" x 11.04"	B	Rockwell axle FH901
SK512	TRP® King Pin Kit	FA136	02136	16,000	Nylon	1.99" x 11.04"	B	Rockwell axle FH901
SK496	TRP® King Pin Kit	FA105 FA208	02105 02208	9,000	Nylon	1.4335" x 8.5"	B	Rockwell axle FD900
SK510	TRP® King Pin Kit - International 303136C92	FA105	02105	9,000	Bronze	1.4335" x 8.5"	B	Rockwell axle FD900
SK774	TRP® King Pin Kit - International 1660271C92	FA101/I-75	02101	7,500	Bronze	1.359" x 7.79"	B	
SK645	TRP® King Pin Kit	FA101/I-75	02101	7,500	Composite	1.359" x 7.79"	B	
SK546	TRP® King Pin Kit - International 473695C92	FA101/I-75	02101	7,500	Bronze	1.359" x 7.97"	A	
SK554	TRP® King Pin Kit - International 134457R91	FA89 FA91 FA91/ FA98	02089 02091 02091/ 02098	5,500 7,000 7,500	Bronze	1.234" x 7.66"	A	
SK554	TRP® King Pin Kit - International 61556R91	FA89 FA91 FA91/ FA98	02089 02091 02091/ 02098	5,500 7,000 7,500	Bronze	1.234" x 7.66"	A	
SK546	TRP® King Pin Kit - 6K Dana Axle - International 473695C92	FA73	02073	6,000	Bronze	1.359" x 7.97"	A	
SK772	TRP® King Pin Kit - International 1658934C93	FA71 FA73 FA101/I-75	02071 02073 02101	9,000 10,500 12,000	Bronze	1.609" x 9.16"	B	
SK662	TRP® King Pin Kit - International 1648204C92	FA71 FA73 FA101/I-75	02071 02073 02101	5,000 6,000 7,500	Composite	1.361" x 7.79"	A	.015 Oversize.
SK658	TRP® King Pin Kit - International 493094C95	FA329 FA139/ FA339	02329 02139/ 02339	10,500 12,000	Composite	1.611" x 9.66"	A	
SK657	TRP® King Pin Kit	FA71 FA73 FA101/I-75	02071 02073 02101	5,000 6,000 7,500	Composite	1.359" x 7.97"	A	
SK577	TRP® King Pin Kit - International 70594R91	FA68 FA70	02068 02072	5,000 5,500	Bronze	1.234" x 6.75"	A	
SK578	TRP® King Pin Kit - International 69971R91	FA48	02048	4,700	Bronze	1.1095" x 6.25"	A	

STEERING SPINDLE HARDWARE



R004874/ R004879



R004849



R004854/ R004865

CHEVROLET AXLES

Table 5-9: Steering Spindle Hardware for Chevrolet & GMC Axles

Part Number	Description	Across Flats	Thread Size	Thickness	Washer Outside Diameter	Washer Inside Diameter
CHEVROLET & GMC F050, F055 AXLES						
R004874	Washer			9/64"	2-1/2"	7/8"
R004849	Spindle Nut	1-1/4"	7/8"-20	13/16"		

CHEVROLET & GMC F070 AXLE

R004854	Spindle Nut	1-5/8"	1-1/8"-16	3/4"		
---------	-------------	--------	-----------	------	--	--

CHEVROLET & GMC G30, P30, G3500 AXLES

R004879	Washer			1/8"	2-1/4"	7/8"
R004865	Spindle Nut	1-1/4"	27/32"-20	9/16"		

FORD AXLES

Table 5-10: Steering Spindle Hardware for Ford Axles

Part Number	Description	Across Flats	Thread Size	Thickness	Washer Outside Diameter	Washer Inside Diameter
FORD 5,000 LB. FRONT AXLE						
R004867	Washer			5/32"	2-3/4"	1"
R004859	Spindle Nut	1-7/16"	1"-14	5/8"		

FORD 6,000 LB. FRONT AXLE

R004869	Washer			3/16"	3"	1-1/2"
R004861	Spindle Nut	2-1/4"	1-1/2"-18	7/8"		



R003501



R003502

MACK AXLES

Table 5-11: Steering Spindle Hardware for Mack Front Axles

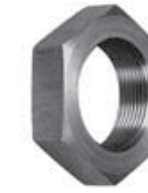
Part Number	Description	Across Flats	Thread Size	Thickness	Washer Outside Diameter	Washer Inside Diameter
R003502	Washer			1/8"	3"	
R003501	Spindle Nut	2-5/8"	1-5/8"-12	3/8"		



R002659



R002660



R002658



1227S1527



R002297



R002296



R002299



R002298



R003510



R002663

MERITOR AXLES

Table 5-12: Steering Spindle Hardware for Meritor Axles

Part Number	Description	Across Flats	Thread Size	Thickness	Washer Outside Diameter	Washer Inside Diameter
MERITOR 16,000 LB. AXLE						
R002659	Flat Washer (Service with KIT 1416)			1/32"	3-1/4"	1-25/32"
R002660	Lock Ring (Service with KIT 1416)			7/32"	3"	1-25/32"
R002658	Nut (Service with KIT 1416)	2-1/2"	1-3/4"-12	11/16"		
1227S1527	Inner Nut (Service with KIT 1416)	3-7/8"	1-3/4"-12	1/2"		
MERITOR FD-900, FD901, FE-900, FF-901, FF931 AXLES						
R002298	Washer			3/64"	3"	1-33/64"

Information & Images Provided by Meritor

Part Number	Description	Across Flats	Thread Size	Thickness	Washer Outside Diameter	Washer Inside Diameter
R002297	Lock Washer			3/16"	2-3/4"	1-17/32"
R002296	Outer Nut	2-1/4"	1-1/2"-12	7/16"		
R002299	Inner Nut	2-5/8"	1-1/2"-12	3/8"		

MERITOR FE-970 AND "E" SERIES DRIVE AXLES

R002301	Lock Ring			1/16"	3-5/16"	2-1/4"
R002302	Flat Washer			1/4"	4-5/16"	2-1/4"
R002300	Nut	2-7/8"	2-1/4"-16	5/16"		

MERITOR FG-900 AXLE

R002659	Flat Washer (Service with KIT 1416)			1/32"	3-1/4"	1-25/32"
R002660	Lock Ring (Service with KIT 1416)			7/32"	3"	1-25/32"
R003510	Inner Nut (Service with KIT 1416)	1-3/4"-12	1/2"	3-5/16"		
R002658	Nut (Service with KIT 1416)	2-1/2"	1-3/4"-12	11/16"		

MERITOR FH-901, FL-901, FL-931 AXLES

R002659	Flat Washer (Service with KIT 1416)			1/32"	3-1/4"	1-25/32"
R002660	Lock Ring (Service with KIT 1416)			7/32"	3"	1-25/32"
R002663	Flat Washer			1/4"	4-1/8"	1-25/32"
R002658	Nut (Service with KIT 1416)	2-1/2"	1-3/4"-12	11/16"		
1227S1527	Inner Nut (Service with KIT 1416)	3-7/8"	1-3/4"-12	1/2"		

Information & Images Provided by Meritor



R004871



R003502



R003501



R004854



R004874



R004870

NAVISTAR AXLES

Table 5-13: Steering Spindle Hardware for Navistar Axles

Part Number	Description	Across Flats	Thread Size	Thickness	Washer Outside Diameter	Washer Inside Diameter
NAVISTAR (REFER TO APPLICATION TABLE FOR AXLES)						
R004871	Lock Washer			3/32"	3-7/16"	2-3/32"
R006139	Washer (larger Outside Diameter)			1/4"	4-1/8"	2-3/32"
R006138	Washer (smaller Outside Diameter)			1/4"	3-3/4"	2-3/32"
R004855	Inner-Outer Nut	2-7/8"	2-1/16"-16	3/8"		

NAVISTAR FA48 AXLE

R004875	Washer			13/64"	2-1/8"	1"
R004850	Spindle Nut	1-1/4"	7/8"-14	3/4"		

NAVISTAR FA68, FA72 AXLES

R004851	Spindle Nut	1-1/2"	1"-14	7/8"		
---------	-------------	--------	-------	------	--	--

NAVISTAR FA70, FA89, FA91, FA98 AXLES

R004868	Washer			5/32"	2-5/8"	1-1/8"
R004853	Spindle Nut	1-5/8"	1-1/8"-12	3/4"		

NAVISTAR FA71, FA73, FA101 AXLES

R004870	Washer			3/4"	2-1/32"	1-1/8"
R004852	Spindle Nut	1-5/8"	1-1/8"-12	1/2"		



*For information, updates, or corrections,
please contact us at TRPBus@TRPParts.com*

*No part of this marketing material may be
reproduced in any manner without written
permission from TRP® North America.*

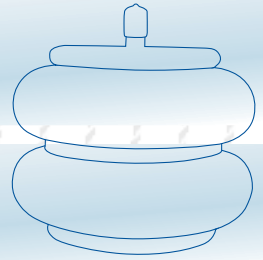
TRP® North America

750 Houser Way N.
Renton, WA 98057

www.trpparts.com



Parts for all brands of buses.



6

BUS PARTS[®]

SUSPENSION

*Proven, reliable and
always innovative.*

TRP[®] offers reliable aftermarket products that are designed and tested to exceed customers' expectations regardless of the bus make, model or age.



AIR SPRINGS • HEIGHT CONTROL VALVES •
SHOCK ABSORBERS • SUSPENSION COMPONENTS



BUS PARTS

Tested. Reliable. Guaranteed.

Suspension

Choosing the right replacement part or service for your vehicle—whether you own one, or a fleet—is one of the most important decisions you can make for your business. And, with tested TRP® parts it's an easy decision.

Regardless of the make you drive, TRP® quality replacement parts are engineered to fit your truck, trailer or bus. Choose the parts that give you the best value for your business. Check them out at an approved TRP® retailer near you.

The cross reference information in this catalog is based upon data provided by several industry sources and our partners. While every attempt is made to ensure the information presented is accurate, we can bear no liability due to incorrect or incomplete information.

Product Availability

Due to border issues and market demands, not all products are always available in every location. Check for availability in your area with your local TRP® Distributor.

No part of this marketing material may be reproduced in any manner without written permission from TRP® North America.

CONTENTS

AIR SPRINGS

Air Springs	6-5
Air Springs Cross Reference	6-11
Bellows	6-11
Firestone	6-11
Good Year	6-11

HEIGHT CONTROL VALVES

Height Control Valves	6-12
TRP® Height Control Valves	6-12
Hadley Height Control Valves	6-12
Barksdale Height Control Valves	6-12

SHOCK ABSORBERS

ABC Bus	6-13
Blue Bird	6-13
All American Bus	6-13
Blue Bird Buses with Neway Suspension	6-14
Blue Bird Buses with Reyco Suspension	6-14
Blue Bird City Bird Bus Models	6-14
Blue Bird Motor Home	6-14
Blue Bird Rear Engine Models	6-15

TRP® North America

750 Houser Way N.
Renton, WA 98057

www.trpparts.com

TC 2000 Bus	6-15	DuraStar - 4300, 4400 Series	6-34
Vision Bus	6-15	S Series School Bus	6-34
Blue Bird Wanderlodge	6-16	Series 3000 - School Bus Chassis	6-37
Other Blue Bird Models	6-16	M.A.N. Bus	6-38
Bus & Truck Co.	6-17	MAECO	6-39
Carpenter	6-17	Matson School Bus	6-39
Chevrolet Truck	6-17	MCI (Motor Coach Industries)	6-39
4, 40, 4000 & 4500 Series	6-17	NEOPLAN Bus	6-40
5, 50, 5000 & 5500 Series	6-17	NOVA Bus	6-40
6, 60, 6000 & 6500 Series	6-18	Optima Bus Corporation	6-42
7, 70 & 7000 Series	6-21	Orion Bus Industries	6-42
8, 80 & 8000 Series	6-21	Prevost	6-44
B - Series	6-21	Ridewell Corporation	6-45
Continental Trailways - Eagle International	6-22	SAF Holland	6-45
Dina Bus	6-22	Thomas Built	6-49
Dodge Truck	6-22	TMC (Transportation Manufacturing Corporation)	6-50
Eagle Motor Coach	6-23	Van Hool	6-51
City Bus	6-23		
CNG Bus	6-24		
Fixible Model 870	6-24		
Other Fixible Models	6-24		
Ford	6-26		
Freightliner Custom Chassis	6-27		
School Buses	6-27		
Shuttle Buses	6-27		
Gillig LLC	6-28		
School Buses	6-28		
Transit Buses	6-28		
GMC Truck	6-28		
5000 Series	6-28		
6000 Series	6-28		
6500 Series	6-30		
7500 Series	6-31		
B - Series	6-32		
Greyhound Bus	6-32		
Grumman Bus	6-33		
Highway Product	6-33		
BE200 School Bus - Small Bus Chassis	6-33		
		SP-217 B AIRTEK® for International IC Bus Vehicles	6-52
		SP-172C SOFTEK® - Blue Bird All American Buses - 13.2K/14.6K Capacity, LH Drive Steertek Axle	6-56
		SP-172C AIRTEK® - Blue Bird All American Buses 13.2K/14.6K Capacity, RH Drive Steertek Axle	6-60
		SP-172 C AIRTEK® - Blue Bird All American Buses – 14.6K Capacity, LH Drive Steertek Axle	6-62
		SP-172 C SOFTEK® - Blue Bird Vision Buses – 8K/10K Capacity	6-66
		SP-172 C AIRTEK® - Blue Bird Vision Buses – 10K Capacity	6-70
		SP-173 C Comfort Air	6-74

HENDRICKSON SUSPENSIONS

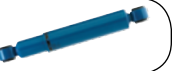
NEWAY SUSPENSIONS

AS Series 6-78
 ASB Series 6-80
 AS Service Rebuild Kits (SRKs) 6-82
 AS Front Pivot Connection, SRK-502 (PN: 481 00 366) 6-82
 ASB Service Rebuild Kits (SRKs) 6-83
 ASB Track Bar Kit, SRK-617 (PN: 481 00 483) 6-83
 ASB Sway Bar Kit, SRK-616 (PN: 481 00 480) 6-83

AIR SPRINGS



For Shock Absorbers See pg. 6-13.



AIR SPRINGS

Table 6-1: TRP® Bus Air Springs

Product	OEM Part Number	Application	Bellows Number
	AS54090	Air Spring for AM General 5973923, 5973877 / New Flyer 5973877, 5993113	6 6.5-13
	AS90390	Air Spring for Blue Bird 300-0961250 / Flxible 6-336-202 / MCI/TMC (City Cruiser) 12TA-1-2 / Orion 101324014	9 10-10
	AS89970	Air Spring for Blue Bird 800 961425, 1263581 / El Dorado 71040301 / Flxible 6 336 196	6 6.5B-11
	AS91050	Air Spring for Blue Bird 90557038 / Chance 270-03377 / Flxible 6 336 205 / Neoplan Low Floor MD-1063009	9 10-12

See Bus Application Cross Reference immediately following this section.

Product	OEM Part Number	Application	Bellows Number
	AS69100	Air Spring for Diesel Nacional AX-8127-19	FD 200-19
	AS54060	Air Spring for Flxible 6 336-11 / GMC 715611	6 6.5-13
	AS53100	Air Spring for Flxible 6 336-2 / Crown Coach 6 336-2	6 6.5-11
	AS53000	Air Spring for Flxible 6 336-4	6 6.5-11
	AS53110	Air Spring for Flxible 6 379-1	6 6.5-11

See Bus Application Cross Reference immediately following this section.

Product	OEM Part Number	Application	Bellows Number
	AS53150	Air Spring for Flxible 6 379-6	6 6.5-11
	AS69050	Air Spring for Flxible 6-336-12	FD 200-19
	AS91210	Air Spring for Flxible 6-336-182 / MCI/TMC 12M 4 6 / MCI/TMC Service # 12F 4 34	11 10.5-17
	AS99610	Air Spring for Flxible 97-2410-3, 972410-5	11 10.5-17
	AS80530	Air Spring for Gillig LLC 53-20415	11 10.5C-16

See Bus Application Cross Reference immediately following this section.

Product	OEM Part Number	Application	Bellows Number
	AS93250	Air Spring for Gillig LLC 87-17289	9 10-12
	AS52980	Air Spring for Gillig LLC Low Floor Front 08 372 09 000N	6 6.5B-11
	AS71170	Air Spring for GMC Bellows Only 686145, 2292367 / MCI 12C-1-35	FS 530-14
	AS94390	Air Spring for Hagie Manufacturing or Waggoner's Truck	9 9-14
	AS94400	Air Spring for Mansen	9 9-12

See Bus Application Cross Reference immediately following this section.

Product	OEM Part Number	Application	Bellows Number
	AS90600	Air Spring for New Flyer 000065, 014635 (Composite)	9 10-14
	AS91270	Air Spring for New Flyer 009594	9 10-14
	AS94650	Air Spring for New Flyer 009865	9 9-14
	AS93850	Air Spring for New Flyer 055089	9 9-14
	AS53160	Air Spring for New Flyer 6160104	6 6.5-11

See Bus Application Cross Reference immediately following this section.

Product	OEM Part Number	Application	Bellows Number
	AS92230	Air Spring for Reyco 12884-01, 12884-01A	9 10-16
	AS89000	Air Spring for Reyco 17361-01	9 9-12
	AS71800	Air Spring for Ridewell 1003587180C	FD 330-22
	AS69000	Air Spring for Trailer De Monterrey 73312 / Diesel Nacional A1Z-8127-19	FD 200-19

See Bus Application Cross Reference immediately following this section.

CROSS REFERENCE

AIR SPRINGS CROSS REFERENCE

Table 6-2: Air Springs Cross Reference

Mfg. Part Number	TRP® Part Number
------------------	------------------

BELLOWS

6 6.5-11	AS53000
6 6.5-11	AS53100
6 6.5-11	AS53110
6 6.5-11	AS53150
6 6.5-11	AS53160
6 6.5-13	AS54060
6 6.5-13	AS54090
6 6.5B-11	AS52980
6 6.5B-11	AS89970
9 10-10	AS90390
9 10-12	AS89370
9 10-12	AS91050
9 10-12	AS93250
9 10-14	AS99590
9 10-14	AS90600
9 10-14	AS91270
9 10-16	AS92230
9 9-12	AS89000
9 9-12	AS94400
9 9-14	AS93850
9 9-14	AS94390
9 9-14	AS94650
10 100-14	AS86160
10 10U-13	AS87390
11 10.5-15	AS92360

Mfg. Part Number	TRP® Part Number
11 10.5-17	AS91210
11 10.5-17	AS99610
11 10.5C-16	AS80530
FD 200-19	AS69000
FD 200-19	AS69050
FD 200-19	AS69100
FD 330-22	AS71800
FS 530-14	AS71170

FIRESTONE

W013509325	AS93250
W013585298	AS52980
W013585300	AS53000
W013585310	AS53100
W013585311	AS53110
W013585315	AS53150
W013585316	AS53160
W013585406	AS54060
W013585409	AS54090
W013587180	AS71800
W013588053	AS80530
W013588616	AS86160
W013588900	AS89000
W013588997	AS89970
W013589039	AS90390
W013589105	AS91050
W013589223	AS92230
W013589439	AS94390
W013589440	AS94400
W013589959	AS99590
W013676900	AS69000
W013676905	AS69050
W013676910	AS69100
W013679961	AS99610
W016537117	AS71170
W016539121	AS91210
W01W358739	AS87390

Mfg. Part Number	TRP® Part Number
W01W358937	AS89370
W01W359060	AS90600
W01W359127	AS91270
W01W359236	AS92360
W01W359385	AS93850
W01W359465	AS94650

GOOD YEAR

1R11-039	AS94390
1R11-204	AS89000
1R12-095	AS90390
1R12-132	AS91050
1R12-188	AS92230
1R12-505	AS93250
1R12-512	AS91270
1R13-039	AS91210
1R14-115	AS99610
1R14-147	AS80530
1R8-009	AS53100
1R9-003	AS54060
1R9-003	AS54090
1R9-038	AS54060
1R9-041	AS53100
1R9-065	AS89970
2B12-425	AS71800
2B9-200	AS69100
2B9-206	AS69050

HEIGHT CONTROL VALVES

HEIGHT CONTROL VALVES

Table 6-3: Height Control Valve

OEM Part Number	Description
-----------------	-------------

TRP® HEIGHT CONTROL VALVES



HCV-UN007	Height Control Valve Assembly, universal leveling valve kit
-----------	---

HADLEY HEIGHT CONTROL VALVES



H01500UN	Universal Leveling Valve Kit, Chassis NGHCV, Non Dump - Kit Includes multiple lever lengths to allow for replacement of all leveling valves.
H01501UD	Universal Leveling Valve Kit, Chassis NGHCV, Pressure Dump, 3/8" PTC air connections, 1/4" PTC Dump - Kit Includes multiple lever lengths to allow for replacement of all leveling valves.
H01501PUD	Universal Leveling Valve Kit, Chassis NGHCV, Pressure Dump, 1/4" PTC air connections - Kit Includes multiple lever lengths to allow for replacement of all leveling valves.

BARSDALE HEIGHT CONTROL VALVES



KD2454	Chassis Air Ride applications, Integral Dump Feature, 1/4" NPT Ports, Compression Fittings included, Bolt-in installation, No drilling required.
--------	--

SHOCK ABSORBERS

TRP® Bus Parts offers three levels of shock absorbers for buses that will meet the needs of all customers, from the budget conscious to the most discerning.

Fleetline™

For those customers who need a shock with a long lifespan and a quality ride but are concerned most about the bottom line, Fleetline™ shocks are an ideal choice. Fleetline™ shocks are hydraulic and carry a one-year warranty.

TRP® GS

For customers that operate on harsher roads, such as washboard or in more rural areas, TRP® Bus Parts recommends the TRP® GS gas shock. The TRP® GS shock has a unique gas cell bladder which prevents the loss of gas through the rod seal and does not allow the

gas to mix with the hydraulic oil, which can create loss of performance in shocks. The TRP® GS shock is easy to adjust by rotating the shock body. Customers can control ride performance with regular, firm and extra-firm settings. TRP® GS shocks come with an industry-leading two-year warranty.

PACCAR® OE Plus

Customers that either operate in the most extreme conditions or desire the longest-lasting shock available should choose the OE Plus shock absorber. PACCAR® OE Plus shocks are designed to exceed the performance and shock life of OEM-provided shocks. PACCAR® OE Plus shocks have been built with a bulged body for increased fluid capacity and heat dissipation and are engineered with premium components, providing a durable shock that resists chemical corrosion and wear even in the most severe applications. PACCAR® OE Plus shocks are backed by a three-year warranty.

ABC Bus



Table 6-4: ABC Bus Shocks

OEM Part Number	Description	PACCAR OE Plus	Position	TRP® Gas	Position	Fleetline	Position
12J-5-10	Drive Axle - Models with OEM Number					85733	Rear
050134513	Models with OEM Number					85732	Front
12L-5-88	Models with OEM Number					85729	Rear
6243-13790	Models with OEM Number					85708	Front or Rear
6243-14040	Models with OEM Number					85708	Front or Rear
680323	Additional OEM Interchanges					85700	1
3166657	Additional OEM Interchanges					85700	1
12B-5-1	Additional OEM Interchanges					85700	1
15L-5-114	Additional OEM Interchanges					85727	1

BLUE BIRD

Table 6-5: Blue Bird Shocks

OEM Part Number	Description	PACCAR OE Plus	Position	TRP® Gas	Position	Fleetline	Position
0015222	All American Models with Hendrickson Parasteer Suspensions					85919	Front

Legend:

- 1: Shock suits Front or Rear application as seen on vehicle
- 2: Further shock information unavailable at the time of print

PACCAR Parts recommends Fleetline™ shocks for budget conscious customers. For customers operating on washboard roads or who want maximum ride-control, an upgrade to TRP® GS shocks is recommended. Customers who want the highest-quality ride and the longest-lasting shock absorber should order the PACCAR® OE Plus shock.

OEM Part Number	Description	PACCAR OE Plus	Position	TRP® Gas	Position	Fleetline	Position
0040015	All American Models with Hendrickson Para-steer Suspensions					85919	Front
0085991	All American Models with Comfort Air Suspensions					85337	Rear
0823054	All American					85304	Front
481700131438	All American Models with Hendrickson Para-steer Suspensions					85919	Front
58913-011	All American Buses (FE & RE Models) With Hendrickson 14,600 lb Capacity-Left Hand Drive Steertek Axle					85959	Front
59483-000	All American Models with Hendrickson Para-steer Suspensions					85919	Front
60665-005	All American Models with Hendrickson Para-steer Suspensions					85919	Front
60998-001	All American Models with Comfort Air Suspensions					85337	Rear
60998-002	All American Models with Hendrickson Para-steer Suspensions					85919	Front
AMS65109	All American Buses (FE & RE Models) With 13,200 lb, 2-Leaf Parabolic Springs			89432	Front		
AMS65110	All American Buses (FE & RE Models) With 19,000 lb - 21,000 lb - 2 Stage Leaf Springs			89430	Rear	85005	Rear

BLUE BIRD BUSES WITH NEWAY SUSPENSION

1526417	Buses with Neway Air Suspension					85052	Rear
90044448	Buses with Neway Air Suspension					85051	Rear
90045083	Buses with Neway Air Suspension with shock stamping					85910	Rear
90044915	Buses with Neway Air Suspensions with OEM Number					83127	Rear

BLUE BIRD BUSES WITH REYCO SUSPENSION

1668722	Buses with Reyco Air Suspension			89440	1	85030	1
1668730	Buses with Reyco Air Suspension	665632	Rear	89414	Rear	85013	Rear
1722222	Buses with Reyco Air Suspension	665632	Rear	89414	Rear	85013	Rear

BLUE BIRD CITY BIRD BUS MODELS

609180	City Bird Buses with 1" Mounting Pins					85304	Rear
614958	City Bird Buses with 1" Mounting Pins					85307	Front
300-0614966	City Bird Buses with 1" Mounting Pins					85307	Front or Rear
300-0614974	City Bird Buses with 1" Mounting Pins					85304	Rear

BLUE BIRD MOTOR HOME

7805-N-1002	Motor Home with IFS (37 Foot)					85329	Front
-------------	-------------------------------	--	--	--	--	-------	-------

Legend:

- 1: Shock suits Front or Rear application as seen on vehicle
2: Further shock information unavailable at the time of print

PACCAR Parts recommends Fleetline™ shocks for budget conscious customers. For customers operating on washboard roads or who want maximum ride-control, an upgrade to TRP® GS shocks is recommended. Customers who want the highest-quality ride and the longest-lasting shock absorber should order the PACCAR® OE Plus shock.

OEM Part Number	Description	PACCAR OE Plus	Position	TRP® Gas	Position	Fleetline	Position
7805-S-1007	Motor Home with IFS (37 Foot)					85329	Front

BLUE BIRD REAR ENGINE MODELS

609180	Rear Engine Model School Buses with 1" Mounting Pins					85304	Rear
614958	Rear Engine Model School Buses with 1" Mounting Pins					85307	Front
300-0614966	Rear Engine Model School Buses with 1" Mounting Pins					85307	Front or Rear
300-0614974	Rear Engine Model School Buses with 1" Mounting Pins					85304	Rear

TC 2000 Bus

1004167	TC 2000 Bus, TC/2000 FE Series With Ridewell Front Suspension Option #4540					85712	Front
1316546	TC 2000 Bus, TC/2000 FE Series With Ridewell Front Suspension Option #4540					85006	Rear
1658533	TC 2000 Bus, TC/2000 FE Series With Ridewell Front Suspension Option #4540					85010	Rear
1667831	TC 2000 Bus, TC/2000 FE Series With Ridewell Front Suspension Option #4540					85029	Front
1746163	TC 2000 Bus, TC/2000 FE Series With Standard Flat Leaf Rear Springs					85006	Rear
90045050	TC 2000 Bus, TC/2000 FE Series With Neway Rear Air Suspension					85914	Front or Rear
300-1317767	TC 2000 Bus, TC/2000 FE Series With Ridewell Front Suspension Option #4540					85029	Front
305-0961284	TC 2000 Bus, TC/2000 FE Series With Ridewell Rear Suspension Option #4540					85734	Rear

VISION BUS

0055008	Vision Models with Hendrickson Softek Suspension with Steertek Axle					85959	Front
0055017	Vision Models with Hendrickson Airtek Front Air Suspension					85959	Front
0085990	Vision Models with Hendrickson Airtek Front Air Suspension					85959	Front
0085991	Vision Models with Comfort Air Suspensions					85337	Rear
58913-007	Vision Models with Hendrickson Airtek Front Air Suspension					85959	Front
58913-007	Vision Models with Hendrickson Softek Suspension with Steertek Axle					85959	Front
58913-008	Vision Models with Hendrickson Airtek Front Air Suspension					85959	Front

Legend:

- 1: Shock suits Front or Rear application as seen on vehicle
2: Further shock information unavailable at the time of print

PACCAR Parts recommends Fleetline™ shocks for budget conscious customers. For customers operating on washboard roads or who want maximum ride-control, an upgrade to TRP® GS shocks is recommended. Customers who want the highest-quality ride and the longest-lasting shock absorber should order the PACCAR® OE Plus shock.

OEM Part Number	Description	PACCAR OE Plus	Position	TRP® Gas	Position	Fleetline	Position
58913-009	Vision Models with Hendrickson Airtek Front Air Suspension					85959	Front
58913-009	Vision Models with Hendrickson Softek Suspension with Steertek Axle					85959	Front
60998-001	Vision Models with Comfort Air Suspensions					85337	Rear

BLUE BIRD WANDERLODGE

1722214	WanderLodge with Reyco Air Suspension			89440	Rear	85030	Rear
1750793	WanderLodge Drive Axle					85712	Rear
90-1951-SP1	WanderLodge LX, LXI - Models Rear					85734	Rear
90-1968-SP1	WanderLodge Front					85712	Front

OTHER BLUE BIRD MODELS

1707405	All Models with Flat Leaf Rear Spring Suspensions (8,200 lb to 10,400 lb)					85321	Rear
303-1350628	Bus with 35" Chassis					85712	Front
90-1968	Bus with 35" Chassis					85712	Front
2021459	School Bus with 3/4" Mounting Pins	665932	Front or Rear	89413	Front or Rear	85012	Front or Rear
614974	Models with OEM Number					85304	Front
680783	Models with OEM Number					85304	Front
300-1316546	Models with OEM Number					85006	Rear
70317	Additional OEM Interchanges			89402	1		
70397	Additional OEM Interchanges					85006	1
0523047	Additional OEM Interchanges					85736	1
671933	Additional OEM Interchanges					85919	2
680155	Additional OEM Interchanges					85712	1
680667	Additional OEM Interchanges			89447	2		
1217934	Additional OEM Interchanges					85304	1
1962422	Additional OEM Interchanges					85304	1
1962430	Additional OEM Interchanges			89407	1	83207	1
4759272	Additional OEM Interchanges			89447	2		
300-0823047	Additional OEM Interchanges					85736	1
300-0823054	Additional OEM Interchanges					85304	1
300-09612284	Additional OEM Interchanges					85734	1
7805-M-1001	Additional OEM Interchanges					85919	2
87001-01A	Additional OEM Interchanges					85734	1
90-1813	Additional OEM Interchanges					85712	1
A-4890	Additional OEM Interchanges					85712	1

Legend:

1: Shock suits Front or Rear application as seen on vehicle
 2: Further shock information unavailable at the time of print

PACCAR Parts recommends Fleetline™ shocks for budget conscious customers. For customers operating on washboard roads or who want maximum ride-control, an upgrade to TRP® GS shocks is recommended. Customers who want the highest-quality ride and the longest-lasting shock absorber should order the PACCAR® OE Plus shock.

BUS & TRUCK CO.

Table 6-6: Bus & Truck Co. Shocks

OEM Part Number	Description	PACCAR OE Plus	Position	TRP® Gas	Position	Fleetline	Position
70039	Silver Eagle Bus	680237	Front or Rear	89422	Front or Rear	85303	Front or Rear
70041	Silver Eagle Bus						
680091	Silver Eagle Bus	680237	1	89422	1	85303	1
0100-905	Silver Eagle Bus					85307	Front or Rear

CARPENTER

Table 6-7: Carpenter Bus Shocks

OEM Part Number	Description	PACCAR OE Plus	Position	TRP® Gas	Position	Fleetline	Position
0272-SS5	Models with OEM Number					85712	Front
63-0001	Models with OEM Number					85713	1

CHEVROLET TRUCK

Table 6-8: Chevrolet Truck Shocks

OEM Part Number	Description	PACCAR OE Plus	Position	TRP® Gas	Position	Fleetline	Position
4, 40, 4000 & 4500 SERIES							
3192892	1967-72 - 4, 40, 4000 & 4500 Series / S-40 School Bus					83221	Front or Rear
3192892	1968 - 4, 40, 4000 & 4500 Series / Cowl - Exc. School Bus					83221	Front or Rear
22012096	1967-72 - 4, 40, 4000 & 4500 Series / S-40 School Bus					83221	Front or Rear
22012096	1968 - 4, 40, 4000 & 4500 Series / Cowl - Exc. School Bus					83221	Front or Rear
5, 50, 5000 & 5500 SERIES							
3192892	1968 - 5, 50, 5000 & 5500 Series / Cowl - Exc. School Bus					83221	Front or Rear

Legend:

1: Shock suits Front or Rear application as seen on vehicle
 2: Further shock information unavailable at the time of print

PACCAR Parts recommends Fleetline™ shocks for budget conscious customers. For customers operating on washboard roads or who want maximum ride-control, an upgrade to TRP® GS shocks is recommended. Customers who want the highest-quality ride and the longest-lasting shock absorber should order the PACCAR® OE Plus shock.

OEM Part Number	Description	PACCAR OE Plus	Position	TRP® Gas	Position	Fleetline	Position
3192892	1969-72 - 5, 50, 5000 & 5500 Series / S-50 School Bus					83221	Front or Rear
3192892	1973-78 - 5, 50, 5000 & 5500 Series / S-50 School Bus					83221	Front or Rear
3192892	1973-80 - 5, 50, 5000 & 5500 Series / C, S Chassis - Conventional Cab and School Bus					83221	Front or Rear
22012095	1973-89 - 5, 50, 5000 & 5500 Series / C, S Chassis - Conventional Cab and School Bus			89430	Front or Rear	85005	Front or Rear
22012096	1968 - 5, 50, 5000 & 5500 Series / Cowl - Exc. School Bus					83221	Front or Rear
22012096	1973-80 - 5, 50, 5000 & 5500 Series / C, S Chassis - Conventional Cab and School Bus					83221	Front or Rear
22012166	1973-78 - 5, 50, 5000 & 5500 Series / S-50 School Bus			89430	Rear	85005	Rear
22012166	1973-89 - 5, 50, 5000 & 5500 Series / C, S Chassis - Conventional Cab and School Bus			89430	Rear	85005	Rear

6, 60, 6000 & 6500 SERIES

3192890	1973-80 - 6, 60, 6000 & 6500 Series / C, S, T Chassis - Conventional & Tilt Cab and School Bus with 5000 & 7000 lb Axle					85005	Front
3192890	1973-80 - 6, 60, 6000 & 6500 Series / C, S, T Chassis - Conventional & Tilt Cab and School Bus with 5000 & 7000 lb Axle			89430	Front		
3192892	1968 - 6, 60, 6000 & 6500 Series / Cowl - Exc. School Bus					83221	Front or Rear
3192892	1973-89 - 6, 60, 6000 & 6500 Series / C, S Chassis - Conventional Cab and School Bus - Exc. with 20800 & 23000 lb Rear Axle					83221	Front or Rear
4940606	1973-80 - 6, 60, 6000 & 6500 Series / C, S, T Chassis - Conventional & Tilt Cab and School Bus with 5000 & 7000 lb Axle			89430	Front or Rear	85005	Front or Rear
4940606	1973-89 - 6, 60, 6000 & 6500 Series / C, S Chassis - Conventional Cab and School Bus with 20800 & 23000 lb Rear Axles			89430	Front or Rear	85005	Front or Rear
4940662	1973-80 - 6, 60, 6000 & 6500 Series / C, S, T Chassis - Conventional & Tilt Cab and School Bus with 5000 & 7000 lb Axle			89430	Front	85005	Front

Legend:
 1: Shock suits Front or Rear application as seen on vehicle
 2: Further shock information unavailable at the time of print

PACCAR Parts recommends Fleetline™ shocks for budget conscious customers. For customers operating on washboard roads or who want maximum ride-control, an upgrade to TRP® GS shocks is recommended. Customers who want the highest-quality ride and the longest-lasting shock absorber should order the PACCAR® OE Plus shock.

OEM Part Number	Description	PACCAR OE Plus	Position	TRP® Gas	Position	Fleetline	Position
4975467	1973-75 - 6, 60, 6000 & 6500 Series / C, M, S Chassis - Conventional Cab and School Bus with 5000 & 7000 lb Axle					83207	Front
4975467	1973-75 - 6, 60, 6000 & 6500 Series / C, M, S Chassis - Conventional Cab and School Bus with 5000 & 7000 lb Axle			89407	Front		
4975494	1973-75 - 6, 60, 6000 & 6500 Series / C, M, S Chassis - Conventional Cab and School Bus with 5000 & 7000 lb Axle			89407	Front	83207	Front
4975497	1973-80 - 6, 60, 6000 & 6500 Series / C, S, T Chassis - Conventional & Tilt Cab and School Bus with 5000 & 7000 lb Axle			89430	Front	85005	Front
4975510	1975-80 - 6, 60, 6000 & 6500 Series / C, M, S Chassis - Conventional Cab and School Bus					83221	Front
22002293	1973-80 - 6, 60, 6000 & 6500 Series / C, S, T Chassis - Conventional & Tilt Cab and School Bus with 5000 & 7000 lb Axle			89430	Front	85005	Front
22002294	1976-89 - 6, 60, 6000 & 6500 Series / S Chassis - School Bus					83304	Front
22002294	1979-89 - 6, 60, 6000 & 6500 Series / B6P042 School Bus (Axle codes F070, F070D)					83304	Front
22002295	1979-89 - 6, 60, 6000 & 6500 Series / B6P042 School Bus (Axle codes F090, F120D)					83303	Front
22002295	1979-89 - 6, 60, 6000 & 6500 Series / C, S Chassis - Conventional Cab and School Bus					83303	Front
22007701	1973-80 - 6, 60, 6000 & 6500 Series / C, S, T Chassis - Conventional & Tilt Cab and School Bus with 5000 & 7000 lb Axle			89430	Front	85005	Front
22007702	1976-89 - 6, 60, 6000 & 6500 Series / S Chassis - School Bus					83304	Front
22007750	1973-75 - 6, 60, 6000 & 6500 Series / C, M, S Chassis - Conventional Cab and School Bus with 5000 & 7000 lb Axle			89407	Front	83207	Front

Legend:
 1: Shock suits Front or Rear application as seen on vehicle
 2: Further shock information unavailable at the time of print

PACCAR Parts recommends Fleetline™ shocks for budget conscious customers. For customers operating on washboard roads or who want maximum ride-control, an upgrade to TRP® GS shocks is recommended. Customers who want the highest-quality ride and the longest-lasting shock absorber should order the PACCAR® OE Plus shock.

OEM Part Number	Description	PACCAR OE Plus	Position	TRP® Gas	Position	Fleetline	Position
22007751	1973-80 - 6, 60, 6000 & 6500 Series / C, S, T Chassis - Conventional & Tilt Cab and School Bus with 5000 & 7000 lb Axle					83303	Front
22007752	1976-89 - 6, 60, 6000 & 6500 Series / S Chassis - School Bus					83304	Front
22007752	1979-89 - 6, 60, 6000 & 6500 Series / B6P042 School Bus (Axle codes F070, F070D)					83304	Front
22007753	1979-89 - 6, 60, 6000 & 6500 Series / B6P042 School Bus (Axle codes F090, F120D)					83303	Front
22007753	1979-89 - 6, 60, 6000 & 6500 Series / C, S Chassis - Conventional Cab and School Bus					83303	Front
22012095	1973-80 - 6, 60, 6000 & 6500 Series / C, S, T Chassis - Conventional & Tilt Cab and School Bus with 5000 & 7000 lb Axle			89430	Front or Rear	85005	Front or Rear
22012095	1973-89 - 6, 60, 6000 & 6500 Series / C, S Chassis - Conventional Cab and School Bus with 20800 & 23000 lb Rear Axles			89430	Front or Rear	85005	Front or Rear
22012095	1979-89 - 6, 60, 6000 & 6500 Series / B6P042 School Bus with 18500 or 20800 lb Rear Springs			89430	Front or Rear	85005	Front or Rear
22012096	1968 - 6, 60, 6000 & 6500 Series / Cowl - Exc. School Bus					83221	Front or Rear
22012096	1973-89 - 6, 60, 6000 & 6500 Series / C, S Chassis - Conventional Cab and School Bus - Exc. with 20800 & 23000 lb Rear Axle					83221	Front or Rear
22012096	1979-89 - 6, 60, 6000 & 6500 Series / B6P042 School Bus with 15000 lb or 17000 lb Rear Springs					83221	Front or Rear
22012166	1973-89 - 6, 60, 6000 & 6500 Series / C, S Chassis - Conventional Cab and School Bus with 20800 & 23000 lb Rear Axles			89430	Rear	85005	Rear
22012166	1979-89 - 6, 60, 6000 & 6500 Series / B6P042 School Bus with 18500 or 20800 lb Rear Springs			89430	Rear	85005	Rear
22012169	1973-89 - 6, 60, 6000 & 6500 Series / C, S Chassis - Conventional Cab and School Bus - Exc. with 20800 & 23000 lb Rear Axle					83221	Rear
22012169	1979-89 - 6, 60, 6000 & 6500 Series / B6P042 School Bus with 15000 lb or 17000 lb Rear Springs					83221	Rear

Legend:
1: Shock suits Front or Rear application as seen on vehicle
2: Further shock information unavailable at the time of print

PACCAR Parts recommends Fleetline™ shocks for budget conscious customers. For customers operating on washboard roads or who want maximum ride-control, an upgrade to TRP® GS shocks is recommended. Customers who want the highest-quality ride and the longest-lasting shock absorber should order the PACCAR® OE Plus shock.

OEM Part Number	Description	PACCAR OE Plus	Position	TRP® Gas	Position	Fleetline	Position
22017530	1979-89 - 6, 60, 6000 & 6500 Series / C, S Chassis - Conventional Cab and School Bus					83303	Front
22017531	1979-89 - 6, 60, 6000 & 6500 Series / B6P042 School Bus (Axle codes F090, F120D)					83303	Front
22017531	1979-89 - 6, 60, 6000 & 6500 Series / C, S Chassis - Conventional Cab and School Bus					83303	Front

7, 70 & 7000 SERIES

5552451	1973-80 - 7, 70 & 7000 Series / R Chassis - Rear Engine Bus	680242	Front	89422	Front	85308	Front
5552456	1973-80 - 7, 70 & 7000 Series / R Chassis - Rear Engine Bus					85307	Rear
5552552	1973-80 - 7, 70 & 7000 Series / R Chassis - Rear Engine Bus	680237	Rear	89422	Rear	85303	Rear
22012090	1973-80 - 7, 70 & 7000 Series / R Chassis - Rear Engine Bus	680242	Front	89422	Front	85308	Front

8, 80 & 8000 SERIES

5552451	1973-80 - 8, 80 & 8000 Series / R Chassis - Rear Engine Bus	680242	Front	89422	Front	85308	Front
5552452	1973-80 - 8, 80 & 8000 Series / R Chassis - Rear Engine Bus	680237	Rear	89422	Rear	85303	Rear
5552456	1973-80 - 8, 80 & 8000 Series / R Chassis - Rear Engine Bus					85307	Rear
22012090	1973-80 - 8, 80 & 8000 Series / R Chassis - Rear Engine Bus	680242	Front	89422	Front	85308	Front
22012091	1973-80 - 8, 80 & 8000 Series / R Chassis - Rear Engine Bus	680237	Rear	89422	Rear	85303	Rear

B - SERIES

15174902	1990-06 - B - Series / B7 School Bus Chassis With 15000, 19000, 21000 lb Multileaf Springs					85071	Rear
22064231	1990-98 - B - Series / B7 School Bus Chassis With 11000, 13500, 15000 lb Taperleaf Springs					85324	Rear
22064232	1990-06 - B - Series / B7 School Bus Chassis With 15000, 19000, 21000 lb Multileaf Springs					85071	Rear

Legend:
1: Shock suits Front or Rear application as seen on vehicle
2: Further shock information unavailable at the time of print

PACCAR Parts recommends Fleetline™ shocks for budget conscious customers. For customers operating on washboard roads or who want maximum ride-control, an upgrade to TRP® GS shocks is recommended. Customers who want the highest-quality ride and the longest-lasting shock absorber should order the PACCAR® OE Plus shock.

CONTINENTAL TRAILWAYS - EAGLE INTERNATIONAL

Table 6-9: Continental Trailways - Eagle International Shocks

OEM Part Number	Description	PACCAR OE Plus	Position	TRP® Gas	Position	Fleetline	Position
6-05-5	Models with OEM Number					85307	Front or Rear

DINA BUS

Table 6-10: Dina Bus Shocks

OEM Part Number	Description	PACCAR OE Plus	Position	TRP® Gas	Position	Fleetline	Position
39380353-6	Marco Polo Viaggio GV 1000 Front Shock					85716	Front
39390340-4	Marco Polo Viaggio GV 1000 Tag Axle					85716	Rear

DODGE TRUCK

Table 6-11: Dodge Truck Shocks

OEM Part Number	Description	PACCAR OE Plus	Position	TRP® Gas	Position	Fleetline	Position
2516009	1972-73 - School Buses / S-500, S-600					G60028	Rear
3633643	1974-78 - School Buses / S-600, S-700					G60028	Rear

Legend:
 1: Shock suits Front or Rear application as seen on vehicle
 2: Further shock information unavailable at the time of print

PACCAR Parts recommends Fleetline™ shocks for budget conscious customers. For customers operating on washboard roads or who want maximum ride-control, an upgrade to TRP® GS shocks is recommended. Customers who want the highest-quality ride and the longest-lasting shock absorber should order the PACCAR® OE Plus shock.

EAGLE MOTOR COACH

Table 6-12: Eagle Motor Coach Shocks

OEM Part Number	Description	PACCAR OE Plus	Position	TRP® Gas	Position	Fleetline	Position
6-05-5	Buses with Rubber Torsion Suspension					85307	Front or Rear
5532026	Buses with Steel Spring Suspension					85304	Front or Rear

FLXIBLE BUS

Table 6-13: Flxible Bus Shocks

OEM Part Number	Description	PACCAR OE Plus	Position	TRP® Gas	Position	Fleetline	Position
6-05-1	City Bus - 51 Passenger					85736	Front or Rear
6-05-1	City Bus - 51 Passenger with Rubber Torsion Suspension					85736	Front or Rear
6-05-2	City Bus - 51 Passenger					85736	Front or Rear
6-05-2	City Bus - 51 Passenger with Rubber Torsion Suspension					85736	Front or Rear
6-05-3	City Bus - 51 Passenger					85736	Front or Rear
6-05-3	City Bus - 51 Passenger with Rubber Torsion Suspension					85736	Front or Rear
6-05-4	City Bus - 51 Passenger					85736	Front or Rear
6-05-4	City Bus - 51 Passenger with Rubber Torsion Suspension					85736	Front or Rear
6-05-5	City Bus - 51 Passenger					85307	Front or Rear
6-05-5	City Bus - 51 Passenger with Rubber Torsion Suspension					85307	Front or Rear
6-05-6	City Bus - 51 Passenger					85736	Front or Rear
6-05-6	City Bus - 51 Passenger with Rubber Torsion Suspension					85736	Front or Rear
6-05-7	City Bus - 51 Passenger					85736	Front or Rear
6-05-7	City Bus - 51 Passenger with Rubber Torsion Suspension					85736	Front or Rear
6-05-8	City Bus - 51 Passenger					85736	Front or Rear
6-05-8	City Bus - 51 Passenger with Rubber Torsion Suspension					85736	Front or Rear

Legend:
 1: Shock suits Front or Rear application as seen on vehicle
 2: Further shock information unavailable at the time of print

PACCAR Parts recommends Fleetline™ shocks for budget conscious customers. For customers operating on washboard roads or who want maximum ride-control, an upgrade to TRP® GS shocks is recommended. Customers who want the highest-quality ride and the longest-lasting shock absorber should order the PACCAR® OE Plus shock.

OEM Part Number	Description	PACCAR OE Plus	Position	TRP® Gas	Position	Fleetline	Position
CNG Bus							
87-2519-00002	CNG Bus (Natural Gas)					85731	Front
87-2519-00004	CNG Bus (Natural Gas)					85731	Front
87-2520-00002	CNG Bus (Natural Gas)					85730	Rear
87-2520-00004	CNG Bus (Natural Gas)					85730	Rear
97-2201-00008	CNG Bus (Natural Gas)					85731	Front
97-2210-00010	CNG Bus (Natural Gas)					85730	Rear

FLXIBLE MODEL 870

74412	Model 870 Flxible Bus, Metro					85704	Rear
4975518	Model 870 Flxible Bus, Metro					85704	Rear
22024062	Model 870 Flxible Bus, Metro					85701	Front
22024506	Model 870 Flxible Bus, Metro					85703	Front
22025066	Model 870 Flxible Bus, Metro					85703	Front
87-2519-00001	Model 870 Flxible Bus, Metro					85703	Front
87-2519-00003	Model 870 Flxible Bus, Metro					85703	Front
87-2520-00001	Model 870 Flxible Bus, Metro					85704	Rear
87-2520-00003	Model 870 Flxible Bus, Metro					85704	Rear
97-2201-00003	Model 870 Flxible Bus, Metro					85703	Front
97-2201-00005	Model 870 Flxible Bus, Metro					85703	Front
97-2201-00006	Model 870 Flxible Bus, Metro					85703	Front
97-2201-00007	Model 870 Flxible Bus, Metro					85703	Front
97-2201-00009	Model 870 Flxible Bus, Metro					85703	Front
97-2210-00001	Model 870 Flxible Bus, Metro					85704	Rear
97-2210-00002	Model 870 Flxible Bus, Metro					85704	Rear
97-2210-00003	Model 870 Flxible Bus, Metro					85704	Rear
97-2210-00004	Model 870 Flxible Bus, Metro					85704	Rear
97-2210-00005	Model 870 Flxible Bus, Metro					85704	Rear
97-2210-00006	Model 870 Flxible Bus, Metro					85704	Rear
97-2210-00009	Model 870 Flxible Bus, Metro					85704	Rear
97-2210-00011	Model 870 Flxible Bus, Metro					85704	Rear

OTHER FLXIBLE MODELS

6-05-9	Models with OEM Number					85304	Front
6-05-13	Models with OEM Number					85304	Rear
695125	Models with OEM Number					85704	Rear
3166657	Models with OEM Number					85700	1
3192333	Models with OEM Number					85700	Front or Rear

Legend:
 1: Shock suits Front or Rear application as seen on vehicle
 2: Further shock information unavailable at the time of print

PACCAR Parts recommends Fleetline™ shocks for budget conscious customers. For customers operating on washboard roads or who want maximum ride-control, an upgrade to TRP® GS shocks is recommended. Customers who want the highest-quality ride and the longest-lasting shock absorber should order the PACCAR® OE Plus shock.

OEM Part Number	Description	PACCAR OE Plus	Position	TRP® Gas	Position	Fleetline	Position
22012067	Models with OEM Number					85700	Front or Rear
22012114	Models with OEM Number					85700	Front or Rear
22024061	Models with OEM Number					85704	Rear
22025067	Models with OEM Number					85704	Rear
22025305	Models with OEM Number					85704	Rear
6-367-12	Models with OEM Number					85700	Front or Rear
6-367-14	Models with OEM Number					85700	Front or Rear
6-367-16	Models with OEM Number					85700	Front or Rear
6-367-8	Models with OEM Number					85700	Front or Rear
87-2519-00001	Models with OEM Number					85703	Front
97-2201-00001	Models with OEM Number					85703	Front
97-2201-00002	Models with OEM Number					85703	Front
97-2201-00004	Models with OEM Number					85703	Front
97-2201-00151	Models with OEM Number					85700	Front or Rear
97-2210-00170	Models with OEM Number					85733	Front or Rear
97-9999-02592	Models with OEM Number					85710	Front
015813	Additional OEM Interchanges					85708	1
6-05-10	Additional OEM Interchanges					85734	1
680029	Additional OEM Interchanges					85301	1
680155	Additional OEM Interchanges					85712	1
06-0367-00151	Additional OEM Interchanges					85700	1
06-0367-00156	Additional OEM Interchanges					85702	1
06-0367-00157	Additional OEM Interchanges					85701	1
48-1-239	Additional OEM Interchanges					85736	1
48-1-241	Additional OEM Interchanges					85712	1
6-367-1	Additional OEM Interchanges					85711	1
6-367-11	Additional OEM Interchanges					85711	1
6-367-17	Additional OEM Interchanges					85700	1
6-367-2	Additional OEM Interchanges					85736	1
6-367-3	Additional OEM Interchanges					85304	1
6-367-4	Additional OEM Interchanges					83217	1
6-367-6	Additional OEM Interchanges					85711	1
6-367-7	Additional OEM Interchanges					85305	1
6-367-9	Additional OEM Interchanges					85711	1
97-2210-00153	Additional OEM Interchanges					85701	1
97-2210-00156	Additional OEM Interchanges					85702	1
97-2210-00157	Additional OEM Interchanges					85708	1
97-2210-00160	Additional OEM Interchanges			89447	1	85705	1

Legend:
 1: Shock suits Front or Rear application as seen on vehicle
 2: Further shock information unavailable at the time of print

PACCAR Parts recommends Fleetline™ shocks for budget conscious customers. For customers operating on washboard roads or who want maximum ride-control, an upgrade to TRP® GS shocks is recommended. Customers who want the highest-quality ride and the longest-lasting shock absorber should order the PACCAR® OE Plus shock.

OEM Part Number	Description	PACCAR OE Plus	Position	TRP® Gas	Position	Fleetline	Position
97-2210-00162	Additional OEM Interchanges					85701	1
97-2210-00164	Additional OEM Interchanges					85708	1
97-9999-00732	Additional OEM Interchanges					85707	1
97-9999-02514	Additional OEM Interchanges					85700	1
97-9999-02515	Additional OEM Interchanges					85702	1
97-9999-02516	Additional OEM Interchanges					85701	1
97-9999-02519	Additional OEM Interchanges					85707	1
97-9999-02595	Additional OEM Interchanges					85313	1
97-9999-02632	Additional OEM Interchanges					85711	1
97-9999-02633	Additional OEM Interchanges	680586	1	89424	1	85311	1
97-9999-02634	Additional OEM Interchanges					85733	1
97-9999-02635	Additional OEM Interchanges					85718	1
97-9999-02636	Additional OEM Interchanges					85716	1
97-9999-807	Additional OEM Interchanges					85307	1

FORD

Table 6-14: Ford Shocks

OEM Part Number	Description	PACCAR OE Plus	Position	TRP® Gas	Position	Fleetline	Position
C2TA-18045-A	1961-69 - B - Series - Bus Cowl Chassis / B - 500, B - 600, B - 700, B - 750 with 6000 & 7000 lb Axle					83216	Front
D2TF-18045-GA	1970-79 - B - Series - Bus Cowl Chassis / B - 500, B - 600, B - 700, B - 750					83308	Front
D2TF-18080-HA	1961-79 - B - Series - Bus Cowl Chassis / B - 500, B - 600, B - 700, B - 750					83225	Rear

Legend:
 1: shock suits Front or Rear application as seen on vehicle
 2: further shock information unavailable at the time of print

PACCAR Parts recommends Fleetline™ shocks for budget conscious customers. For customers operating on washboard roads or who want maximum ride-control, an upgrade to TRP® GS shocks is recommended. Customers who want the highest-quality ride and the longest-lasting shock absorber should order the PACCAR® OE Plus shock.

OEM Part Number	Description	PACCAR OE Plus	Position	TRP® Gas	Position	Fleetline	Position
D7HT-18045-GA	1970-79 - B - Series - Bus Cowl Chassis / B - 500, B - 600, B - 700, B - 750					83308	Front
D7HT-18080-AA	1977-96 - B - Series - Bus Cowl Chassis / B - 600, B - 700, B - 750, B - 800, B - 7000 with 18500 lb Axle					83215	Rear
D7HT-18080-BA	1961-79 - B - Series - Bus Cowl Chassis / B - 500, B - 600, B - 700, B - 750					83225	Rear
D7HT-18080-DA	1977-79 - B - Series - Bus Cowl Chassis / B - 600, B - 750, with 18500 lb Axle					83215	Rear
D7HT-18080-DA	1980-96 - B - Series - Bus Cowl Chassis / B - 600, B - 700, B - 800, B - 7000					83215	Rear
E0HT-18045-AA	1980-96 - B - Series - Bus Cowl Chassis / B - 600, B - 700, B - 800, B - 7000			89446	Front	83309	Front
E0HT-18045-AB	1980-96 - B - Series - Bus Cowl Chassis / B - 600, B - 700, B - 800, B - 7000			89446	Front	83309	Front
E0HT-18080-AA	1980-96 - B - Series - Bus Cowl Chassis / B - 600, B - 700, B - 800, B - 7000					83215	Rear
E0HT-18080-AA	1986-90 - B - Series - Bus Cowl Chassis / B - 600, B - 700, B - 800, B - 7000					83215	Rear
F1HT-18045-AA	1980-96 - B - Series - Bus Cowl Chassis / B - 600, B - 700, B - 800, B - 7000			89446	Front	83309	Front

FREIGHTLINER CUSTOM CHASSIS

Table 6-15: Freightliner Shocks

OEM Part Number	Description	PACCAR OE Plus	Position	TRP® Gas	Position	Fleetline	Position
6803230300	F65 School bus chassis					85006	Front
6803260000	F65 School bus chassis					83120	Rear
GBL654725	F65 School bus chassis					83120	Rear
GBL665538	F65 School bus chassis					85006	Front

SCHOOL BUSES

16-15676-000	MB55 Shuttle bus with 8000 lb. flat leaf front suspension			89431	Front	85058	Front
16-16082-000	Shuttle Bus Chassis					85043	Front

Legend:
 1: shock suits Front or Rear application as seen on vehicle
 2: further shock information unavailable at the time of print

PACCAR Parts recommends Fleetline™ shocks for budget conscious customers. For customers operating on washboard roads or who want maximum ride-control, an upgrade to TRP® GS shocks is recommended. Customers who want the highest-quality ride and the longest-lasting shock absorber should order the PACCAR® OE Plus shock.

GILLIG LLC

Table 6-16: Gillig LLC Shocks

OEM Part Number	Description	PACCAR OE Plus	Position	TRP® Gas	Position	Fleetline	Position
SCHOOL BUSES							
57113	School Bus with 3/4" Mounting Pins					83219	Front
57131	School Bus with 3/4" Mounting Pins					83216	Rear
200-171	School Bus with 1" Mounting Pins					85304	Front or Rear
53-176	School Bus with 1" Mounting Pins					85304	Front or Rear

TRANSIT BUSES

695110	Transit Bus, Phantom 55, 40, TB40					85318	Rear
53-14010	Transit Bus, Phantom 55, 40, TB40					85318	Rear
53-24685	Transit Bus, Phantom 55, 40, TB40					85723	Front
90F-1912	Transit Bus, Phantom 55, 40, TB40					85318	Rear
680333	Additional OEM Interchanges					85708	2

GMC TRUCK

Table 6-17: GMC Truck Shocks

OEM Part Number	Description	PACCAR OE Plus	Position	TRP® Gas	Position	Fleetline	Position
5000 SERIES							
3192892	1973-80 - 5000 Series / C,S Chassis - Conventional Cab and School Bus					83221	Front or Rear
22012095	1973-89 - 5000 Series / C,S Chassis - Conventional Cab and School Bus			89430	Front or Rear	85005	Front or Rear
22012096	1973-80 - 5000 Series / C,S Chassis - Conventional Cab and School Bus					83221	Front or Rear
22012166	1973-89 - 5000 Series / C,S Chassis - Conventional Cab and School Bus			89430	Rear	85005	Rear
6000 SERIES							
3192890	1973-80 - 6000 Series / C, S, T Chassis - Conventional & Tilt Cab and School Bus with 5000 & 7000 lb Axle			89430	Front	85005	Front

Legend:
 1: shock suits Front or Rear application as seen on vehicle
 2: further shock information unavailable at the time of print

PACCAR Parts recommends Fleetline™ shocks for budget conscious customers. For customers operating on washboard roads or who want maximum ride-control, an upgrade to TRP® GS shocks is recommended. Customers who want the highest-quality ride and the longest-lasting shock absorber should order the PACCAR® OE Plus shock.

OEM Part Number	Description	PACCAR OE Plus	Position	TRP® Gas	Position	Fleetline	Position
3192892	1973-89 - 6000 Series / C, S Chassis - Conventional Cab and School Bus - Exc. with 18500, 20800 & 23000 lb Rear Axle					83221	Front or Rear
4940606	1973-80 - 6000 Series / C, S, T Chassis - Conventional & Tilt Cab and School Bus with 5000 & 7000 lb Axle			89430	Front or Rear	85005	Front or Rear
4940606	1973-89 - 6000 Series / C, S Chassis - Conventional Cab and School Bus with 18500, 20800 & 23000 lb Rear Axle			89430	Front or Rear	85005	Front or Rear
4940662	1973-80 - 6000 Series / C, S, T Chassis - Conventional & Tilt Cab and School Bus with 5000 & 7000 lb Axle			89430	Front	85005	Front
4975467	1973-75 - 6000 Series / C, S Chassis - Conventional Cab and School Bus - Exc. with 18500, 20800 & 23000 lb Rear Axle			89407	Front	83207	Front
4975494	1973-75 - 6000 Series / C, S Chassis - Conventional Cab and School Bus - Exc. with 18500, 20800 & 23000 lb Rear Axle			89407	Front	83207	Front
4975497	1973-80 - 6000 Series / C, S, T Chassis - Conventional & Tilt Cab and School Bus with 5000 & 7000 lb Axle			89430	Front	85005	Front
4975510	1975-80 - 6000 Series / C, S Chassis - Conventional Cab and School Bus					83221	Front
22002293	1973-80 - 6000 Series / C, S, T Chassis - Conventional & Tilt Cab and School Bus with 5000 & 7000 lb Axle			89430	Front	85005	Front
22002294	1979-89 - 6000 Series / S Chassis - School Bus					83304	Front
22002295	1979-89 - 6000 Series / C, S Chassis - Conventional Cab and School Bus					83303	Front
22007701	1973-80 - 6000 Series / C, S, T Chassis - Conventional & Tilt Cab and School Bus with 5000 & 7000 lb Axle			89430	Front	85005	Front
22007702	1976-89 - 6000 Series / S Chassis - School Bus					83304	Front
22007750	1973-75 - 6000 Series / C, S Chassis - Conventional Cab and School Bus - Exc. with 18500, 20800 & 23000 lb Rear Axle			89407	Front	83207	Front

Legend:
 1: shock suits Front or Rear application as seen on vehicle
 2: further shock information unavailable at the time of print

PACCAR Parts recommends Fleetline™ shocks for budget conscious customers. For customers operating on washboard roads or who want maximum ride-control, an upgrade to TRP® GS shocks is recommended. Customers who want the highest-quality ride and the longest-lasting shock absorber should order the PACCAR® OE Plus shock.

OEM Part Number	Description	PACCAR OE Plus	Position	TRP® Gas	Position	Fleetline	Position
22007751	1973-80 - 6000 Series / C, S, T Chassis - Conventional & Tilt Cab and School Bus with 5000 & 7000 lb Axle					83303	Front
22007752	1979-89 - 6000 Series / S Chassis - School Bus					83304	Front
22007753	1979-89 - 6000 Series / C, S Chassis - Conventional Cab and School Bus					83303	Front
22007757	1979-89 - 6000 Series / S Chassis - School Bus					83304	Front
22012095	1973-80 - 6000 Series / C, S, T Chassis - Conventional & Tilt Cab and School Bus with 5000 & 7000 lb Axle			89430	Front or Rear	85005	Front or Rear
22012095	1973-89 - 6000 Series / C, S Chassis - Conventional Cab and School Bus with 18500, 20800 & 23000 lb Rear Axle			89430	Front or Rear	85005	Front or Rear
22012096	1973-89 - 6000 Series / C, S Chassis - Conventional Cab and School Bus - Exc. with 18500, 20800 & 23000 lb Rear Axle					83221	Front or Rear
22012166	1973-89 - 6000 Series / C, S Chassis - Conventional Cab and School Bus with 18500, 20800 & 23000 lb Rear Axle			89430	Rear	85005	Rear
22012169	1973-89 - 6000 Series / C, S Chassis - Conventional Cab and School Bus - Exc. with 18500, 20800 & 23000 lb Rear Axle					83221	Rear
22017530	1979-89 - 6000 Series / C, S Chassis - Conventional Cab and School Bus					83303	Front
22017531	1979-89 - 6000 Series / C, S Chassis - Conventional Cab and School Bus					83303	Front

6500 SERIES

3192890	1973-80 - 6500 Series / C, S, T Chassis - Conventional & Tilt Cab and School Bus			89430	Front	85005	Front
3192892	1973-80 - 6500 Series / C, M, S Chassis - Conventional Cab and School Bus - Exc. with 20800 or 23000 lb Rear Axle					83221	Front or Rear
4940606	1973-80 - 6500 Series / C, M, S Chassis - Conventional Cab and School Bus with 20800 or 23000 lb Rear Axle			89430	Front or Rear	85005	Front or Rear

Legend:

- 1: shock suits Front or Rear application as seen on vehicle
2: further shock information unavailable at the time of print

PACCAR Parts recommends Fleetline™ shocks for budget conscious customers. For customers operating on washboard roads or who want maximum ride-control, an upgrade to TRP® GS shocks is recommended. Customers who want the highest-quality ride and the longest-lasting shock absorber should order the PACCAR® OE Plus shock.

OEM Part Number	Description	PACCAR OE Plus	Position	TRP® Gas	Position	Fleetline	Position
4940606	1973-80 - 6500 Series / C, S, T Chassis - Conventional & Tilt Cab and School Bus			89430	Front or Rear	85005	Front or Rear
4975467	1973-75 - 6500 Series / C, M, S Chassis - Conventional Cab and School Bus			89407	Front	83207	Front
4975494	1973-75 - 6500 Series / C, M, S Chassis - Conventional Cab and School Bus			89407	Front	83207	Front
4975497	1973-80 - 6500 Series / C, S, T Chassis - Conventional & Tilt Cab and School Bus			89430	Front	85005	Front
22002293	1973-80 - 6500 Series / C, S, T Chassis - Conventional & Tilt Cab and School Bus			89430	Front	85005	Front
22007750	1973-75 - 6500 Series / C, M, S Chassis - Conventional Cab and School Bus			89407	Front	83207	Front
22012095	1973-80 - 6500 Series / C, M, S Chassis - Conventional Cab and School Bus with 20800 or 23000 lb Rear Axle			89430	Front or Rear	85005	Front or Rear
22012095	1973-80 - 6500 Series / C, S, T Chassis - Conventional & Tilt Cab and School Bus			89430	Front or Rear	85005	Front or Rear
22012096	1973-80 - 6500 Series / C, M, S Chassis - Conventional Cab and School Bus - Exc. with 20800 or 23000 lb Rear Axle					83221	Front or Rear
22012166	1973-80 - 6500 Series / C, M, S Chassis - Conventional Cab and School Bus with 20800 or 23000 lb Rear Axle			89430	Rear	85005	Rear
22012169	1973-80 - 6500 Series / C, M, S Chassis - Conventional Cab and School Bus - Exc. with 20800 or 23000 lb Rear Axle					83221	Rear

7500 SERIES

5552451	1973-80 - 7500 Series / R Chassis - Rear Engine Bus	680242	Front	89422	Front	85308	Front
5552452	1973-80 - 7500 Series / R Chassis - Rear Engine Bus	680237	Rear	89422	Rear	85303	Rear
5552456	1973-80 - 7500 Series / R Chassis - Rear Engine Bus					85307	Rear
22012090	1973-80 - 7500 Series / R Chassis - Rear Engine Bus	680242	Front	89422	Front	85308	Front

Legend:

- 1: shock suits Front or Rear application as seen on vehicle
2: further shock information unavailable at the time of print

PACCAR Parts recommends Fleetline™ shocks for budget conscious customers. For customers operating on washboard roads or who want maximum ride-control, an upgrade to TRP® GS shocks is recommended. Customers who want the highest-quality ride and the longest-lasting shock absorber should order the PACCAR® OE Plus shock.

OEM Part Number	Description	PACCAR OE Plus	Position	TRP® Gas	Position	Fleetline	Position
22012091	1973-80 - 7500 Series / R Chassis - Rear Engine Bus	680237	Rear	89422	Rear	85303	Rear

8500 SERIES

5552451	1973-80 - 8500 Series / R Chassis - Rear Engine Bus	680242	Front	89422	Front	85308	Front
5552452	1973-80 - 8500 Series / R Chassis - Rear Engine Bus	680237	Rear	89422	Rear	85303	Rear
5552456	1973-80 - 8500 Series / R Chassis - Rear Engine Bus					85307	Rear
22012090	1973-80 - 8500 Series / R Chassis - Rear Engine Bus	680242	Front	89422	Front	85308	Front
22012091	1973-80 - 8500 Series / R Chassis - Rear Engine Bus	680237	Rear	89422	Rear	85303	Rear

B - SERIES

15174902	1990-06 - B - Series / B7 School Bus Chassis With 15000, 19000, 21000 lb Multileaf Springs					85071	Rear
22064231	1990-98 - B - Series / B7 School Bus Chassis With 11000, 13500, 15000 lb Taperleaf Springs					85324	Rear
22064232	1990-06 - B - Series / B7 School Bus Chassis With 15000, 19000, 21000 lb Multileaf Springs					85071	Rear

GREYHOUND BUS

Table 6-18: Greyhound Bus Shocks

OEM Part Number	Description	PACCAR OE Plus	Position	TRP® Gas	Position	Fleetline	Position
12 TA-01-013	City Cruiser	680237	Front or Rear	89422	Front or Rear	85303	Front or Rear
3178157	MC5, MC7, MC8					85700	Front or Rear
12B-5-1	MC5, MC7, MC8					85700	1
690029	Additional OEM Interchanges					85700	1
3166657	Additional OEM Interchanges					85700	1
3178154	Additional OEM Interchanges					85735	1
3192333	Additional OEM Interchanges					85700	1
5316984	Additional OEM Interchanges					85313	1

Legend:
 1: shock suits Front or Rear application as seen on vehicle
 2: further shock information unavailable at the time of print

PACCAR Parts recommends Fleetline™ shocks for budget conscious customers. For customers operating on washboard roads or who want maximum ride-control, an upgrade to TRP® GS shocks is recommended. Customers who want the highest-quality ride and the longest-lasting shock absorber should order the PACCAR® OE Plus shock.

GRUMMAN BUS

Table 6-19: Grumman Bus Shocks

OEM Part Number	Description	PACCAR OE Plus	Position	TRP® Gas	Position	Fleetline	Position
22024506	Model 870 Flex Bus					85703	Front
22025066	Model 870 Flex Bus					85703	Front
22025067	Model 870 Flex Bus					85704	Rear
22025305	Model 870 Flex Bus					85704	Rear
97-2201-00001	Model 870 Flex Bus					85703	Front
97-2201-00002	Model 870 Flex Bus					85703	Front
97-2201-00003	Model 870 Flex Bus					85703	Front
97-2201-00004	Model 870 Flex Bus					85703	Front
97-2201-00005	Model 870 Flex Bus					85703	Front
97-2210-00001	Model 870 Flex Bus					85704	Rear
97-2210-00002	Model 870 Flex Bus					85704	Rear
97-2210-00003	Model 870 Flex Bus					85704	Rear
97-2210-00004	Model 870 Flex Bus					85704	Rear
97-2210-00005	Model 870 Flex Bus					85704	Rear

HIGHWAY PRODUCT

Table 6-20: Highway Product Shocks

OEM Part Number	Description	PACCAR OE Plus	Position	TRP® Gas	Position	Fleetline	Position
A1-6-134	Transit Bus with Leaf Spring Suspension			89407	Rear	83207	Rear
A1-6-135	Transit Bus with Leaf Spring Suspension			89436	Front	83203	Front

INTERNATIONAL/ IC BUS

Table 6-21: International/ IC Bus Shocks

OEM Part Number	Description	PACCAR OE Plus	Position	TRP® Gas	Position	Fleetline	Position
3605735C1	School Bus / BE200 Small Bus Chassis with 7000 lb Axle					83156	Front

Legend:
 1: shock suits Front or Rear application as seen on vehicle
 2: further shock information unavailable at the time of print

PACCAR Parts recommends Fleetline™ shocks for budget conscious customers. For customers operating on washboard roads or who want maximum ride-control, an upgrade to TRP® GS shocks is recommended. Customers who want the highest-quality ride and the longest-lasting shock absorber should order the PACCAR® OE Plus shock.

OEM Part Number	Description	PACCAR OE Plus	Position	TRP® Gas	Position	Fleetline	Position
3605735C2	School Bus / BE200 Small Bus Chassis with 7000 lb Axle					83156	Front

DURASTAR - 4300, 4400 SERIES

3533356C1	DuraStar - 4300, 4400 Series / School Bus models with 8,000 lb Front axle					83135	Front
3533356C2	DuraStar - 4300, 4400 Series / School Bus models with 8,000 lb Front axle					83135	Front

S SERIES SCHOOL BUS

1675455C1	S Series School Bus / 1723, 1823, 1853 Series with International Air Suspension	680281	Rear	89411	Rear	85003	Rear
1690035C1	S Series School Bus / 1723, 1823, 1853 Series with International Air Suspension	680281	Rear	89411	Rear	85003	Rear
2018987C1	S Series School Bus / 1723, 1823, 1853 Series with International Air Suspension	680281	Rear	89411	Rear	85003	Rear
204994R91	S Series School Bus / 173 FC, 183 FC, 183RE, 193 RE					83225	Front
204994R91	S Series School Bus / 1853 FC & 1853 DFC					83225	Front
206620R91	S Series School Bus / 1603, 1703, 1803 & 1853					83216	Front or Rear
206620R91	S Series School Bus / 1603, 1703, 1803 & 1853 with Axle Codes 02089, 02091					83216	Front or Rear
206621R91	S Series School Bus / 1603, 1703, 1803 & 1853					83216	Rear
208664C91	S Series School Bus / 1853 FC & 1853 DFC with Axle Codes 14044, 14045, 14060, 14145, 14146, 14150 and 14186					85307	Rear
210533R91	S Series School Bus / 183 RE with Axle Codes 14043, 14147 & 14186					83225	Rear
210533R91	S Series School Bus / 193 RE - Exc. Axle Codes 14039 & 14189					83225	Rear
210533R91	S Series School Bus / 1853 FC & 1853 DFC with Axle Codes 14039, 14139, 14149 & 14189 - Exc. 14149 with FD Serial Numbers					83225	Rear
210534R92	S Series School Bus / 183 RE with Axle Codes 14043, 14147 & 14186					83225	Rear
210534R92	S Series School Bus / 193 RE - Exc. Axle Codes 14039 & 14189					83225	Rear
210534R92	S Series School Bus / 1853 FC & 1853 DFC with Axle Codes 14039, 14139, 14149 & 14189 - Exc. 14149 with FD Serial Numbers					83225	Rear
210535R91	S Series School Bus / 173 FC & 183 FC with Axle Codes 14149 & 14189					83225	Rear
210918R91	S Series School Bus / 173 FC & 183 FC - Exc. Axle Codes 14149 & 14189					83215	Rear

Legend:
 1: shock suits Front or Rear application as seen on vehicle
 2: further shock information unavailable at the time of print

PACCAR Parts recommends Fleetline™ shocks for budget conscious customers. For customers operating on washboard roads or who want maximum ride-control, an upgrade to TRP® GS shocks is recommended. Customers who want the highest-quality ride and the longest-lasting shock absorber should order the PACCAR® OE Plus shock.

OEM Part Number	Description	PACCAR OE Plus	Position	TRP® Gas	Position	Fleetline	Position
210919R91	S Series School Bus / 1853 FC & 1853 DFC with Axle Code 14136					85307	Rear
210919R91	S Series School Bus / 1853 FC & 1853 DFC with Axle Codes 14044, 14045, 14060, 14145, 14146, 14150 and 14186					85307	Rear
210920R91	S Series School Bus / 193 RE	680242	Front	89422	Front	85308	Front
210920R91	S Series School Bus / 1853 DFC3	680242	Front	89422	Front	85308	Front
306444C91	S Series School Bus / 1603, 1703, 1803 & 1853	665932	Rear	89413	Rear	85012	Rear
308648C91	S Series School Bus / 173 FC, 183 FC, 183RE, 193 RE					83225	Front
308648C91	S Series School Bus / 1853 FC & 1853 DFC					83225	Front
308649C91	S Series School Bus / 1603, 1703, 1803 & 1853					83216	Front or Rear
308649C91	S Series School Bus / 1603, 1703, 1803 & 1853 with Axle Codes 02089, 02091					83216	Front or Rear
308650C92	S Series School Bus / 1603, 1703, 1803 & 1853					83216	Rear
308664C91	S Series School Bus / 1853 FC & 1853 DFC with Axle Code 14136					85307	Rear
308668C92	S Series School Bus / 1603, 1703, 1803 & 1853 - Exc. Axle Codes 02054, 02057, 02059, 02089, 02091, 02098, 02101, 02109, 02139, 02208, 02218, 02228, 02309, 02329, 02339	665932	Front	89413	Front	85012	Front
320444C91	S Series School Bus / 1603, 1703, 1803 & 1853 with 9000, 10800 or 12000 lb Front Axle	665932	Front	89413	Front	85012	Front
329316C92	S Series School Bus / 1603, 1703, 1803 & 1853	665932	Front or Rear	89413	Front or Rear	85012	Front or Rear
329316C92	S Series School Bus / 1603, 1703, 1803 & 1853 with 9000, 10800 or 12000 lb Front Axle	665932	Front or Rear	89413	Front or Rear	85012	Front or Rear
383379C91	S Series School Bus / 1603, 1703, 1803 & 1853					83308	Rear
453556C91	S Series School Bus / 1603, 1703, 1803 & 1853 - Exc. Axle Codes 02054, 02057, 02059, 02089, 02091, 02098, 02101, 02109, 02139, 02208, 02218, 02228, 02309, 02329, 02339	665932	Front	89413	Front	85012	Front
453561C91	S Series School Bus / 173 FC, 183 FC, 183RE, 193 RE					83225	Front
453561C91	S Series School Bus / 1853 FC & 1853 DFC					83225	Front
453562C91	S Series School Bus / 183 RE with Axle Codes 14043, 14147 & 14186					83225	Rear
453562C91	S Series School Bus / 193 RE - Exc. Axle Codes 14039 & 14189					83225	Rear
453562C91	S Series School Bus / 1853 FC & 1853 DFC with Axle Codes 14039, 14139, 14149 & 14189 - Exc. 14149 with FD Serial Numbers					83225	Rear
453564C91	S Series School Bus / 1603, 1703, 1803 & 1853	665932	Front or Rear	89413	Front or Rear	85012	Front or Rear

Legend:
 1: shock suits Front or Rear application as seen on vehicle
 2: further shock information unavailable at the time of print

PACCAR Parts recommends Fleetline™ shocks for budget conscious customers. For customers operating on washboard roads or who want maximum ride-control, an upgrade to TRP® GS shocks is recommended. Customers who want the highest-quality ride and the longest-lasting shock absorber should order the PACCAR® OE Plus shock.

OEM Part Number	Description	PACCAR OE Plus	Position	TRP® Gas	Position	Fleetline	Position
453564C91	S Series School Bus / 1603, 1703, 1803 & 1853 with 9000, 10800 or 12000 lb Front Axle	665932	Front or Rear	89413	Front or Rear	85012	Front or Rear
453565C91	S Series School Bus / 173 FC, 183 FC, 183RE, 193 RE					83225	Front
453565C91	S Series School Bus / 1853 FC & 1853 DFC					83225	Front
453567C91	S Series School Bus / 1603, 1703, 1803 & 1853					83216	Front or Rear
453567C91	S Series School Bus / 1603, 1703, 1803 & 1853 with Axle Codes 02089, 02091					83216	Front or Rear
453567C91	S Series School Bus / 1853 FC & 1853 DFC with Axle Code 14149 with FD Serial Numbers					83216	Front or Rear
453568C91	S Series School Bus / 173 FC & 183 FC with Axle Codes 14149 & 14189					83225	Rear
453570C91	S Series School Bus / 1603, 1703, 1803 & 1853					83216	Rear
453574C91	S Series School Bus / 173 FC & 183 FC - Exc. Axle Codes 14149 & 14189					85307	Rear
453574C91	S Series School Bus / 1853 FC & 1853 DFC with Axle Code 14136					85307	Rear
453574C91	S Series School Bus / 1853 FC & 1853 DFC with Axle Codes 14044, 14045, 14060, 14145, 14146, 14150 and 14186					85307	Rear
453575C91	S Series School Bus / 1603, 1703, 1803 & 1853					83308	Rear
453579C91	S Series School Bus / 193 RE	680242	Front	89422	Front	85308	Front
453579C91	S Series School Bus / 1853 DFC3	680242	Front	89422	Front	85308	Front
467371C91	S Series School Bus / 173 FC, 183 FC, 183RE, 193 RE					83225	Front or Rear
467371C91	S Series School Bus / 183 RE with Axle Codes 14043, 14147 & 14186					83225	Front or Rear
467371C91	S Series School Bus / 193 RE - Exc. Axle Codes 14039 & 14189					83225	Front or Rear
467371C91	S Series School Bus / 1853 FC & 1853 DFC					83225	Front or Rear
467371C91	S Series School Bus / 1853 FC & 1853 DFC					83225	Front or Rear
467371C91	S Series School Bus / 1853 FC & 1853 DFC with Axle Codes 14039, 14139, 14149 & 14189 - Exc. 14149 with FD Serial Numbers					83225	Front or Rear
467372C91	S Series School Bus / 173 FC & 183 FC with Axle Codes 14149 & 14189					83225	Rear
467983C91	S Series School Bus / 1603	665932	Front or Rear	89413	Front or Rear	85012	Front or Rear
467983C91	S Series School Bus / 1603, 1703, 1803 & 1853	665932	Front or Rear	89413	Front or Rear	85012	Front or Rear
467983C91	S Series School Bus / 1603, 1703, 1803 & 1853 with 9000, 10800 or 12000 lb Front Axle	665932	Front or Rear	89413	Front or Rear	85012	Front or Rear

Legend:
 1: shock suits Front or Rear application as seen on vehicle
 2: further shock information unavailable at the time of print

PACCAR Parts recommends Fleetline™ shocks for budget conscious customers. For customers operating on washboard roads or who want maximum ride-control, an upgrade to TRP® GS shocks is recommended. Customers who want the highest-quality ride and the longest-lasting shock absorber should order the PACCAR® OE Plus shock.

OEM Part Number	Description	PACCAR OE Plus	Position	TRP® Gas	Position	Fleetline	Position
467984C91	S Series School Bus / 1603, 1703, 1803 & 1853 with Axle Codes 02089, 02091					83216	Front
467985C91	S Series School Bus / 1603, 1703, 1803 & 1853 - Exc. Axle Codes 02054, 02057, 02059, 02089, 02091, 02098, 02101, 02109, 02139, 02208, 02218, 02228, 02309, 02329, 02339	665932	Front	89413	Front	85012	Front
471201C91	S Series School Bus / 1603	665932	Front	89413	Front	85012	Front
471203C91	S Series School Bus / 1603, 1703, 1803 & 1853					83308	Rear
472367C91	S Series School Bus / 1723 S Series with 5000, 6000 or 7500 lb Front Axle					83318	Front
472411C91	S Series School Bus / 1823, 1853 S Series with 9000, 10800 or 12000 lb Front Axle			89447	Front	83456	Front
472412C91	S Series School Bus / 1823, 1853 S Series with 9000, 10800 or 12000 lb Front Axle			89447	Front	83456	Front
474002C91	S Series School Bus / 1603, 1703, 1803 & 1853					83308	Rear
501553C91	S Series School Bus / 1723, 1823, 1853 Series with International Air Suspension	680281	Rear	89411	Rear	85003	Rear
501906C91	S Series School Bus / 1823 S Series - Exc. with Rear Axle Codes 14029, 14030, 14187					83317	Rear
537524C91	S Series School Bus / 1723, 1823, 1853 Series with Neway ARD-234 Air Suspension	665783	Rear	89405	Rear	83123	Rear
586724C91	S Series School Bus / 1823, 1853 S Series with 9000, 10800 or 12000 lb Front Axle			89447	Front	83456	Front
873622C91	S Series School Bus / 1603, 1703, 1803 & 1853					83308	Rear
874695R91	S Series School Bus / 1603, 1703, 1803 & 1853 - Exc. Axle Codes 02054, 02057, 02059, 02089, 02091, 02098, 02101, 02109, 02139, 02208, 02218, 02228, 02309, 02329, 02339	665932	Front	89413	Front	85012	Front

SERIES 3000 - SCHOOL BUS CHASSIS

1675455C1	Series 3000 - School Bus Chassis / 3700, 3800 Series with International Air Suspension	680281	Rear	89411	Rear	85003	Rear
1677707C1	Series 3000 - School Bus Chassis / 3900FC Series			89440	Front	85030	Front
1690035C1	Series 3000 - School Bus Chassis / 3700, 3800 Series with International Air Suspension	680281	Rear	89411	Rear	85003	Rear
2015557C1	Series 3000 - School Bus Chassis / 3900FC Series			89440	Front	85030	Front
2018987C1	Series 3000 - School Bus Chassis / 3700, 3800 Series with International Air Suspension	680281	Rear	89411	Rear	85003	Rear
2039549C1	Series 3000 - School Bus Chassis / 3900FC Series (Genesis - Rear Engine)					85333	Front
2200327C1	Series 3000 - School Bus Chassis / 3900FC Series (Genesis - Front Engine)					85332	Front
467371C91	Series 3000 - School Bus Chassis / 3900FC Series					83225	Front or Rear

Legend:
 1: shock suits Front or Rear application as seen on vehicle
 2: further shock information unavailable at the time of print

PACCAR Parts recommends Fleetline™ shocks for budget conscious customers. For customers operating on washboard roads or who want maximum ride-control, an upgrade to TRP® GS shocks is recommended. Customers who want the highest-quality ride and the longest-lasting shock absorber should order the PACCAR® OE Plus shock.

OEM Part Number	Description	PACCAR OE Plus	Position	TRP® Gas	Position	Fleetline	Position
472412C91	Series 3000 - School Bus Chassis / 3700, 3800 Series			89447	Front	83456	Front
501553C91	Series 3000 - School Bus Chassis / 3700, 3800 Series with International Air Suspension	680281	Rear	89411	Rear	85003	Rear
501905C91	Series 3000 - School Bus Chassis / 3700, 3800 Series					83301	Rear
501906C91	Series 3000 - School Bus Chassis / 3700, 3800 Series					83317	Rear
501906C92	2006 - 10 - Series 3000 - School Bus Chassis / CE Model School Buses with OEM Number					83317	Rear
537524C91	Series 3000 - School Bus Chassis / 3700, 3800 Series with Neway ARD-234 Air Suspension	665783	Rear	89405	Rear	83123	Rear
537525C91	Series 3000 - School Bus Chassis / 3700, 3800 Series with Neway ARD-234 Air Suspension	665783	Rear	89405	Rear	83123	Rear
548532C1	Series 3000 - School Bus Chassis / 3700, 3800 Series with MOR-RYDE Rear Suspension					83103	Rear
586724C91	Series 3000 - School Bus Chassis / 3700, 3800 Series			89447	Front	83456	Front
OE 13424S	2006 - 10 - Series 3000 - School Bus Chassis / CE Model School Buses with OEM Number					83317	Rear

M.A.N. Bus

Table 6-22: M.A.N. Bus Shocks

OEM Part Number	Description	PACCAR OE Plus	Position	TRP® Gas	Position	Fleetline	Position
25-1700-106-654	Americana Bus with OEM Numbers					85708	Rear
81-43701-6543	Americana Bus with OEM Numbers					85708	Rear
81-43701-6572	Americana Bus with OEM Numbers					85708	Front
81-43701-6573	Americana Bus with OEM Numbers					85722	Front
81-43701-6537	Articulating Bus - Drive Axle					85709	Rear
81-43701-6538	Articulating Bus - Front Axle					85708	Front
81-43701-6539	Articulating Bus - Trailing Axle					85708	Rear
134	Models with OEM Number					85709	Rear
81-43701-6609	Models with OEM Number					85709	Rear
9020M-1042	Models with OEM Number					85709	Rear

Legend:
 1: shock suits Front or Rear application as seen on vehicle
 2: further shock information unavailable at the time of print

PACCAR Parts recommends Fleetline™ shocks for budget conscious customers. For customers operating on washboard roads or who want maximum ride-control, an upgrade to TRP® GS shocks is recommended. Customers who want the highest-quality ride and the longest-lasting shock absorber should order the PACCAR® OE Plus shock.

MAECO

Table 6-23: MAECO Shocks

OEM Part Number	Description	PACCAR OE Plus	Position	TRP® Gas	Position	Fleetline	Position
1668722	Models with OEM Number			89440	1	85030	1

MATSON SCHOOL BUS

Table 6-24: Matson School Bus Shocks

OEM Part Number	Description	PACCAR OE Plus	Position	TRP® Gas	Position	Fleetline	Position
5392387	Models with OEM Number	680237	Front	89422	Front	85303	Front

MCI (MOTOR COACH INDUSTRIES)

Table 6-25: MCI (Motor Coach Industries) Shocks

OEM Part Number	Description	PACCAR OE Plus	Position	TRP® Gas	Position	Fleetline	Position
12J-5-10	DL3 Bus -Drive Axle					85733	Rear
12L-5-100	DL3 Bus -Tag Axle					85727	Rear
12L-5-114	DL3 Bus -Tag Axle					85727	Rear
12L-5-88	DL3 Bus					85729	Rear
12L-5-89	DL3 Bus					85729	Rear
12L-5-96	DL3 Bus					85728	Front
12L-5-97	DL3 Bus					85728	Front
12L-5-99	Low Floor Buses with OEM Number					85339	Rear
74410	RTS Bus with Normal Front					85701	Front
695117	RTS Bus with Normal Front					85701	Front
22024673	RTS Bus with Solid Front Axle					85710	Front
G1011822	RTS Bus with Regular Rear					85702	Rear

Legend:
 1: shock suits Front or Rear application as seen on vehicle
 2: further shock information unavailable at the time of print

PACCAR Parts recommends Fleetline™ shocks for budget conscious customers. For customers operating on washboard roads or who want maximum ride-control, an upgrade to TRP® GS shocks is recommended. Customers who want the highest-quality ride and the longest-lasting shock absorber should order the PACCAR® OE Plus shock.

NEOPLAN Bus

Table 6-26: NEOPLAN Bus Shocks

OEM Part Number	Description	PACCAR OE Plus	Position	TRP® Gas	Position	Fleetline	Position
24-1700-106-149	Mini-Bus					83216	Rear
24-1700-999-362	Mini-Bus					85009	Front
BN1002002	Mini-Bus					85009	Front
BT1002011	Mini-Bus					83216	Rear
25-1700-101-426	Model 40			89447	Front or Rear	85705	Front or Rear
CL1002003	Model 80B			89447	Front or Rear	85705	Front or Rear
DT1002002	Model 40					85707	Front or Rear
DZ1002002	Model 80B			89447	Front or Rear	85705	Front or Rear
680307	Models with OEM Number			89447	Front or Rear	85705	Front or Rear
680308	Models with OEM Number					85706	Front or Rear
AA1002002	Models with OEM Number			89447	Front or Rear	85705	Front or Rear
AA1002003	Models with OEM Number			89447	Front or Rear	85705	Front or Rear
AA1802002	Models with OEM Number			89447	Front or Rear	85705	Front or Rear
AC1002002	Models with OEM Number			89447	Front or Rear	85705	Front or Rear
AC1002003	Models with OEM Number			89447	Front or Rear	85705	Front or Rear
DT1802002	Models with OEM Number			89447	Front or Rear	85705	Front or Rear
GJ1002002	Models with OEM Number					85706	Front or Rear
GJ1002003	Models with OEM Number			89447	Front or Rear	85705	Front or Rear
MM1002002	Models with OEM Number			89447	Front or Rear	85705	Front or Rear
MM1002003	Models with OEM Number			89447	Front or Rear	85705	Front or Rear
97-9999-02519	Additional OEM Interchanges					85707	1
CI 1002003	Additional OEM Interchanges			89447	1	85705	1

NOVA Bus

Table 6-27: NOVA Bus Shocks

OEM Part Number	Description	PACCAR OE Plus	Position	TRP® Gas	Position	Fleetline	Position
74410	RTS Bus					85701	Front
695117	RTS Bus					85701	Front
4975515	RTS Bus					85701	Front
22012079	RTS Bus					85701	Front

Legend:
 1: shock suits Front or Rear application as seen on vehicle
 2: further shock information unavailable at the time of print

PACCAR Parts recommends Fleetline™ shocks for budget conscious customers. For customers operating on washboard roads or who want maximum ride-control, an upgrade to TRP® GS shocks is recommended. Customers who want the highest-quality ride and the longest-lasting shock absorber should order the PACCAR® OE Plus shock.

OEM Part Number	Description	PACCAR OE Plus	Position	TRP® Gas	Position	Fleetline	Position
22024673	RTS Bus with Solid Front Axle					85710	Front
22045526	RTS Bus					85702	Rear
22052014	RTS Bus					85702	Rear
G1011822	RTS Bus					85702	Rear
G1011823	RTS Bus with "V" Drive					85710	Front
G1101590	RTS Bus with "V" Drive					85713	Rear
G1203223	RTS Bus					85702	Rear
OE 10086S	RTS Bus					85702	Rear
97-2201-00151	Classic Bus with OEM Number					85700	Front or Rear
680480	LoFloor Models with OEM Numbers					85377	Front
481700131250	LoFloor Models with OEM Numbers					85377	Front
481700131252	LoFloor Models with OEM Numbers					85378	Rear
N16248	LoFloor Models with OEM Numbers					85377	Front
N16249	LoFloor Models with OEM Numbers					85378	Rear
N21543	LoFloor Models with OEM Numbers					85378	Rear
N31830	LoFloor Models with OEM Numbers					85378	Rear
N31831	LoFloor Models with OEM Numbers					85377	Front
680231	Models with OEM Numbers					85313	Rear
680232	Models with OEM Numbers					85733	Rear
680323	Models with OEM Numbers					85700	Front
680323	Models with OEM Numbers					85700	1
680326	Models with OEM Numbers					85700	Front
680470	Models with OEM Numbers					85713	Rear
680481	Models with OEM Numbers					85378	Rear
12J-5-10	Models with OEM Numbers					85733	Rear
12J-5-11	Models with OEM Numbers					85313	Rear
G1201338	Models with OEM Number					85710	Front
G1201339	Models with OEM Number					85702	Rear
G5008070	Models with OEM Numbers					85700	Front
N22212	Models with OEM Numbers					85700	Front
97-9999-02514	Additional OEM Interchanges					85700	1

Legend:
 1: shock suits Front or Rear application as seen on vehicle
 2: further shock information unavailable at the time of print

PACCAR Parts recommends Fleetline™ shocks for budget conscious customers. For customers operating on washboard roads or who want maximum ride-control, an upgrade to TRP® GS shocks is recommended. Customers who want the highest-quality ride and the longest-lasting shock absorber should order the PACCAR® OE Plus shock.

OPTIMA BUS CORPORATION

Table 6-28: Optima Bus Corporation Shocks

OEM Part Number	Description	PACCAR OE Plus	Position	TRP® Gas	Position	Fleetline	Position
1260008	Buses with Ridewell RAS - 227 Series Steer Axles Air Suspension with OEM Number					87017	Rear
90-2610-SP1	Buses with Ridewell RAS - 227 Series Steer Axle Air Suspension with OEM Number					87017	Rear

ORION BUS INDUSTRIES

Table 6-29: Orion Bus Industries Shocks

OEM Part Number	Description	PACCAR OE Plus	Position	TRP® Gas	Position	Fleetline	Position
010134509	Orion I					85717	Front
010234506	Orion I					85714	Rear
010134505-4	Orion I					85715	Front
010234503-4	Orion I	680242	Rear	89422	Rear	85308	Rear
20117501	Orion II					85720	Front
20117503	Orion II					85720	Front
020117504	Orion II					85720	Front
20117505	Orion II					85720	Front
020273541	Orion II			89436	Front	83203	Front
020273544	Orion II			89436	Front	83203	Front
020273546	Orion II					85719	Rear
020273547	Orion II					85719	Rear
020273548	Orion II					85719	Rear
020273549	Orion II					85719	1
010134505-4	Orion II					85715	Front
010234503-4	Orion II	680242	Rear	89422	Rear	85308	Rear
050134510	Orion V					85732	Front
050134513	Orion V					85732	Front
050231505	Orion V					85716	Rear
010134508-4	Orion V					85718	Front

Legend:
 1: shock suits Front or Rear application as seen on vehicle
 2: further shock information unavailable at the time of print

PACCAR Parts recommends Fleetline™ shocks for budget conscious customers. For customers operating on washboard roads or who want maximum ride-control, an upgrade to TRP® GS shocks is recommended. Customers who want the highest-quality ride and the longest-lasting shock absorber should order the PACCAR® OE Plus shock.

OEM Part Number	Description	PACCAR OE Plus	Position	TRP® Gas	Position	Fleetline	Position
050134502-4	Orion V					85718	Front
050134506-4	Orion V					85718	Front
060231508	Orion VI (Low Floor)					85717	Front
070131502	Orion VII with OEM Number					87016	Front
070131506	Orion VII with OEM Number					87016	Front
070231514	Orion VII with OEM Number					85729	Rear
070231527	Orion VII - 30-foot Rear					85729	Rear
050230501	Orion 102					85716	Rear
050231505	Orion 102					85716	Rear
050134501-4	Orion 102					85716	Front
680271	Models with OEM Number					85714	Rear
680328	Models with OEM Number					85717	Front
680378	Models with OEM Number					85720	Front
695327	Models with OEM Number					85732	Front
695343	Models with OEM Number					85732	Front
695366	Models with OEM Number					85732	Front
695389	Models with OEM Number					87016	Front
695420	Models with OEM Number					85729	Rear
695421	Models with OEM Number					87016	Front
695440	Models with OEM Number					85729	Rear
665596	Additional OEM Interchanges					85719	1
680091	Additional OEM Interchanges	680237	1	89422	1	85303	1
680274	Additional OEM Interchanges					85716	1
680352	Additional OEM Interchanges					85711	1
020273549	Additional OEM Interchanges					85719	1
050134508	Additional OEM Interchanges					85718	1
050231507	Additional OEM Interchanges					85716	1
010134501-4	Additional OEM Interchanges					85307	1
010134504-4	Additional OEM Interchanges					85715	1
010134506-4	Additional OEM Interchanges					85717	1
020273541-4	Additional OEM Interchanges			89436	1	85000	1
020273547-4	Additional OEM Interchanges					85719	1
0501345-11	Additional OEM Interchanges					85718	1
050231502-4	Additional OEM Interchanges					85716	1
97-9999-02635	Additional OEM Interchanges					85718	1
97-9999-02636	Additional OEM Interchanges					85716	1
A-4890	Additional OEM Interchanges					85712	1
OB3166657	Additional OEM Interchanges					85700	1

Legend:
 1: shock suits Front or Rear application as seen on vehicle
 2: further shock information unavailable at the time of print

PACCAR Parts recommends Fleetline™ shocks for budget conscious customers. For customers operating on washboard roads or who want maximum ride-control, an upgrade to TRP® GS shocks is recommended. Customers who want the highest-quality ride and the longest-lasting shock absorber should order the PACCAR® OE Plus shock.

PREVOST

Table 6-30: Prevost Shocks

OEM Part Number	Description	PACCAR OE Plus	Position	TRP® Gas	Position	Fleetline	Position
630127	1996 - 03 - / H3 Bus, H3 VIP Bus Drive and Tag Axle Shocks					85736	Rear
630127	1999 - 03 - / XL II Bus, XL II MTH Bus Drive and Tag Axle Shocks					85736	Rear
630134	1996 - 03 - / H3 Bus, H3 VIP Bus With I-Beam Front Suspension					85329	Front
630134	1999 - 03 - / XL II Bus, XL II MTH Bus With I-Beam Front Suspension					85329	Front
630136	2007 - 09 - / XL II MTH Bus Front Suspension					85330	Front
630163	1999 - 03 - / XL II Bus, XL II MTH Bus With Independant Front Suspension					85330	Front
630252	2004 - 06 - / XL II Bus, XL II MTH Bus With I-Beam Front Suspension					85329	Front
630252	2004 - 09 - / H3 Bus, H3 VIP Bus With I-Beam Front Suspension					85329	Front
630253	2004 - 06 - / XL II Bus, XL II MTH Bus Drive and Tag Axle Shocks					85713	Rear
630253	2004 - 09 - / H3 Bus, H3 VIP Bus Drive and Tag Axle Shocks					85713	Rear
630253	2007 - 09 - / XL II MTH Bus Drive and Tag Axle Shocks					85713	Rear
650407	1996 - 03 - / H3 Bus, H3 VIP Bus Drive and Tag Axle Shocks					85736	Rear
650407	1999 - 03 - / XL II Bus, XL II MTH Bus Drive and Tag Axle Shocks					85736	Rear
680422	1996 - 03 - / H3 Bus, H3 VIP Bus With I-Beam Front Suspension					85329	Front
680422	1999 - 03 - / XL II Bus, XL II MTH Bus With I-Beam Front Suspension					85329	Front
630136	X3-45 Bus With Independant Front Suspension					85330	Front
630253	X3-45 Bus Drive and Tag Axle Shocks					85713	Rear

Legend:
 1: shock suits Front or Rear application as seen on vehicle
 2: further shock information unavailable at the time of print

PACCAR Parts recommends Fleetline™ shocks for budget conscious customers. For customers operating on washboard roads or who want maximum ride-control, an upgrade to TRP® GS shocks is recommended. Customers who want the highest-quality ride and the longest-lasting shock absorber should order the PACCAR® OE Plus shock.

RIDEWELL CORPORATION

Table 6-31: Ridewell Corporation Shocks

OEM Part Number	Description	PACCAR OE Plus	Position	TRP® Gas	Position	Fleetline	Position
1260008	Bus and R.V. Air-Rides / RAS - 227 Series Steer Axles Air Suspension with OEM Number					87017	Rear
90-2610-SP1	Bus and R.V. Air-Rides / RAS - 227 Series Steer Axle Air Suspension with OEM Number					87017	Rear
AS563B	Bus and R.V. Air-Rides / Mobile Home & RV with Air Suspension			89436	Rear	83203	Rear
S6009B	Bus and R.V. Air-Rides / Mobile Home & RV with Air Suspension			89436	Rear	83203	Rear

SAF HOLLAND

Table 6-32: SAF Holland Shocks

OEM Part Number	Description	PACCAR OE Plus	Position	TRP® Gas	Position	Fleetline	Position
665002	Truck, Bus & Motorhome Air Suspensions / Models with OEM Number					85004	Rear
665003	Truck, Bus & Motorhome Air Suspensions / Models with OEM Number			89419	Rear	85300	Rear
671921	Truck, Bus & Motorhome Air Suspensions / Models with OEM Number					85916	Rear
671922	Truck, Bus & Motorhome Air Suspensions / Models with OEM Number			89405	Rear		
671923	Truck, Bus & Motorhome Air Suspensions / Models with OEM Number			89440	Rear		
680645	Truck, Bus & Motorhome Air Suspensions / Models with OEM Number					85321	Rear
90044008	Truck, Bus & Motorhome Air Suspensions / ART-500 Series Truck & Tractor Tag Axle Air Suspension (ART-500-US, ART-500-US-A)			89436	Rear	85000	Rear
90044011	Truck, Bus & Motorhome Air Suspensions / ARD-125 Series Truck & Tractor Air Suspension (ARD-125-8 use on Freightliner, White, Western Star)					85004	Rear
90044011	Truck, Bus & Motorhome Air Suspensions / ARD-165 Series Truck & Tractor Air Suspension (ARD-165-A, ARD-165-B)					85004	Rear

Legend:
 1: shock suits Front or Rear application as seen on vehicle
 2: further shock information unavailable at the time of print

PACCAR Parts recommends Fleetline™ shocks for budget conscious customers. For customers operating on washboard roads or who want maximum ride-control, an upgrade to TRP® GS shocks is recommended. Customers who want the highest-quality ride and the longest-lasting shock absorber should order the PACCAR® OE Plus shock.

OEM Part Number	Description	PACCAR OE Plus	Position	TRP® Gas	Position	Fleetline	Position
90044011	Truck, Bus & Motorhome Air Suspensions / ARD-244 Series Truck & Tractor Air Suspension (ARD-244-8 use on Freightliner, White, Western Star)					85004	Rear
90044012	Truck, Bus & Motorhome Air Suspensions / ART-550 Series Truck & Tractor Tag Axle Air Suspension (ART-550-US-1, -2, -3)					85006	Rear
90044016	Truck, Bus & Motorhome Air Suspensions / ARD-125 Series Truck & Tractor Air Suspension (ARD-125-8 use on Mack)			89419	Rear	85300	Rear
90044016	Truck, Bus & Motorhome Air Suspensions / ARD-190 Series Truck & Tractor Air Suspension (ARD-190-B)			89419	Rear	85300	Rear
90044016	Truck, Bus & Motorhome Air Suspensions / ARD-244 Series Truck & Tractor Air Suspension (ARD-244-8 use on Mack)			89419	Rear	85300	Rear
90044017	Truck, Bus & Motorhome Air Suspensions / ART-551 Series Truck & Tractor Tag Axle Air Suspension (ART-551-B-2, -3, ART-551-US-1, -2, -3)					83204	Rear
90044025	Truck, Bus & Motorhome Air Suspensions / ARD-120 Series Truck & Tractor Air Suspension (ARD-120-6)	680279	Rear	89414	Rear	83209	Rear
90044025	Truck, Bus & Motorhome Air Suspensions / ARD-125 Series Truck & Tractor Air Suspension (ARD-125-6 use on Ford, GM, International/ IC Bus, Mack, White, Western Star, Freightliner)	680279	Rear	89414	Rear	83209	Rear
90044025	Truck, Bus & Motorhome Air Suspensions / ARD-238 Series Truck & Tractor Air Suspension (ARD-238-6)	680279	Rear	89414	Rear	83209	Rear
90044025	Truck, Bus & Motorhome Air Suspensions / ARD-244 Series Truck & Tractor Air Suspension (ARD-244-6 use on Ford, GM, International/ IC Bus, Mack, White, Western Star, Freightliner)	680279	Rear	89414	Rear	83209	Rear
90044025	Truck, Bus & Motorhome Air Suspensions / ARDST-123 Series Truck & Tractor Air Suspension (ARDST-123-6, ARDSTML-123-6)	680279	Rear	89414	Rear	83209	Rear
90044025	Truck, Bus & Motorhome Air Suspensions / ARDST-244 Series Truck & Tractor Air Suspension (ARDST-244-6)	680279	Rear	89414	Rear	83209	Rear
90044025	Truck, Bus & Motorhome Air Suspensions / ARDST-246 Series Truck & Tractor Air Suspension (ARDST-246-6, ARDSTML-246-6)	680279	Rear	89414	Rear	83209	Rear
90044025	Truck, Bus & Motorhome Air Suspensions / ARDST-250-6 Series Truck & Tractor Air Suspension	680279	Rear	89414	Rear	83209	Rear

Legend:
1: shock suits Front or Rear application as seen on vehicle
2: further shock information unavailable at the time of print

PACCAR Parts recommends Fleetline™ shocks for budget conscious customers. For customers operating on washboard roads or who want maximum ride-control, an upgrade to TRP® GS shocks is recommended. Customers who want the highest-quality ride and the longest-lasting shock absorber should order the PACCAR® OE Plus shock.

OEM Part Number	Description	PACCAR OE Plus	Position	TRP® Gas	Position	Fleetline	Position
90044046	Truck, Bus & Motorhome Air Suspensions / ARD-234 Series Truck & Tractor Air Suspension (ARD-234-6)	665783	Rear	89405	Rear	83123	Rear
90044162	Truck, Bus & Motorhome Air Suspensions / ART-500 Series Truck & Tractor Tag Axle Air Suspension (ART-500-B, ART-500-B-1)					83128	Rear
90044162	Truck, Bus & Motorhome Air Suspensions / ART-505 Series Truck & Tractor Tag Axle Air Suspension (ART-505-B, -1, ART-505-C, -1)					83128	Rear
90044162	Truck, Bus & Motorhome Air Suspensions / ART-541 Series Truck & Tractor Tag Axle Air Suspension (ART-541B)					83128	Rear
90044162	Truck, Bus & Motorhome Air Suspensions / ART-551 Series Truck & Tractor Tag Axle Air Suspension (ART-551-B-1)					83128	Rear
90044162	Truck, Bus & Motorhome Air Suspensions / ART-555 Series Truck & Tractor Tag Axle Air Suspension (ART-555-B-1, ART-555-C-1)					83128	Rear
90044448	Truck, Bus & Motorhome Air Suspensions / ARDTB-125 Series Bus Air Suspension (ARDTB-125-6A)					85051	Rear
90044642	Truck, Bus & Motorhome Air Suspensions / ART-555 Series Truck & Tractor Tag Axle Air Suspension (ART-555-B-2, -3, ART555C-2, -3)					83127	Rear
90044907	Truck, Bus & Motorhome Air Suspensions / ARDAB-120 Series Truck & Tractor Air Suspension (ARDAB-120-5)					83635	Rear
90044907	Truck, Bus & Motorhome Air Suspensions / ARDAB-238-5 Series Truck & Tractor Air Suspension					83635	Rear
90044907	Truck, Bus & Motorhome Air Suspensions / ARDAB-240 Series Truck & Tractor Air Suspension (ARDAB-240-5)					83635	Rear
90045031	Truck, Bus & Motorhome Air Suspensions / ARDTB-125 Series Bus Air Suspension (ARDTB-125-6B)					85968	Rear
90045050	Truck, Bus & Motorhome Air Suspensions / ARDTB-125-6A (Note: Front shock)					85914	Front
90045050	Truck, Bus & Motorhome Air Suspensions / ARDTB-125-6A (Note: Front shock)					85914	Rear
90045053	Truck, Bus & Motorhome Air Suspensions / ARDTB-125-6A (Note: Rear shock)					85908	Rear
90045068	Truck, Bus & Motorhome Air Suspensions / AD-123 Series Truck and Tractor Air Suspension (AD123-6,-8,-10,-8.75)			89441	Rear		

Legend:
1: shock suits Front or Rear application as seen on vehicle
2: further shock information unavailable at the time of print

PACCAR Parts recommends Fleetline™ shocks for budget conscious customers. For customers operating on washboard roads or who want maximum ride-control, an upgrade to TRP® GS shocks is recommended. Customers who want the highest-quality ride and the longest-lasting shock absorber should order the PACCAR® OE Plus shock.

OEM Part Number	Description	PACCAR OE Plus	Position	TRP® Gas	Position	Fleetline	Position
90045075	Truck, Bus & Motorhome Air Suspensions / AD-150 Series Truck & Tractor Air Suspension					85911	Rear
90045084	Truck, Bus & Motorhome Air Suspensions / Models with OEM Number					85968	Rear
90045099	Truck, Bus & Motorhome Air Suspensions / AD-123 Series Truck and Tractor Air Suspension (AD123-6,-8,-10,-8.75) Shock Mount flush with bottom of frame					85906	Rear
90045099	Truck, Bus & Motorhome Air Suspensions / AD-246 Series Truck & Tractor Air Suspension (AD246 -6, -8, -10, -8.75)					85906	Rear
90045132	Truck, Bus & Motorhome Air Suspensions / AD-123 Series Truck and Tractor Air Suspension (AD123-6,-8,-10,-8.75) Shock Mount approx. 2-1/2" above bottom of frame					85909	Rear
90045132	Truck, Bus & Motorhome Air Suspensions / AD-246 Series Truck & Tractor Air Suspension (AD246 -6, -8, -10, -8.75)					85909	Rear
90045132	Truck, Bus & Motorhome Air Suspensions / AD-252-10 Tandem Axle					85909	Rear
90045138	Truck, Bus & Motorhome Air Suspensions / AD-200 Series Truck & Tractor Air Suspension (AD-200-7, -8, -9, -11)					85910	Rear
90045336	Truck, Bus & Motorhome Air Suspensions / Models with OEM Number					85014	Rear
90045418	Truck, Bus & Motorhome Air Suspensions / Models with OEM Number					85916	Rear
90045419	Truck, Bus & Motorhome Air Suspensions / Models with OEM Number			89405	Rear		
90045420	Truck, Bus & Motorhome Air Suspensions / Models with OEM Number			89440	Rear		
90045432	Truck, Bus & Motorhome Air Suspensions / AD-130 Series Truck and Tractor Air Suspension with OEM Number					85321	Rear
90045455	Truck, Bus & Motorhome Air Suspensions / Models with OEM Number					85909	Rear
90045466	Truck, Bus & Motorhome Air Suspensions / AD-130 Series Truck and Tractor Air Suspension (AD123-6,-8,-10,-8.75)			89406	Rear		
90045504	Truck, Bus & Motorhome Air Suspensions / Models with OEM Number					85030	Rear
90045568	Truck, Bus & Motorhome Air Suspensions / Models with OEM Number					85060	Rear

Legend:

- 1: shock suits Front or Rear application as seen on vehicle
 2: further shock information unavailable at the time of print

PACCAR Parts recommends Fleetline™ shocks for budget conscious customers. For customers operating on washboard roads or who want maximum ride-control, an upgrade to TRP® GS shocks is recommended. Customers who want the highest-quality ride and the longest-lasting shock absorber should order the PACCAR® OE Plus shock.

THOMAS BUILT

Table 6-33: Thomas Built School Bus Shocks

OEM Part Number	Description	PACCAR OE Plus	Position	TRP® Gas	Position	Fleetline	Position
61300285	ROC Front, SAF-T-Liner					83102	Front
61310101	Model MVP					85736	Front or Rear
61310232	Models with Neway Tandem Air Suspension			89436	Rear	85000	Rear
61310434	Models with FAS II Rear Air Suspension			89443	Rear	85724	Rear
61310478	Models with FAS II Rear Air Suspension			89443	Rear	85724	Rear
10-13634-000	Buses with 12000 lb Taper-leaf Front Suspension			89449	Front	85918	Front
16-18708-000	Models with FAS II Rear Air Suspension			89443	Rear	85724	Rear
60998-001	SAF-T-Liner HDX Models with Hendrickson Comfort Air Rear Air Suspension					85337	Rear
614974	School Bus					85304	Front
680010	School Bus					85304	Front
680054	School Bus					85307	Rear
300-0614966	School Bus					85307	Front or Rear
128745	Models with OEM Number					83102	Front
651442	Models with OEM Number					83102	Front
659287	Models with OEM Number					83102	Front
61300112	Models with OEM Number					83613	Front
61300224	Models with OEM Number			89449	Front	85918	Front
61300240	Models with OEM Number			89449	Front	85918	Front
61310102	Models with OEM Number	680242	Rear	89422	Rear	85308	Rear
61310103	Models with OEM Number	680242	Rear	89422	Rear	85308	Rear
16-19138-000	Models with OEM Number			89431	Front	85058	Front
680-323-0300	Models with OEM Number					85006	Front
680-326-0000	Models with OEM Number					83120	Rear
GBL654725	Models with OEM Number					83120	Rear
GBL665538	Models with OEM Number					85006	Front
87002	Additional OEM Interchanges					85736	1
680088	Additional OEM Interchanges					85713	1
728802	Additional OEM Interchanges					85736	1
6130029	Additional OEM Interchanges					85712	1
61310104	Additional OEM Interchanges					85713	1

Legend:

- 1: shock suits Front or Rear application as seen on vehicle
 2: further shock information unavailable at the time of print

PACCAR Parts recommends Fleetline™ shocks for budget conscious customers. For customers operating on washboard roads or who want maximum ride-control, an upgrade to TRP® GS shocks is recommended. Customers who want the highest-quality ride and the longest-lasting shock absorber should order the PACCAR® OE Plus shock.

OEM Part Number	Description	PACCAR OE Plus	Position	TRP® Gas	Position	Fleetline	Position
6130-0114	Additional OEM Interchanges			89437	1		
63-0001	Additional OEM Interchanges					85713	1
A-4890	Additional OEM Interchanges					85712	1

TMC (TRANSPORTATION MANUFACTURING CORPORATION)

Table 6-34: TMC (Transportation Manufacturing Corporation) Shocks

OEM Part Number	Description	PACCAR OE Plus	Position	TRP® Gas	Position	Fleetline	Position
74410	RTS Bus with Normal Front					85701	Front
680350	RTS Bus with Solid Front Axle					85710	Front
695117	RTS Bus with Normal Front					85701	Front
695273	RTS Bus with Solid Front Axle					85710	Front
695279	RTS Bus with Solid Front Axle					85710	Front
4975515	RTS Bus with Normal Front					85701	Front
22012079	RTS Bus with Normal Front					85701	Front
22024673	RTS Bus with Solid Front Axle					85710	Front
22045526	RTS Bus with Regular Rear					85702	Rear
22046485	RTS Bus with Solid Front Axle					85710	Front
22052014	RTS Bus with Regular Rear					85702	Rear
G1011822	RTS Bus with Regular Rear					85702	Rear
G1101590	RTS Bus with "V" Drive Rear					85713	Rear
12L-5-99	Low Floor Buses with OEM Number					85339	Rear

Legend:
 1: shock suits Front or Rear application as seen on vehicle
 2: further shock information unavailable at the time of print

PACCAR Parts recommends Fleetline™ shocks for budget conscious customers. For customers operating on washboard roads or who want maximum ride-control, an upgrade to TRP® GS shocks is recommended. Customers who want the highest-quality ride and the longest-lasting shock absorber should order the PACCAR® OE Plus shock.

VAN HOOL

Table 6-35: Van Hool Shocks

OEM Part Number	Description	PACCAR OE Plus	Position	TRP® Gas	Position	Fleetline	Position
665562	TL 13/14 Buses					85708	Front or Rear
665563	T811, T812, T813, T814 Buses					85708	Front or Rear
665563	T815 4D Buses					85708	Front or Rear
6243-13790	TL 13/14 Buses					85708	Front or Rear
6243-14040	T811, T812, T813, T814 Buses					85708	Front or Rear
6243-14040	T815 4D Buses					85708	Front or Rear

Legend:
 1: shock suits Front or Rear application as seen on vehicle
 2: further shock information unavailable at the time of print

PACCAR Parts recommends Fleetline™ shocks for budget conscious customers. For customers operating on washboard roads or who want maximum ride-control, an upgrade to TRP® GS shocks is recommended. Customers who want the highest-quality ride and the longest-lasting shock absorber should order the PACCAR® OE Plus shock.

HENDRICKSON SUSPENSIONS

SP-217 B AIRTEK® FOR INTERNATIONAL IC BUS VEHICLES

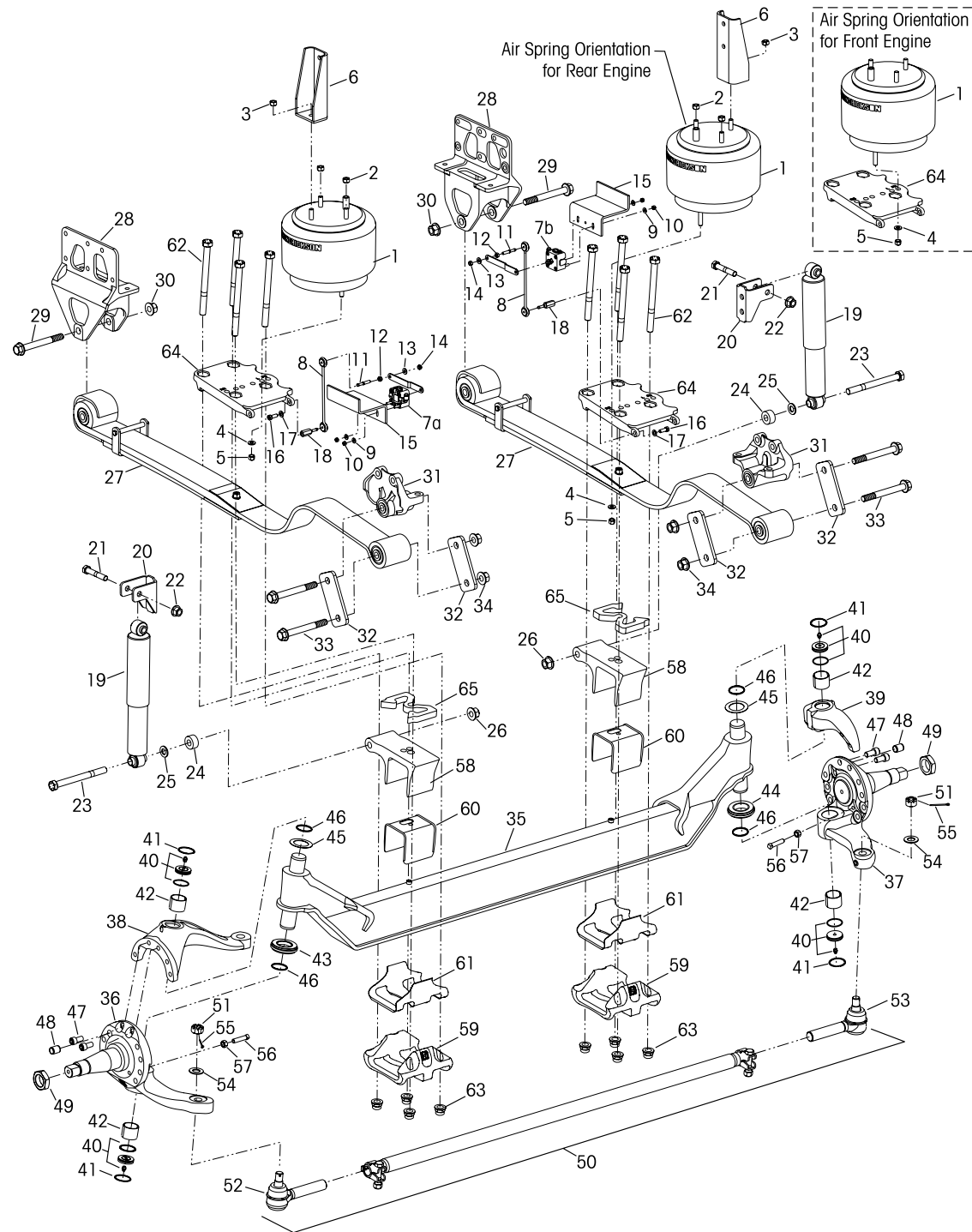


Table 6-36: SP-217 B AIRTEK® for International IC Bus Vehicles

OEM Part Number	Item No.	Description	Qty.
67568-002	1	Air Spring Assembly	2
n/a	2	**1/2"-13 UNC Upper Air Spring Locknut	4
n/a	3	**3/4"-16 UNF Upper Air Spring Locknut	2
n/a	4	**1/2" Lower Air Spring Washer	2
n/a	5	**1/2"-13 UNC Lower Air Spring Locknut	2
n/a	6	**Air Spring Bracket	2
59427-013		Height Control Valve Assembly - Left Hand, Includes Item Nos. 7a, 8-14	1
59427-014		Height Control Valve Assembly - Right Hand, Includes Item Nos. 7b-14	1
59935-011	7a	Height Control Valve - *Left Hand	1
59935-018	7b	Height Control Valve - *Right Hand	1
59428-004	8	*Height Control Valve Linkage	2
n/a	9	*1/4" Washer	4
n/a	10	*1/4" Locknut	4
n/a	11	*5/16" Stud	2
n/a	12	*5/16" Hex Nut	2
n/a	13	*5/16" Washer	2
n/a	14	*5/16" Locknut	2
n/a	15	**Height Control Valve Bracket	2
n/a	16	3/8"-16 UNC 1.0" Hex Head Bolt	2
n/a	17	3/8" Washer	2
59429-003	18	Link Mount - RE	2
64742-002	18	Link Mount - FE Right Hand	1
59429-003	18	Link Mount - FE Left Hand	1
65992-006	19	Shock Absorber, Replaces 65992-001	2
n/a	20	**Shock Absorber Bracket	2
n/a	21	**M16 x 90 Upper Shock Bolt	2
n/a	22	**M16 Upper Shock Flange Locknut	2
n/a	23	**3/4"-10 UNC 8.0" Lower Shock Bolt	2
n/a	24	**3/4" Shock Spacer	2
n/a	25	**3/4" Lower Shock Washer	2
n/a	26	**3/4"-10 UNC Lower Shock Flange Locknut	2
67420-000	27	Leaf Spring Assembly	2
n/a	28	**Front Hanger	2
n/a	29	**3/4"-16 UNF 6.5" Flange Hex Head Bolt	2
n/a	30	**3/4"-16 UNF Flange Hex Locknut	2
n/a	31	**Rear Hanger	2
n/a	32	**Shackle Bracket	4

NOTE:

* Item included in assembly only, part not sold separately.

** Not supplied by Hendrickson, used for reference only. Refer to the vehicle manufacturer for more information.
 HENDRICKSON AIRTEK RIDE HEIGHT GAUGE FOR INTERNATIONAL IC BUS VEHICLES — Literature number 45745-252, Not supplied by Hendrickson, used for reference only. Refer to the vehicle manufacturer for more information.

OEM Part Number	Item No.	Description	Qty.
n/a	33	**3/4"-16 UNF 6.5" Flange Hex Head Bolt	2
n/a	34	**3/4"-16 UNF Flange Hex Locknut	2
70952-318		STEERTEK Axle Assembly, Includes Item Nos. 32-65 - 14.6K, 200" Wheelbase	1
70952-328		STEERTEK Axle Assembly, Includes Item Nos. 32-65 - 12K, 200" Wheelbase	1
64905-005	35	Axle & Kingpin Assembly	1
58900-073	36	Lower Steering Knuckle Assembly - Left Hand	1
58900-074	37	Lower Steering Knuckle Assembly - Right Hand	1
60903-046	38	Upper Steering Knuckle Assembly - Left Hand	1
60904-034	39	Upper Steering Knuckle Assembly - Right Hand	1
60961-040		Kingpin Bushing and Bearing Service Kit, Axle Set, Includes Kit Nos. 60961-009 & 60961-039	
60961-009		Left Hand Kingpin Bushing w/Composite Thrust Bearing Service Kit, Includes Item Nos. 40-43, 45-47 & Loctite	
60961-039		Right Hand Kingpin Bushing w/Roller Thrust Bearing Service Kit, Includes Item Nos. 40-42, 44-47 & Loctite	
59156-000	40	Grease Cap Assembly	4
58937-000	41	Retaining Ring	4
58909-000	42	Kingpin Bushing	4
60961-043		Thrust Bearing Service Kit, Axle Set, Includes Kit Nos. 60961-041 & 60961-042	
60961-041		Left Hand Composite Thrust Bearing Service Kit, Includes Item Nos. 43, 45-47, Loctite	
60961-042		Right Hand Roller Thrust Bearing Service Kit, Includes Item Nos. 44-47, Loctite	
59828-000	43	Left Hand Composite Thrust Bearing	1
64256-000	44	Right Hand Roller Thrust Bearing	1
60259-002	45	Kingpin Shim - 0.047"	2
60259-001	Not Shown	Kingpin Shim - 0.005" (As needed for service)	
58910-001	46	Kingpin Seal, Replaces 58910-000	4
60236-001	47	5/8"-11 UNC Socket Head Cap Screw	4
60937-000	Not Shown	Loctite (Red) Compound Tube	1
64246-000	48	ABS Sensor Sleeve	2
64578-000	49	11/2"-12 UNF Spindle Nut	2
64006-002	50	Tie Rod Assembly, Includes Item No. 51	1
n/a	51	*7/8" Castle Nut	2
60961-010		Tie Rod End Service Kit, Axle Set, Includes Kit Nos. 60961-025, 60961-026	
60961-025		Left Hand Tie Rod End Service Kit, Includes Item Nos. 52, 54-55	
60961-026		Right Hand Tie Rod End Service Kit, Includes Item Nos. 53-55	
64002-001	52	Left Hand Tie Rod End	1
64002-002	53	Right Hand Tie Rod End	1
22962-007	54	7/8" Flat Washer	2
17800-004	55	Tie Rod Nut Cotter Pin	2

NOTE:
 * Item included in assembly only, part not sold separately.
 ** Not supplied by Hendrickson, used for reference only. Refer to the vehicle manufacturer for more information.
 HENDRICKSON AIRTEK RIDE HEIGHT GAUGE FOR INTERNATIONAL IC BUS VEHICLES — Literature number 45745-252, Not supplied by Hendrickson, used for reference only. Refer to the vehicle manufacturer for more information.

OEM Part Number	Item No.	Description	Qty.
60961-069		Stop Bolt Service Kit, One Side, Includes Item Nos. 56-57	
60238-001	56	1/2"-13 UNC Square Head Bolt	2
60240-000	57	1/2"-13 UNC Hex Jam Nut	2
59952-030	58	Top Axle Wrap	2
64722-003	59	Bottom Axle Wrap	2
60961-015		Top/Bottom Axle Wrap Liner Service Kit, One Side, Includes Item Nos. 60-61	
60508-000	60	Top Axle Wrap Liner	2
59845-000	61	Bottom Axle Wrap Liner	2
n/a	62	**3/4"-16 UNF 9.0" Hex bolt	8
n/a	63	**3/4"-16 UNF Flange Locknut	8
67719-000	64	Top Pad	2
64536-020	65	Z Spacer - 20 mm	2

NOTE:
 * Item included in assembly only, part not sold separately.
 ** Not supplied by Hendrickson, used for reference only. Refer to the vehicle manufacturer for more information.
 HENDRICKSON AIRTEK RIDE HEIGHT GAUGE FOR INTERNATIONAL IC BUS VEHICLES — Literature number 45745-252, Not supplied by Hendrickson, used for reference only. Refer to the vehicle manufacturer for more information.

**SP-172C SOFTEK® - BLUE BIRD ALL AMERICAN BUSES
- 13.2K/14.6K CAPACITY, LH DRIVE STEERTEK AXLE**

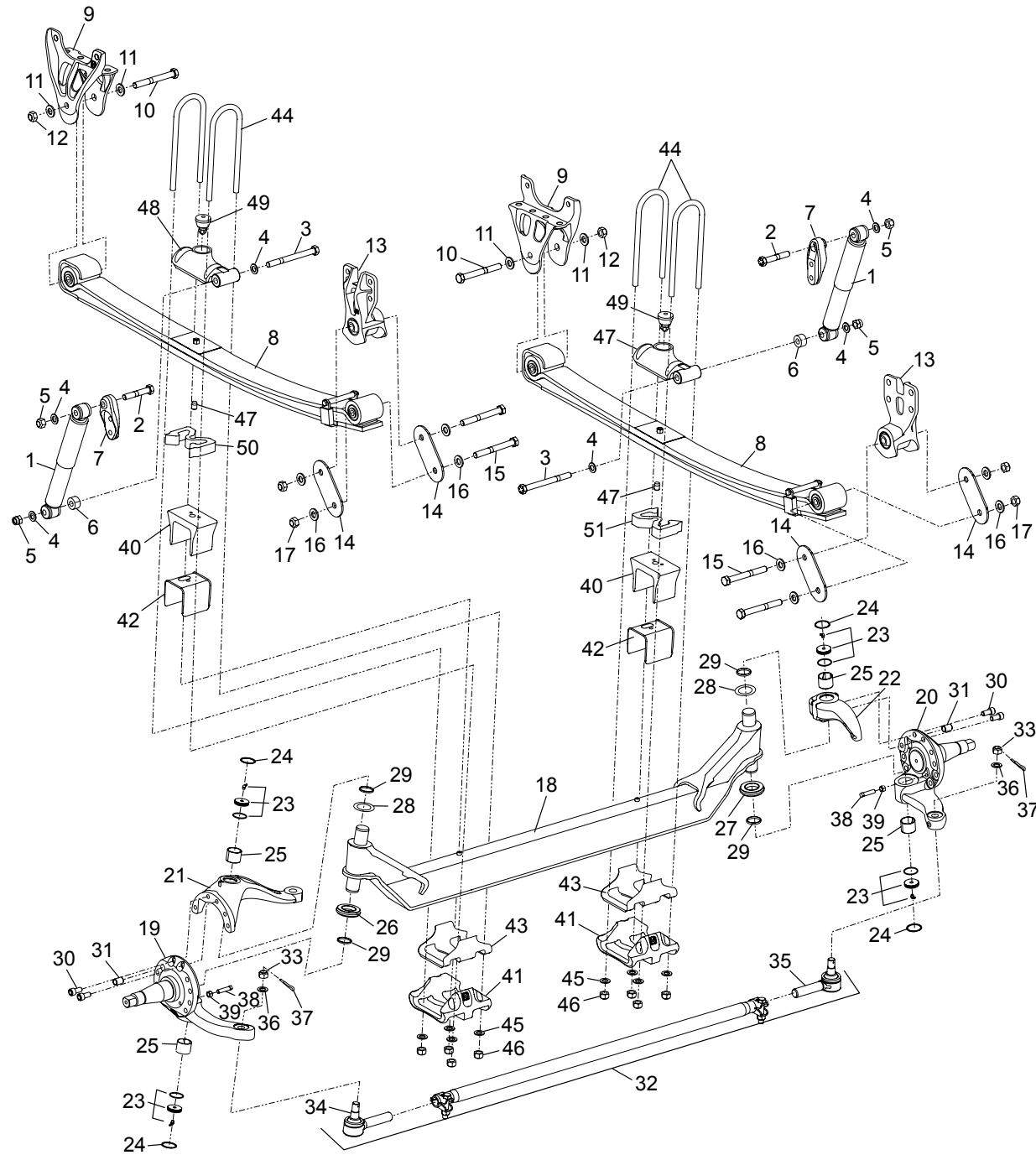


Table 6-37: SP-172 C SOFTEK® for Blue Bird All American Buses – 13.2K/14.6K Capacity, Left Hand Drive Steertek Axle

OEM Part Number	Item No.	Description	Qty.
58913-010L	1	Shock Absorber	2
n/a	2	**3/4"-10 UNC Upper Shock Bolt	2
n/a	3	**3/4"-10 UNC Lower Shock Bolt	2
n/a	4	**3/4" Hardened Washer	6
n/a	5	**3/4"-10 UNC Hex Locknut	4
59946-001	6	Shock Spacer	2
65000-002	7	Shock Bracket	2
66625-001	8	Leaf Spring Assembly - 13.2K	2
66626-001	8	Leaf Spring Assembly - 14.6K	2
64488-002	9	Front Hanger	2
n/a	10	**M20 170 mm Hex Bolt	2
n/a	11	**M20 Hardened Washer	4
n/a	12	**M20 Locknut	2
66510-001	13	Rear Shackle Bracket	2
64314-000	14	Rear Shackle Plate	4
n/a	15	**M20 150 mm Hex Bolt	4
n/a	16	**M20 Hardened Washer	8
n/a	17	**M20 Locknut	4
60952-XXX		STEERTEK Axle Assembly, Contact Hendrickson Tech Services for Part No., Includes Item Nos. 18-43	1
64905-002	18	Axle & Kingpin Assembly, 6.8", 7.8", 8.8" and 9.8" Ride Height - 13.2K	1
64905-005	18	Axle & Kingpin Assembly, 6.8", 7.8", 8.8" and 9.8" Ride Height - 14.6K	1
58900-035	19	Left Hand Lower Steering Knuckle Assembly - 150 Ackermann Air Brake	1
58900-033	19	Left Hand Lower Steering Knuckle Assembly - 200 Ackermann Air Brake	1
58900-031	19	Left Hand Lower Steering Knuckle Assembly - 250 Ackermann Air Brake	1
58900-055	19	Left Hand Lower Steering Knuckle Assembly - 150 Ackermann Hydraulic Brake	1
58900-053	19	Left Hand Lower Steering Knuckle Assembly - 200 Ackermann Hydraulic Brake	1
58900-051	19	Left Hand Lower Steering Knuckle Assembly - 250 Ackermann Hydraulic Brake	1
58900-036	20	Right Hand Lower Steering Knuckle Assembly - 150 Ackermann Air Brake	1
58900-034	20	Right Hand Lower Steering Knuckle Assembly - 200 Ackermann Air Brake	1
58900-032	20	Right Hand Lower Steering Knuckle Assembly - 250 Ackermann Air Brake	1
58900-056	20	Right Hand Lower Steering Knuckle Assembly - 150 Ackermann Hydraulic Brake	1
58900-054	20	Right Hand Lower Steering Knuckle Assembly - 200 Ackermann Hydraulic Brake	1
58900-052	20	Right Hand Lower Steering Knuckle Assembly - 250 Ackermann Hydraulic Brake	1
60903-055	21	Left Hand Upper Steering Knuckle Assembly	1
60904-002	22	Right Hand Upper Steering Knuckle Assembly	1

NOTE:

* Item included in assembly only, part not sold separately.

** Not supplied by Hendrickson, used for reference only. Refer to OEM (vehicle manufacturer) for more information. Hendrickson is not responsible for components supplied by vehicle manufacturer. For assistance with maintenance and rebuild instructions on these components see vehicle manufacturer.

*** Hendrickson supplies different tie rod assemblies and each type may take a different replacement tie rod end kit to service. Prior to ordering, find the OEM Part Number on the tie rod tube, reference Hendrickson Publication No. SEU-0223 or contact Hendrickson Tech Services for corresponding kit numbers: 1-866-755-5968.

OEM Part Number	Item No.	Description	Qty.
60961-040		Kingpin Bushing and Bearing Service Kit, Axle Set, Includes Kit Nos. 60961-009 & 60961-039	
60961-009		Left Hand Kingpin Bushing w/Composite Thrust Bearing Service Kit, Includes Item Nos. 23-26, 28-30, Loctite	
60961-039		Right Hand Kingpin Bushing w/Roller Thrust Bearing Service Kit, Includes Item Nos. 23-25, 27-30, Loctite	
59156-000	23	Grease Cap Assembly	4
58937-000	24	Retaining Ring	4
58909-000	25	Kingpin Bushing	4
60961-043		Thrust Bearing Service Kit, Axle Set, Includes Kit Nos. 60961-041& -042	
60961-041		Left Hand Composite Thrust Bearing Service Kit, Includes Item Nos. 26, 28-30, Loctite	
60961-042		Right Hand Roller Thrust Bearing Service Kit, Includes Item Nos. 27-30, Loctite	
59828-000	26	Left Hand Composite Thrust Bearing	1
64256-000	27	Right Hand Roller Thrust Bearing	1
60259-002	28	Kingpin Shim - 0.047"	2
60259-001	Not Shown	Kingpin Shim - 0.005" (As needed for service)	
58910-001	29	Kingpin Seal, Replaces 58910-000	4
60236-001	30	5/8"-11 UNC Socket Head Cap Screw	4
60937-000	Not Shown	Loctite (Red) Compound Tube	1
64246-000	31	ABS Sensor Sleeve	2
64006-002	32	***Tie Rod Assembly, 14.6K, 5.36 Drop, Includes Item Nos. 33-37 - 150/200 Ackermann	1
64006-003	32	***Tie Rod Assembly, 14.6K, 5.36 Drop, Includes Item Nos. 33-37 - 250 Ackermann	1
n/a	33	*7/8" Castle Nut	2
60961-011		***Tie Rod End Service Kit, Axle Set, Includes Kit Nos. 60961-027 & -028	
60961-027		***Left Hand Tie Rod End Service Kit, Includes Item Nos. 34, 36-37	
60961-028		***Right Hand Tie Rod End Service Kit, Includes Item Nos. 35-37	
64002-001	34	***Left Hand Tie Rod End	1
64002-002	35	***Right Hand Tie Rod End	1
22962-007	36	7/8" Flat Washer	2
17800-004	37	Tie Rod Nut Cotter Pin	2
60961-069		Stop Bolt Service Kit, One Side, Includes Item Nos. 38-39	
60238-001	38	1/2"-13 UNC Square Head Bolt	2
60240-000	39	1/2"-13 UNC Hex Jam Nut	2
59952-026	40	Top Axle Wrap	2
64722-003	41	Bottom Axle Wrap	2
60961-015		Top/Bottom Axle Wrap Liner Service Kit, One Side, Includes Item Nos. 42-43	

NOTE:
 * Item included in assembly only, part not sold separately.
 ** Not supplied by Hendrickson, used for reference only. Refer to OEM (vehicle manufacturer) for more information. Hendrickson is not responsible for components supplied by vehicle manufacturer. For assistance with maintenance and rebuild instructions on these components see vehicle manufacturer.
 *** Hendrickson supplies different tie rod assemblies and each type may take a different replacement tie rod end kit to service. Prior to ordering, find the OEM Part Number on the tie rod tube, reference Hendrickson Publication No. SEU-0223 or contact Hendrickson Tech Services for corresponding kit numbers: 1-866-755-5968.

OEM Part Number	Item No.	Description	Qty.
60508-000	42	Top Axle Wrap Liner	2
59845-000	43	Bottom Axle Wrap Liner	2
60961-142		Clamp Group Service Kit, One side, Includes Item Nos. 44-46 - 6.8" Ride Height	
60961-143		Clamp Group Service Kit, One side, Includes Item Nos. 44-46 - 7.8" Ride Height	
60961-144		Clamp Group Service Kit, One side, Includes Item Nos. 44-46 - 8.8" Ride Height	
60961-145		Clamp Group Service Kit, One side, Includes Item Nos. 44-46 - 9.8" Ride Height	
64804-120	44	3/4"-16 UNF U-bolt - 6.8" Ride Height - 12.0"	4
64804-130	44	3/4"-16 UNF U-bolt - 7.8" Ride Height - 13.0"	4
64804-140	44	3/4"-16 UNF U-bolt - 8.8" Ride Height - 14.0"	4
64804-150	44	3/4"-16 UNF U-bolt - 9.8" Ride Height - 15.0"	4
22962-001	45	3/4" Flat Washer	8
17700-035	46	3/4"-16 UNF-2B Nylon Locknut	8
n/a	47	Dowel Pin - 6.8" Ride Height	None Req.
18831-022	47	Dowel Pin - 7.8" Ride Height - 1.13"	2
18831-021	47	Dowel Pin - 8.8" Ride Height - 2.0"	2
18831-023	47	Dowel Pin - 9.8" Ride Height - 3.0"	2
66806-001		Top Pad/Axle Stop Assembly, Includes Item Nos. 48-49	
66666-000	48	Top Pad	2
64080-000	49	Rubber Axle Stop	2
64536-010	50	Left Hand Front Axle Spacer - 6.8" Ride Height	1
64536-035	50	Left Hand Front Axle Spacer - 7.8" Ride Height	1
64536-060	50	Left Hand Front Axle Spacer - 8.8" Ride Height	1
64536-085	50	Left Hand Front Axle Spacer - 9.8" Ride Height	1
n/a	51	Right Hand Front Axle Spacer - 6.8" Ride Height	None Req.
64536-025	51	Right Hand Front Axle Spacer - 7.8" Ride Height	1
64536-050	51	Right Hand Front Axle Spacer - 8.8" Ride Height	1
64536-075	51	Right Hand Front Axle Spacer - 9.8" Ride Height	1

NOTE:
 * Item included in assembly only, part not sold separately.
 ** Not supplied by Hendrickson, used for reference only. Refer to OEM (vehicle manufacturer) for more information. Hendrickson is not responsible for components supplied by vehicle manufacturer. For assistance with maintenance and rebuild instructions on these components see vehicle manufacturer.
 *** Hendrickson supplies different tie rod assemblies and each type may take a different replacement tie rod end kit to service. Prior to ordering, find the OEM Part Number on the tie rod tube, reference Hendrickson Publication No. SEU-0223 or contact Hendrickson Tech Services for corresponding kit numbers: 1-866-755-5968.

**SP-172C AIRTEK® - BLUE BIRD ALL AMERICAN BUSES
13.2K/14.6K CAPACITY, RH DRIVE STEERTEK AXLE**

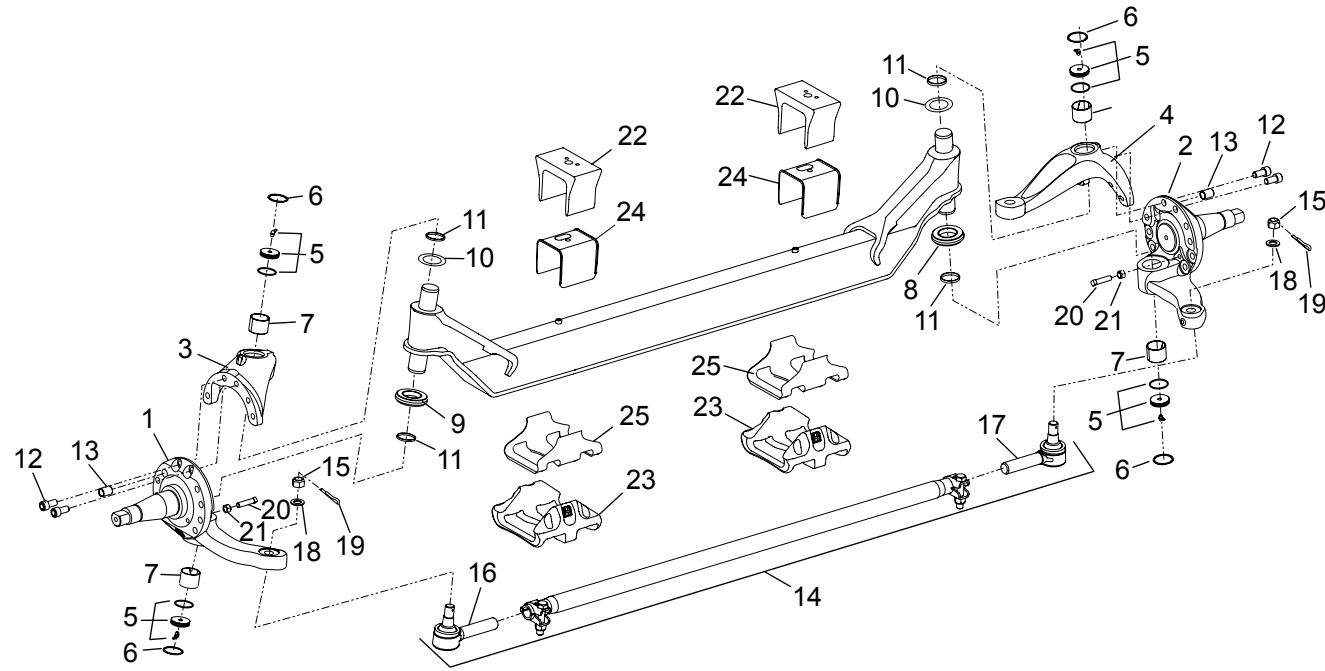


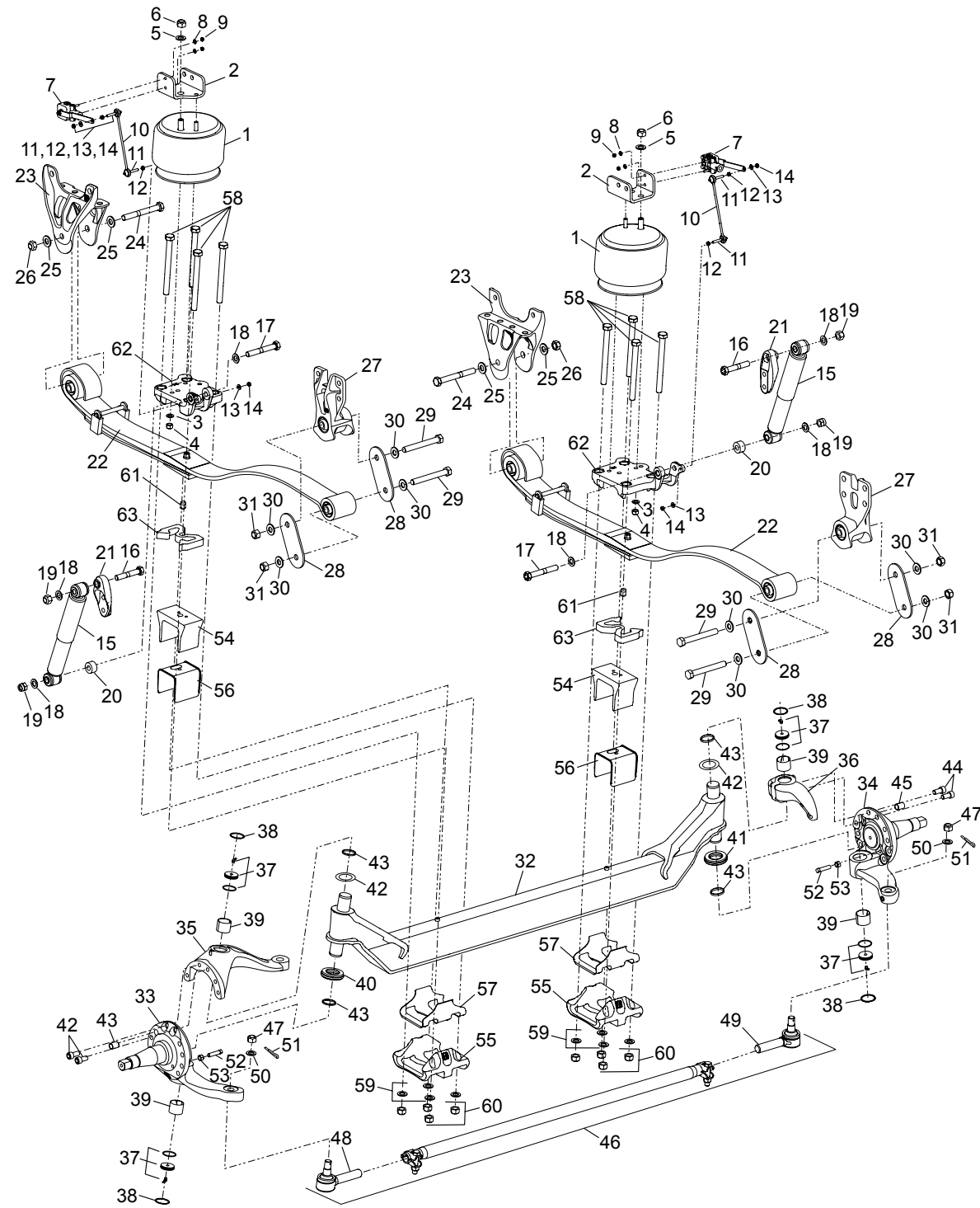
Table 6-38: SP-172 C AIRTEK® for Blue Bird All American Buses – 13.2K/14.6K Capacity, Right Hand Drive Steertek Axle

OEM Part Number	Item No.	Description	Qty.
67905-402		STEERTEK Axle Assembly, Includes Item Nos. 1-25 - SOFTEK Standard Drop - 13.2K	1
67905-404		STEERTEK Axle Assembly, Includes Item Nos. 1-25 - AIRTEK Deep Drop - 13.2K	1
67905-405		STEERTEK Axle Assembly, Includes Item Nos. 1-25 - SOFTEK Standard Drop - 14.6K	1
67905-407		STEERTEK Axle Assembly, Includes Item Nos. 1-25 - AIRTEK Deep Drop - 14.6K	1
58900-035	1	Left Hand Lower Steering Knuckle Assembly - 150 Ackermann Air Brake	1
58900-033	1	Left Hand Lower Steering Knuckle Assembly - 200 Ackermann Air Brake	1
58900-031	1	Left Hand Lower Steering Knuckle Assembly - 250 Ackermann Air Brake	1
58900-055	1	Left Hand Lower Steering Knuckle Assembly - 150 Ackermann Hydraulic Brake	1
58900-053	1	Left Hand Lower Steering Knuckle Assembly - 200 Ackermann Hydraulic Brake	1
58900-051	1	Left Hand Lower Steering Knuckle Assembly - 250 Ackermann Hydraulic Brake	1
58900-036	2	Right Hand Lower Steering Knuckle Assembly - 150 Ackermann Air Brake	1
58900-034	2	Right Hand Lower Steering Knuckle Assembly - 200 Ackermann Air Brake	1
58900-032	2	Right Hand Lower Steering Knuckle Assembly - 250 Ackermann Air Brake	1
58900-056	2	Right Hand Lower Steering Knuckle Assembly - 150 Ackermann Hydraulic Brake	1

NOTE:
 * Item included in assembly only, part not sold separately.
 ** Not supplied by Hendrickson, used for reference only. Refer to OEM (vehicle manufacturer) for more information. Hendrickson is not responsible for components supplied by vehicle manufacturer. For assistance with maintenance and rebuild instructions on these components see vehicle manufacturer.
 *** Hendrickson supplies different tie rod assemblies and each type may take a different replacement tie rod end kit to service. Prior to ordering, find the OEM Part Number on the tie rod tube, reference Hendrickson Publication No. SEU-0223 or contact Hendrickson Tech Services for corresponding kit numbers: 1-866-755-5968.

OEM Part Number	Item No.	Description	Qty.
58900-054	2	Right Hand Lower Steering Knuckle Assembly - 200 Ackermann Hydraulic Brake	1
58900-052	2	Right Hand Lower Steering Knuckle Assembly - 250 Ackermann Hydraulic Brake	1
60904-001	3	Left Hand Upper Steering Knuckle Assembly	1
70903-001	4	Right Hand Upper Steering Knuckle Assembly	1
60961-040		Kingpin Bushing and Bearing Service Kit, Axle Set, Includes Kit Nos. 60961-009 & 60961-039	
60961-009		Right Hand Kingpin Bushing w/Composite Thrust Bearing Service Kit, Includes Item Nos. 5-8, 10-12, Loctite	
60961-039		Left Hand Kingpin Bushing w/Roller Thrust Bearing Service Kit, Includes Item Nos. 5-7, 9-12, Loctite	
59156-000	5	Grease Cap Assembly	4
58937-000	6	Retaining Ring	4
58909-000	7	Kingpin Bushing	4
60961-043		Thrust Bearing Service Kit, Axle Set, Includes Kit Nos. 60961-041 & -042	
60961-041		Right Hand Composite Thrust Bearing Service Kit, Includes Item Nos. 8, 10-12, Loctite	
60961-042		Left Hand Roller Thrust Bearing Service Kit, Includes Item Nos. 9-12, Loctite	
59828-000	8	Right Hand Composite Thrust Bearing	1
64256-000	9	Left Hand Roller Thrust Bearing	1
60259-002	10	Kingpin Shim - 0.047"	2
60259-001	Not Shown	Kingpin Shim - 0.005" (As needed for service)	
58910-001	11	Kingpin Seal, Replaces 58910-000	4
60236-001	12	5/8"-11 UNC Socket Head Cap Screw	4
60937-000	Not Shown	Loctite (Red) Compound Tube	1
64246-000	13	ABS Sensor Sleeve	2
60239-005	14	Tie Rod Assembly, 13.2K, Includes Item Nos. 15-19 - 150/200 Ackermann	1
60239-001	14	Tie Rod Assembly, 13.2K, Includes Item Nos. 15-19 - 250 Ackermann	1
n/a	15	*7/8" Castle Nut	2
60961-010		Tie Rod End Service Kit, Axle Set, Includes Kit Nos. 60961-025 & -026	
60961-025		Left Hand Tie Rod End Service Kit, Includes Item Nos. 16, 18-19	
60961-026		Right Hand Tie Rod End Service Kit, Includes Item Nos. 17-19	
64000-001	16	Left Hand Tie Rod End	1
64000-002	17	Right Hand Tie Rod End	1
22962-007	18	7/8" Flat Washer	2
17800-004	19	Tie Rod Nut Cotter Pin	2
60961-069		Stop Bolt Service Kit, One Side, Includes Nos. 20-21	
60238-001	20	1/2"-13 UNC Square Head Bolt	2
60240-000	21	1/2"-13 UNC Hex Jam Nut	2
59952-026	22	Top Axle Wrap - 13.2K	2
59952-031		Top Axle Wrap - 14.6K	
64722-003	23	Bottom Axle Wrap	2
60961-015		Top/Bottom Axle Wrap Liner Service Kit, One Side, Includes Nos. 24-25	
60508-000	24	Top Axle Wrap Liner	2
59845-000	25	Bottom Axle Wrap Liner	2

SP-172 C AIRTEK® - BLUE BIRD ALL AMERICAN BUSES – 14.6K CAPACITY, LH DRIVE STEERTEK AXLE



SP-172 C AIRTEK® for Blue Bird All American Buses – 14.6K Capacity, Left Hand Drive Steertek Axle

OEM Part Number	Item No.	Description	Qty.
66865-002L	1	Air Spring	2
66807-001	2	Air Spring Bracket	2
22962-014	3	1/2" Hardened Washer	2
17730-015	4	1/2"-13 UNC Nylon Locknut	2
n/a	5	**3/4" Hardened Washer	2
n/a	6	**3/4"-10 UNC Nylon Locknut	2
59013-000		Height Control Valve Assembly, Includes Item Nos. 7-9	2
60501-000	7	Height Control Valve	2
22962-028	8	1/4" Hardened Washer	4
9983-000	9	1/4"-20 UNC Locknut	4
66825-001		HCV Linkage Assembly, Includes Item Nos. 10-14	2
59428-005	10	HCV Linkage	2
n/a	11	*5/16"-18 UNC 2.44" Stud	4
n/a	12	*5/16"-18 UNC Hex Nut	4
n/a	13	*5/16" Hardened Washer	4
n/a	14	*5/16"-18 UNC Locknut	4
58913-011L	15	Shock Absorber	2
n/a	16	**3/4"-10 UNC Upper Shock Bolt	2
n/a	17	**3/4"-10 UNC Lower Shock Bolt	2
n/a	18	**3/4" Hardened Washer	6
n/a	19	**3/4"-10 UNC Hex Locknut	4
59946-006	20	Shock Spacer	2
65000-002	21	Shock Bracket	2
66805-001	22	Leaf Spring Assembly	2
64488-002	23	Front Hanger	2
n/a	24	**M20 170 mm Hex Bolt	2
n/a	25	**M20 Hardened Washer	4
n/a	26	**M20 Locknut	2
66510-001	27	Rear Shackle Bracket	2
64314-000	28	Rear Shackle Plate	4
n/a	29	**M20 150 mm Hex Bolt	4
n/a	30	**M20 Hardened Washer	8
n/a	31	**M20 Locknut	4
60952-XXX		Axle Assembly, Includes Item Nos. 32-57, Contact Hendrickson Tech Services for Part No.	1

NOTE:

* Item included in assembly only, part not sold separately.

** Not supplied by Hendrickson, used for reference only. Refer to OEM (vehicle manufacturer) for more information. Hendrickson is not responsible for components supplied by vehicle manufacturer. For assistance with maintenance and rebuild instructions on these components see vehicle manufacturer.

*** Hendrickson supplies different tie rod assemblies and each type may take a different replacement tie rod end kit to service. Prior to ordering, find the OEM Part Number on the tie rod tube, reference Hendrickson Publication No. SEU-0223 or contact Hendrickson Tech Services for corresponding kit numbers: 1-866-755-5968.

OEM Part Number	Item No.	Description	Qty.
64905-004	32	Axle & Kingpin Assembly, 6.8", 7.8", 8.8" and 9.8" Ride Height - 13.2K	1
64905-007	32	Axle & Kingpin Assembly, 6.8", 7.8", 8.8" and 9.8" Ride Height - 14.6K	1
58900-035	33	Left Hand Lower Steering Knuckle Assembly - 150 Ackermann Air Brake	1
58900-033	33	Left Hand Lower Steering Knuckle Assembly - 200 Ackermann Air Brake	1
58900-031	33	Left Hand Lower Steering Knuckle Assembly - 250 Ackermann Air Brake	1
58900-055	33	Left Hand Lower Steering Knuckle Assembly - 150 Ackermann Hydraulic Brake	1
58900-053	33	Left Hand Lower Steering Knuckle Assembly - 200 Ackermann Hydraulic Brake	1
58900-051	33	Left Hand Lower Steering Knuckle Assembly - 250 Ackermann Hydraulic Brake	1
58900-036	34	Right Hand Lower Steering Knuckle Assembly - 150 Ackermann Air Brake	1
58900-034	34	Right Hand Lower Steering Knuckle Assembly - 200 Ackermann Air Brake	1
58900-032	34	Right Hand Lower Steering Knuckle Assembly - 250 Ackermann Air Brake	1
58900-056	34	Right Hand Lower Steering Knuckle Assembly - 150 Ackermann Hydraulic Brake	1
58900-054	34	Right Hand Lower Steering Knuckle Assembly - 200 Ackermann Hydraulic Brake	1
58900-052	34	Right Hand Lower Steering Knuckle Assembly - 250 Ackermann Hydraulic Brake	1
60903-055	35	Left Hand Upper Steering Knuckle Assembly	1
60904-002	36	Right Hand Upper Steering Knuckle Assembly	1
60961-040		Kingpin Bushing and Bearing Service Kit, Axle Set, Includes Kit Nos. 60961-009 & 60961-039	
60961-009		Left Hand Kingpin Bushing w/Composite Thrust Bearing Service Kit, Includes Item Nos. 37-40, 42-44, Loctite	
60961-039		Right Hand Kingpin Bushing w/Roller Thrust Bearing Service Kit, Includes Item Nos. 37-39, 41-44, Loctite	
59156-000	37	Grease Cap Assembly	4
58937-000	38	Retaining Ring	4
58909-000	39	Kingpin Bushing	4
60961-043		Thrust Bearing Service Kit, Axle Set, Includes Kit Nos. 60961-041 & 60961-042	
60961-041		Left Hand Composite Thrust Bearing Service Kit, Includes Item Nos. 40, 42-44, Loctite	
60961-042		Right Hand Roller Thrust Bearing Service Kit, Includes Item Nos. 41-44, Loctite	
59828-000	40	Left Hand Composite Thrust Bearing	1
64256-000	41	Right Hand Roller Thrust Bearing	1
60259-002	42	Kingpin Shim - 0.047"	2
60259-001	Not Shown	Kingpin Shim - 0.005" (As needed for service)	
58910-001	43	Kingpin Seal, Replaces 58910-000	4
60236-001	44	5/8"-11 UNC Socket Head Cap Screw	4
60937-000	Not Shown	Loctite (Red) Compound Tube	1
64246-000	45	ABS Sensor Sleeve	2
64006-002	46	***Tie Rod Assembly, 14.6K, 5.36 Drop, Includes Item Nos. 47-51 - 150/200 Ackermann	1
64006-003	46	***Tie Rod Assembly, 14.6K, 5.36 Drop, Includes Item Nos. 47-51 - 250 Ackermann	1
n/a	47	7/8" Castle Nut *	2

NOTE:

* Item included in assembly only, part not sold separately.

** Not supplied by Hendrickson, used for reference only. Refer to OEM (vehicle manufacturer) for more information.

Hendrickson is not responsible for components supplied by vehicle manufacturer. For assistance with maintenance and rebuild instructions on these components see vehicle manufacturer.

*** Hendrickson supplies different tie rod assemblies and each type may take a different replacement tie rod end kit to service. Prior to ordering, find the OEM Part Number on the tie rod tube, reference Hendrickson Publication No. SEU-0223 or contact Hendrickson Tech Services for corresponding kit numbers: 1-866-755-5968.

OEM Part Number	Item No.	Description	Qty.
60961-011		Tie Rod End Service Kit, Axle Set, Includes Kit Nos. 60961-027 & -028 ***	
60961-027		Left Hand Tie Rod End Service Kit, Includes Item Nos. 48, 50-51 ***	
60961-028		Right Hand Tie Rod End Service Kit, Includes Item Nos. 49-51 ***	
64002-001	48	Left Hand Tie Rod End ***	1
64002-002	49	Right Hand Tie Rod End ***	1
22962-007	50	7/8" Flat Washer	2
17800-004	51	Tie Rod Nut Cotter Pin	2
60961-069		Stop Bolt Service Kit, One Side, Includes Item Nos. 52-53	
60238-001	52	1/2"-13 UNC Square Head Bolt	2
60240-000	53	1/2"-13 UNC Hex Jam Nut	2
59952-026	54	Top Axle Wrap	2
64722-003	55	Bottom Axle Wrap	2
60961-015		Top/Bottom Axle Wrap Liner Service Kit, One Side, Includes Item Nos. 56-57	
60508-000	56	Top Axle Wrap Liner	2
59845-000	57	Bottom Axle Wrap Liner 2	
60961-051		Clamp Group Service Kit, One side, Includes Item Nos. 58-60 - 6.8" Ride Height	
60961-146		Clamp Group Service Kit, One side, Includes Item Nos. 58-60 - 7.8" Ride Height	
60961-052		Clamp Group Service Kit, One side, Includes Item Nos. 58-60 - 8.8" Ride Height	
60961-147		Clamp Group Service Kit, One side, Includes Item Nos. 58-60 - 9.8" Ride Height	
21867-044	58	3/4"-16 UNF Hex bolt - 6.8" Ride Height - 10.0"	8
21867-027	58	3/4"-16 UNF Hex bolt - 7.8" Ride Height - 11.0"	8
21867-045	58	3/4"-16 UNF Hex bolt - 8.8" Ride Height - 12.0"	8
21867-035	58	3/4"-16 UNF Hex bolt - 9.8" Ride Height - 13.0"	8
22962-001	59	3/4" Flat Washer	8
17700-035	60	3/4"-16 UNF-2B Nylon Locknut	8
n/a	61	Dowel Pin - 6.8" Ride Height	None Req.
18831-022	61	Dowel Pin - 7.8" Ride Height - 1.13"	2
18831-021	61	Dowel Pin - 8.8" Ride Height - 2.0"	2
18831-023	61	Dowel Pin - 9.8" Ride Height - 3.0"	2
66814-001	62	Top Pad - Left Hand	1
66814-002	62	Top Pad - Right Hand	1
n/a	63	Left Hand/Right Hand Front Axle Spacer - 6.8" Ride Height	None Req.
64536-025	63	Left Hand/Right Hand Front Axle Spacer - 7.8" Ride Height	2
64536-050	63	Left Hand/Right Hand Front Axle Spacer - 8.8" Ride Height	2
64536-075	63	Left Hand/Right Hand Front Axle Spacer - 9.8" Ride Height	2

NOTE:

* Item included in assembly only, part not sold separately.

** Not supplied by Hendrickson, used for reference only. Refer to OEM (vehicle manufacturer) for more information.

Hendrickson is not responsible for components supplied by vehicle manufacturer. For assistance with maintenance and rebuild instructions on these components see vehicle manufacturer.

*** Hendrickson supplies different tie rod assemblies and each type may take a different replacement tie rod end kit to service. Prior to ordering, find the OEM Part Number on the tie rod tube, reference Hendrickson Publication No. SEU-0223 or contact Hendrickson Tech Services for corresponding kit numbers: 1-866-755-5968.

SP-172 C SOFTEK® - BLUE BIRD VISION BUSES – 8K/10K CAPACITY

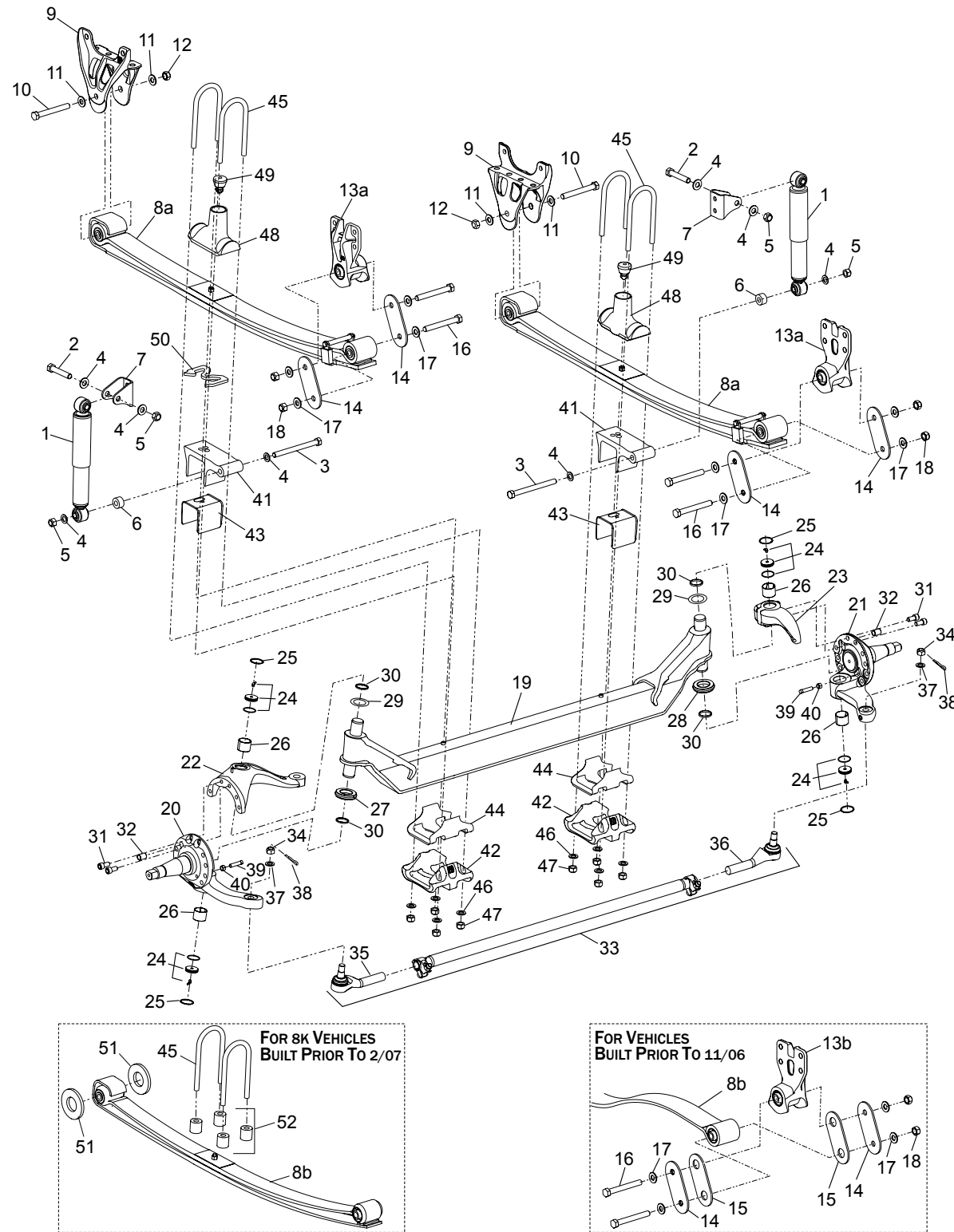


Table 6-39: SP-172 C SOFTEK® for Blue Bird Vision Buses – 8K/10K Capacity

OEM Part Number	Item No.	Description	Qty.
58913-009L	1	Shock Absorber, Replaces 58913-007	2
n/a	2	3/4"-10 UNC Upper Shock Bolt**	2
n/a	3	3/4"-10 UNC Lower Shock Bolt**	2
n/a	4	3/4" Hardened Washer**	8
n/a	5	3/4"-10 UNC Hex Locknut**	4
59946-001	6	Shock Spacer	2
59423-002	7	Shock Bracket	2
60961-161		Leaf Spring Assembly Service Kit - 8K, Vehicles built after 11/06, Includes Item Nos. 8a, 14	
60961-162		Leaf Spring Assembly Service Kit - 10K, Vehicles built after 11/06, Includes Item Nos. 8a, 13a, 14	
66623-001	8a	Leaf Spring Assembly - 8K, Vehicles built after 11/06	2
66624-001	8a	Leaf Spring Assembly - 10K, Vehicles built after 11/06	2
66364-000	8b	Leaf Spring Assembly - 8K, Vehicles built prior to 11/06	2
60511-000	8b	Leaf Spring Assembly - 10K, Vehicles built prior to 11/06	2
64488-002	9	Front Hanger, Replaces 64488-000	2
n/a	10	M20 170 mm Hex Bolt**	2
n/a	11	M20 Hardened Washer**	4
n/a	12	M20 Locknut**	2
66510-001	13a	Rear Shackle Bracket, Vehicles built after 11/06	2
64316-000	13b	Rear Shackle Bracket, Vehicles built prior to 11/06	2
64314-000	14	Rear Shackle Plate	4
64159-000	15	Thrust Washer, Only for vehicles built prior to 11/06	4
n/a	16	M20 150 mm Hex Bolt**	4
n/a	17	M20 Hardened Washer**	8
n/a	18	M20 Locknut**	4
60952-XXX		STEERTEK Axle Assembly, Contact Hendrickson Tech Services for Part No., Includes Item Nos. 19-44	1
64905-004	19	Axle & Kingpin Assembly, 6.5", 8.5" Ride Height	1
58900-035	20	Left Hand Lower Steering Knuckle Assembly - 150 Ackermann Air Brake	1
58900-033	20	Left Hand Lower Steering Knuckle Assembly - 200 Ackermann Air Brake	1
58900-031	20	Left Hand Lower Steering Knuckle Assembly - 250 Ackermann Air Brake	1
58900-055	20	Left Hand Lower Steering Knuckle Assembly - 150 Ackermann Hydraulic Brake	1
58900-053	20	Left Hand Lower Steering Knuckle Assembly - 200 Ackermann Hydraulic Brake	1
58900-051	20	Left Hand Lower Steering Knuckle Assembly - 250 Ackermann Hydraulic Brake	1
58900-036	21	Right Hand Lower Steering Knuckle Assembly - 150 Ackermann Air Brake	1

NOTE:

* Item included in assembly only, part not sold separately.

** Not supplied by Hendrickson, used for reference only. Refer to OEM (vehicle manufacturer) for more information. Hendrickson is not responsible for components supplied by vehicle manufacturer. For assistance with maintenance and rebuild instructions on these components see vehicle manufacturer.

*** Hendrickson supplies different tie rod assemblies and each type may take a different replacement tie rod end kit to service. Prior to ordering, find the OEM Part Number on the tie rod tube, reference Hendrickson Publication No. SEU-0223 or contact Hendrickson Tech Services for corresponding kit numbers: 1-866-755-5968.

OEM Part Number	Item No.	Description	Qty.
58900-034	21	Right Hand Lower Steering Knuckle Assembly - 200 Ackermann Air Brake	1
58900-032	21	Right Hand Lower Steering Knuckle Assembly - 250 Ackermann Air Brake	1
58900-056	21	Right Hand Lower Steering Knuckle Assembly - 150 Ackermann Hydraulic Brake	1
58900-054	21	Right Hand Lower Steering Knuckle Assembly - 200 Ackermann Hydraulic Brake	1
58900-052	21	Right Hand Lower Steering Knuckle Assembly - 250 Ackermann Hydraulic Brake	1
60903-016	22	Left Hand Upper Steering Knuckle Assembly	1
60904-002	23	Right Hand Upper Steering Knuckle Assembly	1
60961-040		Kingpin Bushing and Bearing Service Kit, Axle Set, Includes Kit Nos. 60961-009 & 60961-039	
60961-009		Left Hand Kingpin Bushing w/Composite Thrust Bearing Service Kit, Includes Item Nos. 24-27, 29-31, Loctite	
60961-039		Right Hand Kingpin Bushing w/Roller Thrust Bearing Service Kit, Includes Item Nos. 24-26, 28-31, Loctite	
59156-000	24	Grease Cap Assembly	4
58937-000	25	Retaining Ring	4
58909-000	26	Kingpin Bushing	4
60961-043		Thrust Bearing Service Kit, Axle Set, Includes Kit Nos. 60961-041 & -042	
60961-041		Left Hand Composite Thrust Bearing Service Kit, Includes Item Nos. 27, 29-31, Loctite	
60961-042		Right Hand Roller Thrust Bearing Service Kit, Includes Item Nos. 28-31, Loctite	
59828-000	27	Left Hand Composite Thrust Bearing	1
64256-000	28	Right Hand Roller Thrust Bearing	1
60259-002	29	Kingpin Shim - 0.047"	2
60259-001	Not Shown	Kingpin Shim - 0.005" (As needed for service)	
58910-001	30	Kingpin Seal, Replaces 58910-000	4
60236-001	31	5/8"-11 UNC Socket Head Cap Screw	4
60937-000	Not Shown	Loctite (Red) Compound Tube	1
64246-000	32	ABS Sensor Sleeve 2	
66699-003	33	Tie Rod Assembly, 10K, 5.36 Drop, Includes Item Nos. 34-38 - 200 Ackermann, Replaces 59948-005***	1
66699-001	33	Tie Rod Assembly, 10K, 5.36 Drop, Includes Item Nos. 34-38 - 250 Ackermann, Replaces 59948-006***	1
n/a	34	7/8" Castle Nut *	2
60961-139		Tie Rod End Service Kit, Axle Set, Replaces 60961-012, Includes Kit Nos. 60961-137 & -138***	
60961-137		Left Hand Tie Rod End Service Kit, Replaces 60961-029, Includes Item Nos. 35, 37-38***	
60961-138		Right Hand Tie Rod End Service Kit, Replaces 60961-030, Includes Item Nos. 36-38***	
66645-001	35	Left Hand Tie Rod End, Replaces 64004-001***	1
66645-002	36	Right Hand Tie Rod End, Replaces 64004-002***	1

NOTE:
 * Item included in assembly only, part not sold separately.
 ** Not supplied by Hendrickson, used for reference only. Refer to OEM (vehicle manufacturer) for more information. Hendrickson is not responsible for components supplied by vehicle manufacturer. For assistance with maintenance and rebuild instructions on these components see vehicle manufacturer.
 *** Hendrickson supplies different tie rod assemblies and each type may take a different replacement tie rod end kit to service. Prior to ordering, find the OEM Part Number on the tie rod tube, reference Hendrickson Publication No. SEU-0223 or contact Hendrickson Tech Services for corresponding kit numbers: 1-866-755-5968.

OEM Part Number	Item No.	Description	Qty.
22962-007	37	7/8" Flat Washer	2
17800-004	38	Tie Rod Nut Cotter Pin	2
60961-069		Stop Bolt Service Kit, One Side, Includes Item Nos. 39-40	
60238-001	39	1/2"-13 UNC Square Head Bolt 2	
60240-000	40	1/2"-13 UNC Hex Jam Nut	2
59952-003	41	Top Axle Wrap	2
64722-003	42	Bottom Axle Wrap	2
60961-015		Top/Bottom Axle Wrap Liner Service Kit, One Side, Includes Item Nos. 43-44	
60508-000	43	Top Axle Wrap Liner	2
59845-000	44	Bottom Axle Wrap Liner	2
60961-140		Clamp Group Service Kit, One side, Includes Item Nos. 45-47 - 6.5" Ride Height	
60961-141		Clamp Group Service Kit, One side, Includes Item Nos. 45-47 - 8.5" Ride Height	
n/a	45	3/4"-16 UNF U-bolt - 64804-110 6.5" Ride Height - 11.0" *	4
n/a	45	3/4"-16 UNF U-bolt - 64804-130 8.5" Ride Height - 13.0" *	4
22962-001	46	3/4" Flat Washer	8
17700-035	47	3/4"-16 UNF-2B Nylon Locknut	8
18831-021	Not Shown	Dowel Pin, 8.5" Ride Height - 2.0"	1
64506-000		Top Pad/Axle Stop Assembly, Includes Item Nos. 48-49	
64519-000	48	Top Pad	2
64080-000	49	Rubber Axle Stop	2
64536-010	50	Front Axle Spacer - Left Hand 6.5" Ride Height	1
64536-060	50	Front Axle Spacer - Left Hand 8.5" Ride Height	1
64536-050	Not Shown	Front Axle Spacer - Right Hand 8.5" Ride Height	1
66164-000	51	Thrust Pad Washer, 8K vehicles built prior to 2/07	2
66366-001	52	Clamp Group Spacer, 8K vehicles built prior to 2/07	4

NOTE:
 * Item included in assembly only, part not sold separately.
 ** Not supplied by Hendrickson, used for reference only. Refer to OEM (vehicle manufacturer) for more information. Hendrickson is not responsible for components supplied by vehicle manufacturer. For assistance with maintenance and rebuild instructions on these components see vehicle manufacturer.
 *** Hendrickson supplies different tie rod assemblies and each type may take a different replacement tie rod end kit to service. Prior to ordering, find the OEM Part Number on the tie rod tube, reference Hendrickson Publication No. SEU-0223 or contact Hendrickson Tech Services for corresponding kit numbers: 1-866-755-5968.

SP-172 C AIRTEK® - BLUE BIRD VISION BUSES – 10K CAPACITY

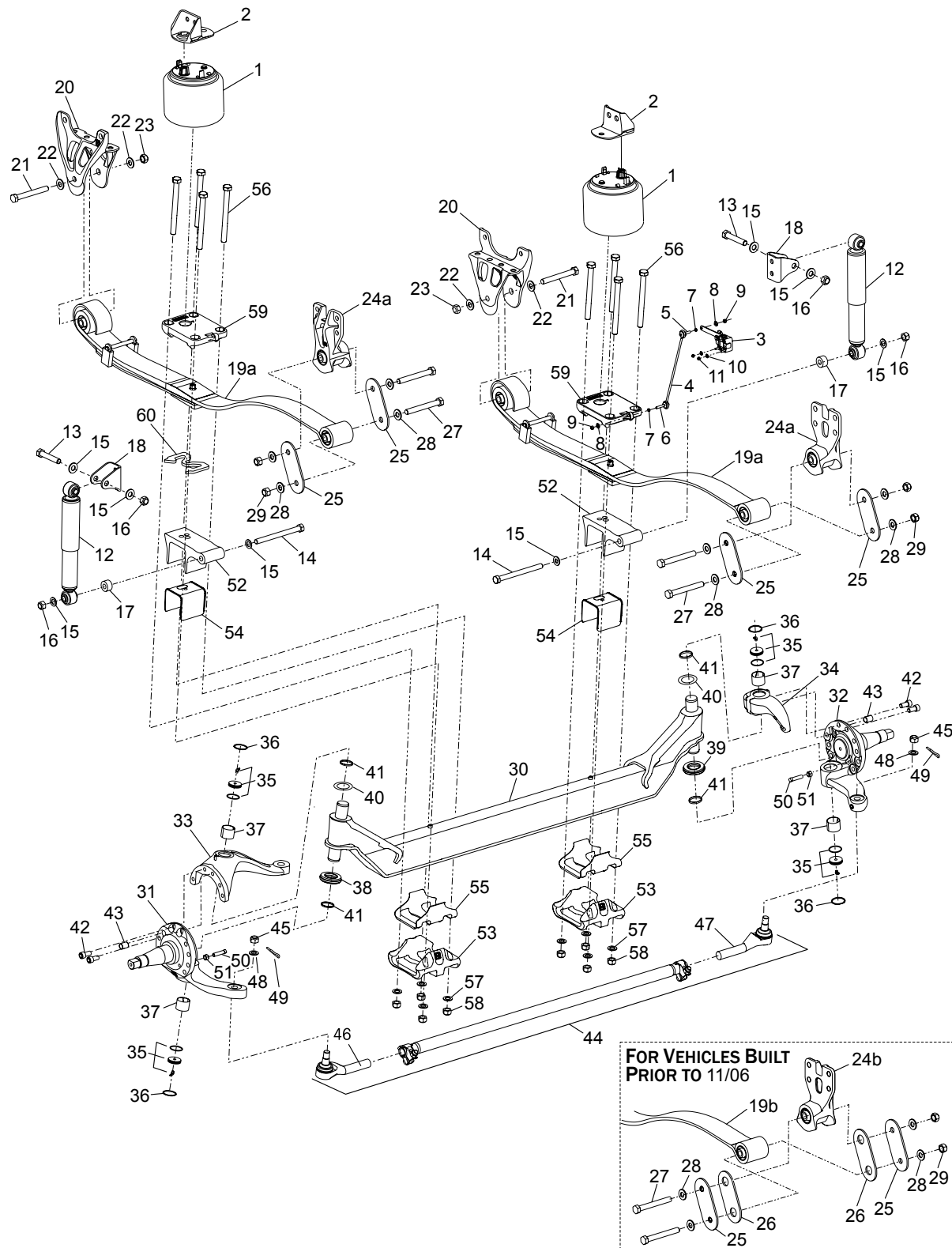


Table 6-40: SP-172 C AIRTEK® for Blue Bird Vision Buses – 10K Capacity

OEM Part Number	Item No.	Description	Qty.
64075-002L	1	Air Spring	2
60850-001	2	Air Spring Bracket	2
59427-008		HCV, Link Mount & Linkage Assembly, Includes Item Nos. 3-11	1
59935-004	3	Height Control Valve	1
59428-006	4	HCV Linkage, Replaces 59428-001	1
64742-001		Link Mount Service Kit, Includes Item Nos. 5-6	
n/a	5	5/16"-18 UNC 2.07" Stud*	1
n/a	6	5/16"-18 UNC 2.44" Stud*	1
n/a	7	5/16"-18 UNC Hex Nut*	2
n/a	8	5/16" Hardened Washer*	2
n/a	9	5/16"-18 UNC Locknut*	2
n/a	10	1/4" Hardened Washer*	2
n/a	11	1/4"-20 UNC Locknut*	2
58913-009L	12	Shock Absorber, Replaces 58913-008	2
n/a	13	3/4"-10 UNC Upper Shock Bolt **	2
n/a	14	3/4"-10 UNC Lower Shock Bolt **	2
n/a	15	3/4" Hardened Washer **	8
n/a	16	3/4"-10 UNC Hex Locknut **	4
59946-001	17	Shock Spacer	2
59423-002	18	Shock Bracket	2
60961-163		Leaf Spring Assembly Service Kit, Vehicles built prior to 11/06, Includes Item Nos. 19a, 24a, 25	
66805-001	19a	Leaf Spring Assembly, Vehicles built after 11/06	2
60512-000	19b	Leaf Spring Assembly, Vehicles built prior to 11/06	2
64488-002	20	Front Hanger, Replaces 64488-000	2
n/a	21	M20 170 mm Hex Bolt **	2
n/a	22	M20 Hardened Washer **	4
n/a	23	M20 Locknut **	2
66510-001	24a	Rear Shackle Bracket, Vehicles built after 11/06	2
64316-000	24b	Rear Shackle Bracket, Vehicles built prior to 11/06	2
64314-000	25	Rear Shackle Plate	4
64159-000	26	Thrust Washer, Only for vehicles built prior to 11/06	4
n/a	27	M20 150 mm Hex Bolt**	4
n/a	28	M20 Hardened Washer**	8
n/a	29	M20 Locknut**	4

NOTE:

* Item included in assembly only, part not sold separately.

** Not supplied by Hendrickson, used for reference only. Refer to OEM (vehicle manufacturer) for more information.

Hendrickson is not responsible for components supplied by vehicle manufacturer. For assistance with maintenance and rebuild instructions on these components see vehicle manufacturer.

*** Hendrickson supplies different tie rod assemblies and each type may take a different replacement tie rod end kit to service. Prior to ordering, find the OEM Part Number on the tie rod tube, reference Hendrickson Publication No. SEU-0223 or contact Hendrickson Tech Services for corresponding kit numbers: 1-866-755-5968.

OEM Part Number	Item No.	Description	Qty.
n/a		60952-XXX Axle Assembly, Includes Item Nos. 30-55, Contact Hendrickson Tech Services for Part No.	1
64905-004	30	Axle & Kingpin Assembly, 6.5", 8.5" Ride Height	1
n/a		Left Hand Lower Steering Knuckle Assembly *	1
58900-035	31	Left Hand Lower Steering Knuckle Assembly - 150 Ackermann Air Brake	1
58900-033	31	Left Hand Lower Steering Knuckle Assembly - 200 Ackermann Air Brake	1
58900-031	31	Left Hand Lower Steering Knuckle Assembly - 250 Ackermann Air Brake	1
58900-055	31	Left Hand Lower Steering Knuckle Assembly - 150 Ackermann Hydraulic Brake	1
58900-053	31	Left Hand Lower Steering Knuckle Assembly - 200 Ackermann Hydraulic Brake	1
58900-051	31	Left Hand Lower Steering Knuckle Assembly - 250 Ackermann Hydraulic Brake	1
58900-036	32	Right Hand Lower Steering Knuckle Assembly - 150 Ackermann Air Brake	1
58900-034	32	Right Hand Lower Steering Knuckle Assembly - 200 Ackermann Air Brake	1
58900-032	32	Right Hand Lower Steering Knuckle Assembly - 250 Ackermann Air Brake	1
58900-056	32	Right Hand Lower Steering Knuckle Assembly - 150 Ackermann Hydraulic Brake	1
58900-054	32	Right Hand Lower Steering Knuckle Assembly - 200 Ackermann Hydraulic Brake	1
58900-052	32	Right Hand Lower Steering Knuckle Assembly - 250 Ackermann Hydraulic Brake	1
60903-016	33	Left Hand Upper Steering Knuckle Assembly	1
60904-002	34	Right Hand Upper Steering Knuckle Assembly	1
60961-040		Kingpin Bushing and Bearing Service Kit, Axle Set, Includes Kit Nos. 60961-009 & 60961-039	
60961-009		Left Hand Kingpin Bushing w/Composite Thrust Bearing Service Kit, Includes Item Nos. 35-38, 40-42 & Loctite	
60961-039		Right Hand Kingpin Bushing w/Roller Thrust Bearing Service Kit, Includes Item Nos. 35-37, 39-42 & Loctite	
59156-000	35	Grease Cap Assembly	4
58937-000	36	Retaining Ring	4
58909-000	37	Kingpin Bushing	4
60961-043		Thrust Bearing Service Kit, Axle Set, Includes Kit Nos. 60961-041 & 60961-042	
60961-041		Left Hand Composite Thrust Bearing Service Kit, Includes Item Nos. 38, 40-42, Loctite	
60961-042		Right Hand Roller Thrust Bearing Service Kit, Includes Item Nos. 39-42, Loctite	
59828-000	38	Left Hand Composite Thrust Bearing	1
64256-000	39	Right Hand Roller Thrust Bearing	1
60259-002	40	Kingpin Shim - 0.047"	2
60259-001	Not Shown	Kingpin Shim - 0.005" (As needed for service)	
58910-001	41	Kingpin Seal, Replaces 58910-000	4
60236-001	42	5/8"-11 UNC Socket Head Cap Screw	4
60937-000	Not Shown	Loctite (Red) Compound Tube	1
64246-000	43	ABS Sensor Sleeve 2	

NOTE:

* Item included in assembly only, part not sold separately.

** Not supplied by Hendrickson, used for reference only. Refer to OEM (vehicle manufacturer) for more information.

Hendrickson is not responsible for components supplied by vehicle manufacturer. For assistance with maintenance and rebuild instructions on these components see vehicle manufacturer.

*** Hendrickson supplies different tie rod assemblies and each type may take a different replacement tie rod end kit to service. Prior to ordering, find the OEM Part Number on the tie rod tube, reference Hendrickson Publication No. SEU-0223 or contact Hendrickson Tech Services for corresponding kit numbers: 1-866-755-5968.

OEM Part Number	Item No.	Description	Qty.
66699-003	44	Tie Rod Assembly, 10K, 5.36 Drop, Includes Item Nos. 45-49 - 200 Ackermann Replaces 59948-005 ***	1
66699-001	44	Tie Rod Assembly, 10K, 5.36 Drop, Includes Item Nos. 45-49 - 250 Ackermann Replaces 59948-006 ***	1
n/a	45	7/8" Castle Nut 2 *	
60961-139		Tie Rod End Service Kit, Axle Set, Replaces 60961-012, Includes Kit Nos. 60961-137 & -138 ***	
60961-137		Left Hand Tie Rod End Service Kit, Replaces 60961-029, Includes Item Nos. 46, 48-49 ***	
60961-138		Right Hand Tie Rod End Service Kit, Replaces 60961-030, Includes Item Nos. 47-49 ***	
66645-001	46	Left Hand Tie Rod End, Replaces 64004-001 ***	1
66645-002	47	Right Hand Tie Rod End, Replaces 64004-002 ***	1
22962-007	48	7/8" Flat Washer	2
17800-004	49	Tie Rod Nut Cotter Pin	2
60961-069		Stop Bolt Service Kit, One Side, Includes Item Nos. 50-51	
60238-001	50	1/2"-13 UNC Square Head Bolt	2
60240-000	51	1/2"-13 UNC Hex Jam Nut	2
59952-003	52	Top Axle Wrap	2
64722-003	53	Bottom Axle Wrap	2
60961-015		Top/Bottom Axle Wrap Liner Service Kit, One Side, Includes Item Nos. 54-55	
60508-000	54	Top Axle Wrap Liner	2
59845-000	55	Bottom Axle Wrap Liner	2
60961-051		Clamp Group Service Kit, One Side, Includes Item Nos. 56-58 - 6.5" Ride Height	
60961-052		Clamp Group Service Kit, One Side, Includes Item Nos. 56-58 - 8.5" Ride Height	
21867-044	56	3/4"-16 UNF Hex bolt - 6.5" Ride Height - 10.0"	8
21867-045	56	3/4"-16 UNF Hex bolt - 8.5" Ride Height - 12.0"	8
22962-001	57	3/4" Flat Washer	8
17700-035	58	3/4"-16 UNF-2B Nylon Locknut	8
18831-021	Not Shown	Dowel Pin, 8.5" Ride Height - 2.0"	2
64516-001	59	Top Pad - Left Hand	1
64516-002	59	Top Pad - Right Hand	1
64536-010	60	Front Axle Spacer - Left Hand 6.5" Ride Height	1
64536-060	60	Front Axle Spacer - Left Hand 8.5" Ride Height	1
64536-050	Not Shown	Front Axle Spacer - Right Hand 8.5" Ride Height	1

NOTE:

* Item included in assembly only, part not sold separately.

** Not supplied by Hendrickson, used for reference only. Refer to OEM (vehicle manufacturer) for more information.

Hendrickson is not responsible for components supplied by vehicle manufacturer. For assistance with maintenance and rebuild instructions on these components see vehicle manufacturer.

*** Hendrickson supplies different tie rod assemblies and each type may take a different replacement tie rod end kit to service. Prior to ordering, find the OEM Part Number on the tie rod tube, reference Hendrickson Publication No. SEU-0223 or contact Hendrickson Tech Services for corresponding kit numbers: 1-866-755-5968.

SP-173 C COMFORT AIR

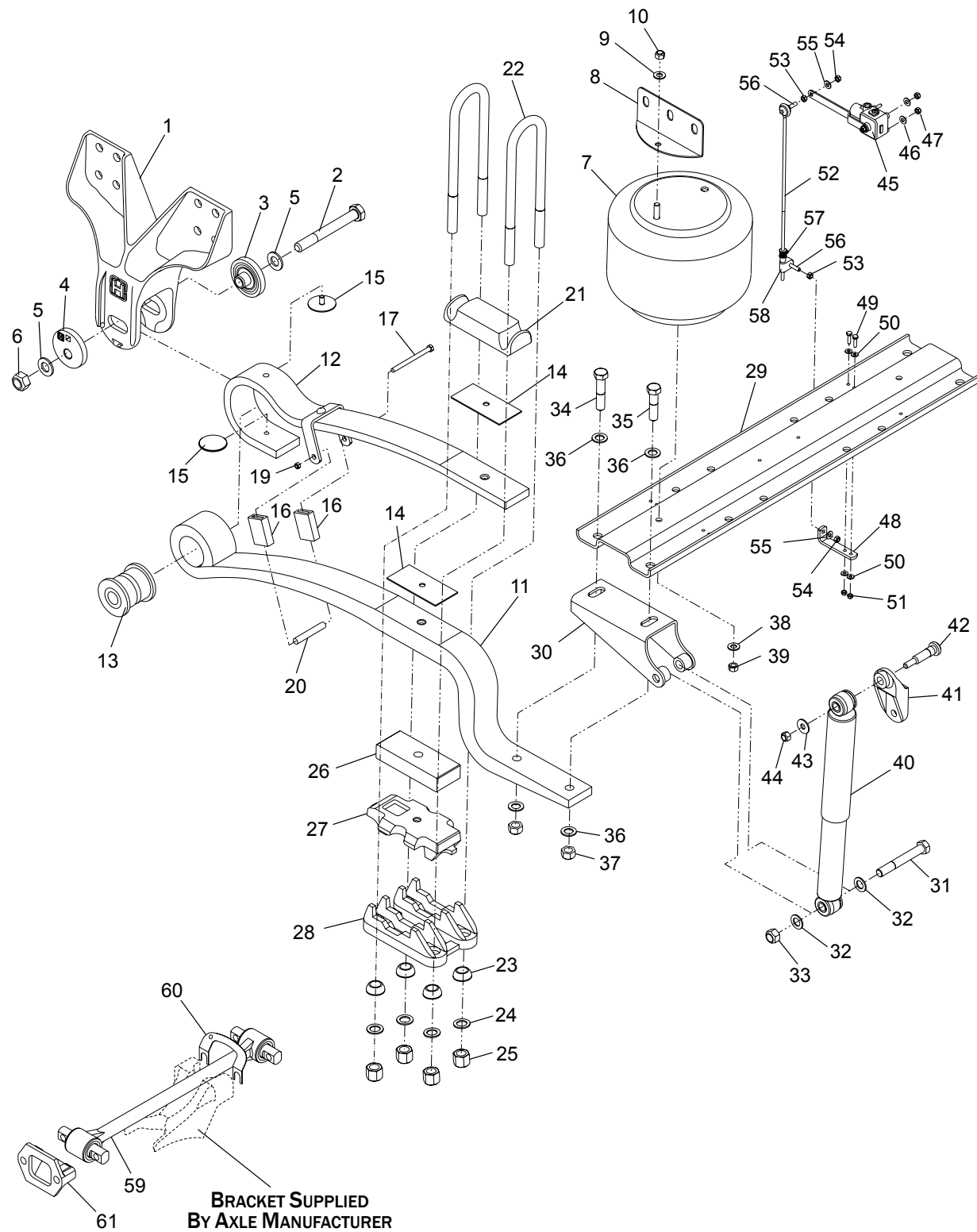


Table 6-41: SP-173 C Comfort Air

OEM Part Number	Item No.	Description	Qty.
60784-000	1	Frame Hanger	2
60632-001		QUIK-ALIGN® Service Kit, Axle Set, Includes Item Nos. 2-6	
34013-103		Pivot Bushing Service Kit, One Side, Includes Item Nos. 2, 5-6, 13, 15	
64107-000	2	1"-8 UNC Bolt 7.50"	2
64633-000	3	QUIK-ALIGN Concentric Collar	3
64632-000	4	QUIK-ALIGN Eccentric Collar	1
22962-035	5	1" Hardened Washer	4
64108-000	6	1"-8 UNC Locknut	2
60925-002		Air Spring Assembly, Includes Item Nos. 7-10	2
60929-002		Air Spring Assembly Front Engine, Includes Item Nos. 7-10	2
n/a	7	Air Spring *	2
57096-002	8	Air Spring Bracket	2
22962-014	9	1/2" Flat Washer	2
17700-010	10	1/2"-13UNC Nylocknut	2
60779-000		Main Support Assembly, Includes Item Nos. 11-20	2
n/a	11	Main Support Member *	2
n/a	12	Secondary Leaf *	2
58648-000	13	Pivot Bushing	2
37674-051	14	Liner	4
64817-000	15	Puck	4
49175-026		Spring Clip Fastener Service Kit, Axle Set, Includes Item Nos.16-19	
64272-000	16	Spring Clip Sleeve	4
37042-002	17	7/16"-14 UNC Bolt	2
22962-027	18	7/16" Washer (Not Shown)	
17700-007	19	7/16"-14 UNC Nut	2
n/a	20	Clip Bolt Spacer *	2
56805-000	21	Top Pad (All except 15,000 lb. capacity)	2
57724-000	21	Top Pad (15,000 lb. capacity)	2
48718-		U-bolt Service Kit, Axle Set - 7/8" Specify Length, Includes Item Nos. 22-25	
48718-104		U-bolt Service Kit, Axle Set - 3/4"-15,000 lb. capacity, Includes Item Nos. 22, 24-25	
47417-	22	7/8"-14 UNF U-bolt - Specify Length	4
49684-014		3/4" 26 UNF U-bolt - 12.5" 15,000 lbs.Capacity	4
48574-000	23	Spherical Washer	8
22962-002	24	7/8" Hardened Flat Washer	8
22962-001		3/4" Hardened Flat Washer (15,000 lb. Capacity)	8
50765-000	25	7/8" 14UNF U-Bolt Locknut	8
49685-000		3/4" 16UNF U-Bolt Locknut (15,000 lb. Capacity)	8
48531-014	26	Spacer 1.5" (As Required)	2
57022-010	27	Spring Seat - 4.5° Pinion Angle Left Hand/Right Hand, Meritor RS15-120	2

NOTE:

* Item included in assembly only, part not sold separately.

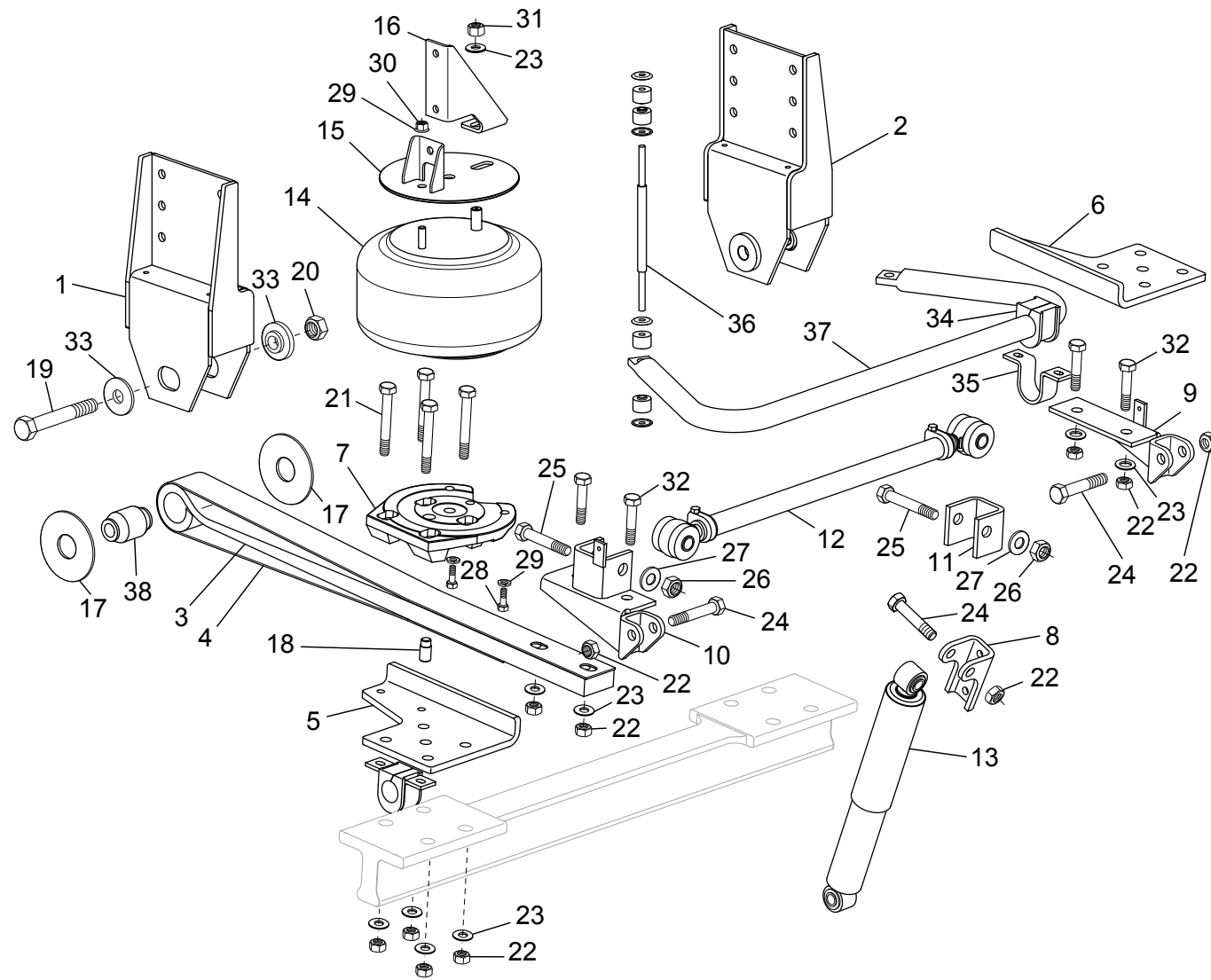
OEM Part Number	Item No.	Description	Qty.
56501-006	27	Spring Seat - 4.5° Pinion Angle Left Hand/Right Hand, Meritor RS21-145, RS23-160	2
56501-019	27	Spring Seat - 0.0° Pinion Angle Left Hand/Right Hand, Meritor RS21-145, RS23-160	2
56501-020	27	Spring Seat - 4.5° Pinion Angle Left Hand/Right Hand, Meritor RS21-145, RS23-160	2
56501-021	27	Spring Seat - 0.0° Pinion Angle Left Hand/Right Hand, Meritor RS21-145, RS23-160	2
56501-020	27	Spring Seat - Negative 4.5° Pinion Angle Left Hand/Right Hand, Meritor RC23-160	2
57024-000	28	Axle Bottom Cap - 2-5.0° Pinion Angle Left Hand/Right Hand, Meritor RS15-120	2
50216-000	28	Axle Bottom Cap - 0-9.5° Pinion Angle Left Hand/Right Hand, Meritor RS21-145, RS23-160	2
50216-000	28	Axle Bottom Cap - Negative 0-9.5° Angle Left Hand/Right Hand, Meritor RC23-160	2
n/a	29	Cross Channel, Contact Hendrickson Tech Services for proper Cross Channel *	1
57356-000		Lower Shock Bracket Assembly, Includes Item Nos. 30-33	2
n/a	30	Lower Shock Bracket *	2
50764-002	31	3/4"-10 UNC Bolt - 5.50"	2
22962-001	32	3/4" Hardened Washer	4
49842-000	33	3/4"-10 UNC Locknut	2
50763-004		Cross Channel Fastener Service Kit, Axle Set, Includes Item Nos. 34-37	
50764-003	34	3/4"-10 UNC Bolt - 3.50"	2
50764-005	35	3/4"-10 UNC Bolt - 3.00"	2
22962-001	36	3/4" Hardened Washer	8
49842-000	37	3/4"-10 UNC Locknut	4
49177-006		Air Spring Fastener Service Kit, Axle Set, Includes Item Nos. 38-39	
22962-014	38	1/2" Hardened Washer	2
17700-010	39	1/2"-13 UNC Nylocknut	2
60998-001	40	Shock Absorber	2
57322-002		Upper Shock Bracket Assembly, Includes Item Nos. 41-44	2
n/a	41	Upper Shock Bracket *	2
50368-000	42	1/2"-13 UNC Serrated Shank Bolt	2
22962-031	43	1/2" Hardened Washer	2
49846-000	44	1/2"-13 UNC Locknut	2
59013-000		Height Control Valve Service Kit, Axle Set, Includes Item Nos. 45-47	
n/a	45	Height Control Valve *	1
n/a	46	1/4" Hardened Washer *	2
n/a	47	1/4"-20 UNC Locknut *	2
57430-000		HCV Linkage Lower Bracket Service Kit, Includes Item Nos. 48-51 - All Except Rear Engine	
57430-003		HCV Linkage Lower Bracket Service Kit, Includes Item Nos. 48-51 - Rear Engine Only	
56789-000	48	HCV Linkage Bracket	1
58367-000		HCV Linkage Bracket (Rear Engine)	
56935-002	49	1/4"-20 UNC Bolt - 1.00"	2
22962-028	50	1/4" Hardened Washer	4

NOTE:
* Item included in assembly only, part not sold separately.

OEM Part Number	Item No.	Description	Qty.
49983-000	51	1/4"-20 UNC Locknut	2
58994-		Height Control Valve Linkage Assembly, Specify Length, Includes Item Nos. 52-58	1
n/a	52	HCV Linkage Rod *	1
n/a	53	5/16"-18 UNC Jam Nut *	2
n/a	54	5/16"-18 UNC Locknut *	2
n/a	55	5/16" Hardened Washer *	2
n/a	56	5/16"-18 UNC Stud *	2
n/a	57	Valve Arm Clamp *	1
n/a	58	Adjustable Valve Arm Joint *	1
62000-	59	Transverse Torque Rod Assembly, Specify Length	1
49689-000	60	Torque Rod Shim	As Req.
22186-000	61	Transverse Torque Rod Frame Bracket	1

NOTE:
* Item included in assembly only, part not sold separately.

NEWAY SUSPENSIONS



AS SERIES

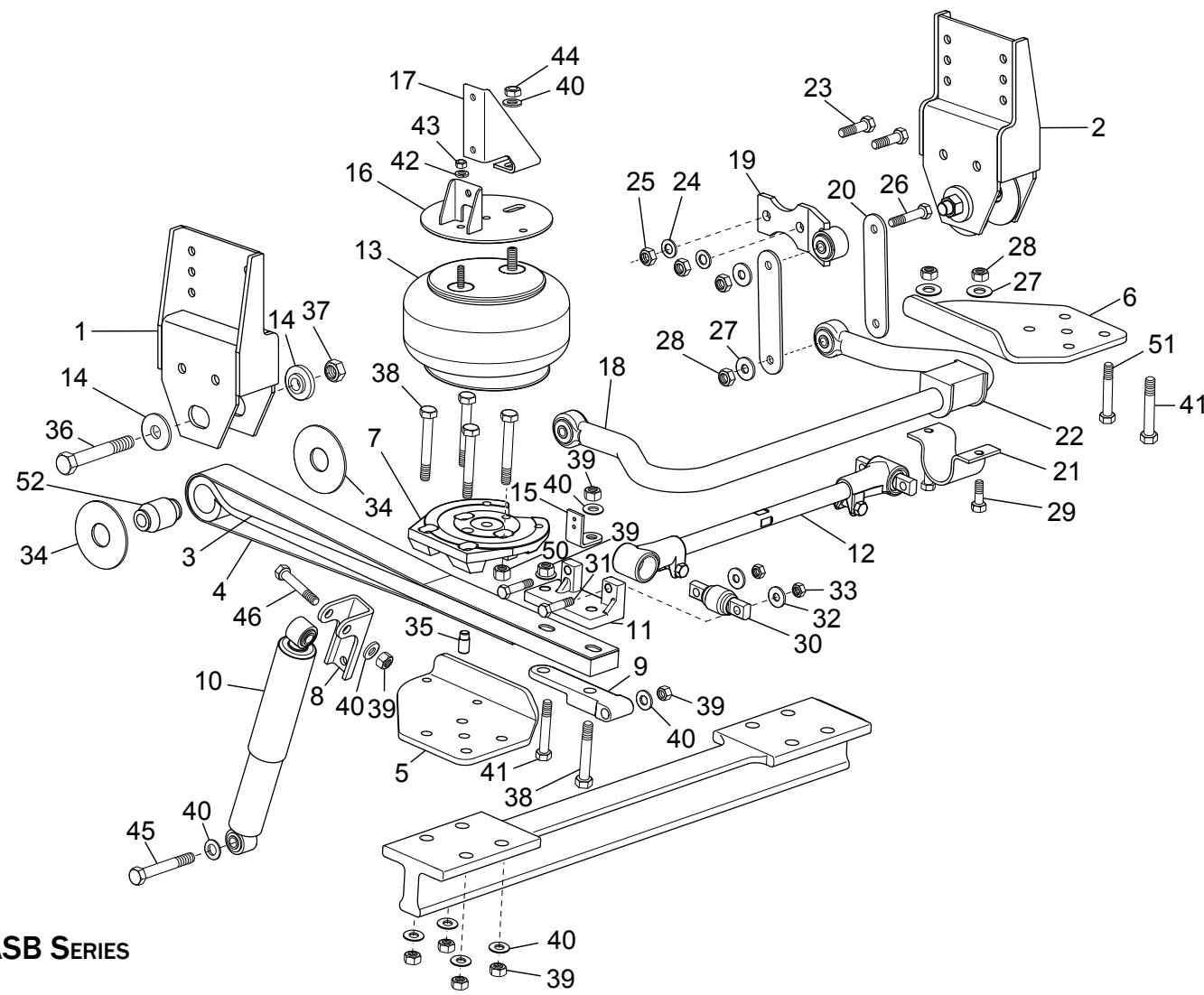
Table 6-42: Neway AS Series Suspension

OEM Part Number	Item No.	Description	Qty.
*	1	Bracket Frame Adjustable Painted	1
*	2	Bracket Frame Fixed Painted	1
905 16 696	3	Straight Spring Beam Assembly	2
900 45 226	4	Strap Restraining	2
n/a	5	Plate Spacer LH Painted *	1
n/a	6	Plate Spacer RH Painted *	1

* Refer to the chassis builder specifications to properly identify the Neway OEM Part Number for this component. A suspension serial tag denotes the Neway kit number that will provide the individual component number needed.

OEM Part Number	Item No.	Description	Qty.
900 33 845	7	Plate Air Spring Mounting	2
900 18 542	8	Bracket Shock Upper Painted	2
905 20 673	9	Bracket Shock RH	1
905 20 672	10	Bracket Control Arm	1
900 33 472	11	Bracket	1
900 45 385	12	Track Bar Double Adjustable	1
n/a	13	Shock Absorber *	2
n/a	14	Spring Air *	2
905 31 273	15	Plate Air Spring Mounting	2
900 23 131	16	Brace Angle (where applicable)	2
900 36 192	17	Shim Pivot	4
900 45 233	18	Pin	2
939 00 174	19	Bolt Hex 1" x 8 x 6-1/2" Grade 5	2
934 00 500	20	Nut Hex Lock 1" x 8 Grade B	2
930 03 635	21	Bolt Hex 3/4" - 10 x 5" Grade 8	8
934 00 494	22	Nut Hex Lock 3/4" - 10 Grade C	16
936 00 156	23	Washer Flat Narrow 3/4"	14
930 03 603	24	Bolt Hex 3/4" - 10 x 3-3/4" Grade 5	4
930 03 831	25	Bolt Hex 7/8" - 9 x 4-1/2" Grade 5	2
934 00 496	26	Nut Hex Lock 7/8" - 9, Grade B	2
936 00 162	27	Washer Flat Narrow 7/8"	4
930 02 901	28	Bolt Hex 1/2" - 13 x 1-1/4" Grade 5	4
936 00 072	29	Washer Lock 1/2"	6
934 00 136	30	Nut Hex 1/2" - 13 Grade B	2
934 00 417	31	Nut Hex Lock Thin 3/4" - 16 Grade A	2
930 03 585	32	Bolt Hex 3/4" - 10 x 3" Grade B	4
900 08 126	33	Alignment Block With Rust INHB	2
900 08 194	34	Bushing	2
900 25 497	35	Bracket	2
905 45 761	36	Link Assembly	2
900 45 212	37	Bar Stabilizer	1
900 08 125	38	Bushing	2

* Refer to the chassis builder specifications to properly identify the Neway OEM Part Number for this component. A suspension serial tag denotes the Neway kit number that will provide the individual component number needed.



ASB SERIES

Table 6-43: Neway ASB Series Suspension

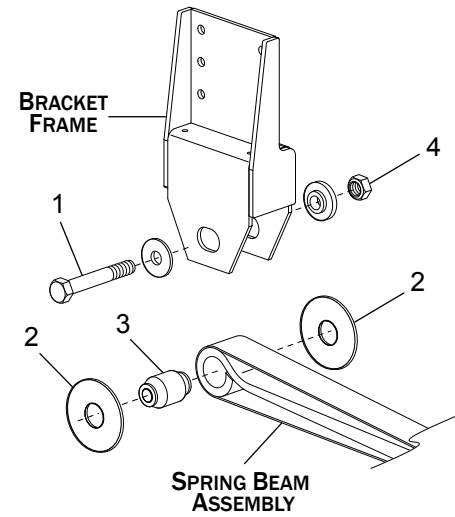
OEM Part Number	Item No.	Description	Qty.
*	1	Bracket Frame Adjust, Painted	1
*	2	Bracket Frame Fixed, Painted	1
n/a	3	Bent or Straight Spring Beam Assembly *	2
n/a	4	Strap *	2
n/a	5	Plate Bent LH Painted *	1
n/a	6	Plate Bent RH Painted *	1
900 33 845	7	Plate Air Spring Mounting	2
900 18 542	8	Bracket Upper Shock Painted	2
M00 18 038	9	Shock Bracket Lower (Machined Painted)	2
n/a	10	Shock Absorber *	2
M00 18 041	11	Bracket Track Rod	1
905 47 903	12	Track Rod Assembly Adjustable	1

* Refer to the chassis builder specifications to properly identify the Neway OEM Part Number for this component. A suspension serial tag denotes the Neway kit number that will provide the individual component number needed.

OEM Part Number	Item No.	Description	Qty.
n/a	13	Air Spring Assembly *	2
n/a	14	Alignment Block *	2
900 26 187	15	Tab Bent	2
905 31 273	16	ASMP Upper Assembly Painted	2
900 23 131	17	Brace Painted	2
905 06 028	18	Sway Bar Assembly	1
905 21 624	19	Link Assembly With Bushing	2
900 34 436	20	Link Plate Painted	4
900 26 040	21	Bushing Clamp	2
900 08 240	22	Bushing	2
930 03 575	23	Bolt Hex 3/4" - 10 x 2.5" Grade 8	4
936 00 156	24	Washer Flat Narrow 3/4"	4
934 00 494	25	Nut Hex Lock 3/4" - 10 Grade C	4
930 03 377	26	Bolt Hex 5/8" - 11 x 3-1/4" Grade 8	4
936 00 150	27	Washer Flat 5/8"	8
934 00 490	28	Nut Hex Lock 5/8" - 11 Grade C	8
930 03 347	29	Bolt Hex 5/8" - 11 x 2" Grade 8	4
900 08 246	30	Bushing	2
930 03 365	31	Bolt Hex 5/8" - 11 x 2-3/4" Grade 8	4
936 00 150	32	Washer Flat 5/8"	4
934 00 490	33	Nut Hex Lock 5/8" - 11 Grade C	4
900 36 192	34	Shim Pivot	4
900 45 233	35	Pin	2
930 04 313	36	Bolt Hex 1" - 8 x 6-1/2" Grade 8	2
934 00 502	37	Nut Hex Lock 1" - 8 Grade C	2
930 03 629	38	Bolt Hex 3/4" - 10 x 4-3/4" Grade 8	9
934 00 494	39	Nut Hex Lock 3/4" - 10 Grade C	16
936 00 156	40	Washer Flat Narrow 3/4"	20
930 03 617	41	Bolt Hex 3/4" - 10 x 4-1/4" Grade 8	2
936 00 072	42	Washer Lock 1/2"	2
934 00 136	43	Nut Hex 1/2" - 13 Grade B	2
934 00 417	44	Nut Hex Lock Thin 3/4" - 16 Grade A	2
930 03 647	45	Bolt Hex 3/4" - 10 x 5-1/2" Grade 8	2
930 03 605	46	Bolt Hex 3/4" - 10 x 3-3/4" Grade 8	2
934 00 492	50	Nut Hex 3/4" - 10 Grade B	2
930 03 593	51	Bolt Hex 3/4" - 10 x 3-1/4" Grade 8	1
900 08 125	52	Bushing	2

* Refer to the chassis builder specifications to properly identify the Neway OEM Part Number for this component. A suspension serial tag denotes the Neway kit number that will provide the individual component number needed.

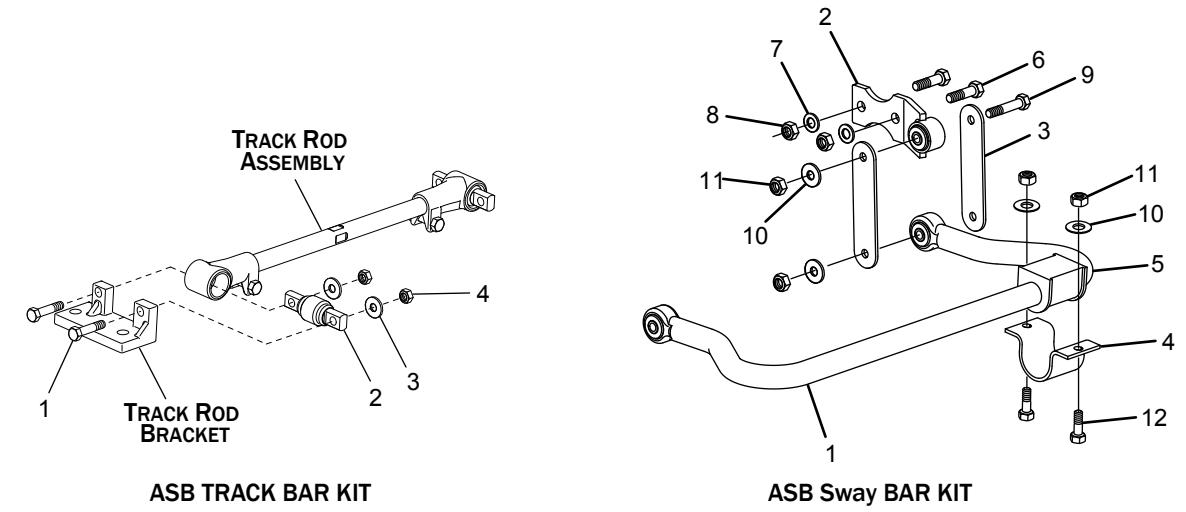
One (1) SRK required per axle.
 Use Grade 8 and C hardware for ASB applications.
 To order AS sway bar parts, refer to AS Series items 34 - 37.



AS SERVICE REBUILD KITS (SRKs)

Table 6-44: Neway AS Series – Service Rebuild Kits (SRKs)

OEM Part Number	Item No.	Description	Qty.
AS FRONT PIVOT CONNECTION, SRK-502 (PN: 481 00 366)			
939 00 174	1	Bolt Hex 1" - 8 x 6-1/2" Grade 5	2
900 36 192	2	Shim Pivot	4
900 08 125	3	Bushing	2
934 00 500	4	Nut Hex Lock 1" - 8 Grade B	2



ASB SERVICE REBUILD KITS (SRKs)

Table 6-45: Neway ASB Series – Service Rebuild Kits (SRKs)

OEM Part Number	Item No.	Description	Qty.
ASB TRACK BAR KIT, SRK-617 (PN: 481 00 483)			
930 03 365	1	Bolt Hex 5/8" - 11 x 2-3/4" Grade 8	2
900 08 246	2	Bushing	2
936 00 150	3	Washer Flat 5/8"	2
934 00 490	4	Nut Hex Lock 5/8" - 11 Grade C	2
ASB SWAY BAR KIT, SRK-616 (PN: 481 00 480)			
905 06 028	1	Sway Bar Assembly	1
905 21 624	2	Link Assembly With Bushing	2
900 34 436	3	Link Plate Painted	4
900 26 040	4	Bushing Clamp	2
900 08 240	5	Bushing	2
930 03 575	6	Bolt Hex 3/4" - 10 x 2-1/2" Grade 8	4
936 00 156	7	Washer Flat Narrow 3/4"	4
934 00 494	8	Nut Hex Lock 3/4" - 10 Grade C	4
930 03 377	9	Bolt Hex 5/8" - 11 x 3-1/4" Grade 8	4
936 00 150	10	Washer Flat 5/8"	8
934 00 490	11	Nut Hex Lock 5/8" - 11 Grade C	8
930 03 347	12	Bolt Hex 5/8" - 11 x 2" Grade 8	4



*For information, updates, or corrections,
please contact us at TRPBus@TRPParts.com*

*No part of this marketing material may be
reproduced in any manner without written
permission from TRP® North America.*

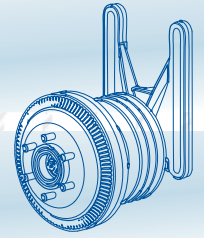
TRP® North America

750 Houser Way N.
Renton, WA 98057

www.trpparts.com



Parts for all brands of buses.



7

BUS PARTS[®]

ENGINE KITS

*Proven, reliable and
always innovative.*

TRP[®] offers reliable aftermarket products that are designed and tested to exceed customers' expectations regardless of the bus make, model or age.



RADIATORS • CHARGE AIR COOLERS • FANS •
FAN DRIVES • ENGINE KITS



Tested. Reliable. Guaranteed.

Engine Kits & Related Parts

Choosing the right replacement part or service for your vehicle—whether you own one, or a fleet—is one of the most important decisions you can make for your business. And, with tested TRP® parts it's an easy decision.

Regardless of the make you drive, TRP® quality replacement parts are engineered to fit your truck, trailer or bus. Choose the parts that give you the best value for your business. Check them out at an approved TRP® retailer near you.

The cross reference information in this catalog is based upon data provided by several industry sources and our partners. While every attempt is made to ensure the information presented is accurate, we bear no liability due to incorrect or incomplete information.

Product Availability

Due to export restrictions and market demands, not all products are always available in every location. Check for availability in your area with your local TRP® Distributor.

No part of this marketing material may be reproduced in any manner without written permission from TRP® North America.

CONTENTS

RADIATORS

<u>Radiators</u>	7-5
Radiators with Transmission Oil Cooler	7-7
Radiators without Transmission Oil Cooler	7-8

BUS APPLICATIONS FOR RADIATORS

<u>Bus Applications for Radiators</u>	7-9
Freightliner	7-9
International/IC Bus	7-9

CHARGE AIR COOLERS

<u>Charge Air Coolers</u>	7-13
Charge Air Coolers	7-13

FAN DRIVES

<u>Fan Drives from BorgWarner</u>	7-14
Fan Drives from BorgWarner	7-14
Fan Drive Maintenance Kits from BorgWarner	7-14
<u>Fan Drives from Horton</u>	7-15
DM Avantage	7-15
DriveMaster Pneumatic	7-15
HT/S Pneumatic	7-16
HT650 Pneumatic	7-17
MagForce Electromagnetic	7-17
Fan Drives from Horton - Electronic Direct Sensing	
Viscous Fan Drive	7-18

TRP® North America

750 Houser Way N.
Renton, WA 98057

www.trpparts.com

DM Avantage	7-15
DriveMaster Pneumatic	7-15
DM Avantage	7-15
MagForce Electromagnetic	7-15

FANS

<u>Fans</u>	7-19
<u>Fans & Fan Assembly Pieces</u>	7-19
Fans from BorgWarner - 7 Blade	7-19
Fans from BorgWarner - 8 Blade	7-19
Fans from BorgWarner - 9 Blade, CW	7-20
Fans from BorgWarner - 9 Blade, CCW	7-20
Fans from BorgWarner - 10 Blade	7-21
Fans from BorgWarner - 11 Blade	7-21
Fan Mounting Kits from BorgWarner	7-21
Valves from BorgWarner	7-21

BUS APPLICATIONS

FOR FANS

<u>Bus Applications for Fans</u>	7-22
Blue Bird OE	7-22
Blue Bird Aftermarket	7-22
MCI	7-22
Navistar	7-22
Neopart	7-23
New Flyer	7-23
NOVA	7-23
Orion	7-23
Prevost	7-23
Thomas Built	7-23

ENGINE KITS (FOR NAVISTAR DT466ABC)

<u>Navistar Basic Engine Identification</u>	7-24
<u>In-Frame Kits for DT466ABC</u>	7-24
<u>Overhaul Kits for DT466ABC</u>	7-25
<u>Cylinder Components for DT466ABC</u>	7-25
For ESN 75000 - 1st New Generation	7-25

For ESN 75000 - 1st New Generation, All	7-26
For ESN 75000 - 1st New Generation, with 4-Ring Piston	7-26

Cylinder Head Components for DT466ABC

Seats	7-26
Valves	7-26
Valves & Seats	7-27

Engine Bearings for DT466ABC

Cam Bearing Sets	7-27
Connecting Rod Bearings ESN 439618 (1.195"W)	7-27
Connecting Rod Bearings ESN 439619 (1.255"W)	7-27
Connecting Rod Bushings	7-27
Idler Bearings	7-27
Main Bearings ESN 439618 (1.220"W)	7-27
Main Bearings ESN 439619 (1.293"W)	7-27

Crankshafts & Seals for DT466ABC

Crankshafts	7-28
Seals	7-28

Camshafts & Lifters for DT466ABC

Camshafts	7-28
Lifters	7-28

Gaskets for DT466ABC

Gasket Listings	7-29
Gasket Sets	7-29

Oil Coolers & Pumps for DT466ABC

Coolers	7-30
Pumps	7-30

Water System Components for DT466ABC

Water Thermostats	7-30
Pumps	7-30

In-Frame Kits for DT466E

Cylinder Components for DT466E

For ESN = 980820 - 1194038, 175-210ST	7-31
---	------

For ESN = 981120 - 1194038, 250-275 HP All 7-31

For ESN < 1126948 210HT & 230-250 HP All 7-31

For ESN = 1126949 - 1194038, 230-250 HP All 7-32

For ESN > 1194039, 175-215 HP All 7-32

For ESN > 1194039, 230-250 HP All 7-32

For ESN > 1194039, 250-275 HP All 7-33

Cylinder Head Components for DT466E - ESN 1194038 7-33

 Seats 7-33

 Valves 7-33

 Valves & Seats 7-34

Cylinder Head Components for DT466E - ESN 1194039 - 2000000 7-34

 Seats 7-34

 Valves 7-34

 Seats & Valves 7-34

Engine Bearings for DT466E 7-35

 Cam Bearings 7-35

 Connecting Rod Bearings ESN 1194038 7-35

 Connecting Rod Bearings ESN 1194039 7-35

 Connecting Rod Bushings 7-35

 Main Bearings ESN 1194038 7-35

 Main Bearings ESN 1194039 7-35

 Main Bearings ESN 1194040 7-35

 Main Bearings ESN 2000000 - 3000000 7-36

Crankshafts & Seals for DT466E 7-36

 Crankshafts 7-36

 Seals 7-36

Gaskets for DT466E 7-36

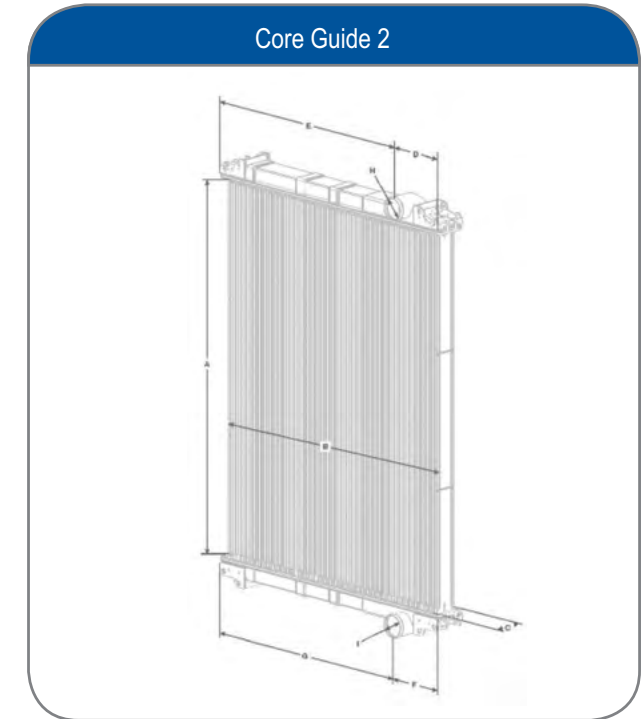
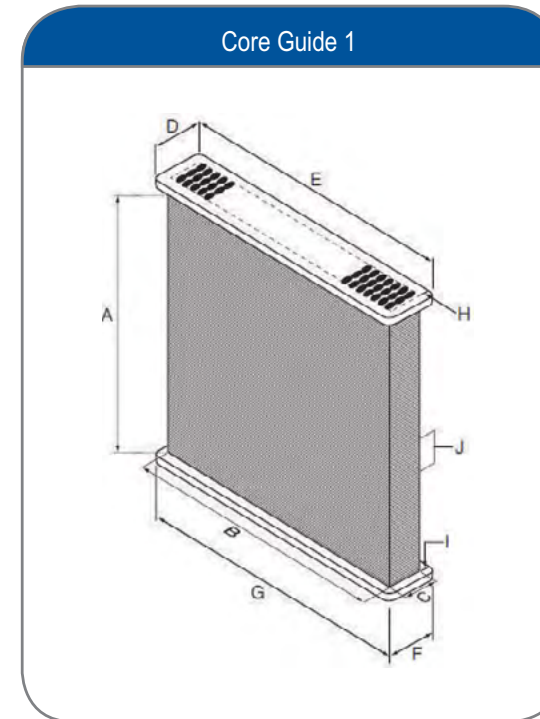
 Gasket Sets 7-36

Water System Components for DT466E 7-37

 Water Thermostat Kits 7-37

 Water Pumps 7-37

RADIATORS



Radiators Design Improvements

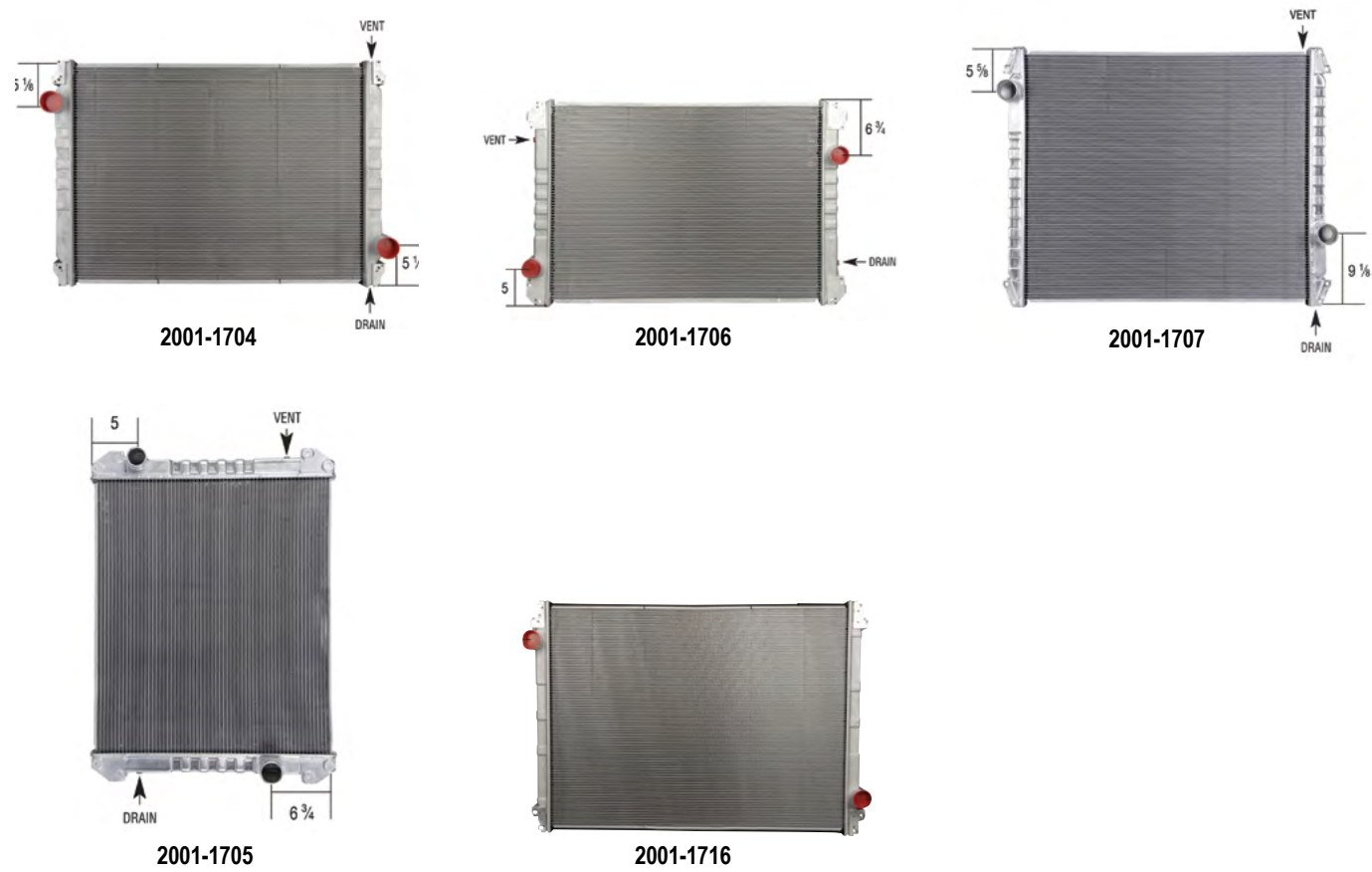
- Clevis Pins on Freightliner Models: Allowing The Core to Properly Expand within the Frame
- Stress-Relief Cuts: Reducing Stress to the Headers
- Cancelled End Tubes: Preventing Corner Leaks
- OE-Style Clevis Pins Included (When Required) to Allow for Thermal Expansion and Movement of the Radiator within the Frame
- All-Brazed Construction Ensures Proper Tank-to-Header Bonding
- Precisely Tooled Connections for Optimal Strength
- Siderail "Stress Cuts" Allowing Maximum Thermal Expansion
- Rubber Insulator Designed to Fit Exactly in the Original Frame
- Siderail and Out Tubes Designed to Avoid Premature Failure
- Re-Designed Corner Brackets to Increase Overall Unit Durability and Improve Ease of Installation I - Outlet connection diameter

Measurement Guide for Radiators

- A - Height of Radiator/Core
- B - Width of Radiator/Core
- C - Radiator/Core Thickness
- D - Inlet Connection Position Measurement from Top RH Corner
- E - Inlet Connection Position Measurement from Top LH Corner
- F - Outlet Connection Position Measurement from Bottom RH Corner
- G - Outlet Connection Position Measurement from Bottom LH Corner
- H - Inlet Connection Diameter/Top Header Offset
- I - Outlet Connection Diameter/Bottom Header Offset
- J - Number of Fins Per Inch

Additional information needed upon ordering

- Bolted Core**
- 1 - Number of Bolt Holes
 - 2 - Shape of Headers
 - 3 - Material Gauge of Headers
 - 4 - Fin Material: Copper, Brass or Steel
- Soldered Core**
- 1 - Radius of Headers
 - 2 - Drop Seam (formed header)
 - 3 - Material Gauge of Headers
 - 4 - Copper, Brass or Steel Fin Material



RADIATORS

Table 7-1: Radiators

Part Number	Description	Direction of flow	Dim. A	Dim. B	Dim. C	Application	OE PN
2001-1704	Radiator 36-1/8" x 27-1/2" x 2-1/4" Core Dimension - Transmission Oil Cooler n/a	Downflow	27-1/2"	2-1/4"		1993-2007 Freightliner FLD120/L-Line (Louisville)	BHTC1673
2001-1706	Radiator 34-5/8" x 24-1/2" x 2-1/4" Core Dimension - Transmission Oil Cooler n/a	Downflow	24-1/2"	2-1/4"		1993-2007 Freightliner FL80/COLUMBIA 112	BHTA4568
2001-1707	Radiator 36" x 31-3/4" x 1-7/8" Core Dimension - Transmission Oil Cooler n/a	Downflow	31-3/4"	1-7/8"		1994-2007 Freightliner FLD112/M2 106	BHTA6724
2001-1705	Radiator 28-3/4" x 25" x 2-3/8" Core Dimension - without Transmission Oil Cooler - without Power Take-Off	Downflow	25"	2-3/8"		1992-2004 Freightliner FLD120/FL70	BHTB7596
2001-1716	Radiator 41-3/4" x 31-1/2" x 2-1/4" Core Dimension - Inlet Connection 5-5/8" from top left corner, Outlet Connection 5-5/8" from bottom right corner	Downflow	31-1/2"	2-1/4"		1990-2007 Freightliner FLD120/COLUMBIA 120	BHTD0635



Part Number	Description	Direction of flow	Dim. A	Dim. B	Dim. C	Application	OE PN
-------------	-------------	-------------------	--------	--------	--------	-------------	-------

RADIATORS WITH TRANSMISSION OIL COOLER

2006-3501	Radiator 31-1/8" x 12-3/4" x 2-1/4" Core Dimension - with Transmission Oil Cooler: 18" engine/fan side	Downflow		12-3/4"	2-1/4"	1990-1997 International/IC Bus 4700/4900 SERIES	1696921C1
2006-3505A	Radiator 31-1/8" x 13-1/8" x 2-1/4" Core Dimension - with Transmission Oil Cooler: 18" engine/fan side	Downflow		13-1/8"	2-1/4"	1995-2004 International/IC Bus 3800	2502718C1
2006-3517	Radiator 31-1/8" x 26-1/2" x 1-7/8" Core Dimension - with Transmission Oil Cooler: 18" engine/fan side	Downflow		26-1/2"	1-7/8"	1981-2001 International/IC Bus 1954/3800	493367C4
2006-3502	Radiator 30-5/8" x 13-1/8" x 2-1/4" Core Dimension - with Transmission Oil Cooler: 18" grill side	Downflow		13-1/8"	2-1/4"	1986-2004 International/IC Bus 1853/3800	2026624C91
2006-3507	Radiator 30-5/8" x 13-1/8" x 2-1/4" Core Dimension - with Transmission Oil Cooler: 18" grill side	Downflow		13-1/8"	2-1/4"	1984-2004 International/IC Bus 1953/3800	2505159C91
2006-3508	Radiator 31-1/8" x 12-3/4" x 2-1/4" Core Dimension - with Transmission Oil Cooler: 18" engine/fan side	Downflow		12-3/4"	2-1/4"	1994-2006 International/IC Bus 4700/4200	3527216C91

Part Number	Description	Direction of flow	Dim. A	Dim. B	Dim. C	Application	OE PN
2006-3510	Radiator 31-1/8" x 12-3/4" x 2-1/4" Core Dimension - with Transmission Oil Cooler: 18" grill side	Downflow		12-3/4"	2-1/4"	1990-1997 International/IC Bus 4700/4900 SERIES	1A16913
2006-3511	Radiator 31-1/8" x 12-3/4" x 2-1/4" Core Dimension - with Transmission Oil Cooler: 18" grill side	Downflow		12-3/4"	2-1/4"	1994-2006 International/IC Bus 4700/4200	2004694C91
2006-3512	Radiator 31-1/8" x 12-3/4" x 2-1/4" Core Dimension - with Transmission Oil Cooler: 18" grill side	Downflow		12-3/4"	2-1/4"	1995-1998 International/IC Bus 3800	1697743C2
2001-1714	Radiator 28-3/4" x 25" x 2-3/8" Core Dimension - with Transmission Oil Cooler: 18" engine/ fan side without Power Take-Off/ Crank Hole	Downflow		25"	2-3/8"	1993-2003 FREIGHTLINER FLD120/FL70	A0516909000



RADIATORS WITHOUT TRANSMISSION OIL COOLER

2006-3513	Radiator 31-1/8" x 12-3/4" x 2-1/4" Core Dimension - without Transmission Oil Cooler	Downflow		12-3/4"	2-1/4"	1995-1998 International/IC Bus 3800	203778C91
2006-3506A	Radiator 31-1/8" x 12-3/4" x 2-1/4" Core Dimension - without Transmission Oil Cooler	Downflow		12-3/4"	2-1/4"	1988-2001 International/IC Bus 2375/4900 SERIES	3503905C92
2006-3509	Radiator 31-1/8" x 12-3/4" x 2-1/4" Core Dimension - without Transmission Oil Cooler	Downflow		12-3/4"	2-1/4"	1988-1994 International/IC Bus 1754/4700	1696919C3
2006-3523	Radiator 31-1/8" x 26-1/2" x 2-1/4" Core Dimension - without Transmission Oil Cooler	Downflow		26-1/2"	2-1/4"	1983-2004 International/IC Bus 1954/7400	493359C4

BUS APPLICATIONS FOR RADIATORS

BUS APPLICATIONS FOR RADIATORS

FREIGHTLINER

Table 7-2: Freightliner

Application	Part Number
Freightliner FL80 - Caterpillar 3126B	2001-1705
Freightliner FL80 - Caterpillar 3126B	2001-1704
Freightliner FL80 - Caterpillar 3126B	2001-1705
Freightliner FL80 - Caterpillar 3126B	2001-1714
Freightliner FL80 - Caterpillar 3126B	2001-1705
Freightliner FL80 - Caterpillar 3126B	2001-1706
Freightliner FL80 - Cummins 6C SERIES	2001-1705
Freightliner FL80 - Cummins ISC	2001-1707
Freightliner FL8042S - Caterpillar 3126B	2001-1705
Freightliner FL8042S - Caterpillar 3126B	2001-1706
Freightliner FL8042S - Caterpillar 3126B	2001-1705
Freightliner FL8042S - Caterpillar 3126B	2001-1705
Freightliner FL8042S - Cummins 6C SERIES	2001-1705
Freightliner FL8042S - Cummins 6C SERIES	2001-1706
Freightliner FL8042S - Cummins 6C SERIES	2001-1705
Freightliner FL8042S - Cummins 6C SERIES	2001-1706
Freightliner FL8042S - Cummins 6C SERIES	2001-1705
Freightliner FL8042ST - Caterpillar 3126B	2001-1705
Freightliner FL8042ST - Caterpillar 3126B	2001-1705
Freightliner FL8064S - Caterpillar 3126B	2001-1705
Freightliner FL8064S - Caterpillar 3126B	2001-1705
Freightliner FL8064S - Caterpillar 3126B	2001-1705
Freightliner FL8064S - Caterpillar 3126B	2001-1706
Freightliner FL8064S - Caterpillar 3126B	2001-1705
Freightliner FL8064S - Cummins 6C SERIES	2001-1705

Application	Part Number
Freightliner FL8064S - Cummins 6C SERIES	2001-1705
Freightliner FL8064S - Cummins 6C SERIES	2001-1706
Freightliner FL8064S - Cummins 6C SERIES	2001-1705
Freightliner FL8064S - Cummins 6C SERIES	2001-1706
Freightliner FL8064S - Cummins 6C SERIES	2001-1705
Freightliner FL8064S - Cummins 6C SERIES	2001-1706
Freightliner M2 106 - Caterpillar C7	2001-1707
Freightliner M2 106 - Caterpillar C7	2001-1704
Freightliner M2 106 - Caterpillar C9	2001-1704
Freightliner M2 106 - Caterpillar C9	2001-1704
Freightliner M2 106 - Mercedes- Benz MBE906	2001-1704
Freightliner M2 106 - Mercedes- Benz MBE906	2001-1704
Freightliner M2 106 - Mercedes- Benz MBE906	2001-1707
Freightliner M2 106 - Mercedes- Benz MBE906	2001-1704
Freightliner M2 106 - Mercedes- Benz OM906	2001-1707
Freightliner M2 112 - Mercedes- Benz MBE4000	2001-1716
Freightliner M2 112 - Mercedes- Benz MBE4000	2001-1716

INTERNATIONAL/IC BUS

Table 7-3: International/IC Bus

Application	Part Number
International/IC Bus 3400 - T444E	2006-3507
International/IC Bus 3400 - T444E	2006-3507
International/IC Bus 3400 - T444E	2006-3507
International/IC Bus 3400 - T444E	2006-3507
International/IC Bus 3400 - T444E	2006-3507
International/IC Bus 3600 - T408	2006-3508
International/IC Bus 3600 - DT408	2006-3511

CHARGE AIR COOLERS

Charge Air Coolers are manufactured with a vacuum-brazed all-aluminum construction. The Charge Air Cooler core is assembled from component tubes, fins and internal fins. This assembly is then vacuum-brazed together, forming a single-piece core.

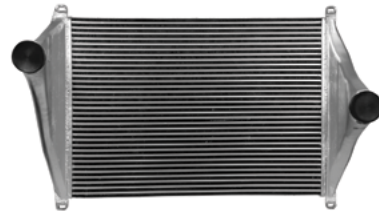
The resulting structure is tremendously strong due to the reinforcement provided by the external and internal fins. After the Charge Air Cooler is assembled and brazed, the end tanks (or manifolds) are welded onto the core.

The welding process provides a means of attachment which is as strong as the aluminum itself. The fins are designed to trip the boundary layer of the air flow over them, thus reducing the thickness of the boundary layer and enhance the transfer of heat.

- All CAC's are built using premium grade materials and are 100% fit-tested.
- Quality brazing process to minimize leakage and increase durability.
- Precisely engineered cast-aluminum tanks for a perfect fit.
- Extruded-tube design minimizes pressure drop; consistently maintains maximum engine operating power.



4401-3504



4401-1709



4401-1715



4401-1701



4401-1705



4401-1712



4406-3502



4401-1714



4406-3501

For Fans See pg. 7-19.



CHARGE AIR COOLERS

Table 7-4: Charge Air Coolers

Part Number	Description	Dimension A	Dimension B	Dimension C	Application	OE PN
4401-3504	Charge Air Cooler 23" x 29-7/8" x 1-5/8" Core Dimension - 3-1/2" Inch Inlet, 3-1/2" Inch Outlet	23"		3-1/2"	1981-2004 International/IC Bus 2275/4300	1646077C1
4401-1709	Charge Air Cooler 36-7/8" x 26-1/4" x 2" Core Dimension - 4" Inch Inlet, 4" Inch Outlet	36-7/8"		2"	1985-2007 WESTERN STAR 4900 SERIES/FLD120	BHTD3521
4401-1715	Charge Air Cooler 36-7/8" x 26-3/8" x 2-1/4" Core Dimension - 4" Inch Inlet, 4" Inch Outlet	36/7/8"		4"	1990-2007 FREIGHTLINER FLD120/CENTURY CLASS CST120	BHTD3523
4401-1701	Charge Air Cooler 36-7/8" x 21-1/4" x 2-1/4" Core Dimension - 4" Inch Inlet, 4" Inch Outlet	36-7/8"		2-1/4"	1993-2002 FREIGHTLINER FLD112	6805010801
4401-1705	Charge Air Cooler 30-1/2" x 21-1/4" x 2-3/4" Core Dimension - 4" Inch Inlet, 4" Inch Outlet	30-1/2"		2-3/4"	1981-2007 WESTERN STAR 4900 SERIES/COLUMBIA 112	0123132000
4401-1712	Charge Air Cooler 25" x 27-1/4" x 2" Core Dimension - Upward Outlet	25"		2"	1988-2007 WESTERN STAR 4800 SERIES/COLUMBIA 112	BHT79052
4406-3502	Charge Air Cooler 23-3/8" x 12-5/8" x 2-3/4" Core - Curved Inlet - Fits Radiator with 30-1/2" Core Dimension - Height	23-3/8"		2-3/4"	1984-2006 International/IC Bus 1955/4200	1E3834
4401-1714	Charge Air Cooler 25" x 27-1/4" x 2" Core Dimension - Straight Outlet	25"		2"	1992-2007 FREIGHTLINER FL70/FS65	BHTD5472
4406-3501	Charge Air Cooler 24-5/8" x 11-5/8" x 2-3/4" Core Dimension - Straight Connections; Fits Radiator with 31-1/8" Core Dimension - Height	24-5/8"		2-3/4"	1984-2006 International/IC Bus 1955/4200	1697719C1

FAN DRIVES



See Application Reference table immediately following for reference to OEM part numbers and Make/ Model.
If there are any questions regarding correct fit or application, please contact BorgWarner Tech Service at 800-927-7811

FAN DRIVES FROM BORGWARNER

- Precise air-flow management allows tighter control of engine temperature to help reduce tailpipe emissions.
- Maintenance-free design provides long product life and high dependability.
- Less parasitic horsepower loss frees engine power for other tasks.

Table 7-5: Fan Drives from BorgWarner

Part Number	Description	Replaces
17858-1	Fan Drive 710 Series	Prevost G5006027
010021488	Fan Drive 790 Series	Navistar 3615038C4
17690-1A	Fan Drive 800 Series	NeoPart 566000
010021288	Fan Drive 805 Series	Navistar 3609117C2
010021530	Fan Drive 805 Series	Navistar 3540116C3
010024281	Fan Drive 805 Series	Navistar 3892947C1
010021994	Fan Drive 842b Series	Navistar 3609118C1
1090-09000-01	Fan Drive (K22 Front Air)	Neopart KYS10900800001 Orion Bus OB080020

FAN DRIVE Kits from BORGWARNER

Table 7-6: Fan Drive Kits from BorgWarner

Part Number	Description	Replaces
1033-09340-01	Liner Replacement Kit for Fan Clutch	Neopart KYS10900800001 Orion Bus OB080021
4043-41130-01	Seal Replacement Kit for Fan Clutch	Neopart KYS10900800001 Orion Bus OB080022

Information Provided by BorgWarner



FAN DRIVES FROM HORTON

For additional information please call Horton
Customer Service at 1-800-621-1320 or +1 651-361-6400

Table 7-7: Fan Drives from Horton

Part Number	Description	New Blade PN	Reman #	Major Maintenance Kit	Other Maintenance Kits
DM AVANTAGE					
99A9859	DM Advantage Pneumatic On/Off Fan Drive	n/a	n/a	n/a	DM Advantage Reman Fan Drive Conversion Super Kit: 995568 Seal Kit: 994346 Liner Kit: 995047
DRIVEMASTER PNEUMATIC					
999291	DriveMaster Pneumatic On/Off Fan Drive	n/a	79A9291	n/a	DM Advantage Reman Fan Drive Conversion Super Kit: 995568 Seal Kit: 994346 Liner Kit: 995047
999457	DriveMaster Pneumatic On/Off Fan Drive	995711253	799457	n/a	DM Advantage Reman Fan Drive Conversion Super Kit: 995568 Seal Kit: 994346 Liner Kit: 995047
999157	DriveMaster Pneumatic On/Off Fan Drive	n/a	n/a	n/a	DM Advantage Reman Fan Drive Conversion Super Kit: 995568 Seal Kit: 994346 Liner Kit: 995047
999292	DriveMaster Pneumatic On/Off Fan Drive	n/a	n/a	n/a	DM Advantage Reman Fan Drive Conversion Super Kit: 995568 Seal Kit: 994346 Liner Kit: 995047
999289	DriveMaster Pneumatic On/Off Fan Drive	n/a	n/a	n/a	DM Advantage Reman Fan Drive Conversion Super Kit: 995568 Seal Kit: 994346 Liner Kit: 995047

Information & Images Provided by Horton

Part Number	Description	New Blade PN	Reman #	Major Maintenance Kit	Other Maintenance Kits
999453	DriveMaster Pneumatic On/Off Fan Drive	991813253	n/a	n/a	Bearing Kit: 995548 Clutch Pack Kit: 995035 Friction Disc Kit: 994348 Friction Liner Kit: 994349 PolarExtreme Clutch Pack Kit: 995036 PolarExtreme Friction Disc Kit: 995047 PolarExtreme Friction Liner Kit: 995046 PolarExtreme Super Kit: 994902 PolarForce
999337	DriveMaster Pneumatic On/Off Fan Drive	n/a	n/a	n/a	Clutch Pack Kit: 995035 DMA Conversion Bearing Kit: 995574 DMA Conversion Super Kit: 995568 Friction Disc Kit: 994348 Friction Liner Kit: 994349 PolarExtreme Clutch Pack Kit: 995036 PolarExtreme Friction Disc Kit: 995047 PolarExtreme Friction Liner Kit: 9
999853	DriveMaster Pneumatic On/Off Fan Drive	n/a	799853	n/a	PolarExtreme Super Kit: 994902 Seal Kit: 994346 Liner Kit: 995046
999717	DriveMaster Pneumatic On/Off Fan Drive	n/a	799853-2	995511	Seal Kit: 994346 Liner Kit: 995046

HT/S PNEUMATIC

990001	HT/S Pneumatic On/ Off Fan Drive	n/a	n/a	994314	PolarExtreme Seal Kit: 994370 Seal Kit: 994205 Super Kit: 994307
990002	HT/S Pneumatic On/Off Fan Drive	n/a	n/a	994314	PolarExtreme Seal Kit: 994370 Seal Kit: 994205 Super Kit: 994307
990052	HT/S Pneumatic On/Off Fan Drive	n/a	n/a	994314	PolarExtreme Seal Kit: 994370 Seal Kit: 994205 Super Kit: 994307
990053	HT/S Pneumatic On/Off Fan Drive	n/a	n/a	994314	PolarExtreme Seal Kit: 994370 Seal Kit: 994205 Super Kit: 994307
990139	HT/S Pneumatic On/Off Fan Drive	n/a	790012	994314	PolarExtreme Seal Kit: 994370 Seal Kit: 994205 Super Kit: 994307
990158	HT/S Pneumatic On/Off Fan Drive	n/a	n/a	994314	PolarExtreme Seal Kit: 994370 Seal Kit: 994205 Super Kit: 994307
996147	HT/S Pneumatic On/Off Fan Drive	n/a	n/a	See comment at top of section	n/a
996711	HT/S Pneumatic On/Off Fan Drive	n/a	n/a	See comment at top of section	n/a

Information & Images Provided by Horton

Part Number	Description	New Blade PN	Reman #	Major Maintenance Kit	Other Maintenance Kits
996612	HT/S Pneumatic On/Off Fan Drive	n/a	n/a	See comment at top of section	n/a
996611	HT/S Pneumatic On/Off Fan Drive	n/a	n/a	See comment at top of section	n/a
990052	HT/S Pneumatic On/Off Fan Drive	n/a	n/a	994314	PolarExtreme Seal Kit: 994370 Seal Kit: 994205 Super Kit: 994307
990072	HT/S Pneumatic On/Off Fan Drive	n/a	n/a	994314	PolarExtreme Seal Kit: 994370 Seal Kit: 994205 Super Kit: 994307
990075	HT/S Pneumatic On/Off Fan Drive	n/a	790012	994314	PolarExtreme Seal Kit: 994370 Seal Kit: 994205 Super Kit: 994307
990088	HT/S Pneumatic On/Off Fan Drive	n/a	n/a	994314	PolarExtreme Seal Kit: 994370 Seal Kit: 994205 Super Kit: 994307
990128	HT/S Pneumatic On/Off Fan Drive	n/a	790030	994314	PolarExtreme Seal Kit: 994370 Seal Kit: 994205 Super Kit: 994307
990128	HT/S Pneumatic On/Off Fan Drive	n/a	790030	994314	PolarExtreme Seal Kit: 994370 Seal Kit: 994205 Super Kit: 994307

HT650 PNEUMATIC

991453	HT650 Pneumatic Fan Drive	n/a	n/a	n/a	Minor Seal Kit: 994317
--------	---------------------------	-----	-----	-----	------------------------

MAGFORCE ELECTROMAGNETIC

996708	MagForce Electro-magnetic Fan Drive	n/a	n/a	No Kits Available, replace with new service clutch	n/a
996710	MagForce Electro-magnetic Fan Drive	n/a	n/a	No Kits Available, replace with new service clutch	n/a
996132	MagForce Electro-magnetic Fan Drive	n/a	n/a	No Kits Available, replace with new service clutch	n/a
996134	MagForce Electro-magnetic Fan Drive	n/a	n/a	No Kits Available, replace with new service clutch	n/a
996088	MagForce Electro-magnetic Fan Drive	n/a	n/a	No Kits Available, replace with new service clutch	n/a
996043	MagForce Electro-magnetic Fan Drive	n/a	n/a	995568	n/a

Information & Images Provided by Horton

Part Number	Description	New Blade PN	Reman #	Major Maintenance Kit	Other Maintenance Kits
-------------	-------------	--------------	---------	-----------------------	------------------------

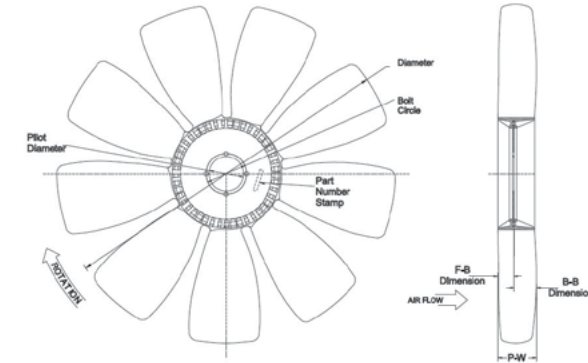


FAN DRIVES FROM HORTON - ELECTRONIC DIRECT SENSING VISCOS FAN DRIVE

9904015	Electronic Direct-Sensing Viscous Fan Clutch	995711502	n/a	No Kits Available, replace with new service clutch	n/a
9904026	Electronic Direct-Sensing Viscous Fan Clutch	n/a	n/a	No Kits Available, replace with new service clutch	n/a

Information & Images Provided by Horton

FANS



For Fan Drives See pg. 7-14.

FANS

All fans have either the entire BorgWarner part number or the last five digits of the part number engraved on the steel center disk. For example, 4735-41392-22 may be engraved as the entire part number or simply as 392-22. This is the best method for determining the correct fan for the application.

Some of the differences in the two below are if the center disk is flat or concave to the front or rear. If the customer has the fan in front of them, reading the part number on the disk is the best way to get the correct part ordered.

FANS & FAN ASSEMBLY PIECES

- All fans are plastic with steel mounting disc

Table 7-8: Fans from BorgWarner

Part Number	Description	Direction	Pitch Width
-------------	-------------	-----------	-------------

FANS FROM BORGWARNER - 7 BLADE

4735-41296-117	Fan - 7 Blade, 22" Diameter, 2.187" Pilot Hole	CCW	
4735-35828-14	Fan - 7 Blade, 26" Diameter, 2.000" Pilot Hole	CCW	2.72"
4735-41296-10	Fan - 7 Blade, 26" Diameter, 2.000" Pilot Hole	CCW	4.00"
4735-35828-32	Fan - 7 Blade, 30" Diameter, 2.000" Pilot Hole	CCW	
4735-35828-21	Fan - 7 Blade, 30" Diameter, 2.562" Pilot Hole	CCW	
4735-35828-98	Fan - 7 Blade, 30" Diameter, 4.000" Pilot Hole	CCW	
4735-35828-99	Fan - 7 Blade, 30" Diameter, 5.001" Pilot Hole	CCW	
4735-35828-34	Fan - 7 Blade, 32" Diameter, 2.000" Pilot Hole	CCW	
4735-35828-37	Fan - 7 Blade, 32" Diameter, 5.001" Pilot Hole	CCW	
4735-35828-124	Fan - 7 Blade, 34" Diameter, 3.687" Pilot Hole	CCW	

FANS FROM BORGWARNER - 8 BLADE

4735-43889-25	Fan - 8 Blade, 36" Diameter, 5.001" Pilot Hole	CW	2.99"
4735-42904-77	Fan - 8 Blade, 25" Diameter, 2.000" Pilot Hole	CW	
4735-42904-06	Fan - 8 Blade, 28" Diameter, 2.000" Pilot Hole	CW	
4735-41135-06	Fan - 8 Blade, 32" Diameter, 1.002" Pilot Hole	CW	
4735-42904-02	Fan - 8 Blade, 32" Diameter, 2.000" Pilot Hole	CW	

Information & Images Provided by BorgWarner

Part Number	Description	Direction	Pitch Width
FANS FROM BORGWARNER - 9 BLADE, CW			
010011656	Fan - 9 Blade, 25" Diameter, 2.000" Pilot Hole	CW	3.65"
4735-44566-06	Fan - 9 Blade, 30" Diameter, 2.562" Pilot Hole	CW	3.35"
4735-43480-27	Fan - 9 Blade, 24" Diameter, 2.000" Pilot Hole	CW	
4735-43783-29	Fan - 9 Blade, 25" Diameter, 1.002" Pilot Hole	CW	
4735-43217-20	Fan - 9 Blade, 25" Diameter, 2.000" Pilot Hole	CW	
4735-43217-24	Fan - 9 Blade, 25" Diameter, 3.250" Pilot Hole	CW	
4735-43217-02	Fan - 9 Blade, 26" Diameter, 2.000" Pilot Hole	CW	
4735-43782-17	Fan - 9 Blade, 26" Diameter, 5.001" Pilot Hole	CW	3.65"
4735-41393-34	Fan - 9 Blade, 26" Diameter, 5.001" Pilot Hole	CW	3.50"
4735-41392-22	Fan - 9 Blade, 28" Diameter, 2.000" Pilot Hole	CW	3.50"
4735-43440-18	Fan - 9 Blade, 28" Diameter, 2.000" Pilot Hole	CW	3.79"
4735-43783-17	Fan - 9 Blade, 28" Diameter, 2.000" Pilot Hole	CW	3.65"
4735-41393-05	Fan - 9 Blade, 28" Diameter, 2.562" Pilot Hole	CW	
4735-41392-64	Fan - 9 Blade, 28" Diameter, 4.000" Pilot Hole	CW	
4735-43783-05	Fan - 9 Blade, 28" Diameter, 5.001" Pilot Hole	CW	
4735-41393-14	Fan - 9 Blade, 30" Diameter, 1.002" Pilot Hole	CW	
4735-41392-02	Fan - 9 Blade, 30" Diameter, 2.000" Pilot Hole	CW	3.50"
4735-43440-10	Fan - 9 Blade, 30" Diameter, 2.000" Pilot Hole	CW	3.79"
4735-41393-80	Fan - 9 Blade, 30" Diameter, 2.187" Pilot Hole	CW	
4735-41393-01	Fan - 9 Blade, 30" Diameter, 2.562" Pilot Hole	CW	3.35"
4735-41392-76	Fan - 9 Blade, 30" Diameter, 4.000" Pilot Hole	CW	
4735-43440-04	Fan - 9 Blade, 32" Diameter, 1.002" Pilot Hole	CW	
4735-41393-07	Fan - 9 Blade, 32" Diameter, 2.000" Pilot Hole	CW	3.50"
4735-43440-02	Fan - 9 Blade, 32" Diameter, 2.000" Pilot Hole	CW	3.79"
4735-41392-07	Fan - 9 Blade, 32" Diameter, 2.000" Pilot Hole	CW	3.50"
4735-41393-08	Fan - 9 Blade, 32" Diameter, 2.562" Pilot Hole	CW	3.50"
4735-43440-01	Fan - 9 Blade, 32" Diameter, 2.562" Pilot Hole	CW	3.79"
4735-41392-78	Fan - 9 Blade, 32" Diameter, 4.000" Pilot Hole	CW	
4735-41391-09	Fan - 9 Blade, 32" Diameter, 5.001" Pilot Hole	CW	

FANS FROM BORGWARNER - 9 BLADE, CCW

4735-43786-03	Fan - 9 Blade, 24" Diameter, 2.562" Pilot Hole	CCW	3.50"
4735-42623-41	Fan - 9 Blade, 24" Diameter, 2.000" Pilot Hole	CCW	
4735-42622-02	Fan - 9 Blade, 30" Diameter, 2.000" Pilot Hole	CCW	3.60"
4735-42623-02	Fan - 9 Blade, 30" Diameter, 2.000" Pilot Hole	CCW	3.60"
4735-42622-01	Fan - 9 Blade, 30" Diameter, 2.562" Pilot Hole	CCW	
4735-42622-125	Fan - 9 Blade, 32" Diameter, 1.500" Pilot Hole	CCW	
4735-42622-27	Fan - 9 Blade, 32" Diameter, 2.000" Pilot Hole	CCW	
4735-42621-09	Fan - 9 Blade, 32" Diameter, 5.001" Pilot Hole	CCW	3.60"

Information & Images Provided by BorgWarner

Part Number	Description	Direction	Pitch Width
4735-42622-09	Fan - 9 Blade, 32" Diameter, 5.001" Pilot Hole	CCW	3.60"
4735-42623-09	Fan - 9 Blade, 32" Diameter, 5.001" Pilot Hole	CCW	3.60"
4735-42623-512	Fan - 9 Blade, 34" Diameter, 2.562" Pilot Hole	CCW	3.60"
4735-42622-512	Fan - 9 Blade, 34" Diameter, 2.562" Pilot Hole	CCW	3.60"
4735-42622-113	Fan - 9 Blade, 34" Diameter, 3.687" Pilot Hole	CCW	
4735-42623-505	Fan - 9 Blade, 36" Diameter, 2.562" Pilot Hole	CCW	3.60"
4735-42622-505	Fan - 9 Blade, 36" Diameter, 2.562" Pilot Hole	CCW	3.60"

FANS FROM BORGWARNER - 10 BLADE

4735-38449-06	Fan - 10 Blade, 22" Diameter, 1.002" Pilot Hole	CW	
4735-38449-09	Fan - 10 Blade, 22" Diameter, 2.000" Pilot Hole	CW	
4735-38449-70	Fan - 10 Blade, 22" Diameter, 3.250" Pilot Hole	CW	
4735-42599-04	Fan - 10 Blade, 30" Diameter, 2.000" Pilot Hole	CCW	

FANS FROM BORGWARNER - 11 BLADE

4735-44616-01	Fan - 11 Blade, 32" Diameter, 2.562" Pilot Hole	CW	3.90"
---------------	---	----	-------

See Application Reference table immediately following for reference to OEM part numbers and Make/ Model. If there are any questions regarding correct fit or application, please contact BorgWarner Tech Service at 800-927-7882.

Table 7-9: Fan Kits from BorgWarner

Part Number	Description	Replaces
FAN MOUNTING KITS FROM BORGWARNER		
1097-09115-01	Fan Mounting Kit for 4" Pilot Hole fans without bolt holes	Prevost G1014487

Table 7-10: Fan Kits from BorgWarner

Part Number	Description	Replaces
VALVES FROM BORGWARNER		
1056-07996-01	Solenoid Valve	Blue Bird 1874965

Information & Images Provided by BorgWarner

BUS APPLICATIONS FOR FANS

BUS APPLICATIONS FOR FANS

BLUE BIRD OE

Table 7-11: Fans - Blue Bird OE

Blue Bird OE	Part Number
54331	010011656
1997824	1034-09044-01
1997832	1034-09046-01
6616	1034-09066-01
57376	1034-09368-01
57377	1034-09368-02
1874965	1056-07996-01
1855634	4735-43217-02
46421	4735-43783-17
52464	4735-43783-29

BLUE BIRD AFTERMARKET

Table 7-12: Fans - Blue Bird Aftermarket

Blue Bird OE Aftermarket	Part Number
54331	010011656
4279253	1010-06385-01
0092296	1017-07726-01
2117554	1017-32150-01
00044355	1018-06574-01
4312229	1033-06639-01
1478601	1034-07663-01
1478593	1034-07665-01
1997832	1034-09046-01
0006616	1034-09066-01
0057377	1034-09368-02
1874965	1056-07996-01
4285813	4088-10805-01
1610294	4735-38449-06

1664176	4735-38449-09
1477710	4735-38449-70
1743970	4735-41393-07
1458504	4735-42904-77
1855634	4735-43217-02
1967546	4735-43217-20
1997949	4735-43217-24
46421	4735-43783-17
52464	4735-43783-29

MCI

Table 7-13: Fans - MCI

MCI OE	Part Number
6R-2-25	1017-21550-01
6G-2-3	1017-32150-01
015396	1034-07722-01
6R-2-15	4088-10805-01
6L-5-68	4735-35828-21
6L-5-5	4735-35828-32
G1015028	4735-35828-99
6L-5-59	4735-41296-10
6L-5-57	4735-41296-117
87-0900-00001	4735-41392-22
G1016868	4735-41392-64
G1074555	4735-41392-76
B1076297	4735-41392-78
87-2587-00001	4735-41393-05
T0254	4735-41393-14
6L-5-61	4735-42599-04
6L-5-66	4735-42622-01
06-05-6000	4735-42622-02
06-05-1021	4735-42622-27
6L-5-65	4735-42622-505
06-05-1004	4735-42622-512
6L-5-62	4735-42623-02
06-05-1003	4735-42623-512
N30189	4735-43440-04
06-05-1044	4735-43786-03

NABI

Table 7-14: Fans - NABI

NABI OE	Part Number
5012770	4735-41393-05
6328721	4735-41393-80
6304803	4735-42623-09
6322764	4735-42623-41
416.00.1330.901	4735-42904-02
5012471	4735-42904-06
5012053	4735-43440-02
6310098	4735-43440-04
6306237	4735-43440-10
46421	4735-43783-17
6313992	4735-35828-124

NAVISTAR

Table 7-15: Fans - Navistar

Navistar OE	Part Number
3609117C2	010021288
3615038C4	010021488
3540116C3	010021530
3609118C1	010021994
3892947C1	010024281
3616779C92	1034-09406-01
116941R1	4088-10805-01
3576854C1	4735-43782-17
3541257C1	4735-43783-05
3820083C1	4735-44616-01

NEOPART

Table 7-16: Fans - Neopart

Neopart OE	Part Number
566000	17690-1A
KYS1020013000	1020-01300-01
KYS10900800001	1090-08000-01
KYS47353582899	4735-35828-99
RC0302011	4735-41296-10
KYS40354139222	4735-41392-22
KYS47354139278	4735-41392-78
KYS47354139305	4735-41393-05
KYS40354139308	4735-41393-08
KYS40354139334	4735-41393-34
KYS47354262109	4735-42621-09
LC0302011	4735-42622-09
RC0302012	4735-42623-02
OK0302011	4735-42623-09
KYS40353749402	4735-42904-02
KYS47354344010	4735-43440-10
KYS47354344018	4735-43440-18

NEW FLYER

Table 7-17: Fans - New Flyer

New Flyer OE	Part Number
852660	030007291
5940122	1017-21550-01
5942495	1017-32150-01
1033-08255-01	1033-08255-01
1033-08255-02	1033-08255-02
003206	1034-07407-01
015396	1034-07722-01
1034-09470-01	1034-09470-01
405052	1034-09518-01
5942249	4088-10805-01
4735-35828-124	4735-35828-124
4735-41392-02	4735-41392-02
4735-41392-07	4735-41392-07
4735-41393-01	4735-41393-01
4735-41393-08	4735-41393-08
4735-42622-113	4735-42622-113

135042	4735-42623-505
4735-42904-01	4735-42904-02
132831	4735-43440-01
4735-43440-04	4735-43440-04

NOVA

Table 7-18: Fans - Nova

NOVA Bus OE	Part Number
G1203274	4735-41392-64
G1203275	4735-41392-76
G1203276	4735-41392-78
N43827	4735-42622-125
G6000226	4735-43440-01
N30189	4735-43440-04

ORION

Table 7-19: Fans - Orion

Orion Bus OE	Part Number
A0803505AC	4088-10805-01
010803122	4735-41392-07
010803122	4735-41392-02
OB080047	1033-08255-02
OB080020	1090-08000-01

PREVOST

Table 7-20: Fans - Prevost

Prevost OE	Part Number
G5006027	17858-1
550024	1017-21550-01
550568	1017-32150-01
2162042	1020-01301-02
550588	1020-01319-01
550590	1033-01529-01
550582	1033-08255-02
6964763	1034-04990-01
550292	1034-05099-01
051570	1034-07371-01
550619	1034-07528-01

G5002907	1034-07568-01
G1014487	1097-09115-01
550577	4088-10805-01
550624	4735-35828-14
550626	4735-35828-32
550622	4735-35828-34
194785	4735-35828-37
G1015022	4735-35828-98
N10455	4735-41135-06
195848	4735-41296-10
550686	4735-41391-09
195465	4735-41392-02
19501227	4735-41392-07
G1203274	4735-41392-64
G1203275	4735-41392-76
G1203276	4735-41392-78
N12870	4735-41393-01
194249	4735-41393-05
550627	4735-41393-07
T0254	4735-41393-14
194784	4735-42622-09
195852	4735-42623-02
195095	4735-42623-09
19504172	4735-42623-41
194491	4735-42904-02
195541	4735-43440-01
N30189	4735-43440-04
550757	4735-43889-25

THOMAS BUILT

Table 7-21: Fans - Thomas Built

Thomas Built OE	Part Number
61190362	1017-32150-01
86190023	1033-08255-01
86190001	4088-10805-01
61190337	4735-43480-27
61190739	4735-44566-06

ENGINE KITS (For Navistar DT466ABC and DT466E)

NAVISTAR BASIC ENGINE IDENTIFICATION

Table 7-22: Navistar Basic Engine Identification

Example: 468GM2U569749

468 (Engine Model)	G (Configuration)	M2 (Application)	U (Origin)	569749 (Unit #)
360 = A model	B = Turbo JWAC	A2 = Service	U = USA	
362 = C model	D = Natural Aspirated	M2 = Truck		
408	G = Turbo Air to Air			
466 = A model	H = HEUI			
467 = B model	T = Turbo			
468 = C model				
469 = 1st new generation				
470 = 2nd new generation				
530 = A model				
531 = B model				

All of the above models are inline six cylinder diesel engines built on a common platform. The different displacements produced are achieved by bore and stroke variation.

ESN location:

The complete engine serial number (ESN) is stamped on a pad on the side of the cylinder block. For units built prior to model year 2000 the location was on the left hand side of the block just below the cylinder head to cylinder block parting line. For model year 2000 and newer units, the serial location was moved to the right side of the cylinder block between the oil cooler and the top block.

Emission Label:

The emission label is located on top of the rocker cover or intake manifold. The engine model, model year, horsepower rating and torque rating can be obtained from this label.

Note: This information is required to determine the correct components for most units built after 1993.



IN-FRAME KITS FOR DT466ABC

Table 7-23: In-Frame Kits for DT466ABC

Part Number	Description	Qty	Note
MC1F7520E	In-Frame Kit	1	ESN 75000 - 439618
MC1F7520L	In-Frame Kit	1	ESN 436619 - 1st New Generation
MC1F4664E	In-Frame Kit with 4-Ring Pistons	1	ESN 75000 - 439618
MC1F4664L	In-Frame Kit with 4-Ring Pistons	1	ESN 436619 - 1st New Generation

OVERHAUL KITS FOR DT466ABC

Table 7-24: Overhaul Kits for DT466ABC

Part Number	Description	Qty	Note
MC0H7520E	Overhaul Kit	1	ESN 75000 - 439618
MC0H7520L	Overhaul Kit	1	ESN 439619 - 1st New Generation
MC0H4664E	Overhaul Kit with 4-Ring Pistons ESN 75000 - 439618	1	ESN 75000 - 439618
MC0H4664L	Overhaul Kit with 4-Ring Pistons ESN 439619 - 1st New Generation	1	ESN 439619 - 1st New Generation

CYLINDER COMPONENTS FOR DT466ABC

Table 7-25: Cylinder Components for DT466ABC

Part Number	Description	Qty	Note
-------------	-------------	-----	------

FOR ESN 75000 - 1ST NEW GENERATION

M1817645	Cylinder Kit ESN 75000 - 1st New Generation	6	ESN 75000 - 1st New Generation; must be used in full sets only
M1817520C2	Piston	6	must be used in full sets only
M1817247C91	Ring Set	6	
M670675C1	Piston Pin	6	
M326874R1	Pin Retainer	12	

Part Number	Description	Qty	Note
M1810504C1	Cylinder Liner	6	
M680086C1	Liner Packing Kit	6	O-rings for one liner

FOR ESN 75000 - 1ST NEW GENERATION, ALL

M675774C2	Liner O-rings	18	
-----------	---------------	----	--

FOR ESN 75000 - 1ST NEW GENERATION, WITH 4-RING PISTON

MCK466-4	Cylinder Kit with 4-Ring Piston ESN 75000 - 1st New Generation	6	ESN 75000 - 1st New Generation; must be used in full sets only
MMCB466-4	4-Ring Piston	6	must be used in full sets only
MRS466-4	Ring Set for 4-Ring Piston	6	
M670675C1	Piston Pin	6	
M326874R1	Pin Retainer	12	
M1810504C1	Cylinder Liner	6	
M680086C1	Liner Packing Kit	6	O-rings for one liner

CYLINDER HEAD COMPONENTS FOR DT466ABC

Table 7-26: Cylinder Head Components for DT466ABC

Part Number	Description	Qty	Note
SEATS			
M671559C1	Intake Seat - .002" oversize outside diameter	6	
M671561C1	Intake Seat - .015" oversize outside diameter	6	
M671563C1	Exhaust Seat - .002" oversize outside diameter	6	
M671565C1	Exhaust Seat - .015" oversize outside diameter	6	
M1811581C91	Rotator Assembly with Shield	12	ESN < 594839
M1817661C91	Rotator Assembly	12	ESN > 594840
M681234C1	Rotator Shield	12	ESN < 594839
M1815374C1	Valve Stem Seal	12	ESN > 594840; Top hat style

VALVES

M675046C4	Intake Valve	6	
M676865C4	Exhaust Valve	6	
M41339D	Valve Lock	24	
M675439C1	Valve Guide	12	ESN < 594839 (2.750"L)
M1815264C1	Valve Guide	12	ESN > 594840 (2.610"L)
M682064C1	Valve Spring	12	ESN < 532980 (2.340"L)
M677349C1	Valve Spring	12	ESN > 532981 (2.292"L)

Part Number	Description	Qty	Note
VALVES & SEATS			
M675442C1	Injector Sleeve	6	
M682840C1	Exhaust Manifold Stud		

ENGINE BEARINGS FOR DT466ABC

Table 7-27: Engine Bearings for DT466ABC

Part Number	Description	Qty	Note
CAM BEARING SETS			
M680117C1	Cam Bearing Set	1	
CONNECTING ROD BEARINGS ESN 439618 (1.195"W)			
M681314C3	Connecting Rod Bearing - STD	6	ESN < 439618 (1.195"W)
M681315C3	Connecting Rod Bearing - .010" oversize	6	ESN < 439618 (1.195"W)
M687382C3	Connecting Rod Bearing - .020" oversize	6	ESN < 439618 (1.195"W)
M681316C3	Connecting Rod Bearing - .030" oversize	6	ESN < 439618 (1.195"W)
CONNECTING ROD BEARINGS ESN 439619 (1.255"W)			
M1808059C92	Connecting Rod Bearing - STD	6	ESN > 439619 (1.255"W)
M1808060C92	Connecting Rod Bearing - .010" oversize	6	ESN > 439619 (1.255"W)
M1808061C92	Connecting Rod Bearing - .020" oversize	6	ESN > 439619 (1.255"W)
M1808062C92	Connecting Rod Bearing - .030" oversize	6	ESN > 439619 (1.255"W)
CONNECTING ROD BUSHINGS			
M675006C1	Connecting Rod Bushing	6	
IDLER BEARINGS			
M327185R91	Idler Bearing	1	
MAIN BEARINGS ESN 439618 (1.220"W)			
M684570C93	Main Bearing - STD, 1 pack	1	ESN < 439618 (1.220"W)
M684579C93	Main Bearing - STD, 6 pack	6	ESN < 439618 (1.220"W)
M684582C93	Main Bearing - .010" oversize, 1 pack	1	ESN < 439618 (1.220"W)
M684573C93	Main Bearing - .010" oversize, 6 pack	6	ESN < 439618 (1.220"W)
M687394C3	Main Bearing - .020" oversize, 1 pack	1	ESN < 439618 (1.220"W)
M687391C3	Main Bearing - .020" oversize, 6 pack	6	ESN < 439618 (1.220"W)
M684585C93	Main Bearing - .030" oversize, 1 pack	1	ESN < 439618 (1.220"W)
M684576C93	Main Bearing - .030" oversize, 6 pack	6	ESN < 439618 (1.220"W)
MAIN BEARINGS ESN 439619 (1.293"W)			
M684579C93	Main Bearing - STD, 1 pack	1	ESN > 439619 (1.293"W)

Part Number	Description	Qty	Note
M1808069C92	Main Bearing - STD, 6 pack	6	ESN > 439619 (1.293"W)
M684582C93	Main Bearing - .010" oversize, 1 pack	1	ESN > 439619 (1.293"W)
M1808070C92	Main Bearing - .010" oversize, 6 pack	6	ESN > 439619 (1.293"W)
M687394C3	Main Bearing - .020" oversize, 1 pack	1	ESN > 439619 (1.293"W)
M1808071C92	Main Bearing - .020" oversize, 6 pack	6	ESN > 439619 (1.293"W)
M684585C93	Main Bearing - .030" oversize, 1 pack	1	ESN > 439619 (1.293"W)
M1808072C92	Main Bearing - .030" oversize, 6 pack	6	ESN > 439619 (1.293"W)

CRANKSHAFTS & SEALS FOR DT466ABC

Table 7-28: Crankshafts & Seals for DT466ABC

Part Number	Description	Qty	Note
CRANKSHAFTS			
M675669C92	Crankshaft	1	
SEALS			
M690437C93	Front Crankshaft Seal Kit	1	
M1809964C92	Rear Crankshaft Seal Kit	1	

CAMSHAFTS & LIFTERS FOR DT466ABC

Table 7-29: Camshafts & Lifters for DT466ABC

Part Number	Description	Qty	Note
CAMSHAFTS			
M1802337C1	Solid Lifter Camshaft	1	ESN 143536 to 532980
M1810744C1	Roller Lifter Camshaft	1	ESN > 532981
LIFTERS			
M911776R3	Valve Lifter - Solid - .997" outside diameter	12	ESN < 140086
M1802340C1	Valve Lifter - Solid - 1.120" outside diameter	12	ESN 140087 to 532980
M1809570C1	Valve Lifter - Roller	12	ESN > 532981

GASKETS FOR DT466ABC

Table 7-30: Gaskets for DT466ABC

Part Number	Description	Qty	Note
GASKET LISTINGS			
M673973C4	Breather Mounting Gasket	1	ESN < 618496
M688928C2	Exhaust Manifold Gasket	6	
M677082	Front Cover Gasket - Cargostar	1	Cargostar
M675813C2	Front Cover Gasket - ESN < 532980	1	ESN < 532980 S-series & Paystar
M1810510C3	Front Cover Gasket - ESN > 532981	1	ESN > 532981
M683791C2	Front End Plate Gasket - Cargostar	1	Cargostar
M675812C2	Front End Plate Gasket - ESN < 532980	1	ESN < 532980 Paystar
M675812C2	Front End Plate Gasket - ESN < 567491	1	ESN < 567491 S-series
M1813962C1	Front End Plate Gasket - ESN > 567492	1	ESN > 567492
M674754C1	Injection Pump O-ring	1	
M675609C1	Injection Pump Gasket	1	
M675477C1	Injector Nozzle Gasket	6	
M682199C2	Intake Manifold Gasket	1	
M675513C1	Oil Cooler Gasket	2	
M671827C4	Oil Pan Gasket	1	
M59658D	Oil Pan Drain Gasket	1	
M671821C2	Oil Pickup Tube Gasket - ESN < 466775	1	ESN < 466775
M1802867C1	Oil Pickup Tube Gasket - ESN > 466776	1	ESN > 466776
M675109C3	Rocker Cover Gasket	1	
M677692C2	Rocker Cover Grommet	6	
M670073C2	Turbocharger Mounting Gasket	1	
M253660R2	Turbocharger Oil Supply Gasket	1	
M670079C3	Turbocharger Oil Drain Gasket	1	
GASKET SETS			
M1817254C96	Upper Gasket Set	1	
M674399C96	Lower Gasket Set	1	ESN < 567491
M1815668C93	Lower Gasket Set	1	ESN > 567492
MCB674399	Lower Gasket Set with Crank Seals	1	ESN < 567491
MCB1815668	Lower Gasket Set with Crank Seals	1	ESN > 567492
M680084	Front Cover Gasket Set	1	ESN < 567491
M1813933C96	Front Cover Gasket Set	1	ESN > 567492

OIL COOLERS & PUMPS FOR DT466ABC

Table 7-31: Oil Coolers & Pumps for DT466ABC

Part Number	Description	Qty	Note
COOLERS			
M1810171C2	Cooler Cartridge	1	ESN > 517250
M675513C1	Mounting Gasket	2	
M252483R1	Seal Ring	4	
PUMPS			
M1802666C92	Rotor Set - 1.00" Thick	1	ESN < 466775
M1808832C92	Rotor Set - 1.25" Thick	1	ESN > 466776

WATER SYSTEM COMPONENTS FOR DT466ABC

Table 7-32: Water System Components for DT466ABC

Part Number	Description	Qty	Note
WATER THERMOSTATS			
M1801191C91	Water Thermostat Kit	1	Includes seal & gasket; Coolant used at 180°F
PUMPS			
M685155C94	Water Pump - ESN < 642459 S-series & Paystar	1	ESN < 642459 S-series & Paystar
M680899C2	Water Pump - ESN < 642459 Cargostar	1	ESN < 642459 Cargostar
M1815538C91	Water Pump - ESN > 642460	1	ESN > 642460 Screw-on fan drive

Kit contains: cylinder kit, gasket set, main and rod bearings



IN-FRAME KITS FOR DT466E

Table 7-33: In-Frame Kits for DT466E

Part Number	Description	Note
M1841391C91	In-Frame Kit (Old Kit Number: M-1825690)	ESN 980820 - 1194038 175-210ST
M1833446	In-Frame Kit (Old Kit Number: M-1824966)	ESN < 1126948 210HT & 230-250 All
M183566	In-Frame Kit (Old Kit Number: M-183565)	ESN 1126949 - 1194038 230-250 All

Part Number	Description	Note
M1836195C96	In-Frame Kit (Old Kit Number: M-1836192C91)	ESN > 1194039 175-215 All
M1836300C94	In-Frame Kit (Old Kit Number: M-1836299C91)	ESN > 1194039 230-250 All
M1879703C94	In-Frame Kit (Old Kit Number: M-1842554C93)	
M1879705C93	In-Frame Kit (Old Kit Number: M-1842556C94)	
M1880991C94	In-Frame Kit (Old Kit Number: M-1876100C92)	
M1885597C92	In-Frame Kit (Old Kit Number: M-1850403C92)	
M1842661C95	In-Frame Kit	

CYLINDER COMPONENTS FOR DT466E

Table 7-34: Cylinder Components for DT466E

Part Number	Description	Qty	Note
FOR ESN = 980820 - 1194038, 175-210ST			
M1825690	Cylinder Kit ESN 980820 - 1194038 175-210ST	6	ESN 980820 - 1194038 175-210ST
M1825585	Piston	6	
M1824461	Ring Set	6	
M1818552	Piston Pin	6	
M1818702	Pin Retainer	12	
M1815674C1	Cylinder Liner	6	
M1822322	Liner Packing Kit	6	O-rings for one liner

FOR ESN = 981120 - 1194038, 250-275 HP ALL

M1842556C94	Cylinder Kit ESN 981120 - 1194038, 250-275 HP All	6	ESN 981120 - 1194038, 250-275 HP All
M1842622C2	Piston	6	
M1842551C92	Ring Set	6	
M1874253C1	Piston Pin	6	M-1830060C1
M1818702C1	Pin Retainer	12	
M1841326C1	Cylinder Liner	6	
M1842115C1	Liner Seal Ring	6	

FOR ESN < 1126948 210HT & 230-250 HP ALL

M1824966	Cylinder Kit ESN < 1126948 210HT & 230-250 All	6	ESN < 1126948 210HT & 230-250 All
M1823313	Piston	6	
M1817247C91	Ring Set	6	
M1818552	Piston Pin	6	
M1818702	Pin Retainer	12	
M1815674C1	Cylinder Liner	6	
M1822322	Liner Packing Kit	6	O-rings for one liner

Part Number	Description	Qty	Note
FOR ESN = 1126949 - 1194038, 230-250 HP ALL			
M1830565C91	Cylinder Kit ESN 1126949 - 1194038 230-250 All	6	ESN 1126949 - 1194038 230-250 All
M1830375C1	Piston	6	
M1817247C91	Ring Set	6	
M1818552	Piston Pin	6	
M1818702	Pin Retainer	12	
M1815674C1	Cylinder Liner	6	
M1822322	Liner Packing Kit	6	O-rings for one liner

FOR ESN > 1194039, 175-215 HP ALL

M1836192C91	Cylinder Kit ESN > 1194039 175-215 All	6	ESN > 1194039 175-215 All
M1836321C1	Piston	6	
M1876098C91	Ring Set	6	
M1830060C1	Piston Pin	6	
M1818702	Pin Retainer	12	
M1830706C1	Cylinder Liner	6	
M1822322	Liner Packing Kit	6	O-rings for one liner
M1842115C1	Liner Seal Ring	6	
M1836192C91	Cylinder Kit ESN > 1194039 175-215 All	6	ESN > 1194039 175-215 All
M1847682C2	Piston	6	
M1836193C91	Ring Set	6	
M1874253C1	Piston Pin	6	M-1830060C1
M1818702C1	Pin Retainer	12	
M1841326C1	Cylinder Liner	6	
M1822322	Liner Packing Kit	6	O-rings for one liner
M1876100C92	Cylinder Kit ESN > 1194039, 175-215 HP All	6	ESN > 1194039, 175-215 HP All
M1836321C1	Piston	6	
M1830724C92	Ring Set	6	
M1830060C1	Piston Pin	6	
M1818702	Pin Retainer	12	
M1841326C1	Cylinder Liner	6	

FOR ESN > 1194039, 230-250 HP ALL

M1850403C92	Cylinder Kit ESN > 1194039, 230-250 HP All	6	ESN > 1194039, 230-250 HP All
M1858121C1	Piston	6	
M1850402C91	Ring Set	6	
M1874253C1	Piston Pin	6	M-1830060C1
M1818702C1	Pin Retainer	12	
M1841326C1	Cylinder Liner	6	
M1842115C1	Liner Seal Ring	6	
M1836299C91	Cylinder Kit ESN > 1194039 230-250 All	6	ESN > 1194039 230-250 All

Part Number	Description	Qty	Note
M1830591C2	Piston	6	
M1830723C92	Ring Set	6	
M1830060C1	Piston Pin	6	
M1818702	Pin Retainer	12	
M1830706C1	Cylinder Liner	6	
M1822322	Liner Packing Kit	6	O-rings for one liner

FOR ESN > 1194039, 250-275 HP ALL

M1842554C93	Cylinder Kit ESN > 1194039, 250-275 HP All	6	ESN > 1194039, 250-275 HP All
M1842227C1	Piston	6	
M1830724C92	Ring Set	6	
M1874253C1	Piston Pin	6	M-1830060C1
M1818702C1	Pin Retainer	12	
M1841326C1	Cylinder Liner	6	
M1842115C1	Liner Seal Ring	6	

CYLINDER HEAD COMPONENTS FOR DT466E - ESN 1194038

Table 7-35: Cylinder Head Parts for DT466E - ESN 1194038

Part Number	Description	Qty	Note
SEATS			
M1821900C1	Intake Seat - STD	6	
M1821901C1	Intake Seat - .002" oversize	6	
M1821902C1	Intake Seat - .015" oversize	6	
M1821903C3	Exhaust Seat - STD	6	
M1821904C3	Exhaust Seat - .002" oversize	6	
M1821905C3	Exhaust Seat - .015" oversize	6	
M1824680C1	Rotator Retainer with Shield	12	
M1824683C1	Rotator Shield	12	
M1823925C1	Valve Stem Seal	12	Top hat style

VALVES

M1823875C2	Intake Valve	6	
M1824840C1	Exhaust Valve	6	

Part Number	Description	Qty	Note
M1824644C1	Valve Lock	24	
M1824647C1	Valve Guide	12	
M677349C1	Valve Spring - Intake	6	
M1825540C1	Valve Spring - Exhaust	6	

VALVES & SEATS

M1818778C2	Injector Sleeve	6	
M1809570C2	Roller Tappet	12	

CYLINDER HEAD COMPONENTS FOR DT466E - ESN 1194039 - 2000000

Table 7-36: Cylinder Head Parts for DT466E - ESN 1194039 - 2000000

Part Number	Description	Qty	Note
SEATS			
M1827121C2	Intake Seat - STD	6	
M1830310C2	Intake Seat - .002" oversize	6	
M1830311C2	Intake Seat - .015" oversize	6	
M1830711C1	Exhaust Seat - STD	6	
M1830712C1	Exhaust Seat - .002" oversize	6	
M1830713C1	Exhaust Seat - .015" oversize	6	
M1824680C1	Rotator Retainer with Shield	12	
M1824683C1	Rotator Shield	12	
M1823925C1	Valve Stem Seal	12	Top hat style

VALVES

M1826471C1	Intake Valve	6	
M1824840C1	Exhaust Valve	6	
M1824644C1	Valve Lock	24	
M1824647C1	Valve Guide	12	
M677349C1	Valve Spring - Intake	6	
M1825540C1	Valve Spring - Exhaust	6	

SEATS & VALVES

M1833382C1	Injector Sleeve	6	
M1809570C2	Roller Tappet	12	

ENGINE BEARINGS FOR DT466E

Table 7-37: Engine Bearings for DT466E

Part Number	Description	Qty	Note
CAM BEARINGS			
M680117C1	Cam Bearing Set - ESN 1194038	1	
M675424C1	Cam Bearing Front	1	
M1842054C1	Cam Bearing Intermediate	2	
M1842053C1	Cam Bearing Rear	1	

CONNECTING ROD BEARINGS ESN 1194038

M1822389	Connecting Rod Bearing - STD	6	ESN < 1194038
M1822486	Connecting Rod Bearing - .010" oversize	6	ESN < 1194038
M1822487	Connecting Rod Bearing - .020" oversize	6	ESN < 1194038
M1822488	Connecting Rod Bearing - .030" oversize	6	ESN < 1194038

CONNECTING ROD BEARINGS ESN 1194039

M1836020C91	Connecting Rod Bearing - STD, 6 pack	6	ESN > 1194039
M1842570C92	Connecting Rod Bearing - STD, 6 pack	6	ESN > 1194039
M1842900C92	Connecting Rod Bearing - .010" oversize, 6 pack	6	ESN > 1194040
M1842901C92	Connecting Rod Bearing - .020" oversize, 6 pack	6	ESN > 1194041
M1842902C92	Connecting Rod Bearing - .030" oversize, 6 pack	6	ESN > 1194042

CONNECTING ROD BUSHINGS

M1818598C1	Connecting Rod Bushing - ESN 1194038	6	
M1872733C2	Connecting Rod Bushing	6	

MAIN BEARINGS ESN 1194038

M1822379	Main Bearing - STD, 1 pack	1	ESN < 1194038
M1822321	Main Bearing - STD, 6 pack	6	ESN < 1194038
M1822494	Main Bearing - .010" oversize, 1 pack	1	ESN < 1194038
M1822490	Main Bearing - .010" oversize, 6 pack	6	ESN < 1194038
M1822495	Main Bearing - .020" oversize, 1 pack	1	ESN < 1194038
M1822491	Main Bearing - .020" oversize, 6 pack	6	ESN < 1194038
M1822496	Main Bearing - .030" oversize, 1 pack	1	ESN < 1194038
M1822492	Main Bearing - .030" oversize, 6 pack	6	ESN < 1194038

MAIN BEARINGS ESN 1194039

M1830726C91	Main Bearing - STD, 1 pack	1	ESN > 1194039
-------------	----------------------------	---	---------------

MAIN BEARINGS ESN 1194040

M1830725C91	Main Bearing - STD, 6 pack	6	ESN > 1194039
-------------	----------------------------	---	---------------

Part Number	Description	Qty	Note
MAIN BEARINGS ESN 2000000 - 3000000			
M1842567C92	Main Bearing - STD, 1 pack	1	ESN 2000000 - 3000000
M1842566C92	Main Bearing - STD, 6 pack	6	ESN 2000000 - 3000000
M1842892C91	Main Bearing - .010" oversize, 1 pack	1	ESN 2000000 - 3000000
M1842889C91	Main Bearing - .010" oversize, 6 pack	6	ESN 2000000 - 3000000
M1842893C91	Main Bearing - .020" oversize, 1 pack	1	ESN 2000000 - 3000000
M1842890C91	Main Bearing - .020" oversize, 6 pack	6	ESN 2000000 - 3000000
M1842894C91	Main Bearing - .030" oversize, 1 pack	1	ESN 2000000 - 3000000
M1842891C91	Main Bearing - .030" oversize, 6 pack	6	ESN 2000000 - 3000000

CRANKSHAFTS & SEALS FOR DT466E

Table 7-38: Crankshafts & Seals for DT466E

Part Number	Description	Qty	Note
CRANKSHAFTS			
M1830596C91	Crankshaft - ESN < 1194038	1	ESN ≤ 1194038
M1830597C91	Crankshaft - ESN > 1194039	1	ESN ≥ 1194039

SEALS

M690437C95	Front Crankshaft Seal Kit	1	
M1817867C92	Rear Crankshaft Seal Kit	1	
M1833095C93	Front Seal Kit	1	
M1841938C1	Rear Seal Kit	1	

GASKETS FOR DT466E

Table 7-39: Gaskets for DT466E

Part Number	Description	Qty	Note
GASKET SETS			
M1824970C99	Upper Gasket Set ESN < 1194038	1	ESN < 1194038
M1830720C94	Upper Gasket Set ESN > 1194039	1	ESN > 1194039
M1824985C97	Lower Gasket Set	1	
M1824984C94	Front Cover Gasket Set	1	

Part Number	Description	Qty	Note
M1833564C92	Injector Seal Ring Kit	6	
M1823181C92	Turbocharger Install Gasket Set	1	
M1823182C95	Oil Cooler Installation Gasket Set	1	
M1885598C91	Upper Gasket Set	1	
M1842663C93	Gasket Set - Front Cover/ Front Half	1	
M1842662C91	Gasket Set - Front Cover/ Rear Half	1	
M1842626C95	Gasket Set - High Pressure Oil Rail	1	
M1842623C93	Gasket Set - Turbocharger Mounting	1	
M1842588C93	Gasket Set - EGR Cooler	1	
M1842592C91	Gasket Set - EGR Mixer	1	
M1842624C92	Seal Kit - Injector Installation	6	
M1842624C92	Injector Installation Seal Ring Kit	6	

For Charge Air Coolers See pg. 7-12.



WATER SYSTEM COMPONENTS FOR DT466E

Table 7-40: Water System Components for DT466E

Part Number	Description	Qty	Note
WATER THERMOSTAT KITS			
M1830256C93	Water Thermostat Kit	1	Coolant used at 190°F
WATER PUMPS			
M1817687	Water Pump	1	



*For information, updates, or corrections,
please contact us at TRPBus@TRPParts.com*

*No part of this marketing material may be
reproduced in any manner without written
permission from TRP® North America.*

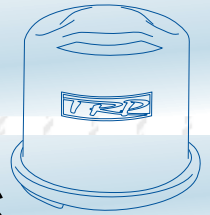
TRP® North America

750 Houser Way N.
Renton, WA 98057

www.trpparts.com



Parts for all brands of buses.



8

BUS PARTS

AIR SYSTEMS

*Proven, reliable and
always innovative.*

TRP® offers reliable aftermarket products that are designed and tested to exceed customers' expectations regardless of the bus make, model or age.



**ABS • AIR BRAKE COMPONENTS •
AIR DRYERS • AIR VALVES • CARTRIDGES**



BUS PARTS

Tested. Reliable. Guaranteed.

Air Systems

Choosing the right replacement part or service for your vehicle—whether you own one, or a fleet—is one of the most important decisions you can make for your business. And, with tested TRP® parts it's an easy decision.

Regardless of the make you drive, TRP® quality replacement parts are engineered to fit your truck, trailer or bus. Choose the parts that give you the best value for your business. Check them out at an approved TRP® retailer near you.

The cross reference information in this catalog is based upon data provided by several industry sources and our partners. While every attempt is made to ensure the information presented is accurate, we bear no liability due to incorrect or incomplete information.

Product Availability

Due to export restrictions and market demands, not all products are always available in every location. Check for availability in your area with your local TRP® Distributor.

No part of this marketing material may be reproduced in any manner without written permission from TRP® North America.

CONTENTS

ABS CABLES

ABS Cables from Meritor	8-5
ABS Modulator Extension Cables	8-5
ABS ECU's from Meritor	8-5
ABS ECU's - Cab Mount	8-5
ABS ECU's - Frame Mount	8-5

ABS SENSORS

ABS Sensors from Meritor	8-6
ABS Sensors - Straight	8-6
ABS Sensors - Right Angle	8-6

AIR BRAKE HARDWARE

Air Brake Hardware from Meritor	8-7
Spring Nuts	8-9
Spring Guard Nuts	8-9

AIR BRAKE HOSE

Air Brake Hose from Meritor	8-11
---	------

AIR DRYERS

Air Dryers	8-12
Desiccant Air Dryers	8-13
For Bendix AD-2	8-13
For Bendix AD-4	8-13

TRP® North America

750 Houser Way N.
Renton, WA 98057

www.trpparts.com

For Bendix AD-9	8-13
For Bendix AD-IP	8-14
For Bendix AD-SP/ AD-IS	8-14
Wabco Air Dryers	8-14

TROUBLESHOOTING TIPS FOR AIR DRYERS

Troubleshooting Tips For Air Dryers	8-15
---	------

AIR COMPRESSORS

Remanufactured Air Compressors (Oil-Lubed)	8-17
Remanufactured Air Compressors (Oil-Lubed)	8-18

AIR GOVERNORS

D-2 Air Governors from Bendix	8-19
D-2 Air Governors Maintenance Kit from Bendix	8-19
Additional Air Governors	8-20

BRAKE VALVES

E-8P & E-10P Brake Valves from Bendix	8-21
Brake Valves	8-22

BRAKE VALVES - ACTUATORS

BVA-85 Brake Valve Actuators from Bendix	8-24
--	------

BRAKE VALVES - PACKAGES

ABS Valve Packages from Meritor	8-25
---	------

CHECK VALVES - SINGLE

Single Check Valves from Bendix	8-26
---	------

Single Check Valves - Female Inlet/Female Outlet	8-26
Single Check Valves - Female Inlet/Male Outlet	8-26
Additional Single Check Valves	8-26

CHECK VALVES - DOUBLE

Double Check Valves from Bendix	8-27
Additional Double Check Valves	8-27

CONTROL VALVES

PP-1 Control Valves from Bendix	8-28
PP-DC Control Valves from Bendix	8-28
Additional Control Valves	8-29

MODULATING VALVES

Modulating Valves from Bendix	8-30
---	------

PRESSURE PROTECTION VALVES

Pressure Protection Valves from Bendix	8-31
Additional Pressure Protection Valves	8-32

QUICK RELEASE VALVES

Quick Release Valves from Bendix	8-33
Additional Quick Release Valves	8-35

RELAY VALVES

Relay Valves (Vertical Ports) from Bendix	8-36
Relay Valves (Horizontal Ports) from Bendix	8-37
Relay Valves (Vertical & Horizontal Ports) from Bendix	8-38
Relay Valves (Maintenance Kits) from Bendix	8-39
Additional Relay Valves	8-39

SAFETY VALVES
[Safety Valves from Bendix](#) 8-40

SPRING BRAKE VALVES
[Spring Brake Valves from Bendix](#) 8-41
[Additional Spring Brake Valves](#) 8-42

SWITCHES - LOW PRESSURE INDICATORS
[Low Pressure Indicators from Bendix](#) 8-43

SWITCHES - PARK BRAKE
[Park Brake Switches from Meritor](#) 8-44

SWITCHES - PARK BRAKE BUTTON COVERS
[Brake Button Covers from Bendix](#) 8-45
[Brake Button Covers from Meritor](#) 8-45

SWITCHES - STOP LIGHT
[Stop Light Switches from Bendix](#) 8-46
[Additional Stop Light Switches](#) 8-46

ABS CABLES



ABS CABLES FROM MERITOR

Table 8-1: ABS Cables from Meritor

Part Number	Description	Length - Feet	Length - Meters	Application Information
ABS MODULATOR EXTENSION CABLES				
S449 532 120 0	Tractor ABS Cables - ABS Modulator Valve Extension Cables	39.4 ft	12 m	n/a

ABS ECU's



Frame Mount



Cab Mount

ABS ECU's FROM MERITOR

Table 8-2: ABS ECU's from Meritor - Cab Mount

Part Number Kit	Description	Version	System	Voltage	Reman Part Number	Application Information
ABS ECU's - CAB MOUNT						
S446 004 313 0	Tractor ABS ECU - cab mounted vers. D	D	4S/ 4M	12 volts	S446 004 313 7	SAE J1922, Basic ECU
S446 004 601 0	Tractor ABS ECU - cab mounted vers. E (ATC)	E	4S/ 4M	12 volts	S446 004 601 7	SAE J1939, PLC, ATC, Basic ECU
S446 004 602 0	Tractor ABS ECU - cab mounted vers. E	E	4S/ 4M	12 volts	S400 850 602 7	SAE J1939, PLC, Basic ECU
ABS ECU's - FRAME MOUNT						
S446 106 076 0	Tractor ABS ECU - frame mounted	D	4S/ 4M	12 volts	S446 106 076 7	SAE J1922

Information & Images Provided by Meritor

ABS SENSORS



Right Angle ABS Sensor



Straight ABS Sensor

ABS SENSORS FROM MERITOR

Table 8-3: ABS Sensors (Straight) from Meritor

Part Number Kit	Description	Sensor Part Number	Cable Lead - Feet	Cable Lead - Meters
-----------------	-------------	--------------------	-------------------	---------------------

ABS SENSORS - STRAIGHT

R955338	Straight Sensor	S441 032 900 0	5.8 feet	1.8 m
---------	-----------------	----------------	----------	-------

ABS SENSORS - RIGHT ANGLE

R955336	Right Angle (90°) Sensor	S441 032 809 0	3.0 feet	0.9 m
R955341	Right Angle (90°) Sensor	S441 032 813 0	5.8 feet	1.8 m
R955342	Right Angle (90°) Sensor	S441 032 814 0	6.6 feet	2.0 m

Typically installed in heavy front axle applications (16,000 - 20,000 GAWR) at wheel ends to measure the motion of a wheel in ABS applications. Sensor kits include sensor with cable leads, spring clip, lubricant and instruction sheets. When replacing the sensor, the spring clip must also be replaced.

AIR BRAKE HARDWARE

AIR BRAKE HARDWARE FROM MERITOR



R950095

Table 8-4: Air Brake Hardware (Adapters) from Meritor

Part Number	Description	Fits Hose Inside Diameter	Pipe Thread	Overall Length
R950095	Air Brake Adapter	3/8"	1/4"-18	1-3/16"
R950096	Air Brake Adapter	3/8"	3/8"-18	1-3/16"
R950098	Air Brake Adapter	1/2"	1/2"-14	1-3/16"
R950097	Air Brake Adapter	1/2"	3/8"-18	1-3/16"



R950077

Table 8-5: Air Brake Hardware (Connectors) from Meritor

Part Number	Description	Fits Hose Inside Diameter	Pipe Thread	Overall Length	Length Added to Hose
R950077	Terminal Bolt and Frame Coupling Connector	3/8"	1/2"-14	2-29/64"	29/32"
R950075	Terminal Bolt and Frame Coupling Connector	3/8"	1/4"-18	2-17/64"	23/32"
R950076	Terminal Bolt and Frame Coupling Connector	3/8"	3/8"-18	2-23/64"	51/64"
R950079	Terminal Bolt and Frame Coupling Connector	1/2"	1/2"-14	2-29/64"	29/32"
R950078	Terminal Bolt and Frame Coupling Connector	1/2"	3/8"-18	2-23/64"	51/64"



R950082

Table 8-6: Air Brake Hardware (Connectors w/ Spring Guards) from Meritor

Part Number	Description	Fits Hose Inside Diameter	Pipe Thread	Overall Length	Length Added to Hose
R950082	Terminal Bolt and Frame Coupling Connector with Spring Guard	3/8"	1/2"-14	4-7/8"	29/32"
R950080	Terminal Bolt and Frame Coupling Connector with Spring Guard	3/8"	1/4"-18	4-3/4"	23/32"
R950081	Terminal Bolt and Frame Coupling Connector with Spring Guard	3/8"	3/8"-18	4-3/4"	51/64"
R950084	Terminal Bolt and Frame Coupling Connector with Spring Guard	1/2"	1/2"-14	4-7/8"	29/32"
R950083	Terminal Bolt and Frame Coupling Connector with Spring Guard	1/2"	3/8"-18	4-3/4"	51/64"

Information & Images Provided by Meritor



R950087

Table 8-7: Air Brake Hardware (Ferrules) from Meritor

Part Number	Description	Fits Hose Inside Diameter
R950087	Air Brake Ferrule	3/8"
R950088	Air Brake Ferrule	1/2"



R950072

Table 8-8: Air Brake Hardware (Inserts) from Meritor

Part Number	Description	Fits Hose Inside Diameter	Pipe Thread	Fitting Inside Diameter	Hex Size
R950072	Terminal Bolt and Frame Coupling Insert	3/8"	1/2"-14	9/32"	1"
R950070	Terminal Bolt and Frame Coupling Insert	3/8"	1/4"-18	9/32"	1"
R950071	Terminal Bolt and Frame Coupling Insert	3/8"	3/8"-18	9/32"	1"
R950074	Terminal Bolt and Frame Coupling Insert	1/2"	1/2"-14	25/64"	1-1/8"
R950073	Terminal Bolt and Frame Coupling Insert	1/2"	3/8"-18	25/64"	1-1/8"



R95

Table 8-9: Air Brake Hardware (Nuts) from Meritor

Part Number	Description	Fits Hose Inside Diameter
R950089	Air Brake Nut	3/8"
R950090	Air Brake Nut	1/2"



S899 759 815 4

Table 8-10: Air Brake Hardware (Sensor Clips) from Meritor

Part Number	Description	Outside Diameter	Inside Diameter	Length	Application Information
S899 759 815 4	Sensor Clip	0.71" / 18.0 mm	0.63" / 16.0 mm	1.18" / 30.0 mm	Chrome nickel sensor clip. Holds sensor in place. Kit contains sensor clip and grease packet.
S899 760 510 4	Sensor Clip	0.71" / 18.0 mm	0.63" / 16.0 mm	1.18" / 30.0 mm	Copper-beryllium sensor clip. Holds sensor in place. Kit contains sensor clip and grease packet.

Information & Images Provided by Meritor



R950093



R950091

Table 8-11: Air Brake Hardware (Spring Guards) from Meritor

Part Number	Description	Fits Hose Inside Diameter
R950093	Air Brake Spring Guard	3/8"
R950094	Air Brake Spring Guard	1/2"

SPRING NUTS

R950093	Air Brake Spring Guard	3/8"
R950094	Air Brake Spring Guard	1/2"

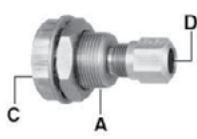
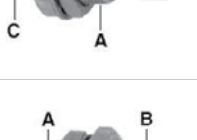
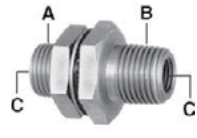

SPRING GUARD NUTS

R950091	Air Brake Spring Guard Nut	3/8"
R950092	Air Brake Spring Guard Nut	1/2"

Table 8-12: Air Brake Hardware (Bolts & Frame Couplings) from Meritor

Product	Part Number	Description	Overall Length	Measurement A	Measurement B	Measurement C	Measurement D	Notes
	R950099	Terminal Bolt and Frame Coupling	3-15/16"	1/4"-14 NPTF	1"-14 UNS	1/4"-18 NPTF	n/a	
	R950100	Terminal Bolt and Frame Coupling	2-7/8"	1"-14 UNS	1/2"-14 NPTF	1/4"-18 NPTF	n/a	
	R950101	Terminal Bolt and Frame Coupling	2-7/8"	1/4"-14 NPTF	1"-14 UNS	1/4"-18 NPTF	n/a	Same as R950100, except larger mounting nut.
	R950102	Terminal Bolt and Frame Coupling	1-11/16"	1/4"-14 NPTF	1"-14 UNS	3/8"-18 NPTF	n/a	
	R950103	Terminal Bolt and Frame Coupling	1-29/32"	1/4"-14 NPTF	1"-14 UNS	3/8"-18 NPTF	n/a	
	R950104	Terminal Bolt and Frame Coupling	2-1/8"	1/4"-14 NPTF	1"-14 UNS	1/4"-18 NPTF	n/a	
	R950105	Terminal Bolt and Frame Coupling	1-5/16"	1"-14 UNS	n/a	3/8"-18 NPTF	n/a	
	R950106	Terminal Bolt and Frame Coupling	15/16"	3/4"-16 UNS	n/a	1/4"-18 NPTF	n/a	
	R950107	Terminal Bolt and Frame Coupling	1-1/2"	3/4"-16 UNS	n/a	1/4"-18 NPTF	n/a	

Information & Images Provided by Meritor

Product	Part Number	Description	Overall Length	Measurement A	Measurement B	Measurement C	Measurement D	Notes
	R950108	Terminal Bolt and Frame Coupling	1-5/16"	7/8"-20 UNF	n/a	3/8"-18 NPTF	1/2" O.D. Tube	
	R950109	Terminal Bolt and Frame Coupling	1-3/8"	7/8"-20 UNF	n/a	3/8"-18 NPTF	3/8" O.D. Tube	
	R950110	Terminal Bolt and Frame Coupling	1-11/16"	1/4"-14 NPTF	3/4"-16 UNS	1/4"-18 NPTF	n/a	
	R950111	Terminal Bolt and Frame Coupling	2-5/32"	1/4"-14 NPTF	3/4"-16 UNS	1/4"-18 NPTF	n/a	



R950085

Table 8-13: Air Brake Hardware (Unions) from Meritor

Part Number	Description	Fits Hose Inside Diameter	Insert Hex Size	Overall Length
R950085	Air Brake Hose Union	3/8"	1"	3-1/4"
R950086	Air Brake Hose Union	1/2"	1/8"	3-1/4"

Information & Images Provided by Meritor

AIR BRAKE HOSE



AIR BRAKE HOSE FROM MERITOR

Table 8-14: Bulk Air Brake Hose from Meritor

Part Number	Description	Inside Diameter	Outside Diameter	Quantity
R955500-BK	Bulk Air Brake Hose	3/8"	3/4"	250 feet per reel
R955500	Bulk Air Brake Hose	3/8"	3/4"	50 feet per box
R955501-BK	Bulk Air Brake Hose	1/2"	7/8"	250 feet per reel
R955501	Bulk Air Brake Hose	1/2"	7/8"	50 feet per box

Information & Images Provided by Meritor

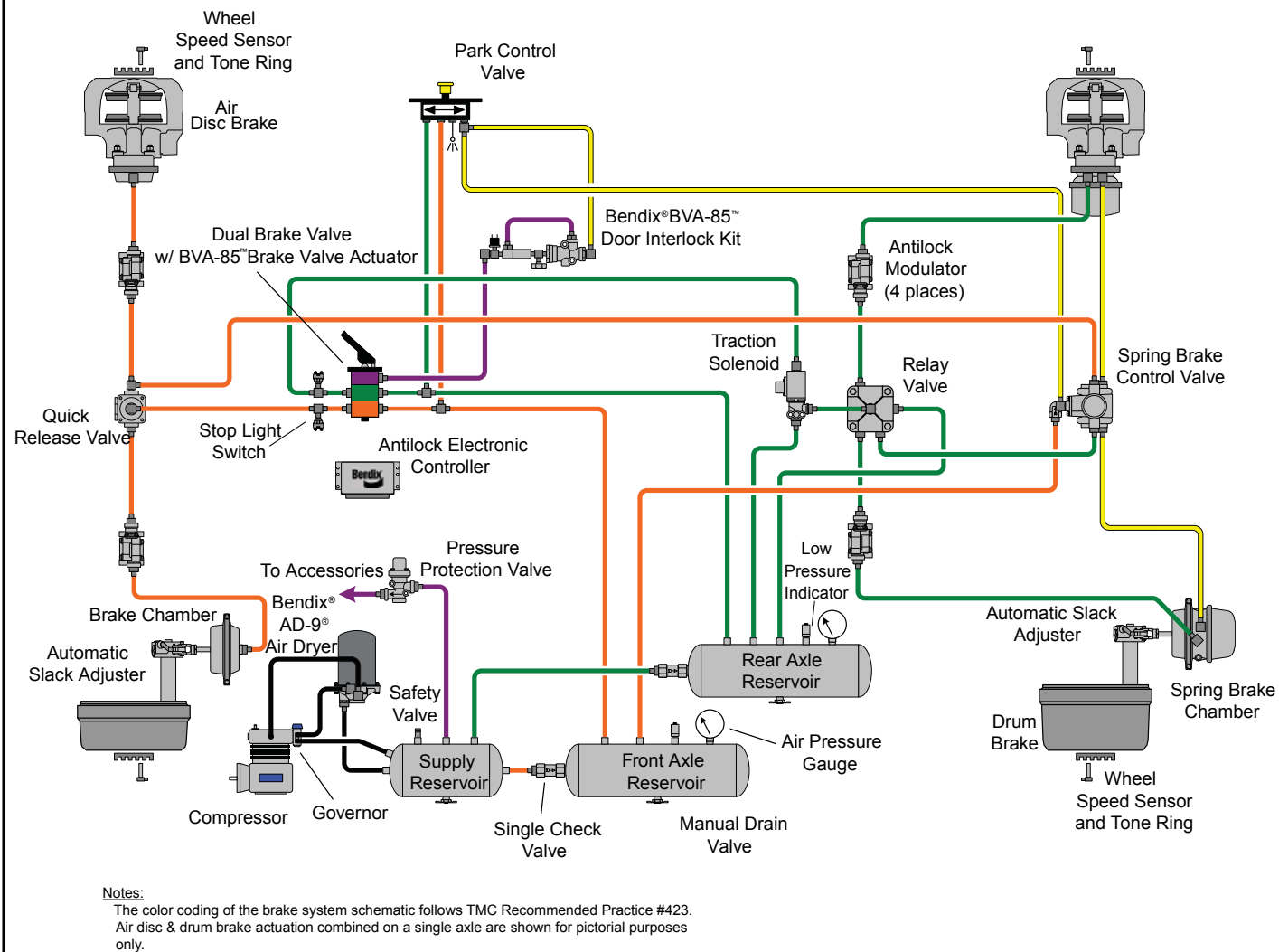
AIR DRYERS



For Air Compressors See pg. 8-17.



Typical School Bus Air System Schematic with a Bendix® AD-9® Air Dryer



Notes:
The color coding of the brake system schematic follows TMC Recommended Practice #423. Air disc & drum brake actuation combined on a single axle are shown for pictorial purposes only.

SCHOOL BUS:
 ■ Charging ■ Primary ■ Secondary ■ Parking (Control) ■ Accessories

Information & Images Provided by Bendix



R955065624N



R109994



R955800405N



R955109578N



R955109578N



R955286934X



R955109477X



R955103981N



R955109685N



R955107796N



R955800405N



R955109578N

Air Dryer and Cartridges - Desiccant-style air dryers are like inline filters that remove both liquid and vapor from compressor discharge before it reaches the reservoir. As a result, only clean, dry air is supplied to the air system. This helps prevent freeze-ups and prolongs the life of air system components.

DESICCANT AIR DRYERS

Table 8-15: Desiccant Air Dryers

Part Number	Description	Voltage	Watts	Comments
FOR BENDIX AD-2				
Bendix 286934X Meritor R955286934X	Remanufactured Air Dryer (Replaces Bendix AD-2 air dryer)	n/a	n/a	
FOR BENDIX AD-4				
Bendix 103981 Meritor R955103981N	Desiccant cartridge (Replaces Bendix AD-4 cartridge)	n/a	n/a	
FOR BENDIX AD-9				
Bendix 065225 Meritor R955065225N	Air Dryer (with bracket) (Replaces Bendix AD-9 air dryer)	12 volt	n/a	With bracket and power cable
Bendix 109685 Meritor R955109685N	Air Dryer (no bracket) (Replaces Bendix AD-9 air dryer)	12 volt	n/a	
TRP® AC2001 Bendix 107796 Meritor R955107796N	Desiccant cartridge (Replaces Bendix AD-9 cartridge)	n/a	n/a	
Bendix 109578 Meritor R955109578N	Heater/ Thermostat Assembly (Replaces Bendix AD-9 thermostat)	12 volt	75 Watts	Heater/Thermostat Assembly (White)

Information & Images Provided by Bendix

Part Number	Description	Voltage	Watts	Comments
Bendix 800405 Meritor R955800405N	Purge Valve and Heater/ Thermostat Assembly Repair Kit (Replaces Bendix AD-9 purge valve and thermostat)	12 volt	n/a	Hard Seat

FOR BENDIX AD-IP

Bendix 109477X Meritor R955109477X	Remanufactured Air Dryer (Replaces Bendix AD-IP air dryer)	12 volt	n/a	
TRP® AC3001 Bendix 065624 Meritor R955065624N	Cartridge (Replaces Bendix AD-IP cartridge)	n/a	n/a	

FOR BENDIX AD-SP/ AD-IS

TRP® AC1001 Bendix 109994, 5008414, BR950011 Meritor R109994	Cartridge (Replaces Bendix AD-SP/ AD-IS cartridge) - also replaces Haldex 109994K and Wabco 432 410 222 7	n/a	n/a	
--	---	-----	-----	--

Air Dryer and Cartridges - Desiccant-style air dryers are like inline filters that remove both liquid and vapor from compressor discharge before it reaches the reservoir. As a result, only clean, dry air is supplied to the air system. This helps prevent freeze-ups and prolongs the life of air system components.



WABCO AIR DRYERS

Table 8-16: Wabco Air Dryers from Meritor

Part Number	Description	Related Part Numbers	Cartridge Part Number	Port Thread	Volts	Notes
R955205	Wabco System Saver 1200 Air Dryer Kit	New: SR-WABK118 Reman: SR-WABK118NX	R950011 R950068	Port 1 (supply): .50"-14 NPTF Port 21 (delivery): .50"-14 NPTF Port 4 (control): .25"-18 NPTF Port 22 (purge tank): .25"-18 NPTF	12 volt	System Saver 1000/1200: Production number 432 413 001 0 or 432 413 003 0
S400 850 701 0	Wabco System Saver 1200Plus Air Dryer Kit - <35 CFM rating	n/a	R950011 R950068	n/a	12 volt	System Saver 1200 Plus air dryer, retrofit kit for Bendix AD-9 air dryers: contains dryer, AD-9 mounting bracket adapter and installation instructions. Does not include the integrated governor.
S434 100 310 0	Wabco System Saver 1200 Air Dryer Repair Kit - 3-1/4" Length,	n/a	n/a	.50"-14 NPTF	n/a	Acts as a one-way check valve when pressure drops below 90 psi.

Information & Images Provided by Meritor

TROUBLESHOOTING TIPS FOR AIR DRYERS

TROUBLESHOOTING TIPS FOR AIR DRYERS

CONDITION	POSSIBLE CAUSE	SOLUTION
No regeneration cycle. No airflow from purge valve after initial purge blast (dryer decompression).	Air dryer not connected to supply tank or connections reversed at dryer. Regeneration valve not working. One-way check valve installed in supply tank. Alcohol evaporator installed between dryer and supply tank.	Verify proper dryer installation per system diagram. Replace regeneration valve. Remove one-way check valve. Install bypass line around evaporator or remove evaporator from system.
Air dryer purges too often, perhaps as frequently as every 15 seconds, accompanied by excessive cycling of the compressor.	Leak in line between governor and dryer port 4. Leak in line between supply tank and governor. Excessive air system leaks. Excessive air system demands. Outlet check valve not sealing. Regeneration valve not shutting off properly.	Repair air line. Repair air line. Repair leaks. Increase air system capacity or reduce air demand. Inspect and replace outlet check valve as needed. Replace regeneration valve.
Air dryer does not purge when compressor unloads (no blast of air from purge valve).	Air line between governor and air dryer port 4 kinked or plugged. Purge valve stuck closed. Air governor not working properly. Cut-out pressure never achieved by air compressor.	Repair air line. Replace purge valve. Inspect air governor. Repair/replace per manufacturer's instructions. Check for air leaks in system and repair as needed. If no leaks in system, check compressor output. Repair/replace per manufacturer's instructions.
Air flows out of purge valve entire time compressor is unloaded.	Turbo cut-off valve not sealing.	Replace turbo cut-off valve.
Rapid "spitting" of air from purge in small amounts. Frequency varies with engine speed.	Holset E-Type compressor used, but non-1200E dryer installed. Compressor not completely unloading when cut-out pressure is reached.	Replace air dryer with an SS1200E air dryer. Inspect compressor. Repair/replace per manufacturer's instructions.
Air leak at turbo cut-off valve vent. Hole burned in piston.	Temperature of air coming into dryer is too high - not enough cooling takes place before dryer inlet. Lip seal installed upside-down on piston. Lip must face UP (towards dryer). Valve bore worn excessively.	Move dryer farther from compressor. Add additional compressor discharge line before air dryer. Add cooling coil or heat exchanger before air dryer. NOTE : Inlet air temperature must not exceed 175°F. Install lip seal correctly. Inspect valve bore for wear. If a new turbo cut-off valve does not seal in a clean, lubricated bore, replace the air dryer.

Information & Images Provided by Meritor

CONDITION	POSSIBLE CAUSE	SOLUTION
Air dryer frozen (water collecting in base of dryer is freezing).	No electrical power to heater connector. Low voltage to heater connector. Heater assembly not working. Wrong voltage air dryer used, i.e. 12-volt air dryer used in a 24-volt system.	Check for a blown fuse. Repair heater circuit. NOTE: There must be power to the heater connector the entire time the vehicle's ignition is "on". Repair cause of low voltage, such as poor electrical ground, bad connections, corroded wire splices, etc.
No air pressure build-up in system.	Air dryer not plumbed correctly (connections are reversed). Wrong air line connected to dryer port 4. Air governor not working properly. Air system leaks, such as compressor discharge line, air dryer, reservoirs, brake or suspension valves, etc.	Ensure compressor discharge line is plumbed to air dryer port 1, and air dryer port 21 is connected to vehicle's supply tank. Ensure dryer port 4 line is connected to the "UNL" port of the air governor. Inspect governor per manufacturer's instructions.
Water in tanks; often following aftermarket installation or when dryer is a replacement for a competitive brand.	Pressure-controlled check valve not installed in correct tank or not installed at all. Pressure-controlled check valve properly installed, but one-way check valve not removed.	Install pressure-controlled check valve in secondary tank. Remove one-way check valve so that only the pressure-controlled check valve is installed between the secondary tank and supply tank.
Water, oil, or sludge in air system tanks.	Desiccant contaminated with oil. Holset E-type compressor used, but non-1200E dryer installed.	Replace desiccant. Inspect compressor per manufacturer's instructions. Replace air dryer with an SS1200E air dryer.
Water in system tanks, everything else checks out okay.	Dryer not suitable for application.	Review application guidelines. For assistance, call Meritor Customer Support Center at 1-800-535-5560.

Information & Images Provided by Meritor

AIR COMPRESSORS

REMANUFACTURED AIR COMPRESSORS (OIL-LUBED)

- For Caterpillar Engine
- Flange Mount (3304-3306 Flange)
- Water-cooled Head/ Air-cooled Block

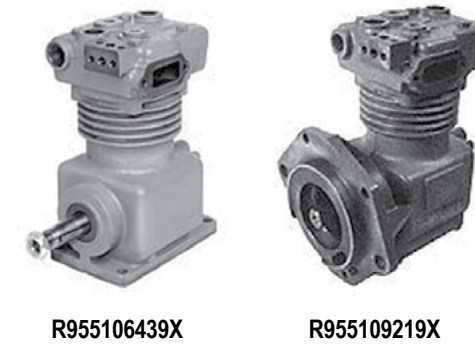


Table 8-17: Remanufactured Air Compressors (Replaces Bendix BX2150)

Part Number	Description	Port Location Inlet/ Outlet	Type of Discharge	Unloader Kit	Mounting Gasket Kit
Bendix 106439X Meritor R955106439X	Remanufactured Air Compressor (Replaces Bendix BX2150)	Left/Optional	Threaded	R955104012	R955153102
Bendix 109219X Meritor R955109219X	Remanufactured Air Compressor - for Caterpillar Engine (Replaces Bendix BX2150)	Left/Top	Threaded	R955279615N	R955153106

Information & Images Provided by Bendix

REMANUFACTURED AIR COMPRESSORS (OIL-LUBED)

- Splined and Tapered Shaft
- Flange Mount (3406B-3176 Flange)
- Water-cooled Head/ Air-cooled Block

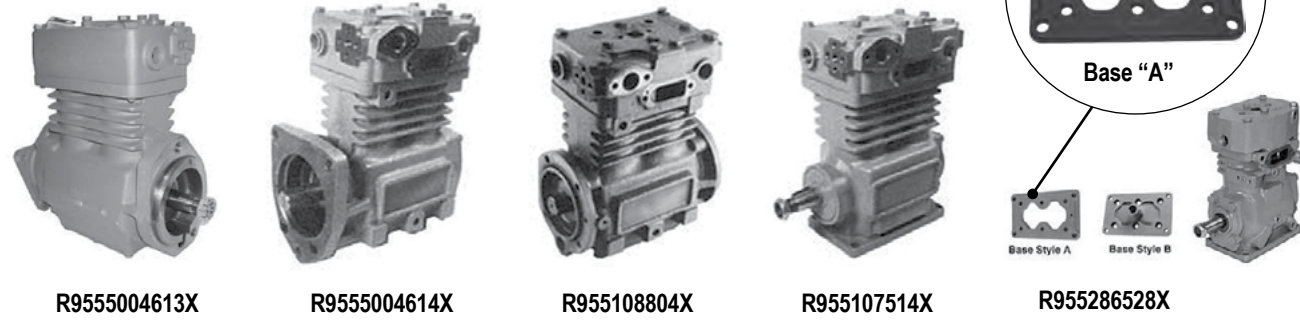


Table 8-18: Remanufactured Air Compressors (Replaces Bendix TU-FLO)

Part Number	Description	Port Location Inlet/ Outlet	Type of Discharge	Unloader Kit	Mounting Gasket Kit	Notes
Bendix 286528X Meritor R955286528X	Remanufactured Air Compressor - Base Style - A (Replaces Bendix TU-FLO 501)	Left/Top	Threaded	R955279615N	R955280511N	
Bendix 107514X Meritor R955107514X	Remanufactured Air Compressor (Replaces Bendix TU-FLO 550)	Left/Top	Threaded	R955153150	R955280511N	
Bendix 108110X Meritor R955108110X	Remanufactured Air Compressor (Replaces Bendix TU-FLO 550)	Left/Top	Threaded	R955153150	R955280511N	Two Mounting Studs
Bendix 108804X Meritor R955108804X	Remanufactured Air Compressor - for Cummins Engine (Replaces Bendix TU-FLO 550/ 750)	Top/Left	Optional	R955153150	R955153108	New Style Head Cummins ISB & C - 37 tooth gear
Bendix 5004613X Meritor R9555004613X	Remanufactured Air Compressor - for International Engines (Replaces Bendix TU-FLO 550)	Right/Left	Optional	R955153150	R955153112	International I6 (Pre-2004) DT466, HT530
Bendix 5004614X Meritor R9555004614X	Remanufactured Air Compressor - for International Engines (Replaces Bendix TU-FLO 750)	Right/Left	n/a	n/a	n/a	International I6 (Pre-2004) HT530

Information & Images Provided by Meritor

AIR GOVERNORS



D-2 AIR GOVERNORS FROM BENDIX

Table 8-19: D-2 Air Governors from Bendix

Part Number	Description	Reman Part Number	Pressure Range	Comments
065018	Bendix D-2® Air Governor	n/a	100-120 psi	Non-Adjustable
275200N	Bendix D-2® Air Governor	n/a	90-105 psi	
275491N	Bendix D-2® Air Governor	275491RX	100-120 psi	
275508N	Bendix D-2® Air Governor	n/a	95-110 psi	
275530N	Bendix D-2® Air Governor	n/a	120-150 psi	
275707N	Bendix D-2® Air Governor	275707RX	105-125 psi	
277486N	Bendix D-2® Air Governor	n/a	110-130 psi	
283657N	Bendix D-2® Air Governor	n/a	115-135 psi	
284358N	Bendix D-2® Air Governor	284358RX	105-125 psi	Governor supplied with high temperature o-rings and waterproof cover.
800361N	Bendix D-2® Air Governor	n/a	105-130 psi	Non-Adjustable



D-2 AIR GOVERNORS MAINTENANCE KIT FROM BENDIX

Table 8-20: D-2 Air Governors Maintenance Kit from Bendix

Part Number	Description
280915	Bendix D-2® Air Governor Maintenance Kit With High Temperature O-Rings
276121N	Bendix D-2® Air Governor Maintenance Kit With Standard O-Rings
5007834	Bendix D-2® Air Governor Mounting Gasket
5004049	Bendix D-2® Air Governor Check Valve Kit

Information & Images Provided by Bendix



ADDITIONAL AIR GOVERNORS

Table 8-21: Additional Air Governors

Part Number	Description	Cut-In	Cut-Out	Port Size	Application & General Information
Bendix 275491 Meritor R955275491N	Air Governor (Replaces Bendix D-2)	100 psi	120 psi	1/8"	Standard Version. Pressure setting range is adjustable. Governor - Signals the unloading mechanism on the compressor when to build up air to the reservoir and when to halt air build up. Usually between 100 and 120 psi. Includes gasket and also plugs for
Meritor R955KN18530X	Remanufactured Midland Standard Air Governor (Replaces Midland KN18530X)	100 psi	120 psi	1/8"	Governor - Signals the unloading mechanism on the compressor when to build up air to the reservoir and when to halt air build up. Usually between 100 and 120 psi.

Information & Images Provided by Bendix

BRAKE VALVES



For Air Dryers See pg. 8-12.



E-8P & E-10P BRAKE VALVES FROM BENDIX

Table 8-22: E-8P & E-10P Brake Valves from Bendix

Part Number	Description	Comments
800629	Bendix E-8P® Brake Valve	Lower Body Rotated 90°
800630	Bendix E-8P® Brake Valve	Lower Body Rotated 90°
800631	Bendix E-8P® Brake Valve	1/2" NPT Exhaust
802924	Bendix E-8P® Brake Valve	High Temp
800599	Bendix E-8P® Brake Valve	PTC (Push to Connect) Fittings
800632	Bendix E-10P™ Brake Valve	Replaces E-15™ Brake Valve 65315, 800318
287368N	Bendix E-8P®, E-10P™ & E-10PR™ Dual Brake Valves Minor Repair Kit	
289335	Bendix E-8P®, E-10P™ & E-10PR™ Dual Brake Valves Major Repair Kit	



Table 8-23: Dual Brake Foot Valves from Bendix

Part Number	Description	Comments
286171N	Bendix E-6® Dual Foot Valve (Basic)	286171RX
802911	Bendix E-6® Dual Foot Valve (Basic)	High Temp
287368N	Bendix E-6® Dual Foot Valve (Basic) Minor Repair Kit	Treadle and Mounting Plate not Included.

Information & Images Provided by Bendix

Part Number	Description	Comments
5019319	Bendix E-6® Dual Foot Valve (Basic) Minor Repair Kit - High Temp	Treadle and Mounting Plate not Included.
289335	Bendix E-6® Dual Foot Valve (Basic) Major Repair Kit	Treadle and Mounting Plate not Included.

BRAKE VALVES

- Dual Foot Valve - A dual foot valve has two separate circuits for service and secondary braking, and is used in dual circuit air brake systems mandated by FMVSS-121.
- Braking ability is maintained in the event that one circuit fails .
- All supply and delivery ports are 3/8" PT.
- Two supply ports are serviced from the number 1 reservoir and 2 are serviced by the number 2 reservoir.
- Two delivery ports actuate the primary circuit and 2 actuate the secondary circuit.
- The E-S is a floor-mounted treadle operated valve with two separate supply and delivery circuits.



Table 8-24: Additional Dual Brake Foot Valves

Part Number	Description	Supply Port	Supply Port Mount Side	Exhaust Port	Delivery Port	Delivery Port Mount Side	Comments
Bendix 286171 Meritor R955286171N	Dual Foot Valve (Dual Circuit) (Replaces Bendix E-6®)	3/8" (4)	n/a	n/a	3/8" (4)	n/a	Kit does not contain treadle and mounting brackets.
Bendix 286171 Meritor R955286171	Dual Foot Valve (Dual Circuit) (Replaces Bendix E-6® or Wabco)	3/8" (4)	n/a	n/a	3/8" (4)	n/a	Kit does not contain treadle and mounting brackets.
Bendix 286171X Meritor R955286171X	Remanufactured Dual Foot Valve (Dual Circuit) (Replaces Bendix E-6®)	3/8" (4)	n/a	n/a	3/8" (4)	n/a	Kit does not contain treadle and mounting brackets.
Bendix 101818 Meritor R955101818N	Dual Foot Valve (Dual Circuit) (Replaces Bendix E-7®)	1/4" (4)	1/2" (2) 1/8" (1)	Diaphragm	3/8" (4)	1/2" (2)	Kit does not contain treadle and mounting brackets.
Bendix 101818 Meritor R955101818	Dual Foot Valve (Dual Circuit) (Replaces Bendix E-7® or Wabco)	1/4" (4)	1/2" (2) 1/8" (1)	Diaphragm	3/8" (4)	1/2" (2)	Kit does not contain treadle and mounting brackets.

Information & Images Provided by Meritor

Part Number	Description	Supply Port	Supply Port Mount Side	Exhaust Port	Delivery Port	Delivery Port Mount Side	Comments
Bendix 101818X Meritor R955101818X	Remanufactured Dual Foot Valve (Dual Circuit) (Replaces Bendix E-7®)	1/4" (4)	1/2" (2) 1/8" (1)	Diaphragm	3/8" (4)	1/2" (2)	Kit does not contain treadle and mounting brackets.
Bendix 800629 Meritor R955800629N	Dual Foot Valve (Dual Circuit) (Replaces Bendix E-12®)	n/a	n/a	n/a	3/8"-18	n/a	Kit does not contain treadle and mounting brackets.

Information & Images Provided by Meritor

BRAKE VALVES - ACTUATORS



BVA-85 BRAKE VALVE ACTUATORS FROM BENDIX

Table 8-25: BVA-85 Brake Valve Actuators from Bendix

Part Number	Description	Comments
5009593	Bendix BVA-85™ Brake Valve Actuator	1-4" PTC Port
5009594	Bendix BVA-85™ Brake Valve Actuator	1/4" NPT Port
K039060	Bendix BVA-85™ Brake Valve Actuator	1/4" NPT Port - High Temp.

Information & Images Provided by Bendix

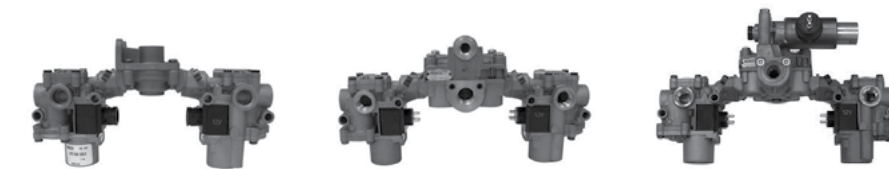
BRAKE VALVES - PACKAGES

For Air Governors See pg. 8-19.



ABS VALVE PACKAGES FROM MERITOR

- Provides an alternative to separate valve installation by combining a quick release valve with two ABS modulator valves.
- This valve package is compatible with C-, D- and E-Version ECUs.
- Replacement kits contain valve, bolts, o-rings and lubricant.
- NOTE: Quick Release Valve and Modulator Valves can be serviced separately.



472 500 320 0

472 500 120 0

472 500 220 0

Table 8-26: ABS Valve Package (Front Axle) from Meritor

Part Number	Description	Crack Pressure	Voltage	ABS configuration	Valves to be Replaced	Replacement Kit Part Number	Reman Part Number
472 500 320 0	Tractor/School Bus ABS Valve Package (Front Axle)	1.0 psi	12 volts	Bayonet-style connector	Entire Valve Package	S472 500 320 0	n/a
					ABS modulator valve 472 195 076 0	S472 195 076 0	n/a
					472 195 077 0	S472 195 077 0	n/a
					Relay valve 973 011 021 0	R950058	R950058NX
Replacement kit 472 500 100 0	R955412	n/a					
472 500 120 0	Tractor/School Bus ABS Valve Package (Rear Axle)	4.0 psi	12 volts	4S/ 4M Bayonet-style connector	Entire Valve Package	S472 500 120 0	n/a
					ABS modulator valve 472 195 076 0	R955353	R955353NX
					472 195 077 0	R955354	R955354NX
					Relay valve 973 011 021 0	S472 500 006 2	S472 500 006 7
Replacement kit 472 500 100 0	R955410	n/a					
472 500 220 0	Tractor/School Bus ABS/ ATC Valve Package (Rear Axle)	4.0 psi	12 volts	4S/ 4M Bayonet-style connector	Entire Valve Package	S472 500 220 0	n/a
					ABS modulator valve: 472 195 076 0	R955353	n/a
					472 195 077 0	R955354	n/a
					Relay valve: 973 011 021 0	S973 011 920 2	n/a
Replacement kit: 472 500 100 0	S472 170 797 0	n/a					

* All part tags consist of 1 part number and 1 assembly part number. Be sure to verify part number before selecting a product.

Information & Images Provided by Meritor

CHECK VALVES - SINGLE



SINGLE CHECK VALVES FROM BENDIX

- SC-3™ valves replace both the SC-1™ and SC-2™ valves

Table 8-27: Single Check Valves from Bendix

Part Number	Description	Inlet A	Outlet B
SINGLE CHECK VALVES - FEMALE INLET/ FEMALE OUTLET			
801144	Bendix Single Check Valve - Straight - Female Inlet/ Female Outlet	1/4"	1/4"
800370	Bendix Single Check Valve - Straight - Female Inlet/ Female Outlet	1/2"	1/2"
800369	Bendix Single Check Valve - Straight - Female Inlet/ Female Outlet	3/4"	3/4"

SINGLE CHECK VALVES - FEMALE INLET/ MALE OUTLET

800376	Bendix Single Check Valve - Elbow - Female inlet - Male outlet	1/2"	1/2"
800374	Bendix Single Check Valve - Straight - Female Inlet/ Male Outlet	1/4"	1/8"
800375	Bendix Single Check Valve - Straight - Female Inlet/ Male Outlet	1/4"	1/4"
800373	Bendix Single Check Valve - Straight - Female Inlet/ Male Outlet	3/8"	3/8"
800372	Bendix Single Check Valve - Straight - Female Inlet/ Male Outlet	1/2"	1/2"



ADDITIONAL SINGLE CHECK VALVES

Table 8-28: Additional Single Check Valves

Part Number	Description	Port Size	Length	Comments
R955KN23010N	Midland Single Check Valve - Heavy Duty (Replaces Midland KN23010)	3/8"	2-15/32"	Heavy Duty
R955KN23000N	Midland Single Check Valve - Heavy Duty (Replaces Midland KN23000)	1/2"	2-15/32"	Heavy Duty

CHECK VALVES - DOUBLE



DOUBLE CHECK VALVES FROM BENDIX

Table 8-29: Double Check Valves from Bendix

Part Number	Description	Pipe Thread Dimension A	Pipe Thread Dimension B	Pipe Thread Dimension C	Pipe Thread Dimension D
278614N	Bendix Double Check Valve - 3 port	3/8"	3/8"	3/8"	
278615N	Bendix Double Check Valve - 3 port	1/4"	1/4"	1/4"	
278595N	Bendix Double Check Valve - 4 port	1/4"	1/4"	1/2"	1/4"
278596N	Bendix Double Check Valve - 4 port	3/8"	3/8"	1/2"	1/4"
278597N	Bendix Double Check Valve - 4 port	1/4"	1/4"	3/8"	1/4"
278598N	Bendix Double Check Valve - 4 port	3/8"	3/8"	3/8"	1/4"
280809N	Bendix Double Check Valve - 4 port	3/8"	3/8"	3/8"	3/8"



ADDITIONAL DOUBLE CHECK VALVES

Table 8-30: Additional Double Check Valves

Part Number	Description	Port Size	Comments
RKN25060	Double Check Valve (Replaces Midland KN25060)	Inlet B, D: 3/8" F Outlet C: 3/8" F	Can be used in place of ball or shuttle types. Improves FMVSS-121 systems. Not position sensitive, may be mounted in any position. Used when two inputs must become one output. Weight 0.3 lbs.
Bendix 278614 Meritor R955278614N	Double Check Valve (Replaces Bendix DC-4)	(3) 3/8"	DC-4 Double Check Valve - Accepts a signal from two sources and delivers it to a common outlet; Normally used with a trailer control and foot valve where delivery pressure from either source, but not both controls the brake
R955KN23000N	Double Check Valve - Heavy Duty (Replaces Bendix DC-4, Midland KN23000)	1/2"	Heavy Duty
R955KN23010N	Double Check Valve - Heavy Duty (Replaces Bendix DC-4, Midland KN23010)	3/8"	Heavy Duty

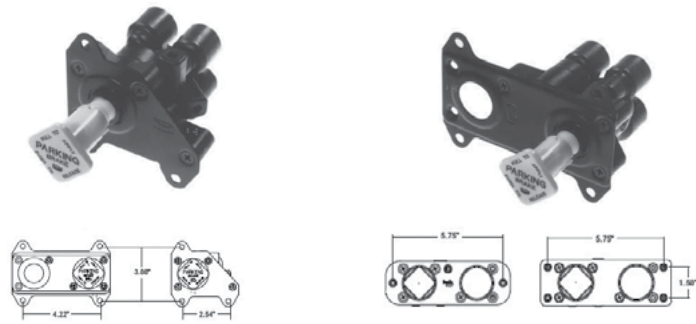
CONTROL VALVES



PP-1 CONTROL VALVES FROM BENDIX

Table 8-31: PP-1 Control Valves from Bendix

Part Number	Description	Reman Part Number	Automatic Release Pressure	Delivery Port	Comments
276566N	Bendix PP-1® Control Valve	276566RX	20 psi	1/8"	
276567N	Bendix PP-1® Control Valve	276567RX	40 psi	1/8"	
278450N	Bendix PP-1® Control Valve	278450RX	n/a	1/8"	
281587N	Bendix PP-1® Control Valve	281587RX	40 psi	1/8"	Remote controlled
283828N	Bendix PP-1® Control Valve	283828RX	60 psi	1/8"	
287417N	Bendix PP-1® Control Valve	287417RX	30 psi	1/4"	
287600N	Bendix PP-1® Control Valve	287600RX	40 psi	1/4"	
281126N	Bendix PP-1® Control Valve Maintenance Kit	n/a	n/a	n/a	



PP-DC CONTROL VALVES FROM BENDIX

Table 8-32: PP-DC Control Valves from Bendix

Part Number	Description	Cover View	Mounting Holes	Port Type	Comments
065643	Bendix PP-DC® Control Valve	2	.27" Dia.	3/8" PTC	PTC - Push To Connect Fittings
065661	Bendix PP-DC® Control Valve	1	1/4-20 Thread	3/8" PTC	PTC - Push To Connect Fittings
065690	Bendix PP-DC® Control Valve	1	.27" Dia.	3/8" PTC	PTC - Push To Connect Fittings
800034	Bendix PP-DC® Control Valve	2	.27" Dia.	1/4" NPT	
800142	Bendix PP-DC® Control Valve	1	1/4-20 Thread	1/4" NPT	
800309	Bendix PP-DC® Control Valve	3	M6 x 1-6H	3/8" PTC	PTC - Push To Connect Fittings
800620	Bendix PP-DC® Control Valve	4	M8 x 1-6H	3/8" PTC	PTC - Push To Connect Fittings
800841	Bendix PP-DC® Control Valve	2	M6 x 1-6H	3/8" PTC	PTC - Push To Connect Fittings
801315	Bendix PP-DC® Control Valve	2	.27" Dia.	3/8" PTC Elbow	PTC - Push To Connect Fittings
5006939	Bendix PP-DC® Control Valve Maintenance Kit	n/a	n/a	n/a	

Information & Images Provided by Bendix

ADDITIONAL CONTROL VALVES

- Push Pull Valve
- Manually operable
- Pressure sensitive
- On/off valves automatically return to the button out (exhaust) position when supply pressure is below the required minimum

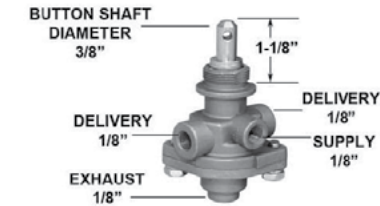


Table 8-33: Additional Control Valves

Part Number	Description	Auto Release Pressure	Delivery Port	Comments
Bendix 276567 Meritor R955276567N	Control Valve (Replaces Bendix PP-1)	40 psi	1/8"	Button and mounting nut not included.
Bendix 276567X Meritor R955276567X	Remanufactured Control Valve (Replaces Bendix PP-1)	40 psi	1/8"	Button and mounting nut not included.

- Controls parking/emergency brakes
- Direct replacement for the PP-1
- All ports 1/8"-27 NPTF
- Bulkhead mount - 7/8" mounting hole required
- Made of durable EGC (Engineering Grade Composite) & will not rust or corrode
- Weight 0.4 lb

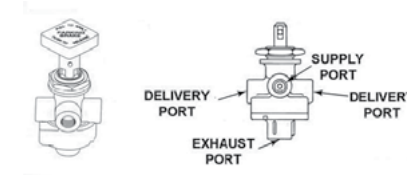


Table 8-34: Control Valves from Meritor

Part Number	Description	Pop Pressure	Knob Part Number
RKN20021	Park (Control) Brake Valve (1 Knob) (Replaces Midland KN20021)	35 +/- 10 psi	RKN20903

Information & Images Provided by Meritor

MODULATING VALVES



MODULATING VALVES FROM BENDIX

Table 8-35: R-7 Modulating Valves from Bendix

Part Number	Description	Reman Part Number	Spring Brake Release Pressure
103081N	Bendix R-7™ Modulating Valve	103081RX	95 psi
283861	Bendix R-7™ Modulating Valve Maintenance Kit	n/a	n/a

Information & Images Provided by Bendix

PRESSURE PROTECTION VALVES

PRESSURE PROTECTION VALVES FROM BENDIX

- Adjustable Pressure Setting



Table 8-36: PR-2 Pressure Protection Valves from Bendix

Part Number	Description	Reman Part Number	Nominal Closing Pressure (P.S.I.)	Comments
277147N	Bendix PR-2™ Pressure Protection Valve	277147RX	65 psi	
277148N	Bendix PR-2™ Pressure Protection Valve	277148RX	85 psi	
277222N	Bendix PR-2™ Pressure Protection Valve	n/a	95 psi	
277226N	Bendix PR-2™ Pressure Protection Valve	277226RX	60 psi	
277227N	Bendix PR-2™ Pressure Protection Valve	n/a	75 psi	
279505N	Bendix PR-2™ Pressure Protection Valve	n/a	65 psi	with lockwire
281467N	Bendix PR-2™ Pressure Protection Valve	n/a	50 psi	
282517N	Bendix PR-2™ Pressure Protection Valve	n/a	60 psi	with lockwire

- Fixed Pressure Setting



Table 8-37: PR-4 Pressure Protection Valves from Bendix

Part Number	Description	Reman Part Number	Nominal Closing Pressure (P.S.I.)	Supplies & Delivery Ports	Comments
286500N	Bendix PR-4™ Pressure Protection Valve	286500RX	85 psi	1/4"	
288323N	Bendix PR-4™ Pressure Protection Valve	288323RX	70 psi	1/4"	
287366	Bendix PR-4™ Pressure Protection Valve - Maintenance Kit	n/a	n/a	n/a	Not for use with Part Number 103976N

Information & Images Provided by Bendix

ADDITIONAL PRESSURE PROTECTION VALVES

- Pressure Protection Valves:
- Protects the brake system from accessory failure
- Used to isolate and protect one reservoir supply from another by closing at its pressure setting.
- Also used in rapid buildup systems where it delays the filling of auxiliary reservoirs until a preset pressure is reached in the primary reservoir.
- Pressure Setting on the PR-2 is adjustable.



R955277147N



R955KN31000X

Table 8-38: Additional Pressure Protection Valves

Part Number	Description	Crack Pressure	Crack Pressure - Closed	Accessory Port - B	Accessory Port - C
Bendix 277147 Meritor R955277147N	Pressure Protection Valve (Replaces Bendix or Midland PR-2)	65 psi	n/a	n/a	n/a
R955KN31000X	Remanufactured Pressure Protection Valve (Replaces Midland KN31000X)	65 psi	45 psi	1/4"	1/4"

QUICK RELEASE VALVES

QUICK RELEASE VALVES FROM BENDIX



Table 8-39: QR-1 Quick Release Valves from Bendix

Part Number	Description	Reman Part Number	Supply Port	Delivery Port	Crack Pressure	Comments
229813N	Bendix QR-1® Quick Release Valve	229813RX	3/8"	1/4"	0 psi	
229844N	Bendix QR-1® Quick Release Valve	229844RX	1/2"	1/4"	0 psi	
229859N	Bendix QR-1® Quick Release Valve	229859RX	3/8"	3/8"	0 psi	
229860N	Bendix QR-1® Quick Release Valve	229860RX	1/2"	3/8"	0 psi	
281024N	Bendix QR-1® Quick Release Valve	281024RX	1/4"	1/4"	0 psi	
288251N	Bendix QR-1® Quick Release Valve	288251RX	3/8"	3/8"	0 psi	3/8" PT Exhaust
278483N	Bendix QR-1® Quick Release Valve	278483RX	1/2"	3/8"	5-8 psi	
102344N	Bendix QR-1® Quick Release Valve	n/a	3/8"	3/8"	10-16 psi	
289042N	Bendix QR-1® Quick Release Valve	289525RX	3/8"	1/4"	1 psi max	with insert
289525N	Bendix QR-1® Quick Release Valve	289525RX	3/8"	3/8"	1 psi max	with insert
260519	Bendix QR-1® Quick Release Valve Maintenance Kit	n/a	n/a	n/a	n/a	kit for conversion of 0 psi crack pressure valves to 1 psi



Table 8-40: QRN Quick Release Valves from Bendix

Part Number	Description	Supply Port	Delivery Port	Crack Pressure	Mounting Details
802745	Bendix QRN™ Quick Release Valve	1/2"	3/8"	1 psi max	.34" holes
802743	Bendix QRN™ Quick Release Valve	3/8"	3/8"	1 psi max	.34" holes
802741	Bendix QRN™ Quick Release Valve	3/8"	3/8"	5-8 psi	.34" holes
802744	Bendix QRN™ Quick Release Valve	3/8"	3/8"	1 psi max	.34" x .75" slots

Information & Images Provided by Bendix

Part Number	Description	Supply Port	Delivery Port	Crack Pressure	Mounting Details
065213	Bendix QRN™ Quick Release Valve	3/8"	3/8"	4.5-7.5 psi	.34" x .75" slots
065214	Bendix QRN™ Quick Release Valve	3/8"	3/8"	2-4.5 psi	.34" x .75" slots
802742	Bendix QRN™ Quick Release Valve	1/2"	3/8"	5-8 psi	.34" holes
065311	Bendix QRN™ Quick Release Valve	1/2"	3/8"	4.5-7.5 psi	.34" x .75" slots
065347	Bendix QRN™ Quick Release Valve	1/2"	3/8"	2-4.5 psi	.34" x .75" slots
800439	Bendix QRN™ Quick Release Valve	1/2"	3/8"	2-4.5 psi	n/a
104463	Bendix QRN™ Quick Release Valve Maintenance Kit	n/a	n/a	n/a	n/a

- The QRN-2™ quick release valve is a lightweight, nonmetallic quick release valve.



Table 8-41: QRN-2 Quick Release Valves from Bendix

Part Number	Description	Supply Port	Delivery Port	Crack Pressure	Comments
800063	Bendix QRN-2™ Quick Release Valve	1/2" NPT	3/8" NPT	0 psi	
800064	Bendix QRN-2™ Quick Release Valve	3/8" NPT	3/8" NPT	0 psi	
800219	Bendix QRN-2™ Quick Release Valve	1/2" PTC	1/2" PTC	0 psi	PTC - Push To Connect Fittings

Information & Images Provided by Bendix

ADDITIONAL QUICK RELEASE VALVES

- Quick Release Valve meets FMVSS-121 timing requirements.
- Corrosion and weather resistant.
- Used wherever a quick release function is required in the air brake system.
- Made of durable EGC (Engineering Grade Composite).
- Utilizes an oil-resistant diaphragm for longer life.
- Weight: 0.31 lb.

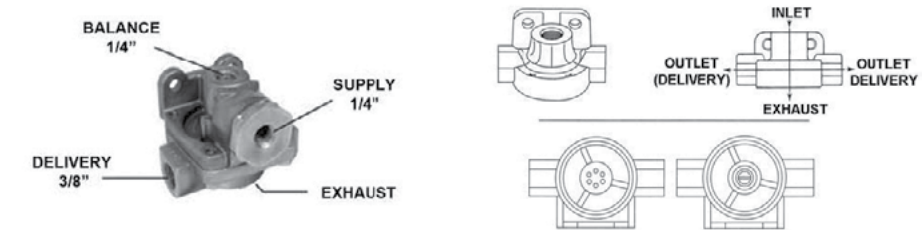


Table 8-42: Additional Quick Release Valves

Part Number	Description	Inlet Port	Outlet Port	Differential psi
Bendix 289714 Meritor R955289714N	Quick Release Valve (with double check valve) (Replaces Bendix QR-1C)	1/2"	3/8"	1 psi
Bendix 289714X Meritor R955289714X	Remanufactured Quick Release Valve (with double check valve) (Replaces Bendix QR-1C)	1/2"	3/8"	1 psi
RKN3211	Midland Quick Release Valve (Replaces Midland KN32011)	1/2"	3/8"	0 psi

RELAY VALVES

RELAY VALVES (VERTICAL PORTS) FROM BENDIX

- Available Remanufactured Exchange
- All Universal R-12® and R-14® Relay Valves Include Installation Instructions and a Universal Mounting Bracket as indicated.



Table 8-43: Relay Valves (Vertical Ports) from Bendix

Part Number	Description	Reman Part Number	Crack Pressure	Delivery Port	Maintenance Kit	Mounting Bracket	Comments
065104	Bendix R-12® Relay Valve - Vertical Delivery Ports	5003365X	4 psi	3/8"	102802N	296010N	
065181	Bendix R-12® Relay Valve - Vertical Delivery Ports	n/a	5.5 psi	1/2"	102802N	296010N	
102626N	Bendix R-12® Relay Valve - Vertical Delivery Ports	102626RX	4 psi	1/2"	102802N	296010N	
103912	Bendix R-12® Relay Valve - Vertical Delivery Ports	103912RX	7.5 psi	1/2"	102802N	296010N	
	Bendix R-12® Relay Valve - Vertical Delivery Ports	104561RX	5.5 psi	3/8"	102802N	296010N	
800365	Bendix R-12® Relay Valve - Vertical Delivery Ports	n/a	4 psi	3/8"	102802N	296010N	Self-draining piston

Information & Images Provided by Bendix

RELAY VALVES (HORIZONTAL PORTS) FROM BENDIX

- Available Remanufactured Exchange
- All Universal R-12® and R-14® Relay Valves Include Installation Instructions and a Universal Mounting Bracket as indicated.



Table 8-44: HR-1 Relay Valves from Bendix

Part Number	Description	Exhaust Port	Supply Port	Push/ Pull Delivery	Reservoir Port	Control Port	Delivery Port	Application
065147	Bendix HR-1™ Hydraulic Relay Valve	7/8" UNF	9/16" UNF	7/16" UNF	7/16" UNF	7/16" UNF	7/8" UNF	Ford, Navistar

Information & Images Provided by Bendix



Table 8-45: Relay Valves (Horizontal Ports) from Bendix

Part Number	Description	Reman Part Number	Crack Pressure	Supply Port	Delivery Port	Maintenance Kit	Mounting Bracket	Comments
065125	Bendix R-12® Relay Valve - Horizontal Delivery Ports	n/a	5.5 psi	1/2"	1/2"	102802N	296010N	
065309	Bendix R-12® Relay Valve - Horizontal Delivery Ports	n/a	4 psi	1/2"	1/2"	102802N	296010N	
065546	Bendix R-12® Relay Valve - Horizontal Delivery Ports	n/a	4 psi	1/2"	1/2"	109523	296010N	
103009N	Bendix R-12® Relay Valve - Horizontal Delivery Ports	103009RX	4 psi	3/4"	1/2"	102802N	296010N	
	Bendix R-12® Relay Valve - Horizontal Delivery Ports	104165RX	7.5 psi	3/4"	1/2"	102802N	296010N	
800238	Bendix R-12® Relay Valve - Horizontal Delivery Ports	n/a	4 psi	3/4"	1/2"	102802N	n/a	
800305	Bendix R-12® Relay Valve - Horizontal Delivery Ports	n/a	4 psi	1/2"	1/2"	5002831	296010N	
800366	Bendix R-12® Relay Valve - Horizontal Delivery Ports	n/a	5.5 psi	1/2"	3/8"	5004029	296010N	Self-draining piston
800365	Bendix R-12® Relay Valve - Horizontal Delivery Ports	n/a	4 psi	1/2"	1/2"	5004029	296010N	Self-draining piston

RELAY VALVES (VERTICAL AND HORIZONTAL PORTS) FROM BENDIX

- Available Remanufactured Exchange
- All Universal R-12® and R-14® Relay Valves Include Installation Instructions and a Universal Mounting Bracket as indicated.



Table 8-46: Relay Valves (Vertical and Horizontal Ports) from Bendix

Part Number	Description	Crack Pressure	Delivery Port	Maintenance Kit	Mounting Bracket	Comments
065206	Bendix R-12® Relay Valve - Two Vertical & Two Horizontal Delivery Ports	5.5 psi	3/8"	102802N	296010N	
065303	Bendix R-12® Relay Valve - Two Vertical & Two Horizontal Delivery Ports	4 psi	3/8"	102802N	296010N	
800095	Bendix R-12® Relay Valve - Two Vertical & Two Horizontal Delivery Ports	4 psi	3/8"	102802N	102846N	Mounting bracket 102846N includes two 5/16" mounting studs.
800441	Bendix R-12® Relay Valve - Two Vertical & Two Horizontal Delivery Ports	5.5 psi	3/8"	102802N	102846N	Mounting bracket 102846N includes two 5/16" mounting studs.
800483	Bendix R-12® Relay Valve - Two Vertical & Two Horizontal Delivery Ports	5.5 psi	1/2"	102802N	n/a	
800484	Bendix R-12® Relay Valve - Two Vertical & Two Horizontal Delivery Ports	5.5 psi	1/2"	102802N	296010N	
800485	Bendix R-12® Relay Valve - Two Vertical & Two Horizontal Delivery Ports	4 psi	1/2"	102802N	n/a	
800486	Bendix R-12® Relay Valve - Two Vertical & Two Horizontal Delivery Ports	4 psi	1/2"	102802N	296010N	
800508	Bendix R-12® Relay Valve - Two Vertical & Two Horizontal Delivery Ports	5.5 psi	1/2"	102802N	n/a	
296010N	Bendix R-12® Relay Valve - Universal Mounting Bracket	n/a	n/a	n/a	n/a	

Information & Images Provided by Bendix

RELAY VALVES (MAINTENANCE KITS) FROM BENDIX

- Available Remanufactured Exchange
- All Universal R-12® and R-14® Relay Valves Include Installation Instructions and a Universal Mounting Bracket as indicated.

Table 8-47: Relay Valves (Maintenance Kits) from Bendix

Part Number	Description
102846N	Bendix R-12® Relay Valve - Mounting Bracket with two 5-16" mounting studs
102802N	Bendix R-12® Relay Valve - Field Maintenance Kit for R-12® and R-14® Relay Valves
109523	Bendix R-12® Relay Valve - Maintenance Kit
5002831	Bendix R-12® Relay Valve - Maintenance Kit
5004029	Bendix R-12® Relay Valve - Maintenance Kit

ADDITIONAL RELAY VALVES

- Two 1/2" PT delivery ports located on the side of the valve.
- One 1/4" PT service port.
- Two 3/4" PT supply ports.
- One 1/8" PT balance port located under the exhaust cover.
- The balance port provides an anti-compounding feature that prevents simultaneous application of the service and parking sides of the spring brake and allows the valve to control spring brakes and service brakes.
- Universal mounting bracket R955153200 supplied with all R-14 relay valves.

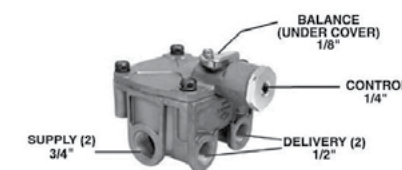


Table 8-48: Additional Relay Valves

Part Number	Description	Crack Pressure
Bendix 103010 Meritor R955103010N	Relay Valve (Horizontal) (Replaces Bendix R-14H)	4.0 psi
Bendix 103010X Meritor R955103010X	Remanufactured Relay Valve (Horizontal) (Replaces Bendix R-14H)	4.0 psi

Information & Images Provided by Bendix

SAFETY VALVES



SAFETY VALVES FROM BENDIX

Table 8-49: ST-3 Safety Valves from Bendix

Part Number	Description	Pipe Thread	Pressure Setting
284142	Bendix ST-3™ Safety Valves	1/4"	150 psi
284143	Bendix ST-3™ Safety Valves	3/8"	150 psi
285849	Bendix ST-3™ Safety Valves	1/4"	175 psi
285850	Bendix ST-3™ Safety Valves	1/4"	75 psi

Information & Images Provided by Bendix

SPRING BRAKE VALVES

SPRING BRAKE VALVES FROM BENDIX

- Available Remanufactured Exchange



Table 8-50: Bendix SR-1 Spring Brake Valves

Part Number	Description	Reman Part Number	Reservoir Trip Pressure	Customer Identification
286364N	Bendix SR-1™ Spring Brake Valve	286364RX	55 psi	None
288063N	Bendix SR-1™ Spring Brake Valve	288063RX	30 psi	International IHC-459271-C92
108123	Bendix SR-1™ Spring Brake Valve Maintenance Kit	n/a	n/a	n/a



Table 8-51: Bendix SR-7 Spring Brake Valves

Part Number	Description	Mounting Stud Thread	Length	Control Port Size	Fitting	Balance Port Size	Fitting	Comments
K021557	Bendix SR-7® Spring Brake Modulating Valve	3/8"-16	.94"	1/4" NPT	n/a	1/4" NPT	n/a	
K021558	Bendix SR-7® Spring Brake Modulating Valve	3/8"-16	.94"	3/8" PTC	Straight	3/8" PTC	Straight	PTC - Push To Connect Fittings
K021559	Bendix SR-7® Spring Brake Modulating Valve	3/8"-16	.94"	3/8" PTC	90°	3/8" PTC	Straight	PTC - Push To Connect Fittings
K021560	Bendix SR-7® Spring Brake Modulating Valve	M10	1.38"	3/8" PTC	90°	3/8" PTC	90°	PTC - Push To Connect Fittings
K021562	Bendix SR-7® Spring Brake Modulating Valve	n/a	n/a	1/4" NPT	n/a	1/4" NPT	n/a	
K021563	Bendix SR-7® Spring Brake Modulating Valve	n/a	n/a	3/8" PTC	Straight	3/8" PTC	Straight	PTC - Push To Connect Fittings

Information & Images Provided by Bendix

ADDITIONAL SPRING BRAKE VALVES

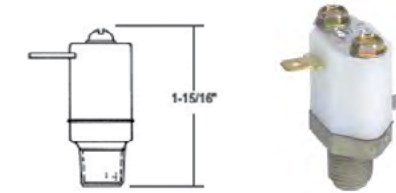
- The SR-1 is normally used on trucks and tractors with dual air brake systems.
- Parking functions are also controlled through the SR-1.
- One 1/4" PT delivery port.
- One 1/4" PT reservoir port.
- One 1/4" PT control port.
- One 1/4" PT supply port.



Table 8-52: Additional Spring Brake Valves

Part Number	Description	Reservoir Trip Pressure
Bendix 288063X Meritor R955288063X	Remanufactured Spring Brake Valve (Replaces Bendix SR-1™)	30 psi
Bendix 286364 Meritor R955286364N	Spring Brake Valve (Replaces Bendix SR-1™)	55 psi
Bendix 286364X Meritor R955286364X	Remanufactured Spring Brake Valve (Replaces Bendix SR-1™)	55 psi

SWITCHES - LOW PRESSURE INDICATORS



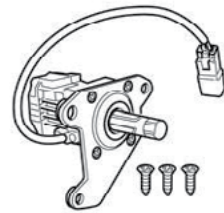
LOW PRESSURE INDICATORS FROM BENDIX

Table 8-53: Switches - Low Pressure Indicators (Bendix)

Part Number	Description	Cut-Out Pressure (PSI)	Pipe Thread A	Comments
104246N	Bendix LP-3™ Low Pressure Indicator - Single Terminal	66 ± 6 psi	1/4"	Push on terminal
279416N	Bendix LP-3™ Low Pressure Indicator - Single Terminal	60 ± 6 psi	1/4"	
279472	Bendix LP-3™ Low Pressure Indicator - Single Terminal	75 ± 6 psi	1/4"	
280530N	Bendix LP-3™ Low Pressure Indicator - Single Terminal	70 ± 6 psi	1/4"	
289397N	Bendix LP-3™ Low Pressure Indicator - Single Terminal	75 ± 6 psi	1/8"	
228750N	Bendix LP-3™ Low Pressure Indicator - Double Terminal	60 ± 6 psi	1/4"	
275083N	Bendix LP-3™ Low Pressure Indicator - Double Terminal	n/a	1/4"	Cut-In pressure of 75 ± 6 psi
276599N	Bendix LP-3™ Low Pressure Indicator - Double Terminal	30 ± 3 psi	1/4"	
277155N	Bendix LP-3™ Low Pressure Indicator - Double Terminal	50 ± 5 psi	1/4"	
280743N	Bendix LP-3™ Low Pressure Indicator - Double Terminal	60 ± 6 psi	1/4"	Push on terminal - without cable terminal
284793N	Bendix LP-3™ Low Pressure Indicator - Double Terminal	80 ± 6 psi	1/4"	without cable terminal
284833N	Bendix LP-3™ Low Pressure Indicator - Double Terminal	70 ± 6 psi	1/4"	without cable terminal
283029N	Bendix LP-3™ Low Pressure Indicator - Double Terminal	60 ± 6 psi	1/4"	without cable terminal
288522	Bendix LP-3™ Low Pressure Indicator - Double Terminal	66 ± 6 psi	1/4"	without cable terminal

Information & Images Provided by Bendix

SWITCHES - PARK BRAKE



PARK BRAKE SWITCHES FROM MERITOR

Table 8-54: Park Brake Switches from Meritor

Part Number	Description
S446 280 012 0	Parking Brake Switch Kit - mounted on the cab, not on the HCU - contains second generation switch and short bracket. Dash Knob not included. For 8 coil and 10 coil applications.
S446 280 013 0	Parking Brake Switch Kit - mounted on the cab, not on the HCU - contains third generation switch and short bracket. Dash Knob not included. For 8 coil and 10 coil applications.

Information & Images Provided by Meritor

SWITCHES - PARK BRAKE BUTTON COVERS



BRAKE BUTTON COVERS FROM BENDIX

Table 8-55: Brake Button Covers from Bendix

Part Number	Description	Shape
801526	Bendix E-Z-Grip® Soft Button Cover (Cap only) - Fits MV-3®/PP-DC® Valve Style	Diamond
801593	Bendix E-Z-Grip® Soft Button Cover (Cap only) - Fits PP-1® Valve Style	Diamond
802123	Bendix E-Z-Grip® Soft Button Cover (Cap only) - Fits PP-7™ Valve Style	Octagon
802124	Bendix E-Z-Grip® Soft Button Cover Kit (Caps only) - Contains both MV-3® Button Covers	Octagon & Diamond

Information & Images Provided by Bendix



BRAKE BUTTON COVERS FROM MERITOR

Table 8-56: Brake Button Covers from Meritor

Part Number	Description
S446 280 790 4	Parking Brake Switch Cover - (not included in the parking brake switch replacement kit) For 8 coil and 10 coil applications.

Information & Images Provided by Meritor

SWITCHES - STOP LIGHT



STOP LIGHT SWITCHES FROM BENDIX

Table 8-57: Stop Light Switches from Bendix

Part Number	Description	Pipe Thread
228687N	Bendix SL-4™ Stop Light Switch - 8-32 Thread Terminal	3/8"
228688	Bendix SL-4™ Stop Light Switch - 8-32 Thread Terminal	1/4"

Information & Images Provided by Bendix



ADDITIONAL STOP LIGHT SWITCHES

Table 8-58: Additional Stop Light Switches

Part Number	Description	Activation Pressure
Bendix 228600 Meritor R955228600N	Stop Light Switch (Replaces Bendix SL-4™)	5 psi (approximate)

NOTES

8



*For information, updates, or corrections,
please contact us at TRPBus@TRPParts.com*

*No part of this marketing material may be
reproduced in any manner without written
permission from TRP® North America.*

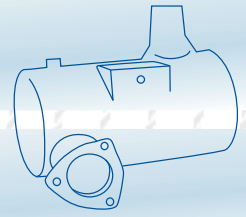
TRP® North America

750 Houser Way N.
Renton, WA 98057

www.trpparts.com



Parts for all brands of buses.



9

BUS PARTS

EMISSIONS

*Proven, reliable and
always innovative.*

TRP® offers reliable aftermarket products that are designed and tested to exceed customers' expectations regardless of the bus make, model or age.



DOC CATALYSTS • DPF FILTERS • CLAMPS •
HOSES • MUFFLERS



Tested. Reliable. Guaranteed.

Emissions

Choosing the right replacement part or service for your vehicle—whether you own one, or a fleet—is one of the most important decisions you can make for your business. And, with tested TRP® parts it's an easy decision.

Regardless of the make you drive, TRP® quality replacement parts are engineered to fit your truck, trailer or bus. Choose the parts that give you the best value for your business. Check them out at an approved TRP® retailer near you.

The cross reference information in this catalog is based upon data provided by several industry sources and our partners. While every attempt is made to ensure the information presented is accurate, we bear no liability due to incorrect or incomplete information.

Product Availability

Due to export restrictions and market demands, not all products are always available in every location. Check for availability in your area with your local TRP® Distributor.

No part of this marketing material may be reproduced in any manner without written permission from TRP® North America.

CONTENTS

DOC & DPF PRODUCTS

DOC Catalysts	9-3
DOC Catalysts - AZ Purifiers	9-3
DOC Catalysts - AZ Purimufflers	9-3
DPF Filters	9-4
DPF Filters - Purifilters	9-5
DPF Filters - PurifilterPLUS	9-5
DPF Filters - Diagnostic Kits	9-6
DPF Maintenance	9-6
DPF Control Panels for Purifilter Plus	9-6

EXHAUST PRODUCTS

Clamps	9-7
Flat Band	9-7
Guillotine	9-7
Welded Saddle	9-7
Flex Hoses	9-7
Non-Pre Cut, Light Duty	9-7
Pre-Cut	9-7
Pre-Cut, Light Duty	9-8
Pre-Cut, Heavy Duty	9-8
Pipes & Mufflers	9-8
Exhaust Pipe	9-8
Straight Connector	9-8
Mufflers	9-8

CROSS REFERENCE

Cross Reference for Emissions	9-9
Acrafit	9-9
Donaldson	9-9
Grand Rock	9-9
Tenneco/Walker	9-9

TRP® North America

750 Houser Way N.
Renton, WA 98057

www.trpparts.com

DOC & DPF PRODUCTS

WHAT IS A DIESEL OXIDATION CATALYST?

- A Diesel Oxidation Catalyst (DOC) uses a chemical process that break down pollutants from diesel engines in the exhaust stream
- Turns the exhaust stream into less harmful components
- Normally has a honeycomb shaped configuration coated in a catalyst designed to trigger a chemical reaction to reduce particulate matter

Verified Diesel Oxidation Catalysts: Purimuffler™ & AZ Purifier™

- Purimufflers and AZ Purifiers offer an industry - leading, verified 20 to 40% PM (Particulate Matter) reduction values from the EPA
- Current EPA verified technologies PM reduction values dependent upon the specific engine and application used USLD fuel. Values are subject to change.

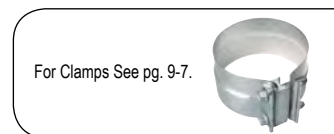


Table 9-1: DOC Catalysts - AZ Purifiers

Part Number	Description	Inlet Length	Outlet Length	Note
A16-0133	AZ Purifier - AZ25 Model	2.5"	2.5"	



Table 9-2: DOC Catalysts - AZ Purimufflers

Part Number	Description	Inlet Length	Outlet Length	Note
A17-1213	AZ Purimuffler - AZ28 Model	n/a	n/a	Type 2, Gm-c filter
A17-1200	AZ Purimuffler - AZ28 Model	4"	4"	
A17-1216	AZ Purimuffler - AZ29 Model	n/a	n/a	Type 2
A17-0580	AZ Purimuffler - AZ29 Model	3.5"	4"	
A17-1217	AZ Purimuffler - AZ30 Model	n/a	n/a	Type 2
A17-0584	AZ Purimuffler - AZ31 Model	n/a	n/a	
A17-0527	AZ Purimuffler - AZ31 Model	10"	10"	Type 1

DPF FILTERS

WHAT IS A DIESEL PARTICULATE FILTER?

A Diesel Particulate Filter (DPF) is a device designed to remove diesel particulate matter (DPM) or soot, from the exhaust of diesel engines. Diesel particulate filters can remove roughly 85% of the soot found in diesel emissions and can, at times, depending on the filter and other equipment it is paired with, attain 100% soot removal efficiencies.

Diesel-powered vehicles which are equipped with a DPF emit no visible emissions from the exhaust pipe, any emissions that are released are far less harmful not only to the environment, but to the general health of those in the vicinity of the running vehicle.

Verified Diesel Particulate Filters (DPF's)

Purifilter™ Passively Regenerating DPF

- The first passively regenerating DPF to attain an industry-leading 90% PM emissions reduction credit value*. Purifilters are more efficient as they are manufactured with Silicone Carbide substrates which offer superior filtration and durability compared to other DPF materials.
- Purifilter™ complies with stringent California Air Resources Board (CARB) limits on NO2 emissions.

PurifilterPLUS™ DPF

Allows extended periods of passive operation with periodic active regeneration providing:

- Optimized vehicle uptime with de-ashing extended to 1,500 hour intervals
- A proactive fleet management tool that improves fuel economy by reducing operation back pressure
- Reduced capital costs as regeneration equipment can be employed across a wide number of vehicles
- DPF solution for multi-use, multi-purpose fleets



Table 9-3: DPF Filters - Purifilters

Part Number	Description	Inlet Length	Outlet Length	Note
DPF FILTERS - PURIFILTERS				
A11U0339	Purifilter - SC13 Model	n/a	n/a	Unidirectional flow
C18-0014	Spare Purifilter - S9 Model	n/a	n/a	Center body
A11-0341	Purifilter - SC17 Model	Center	Center	
A11-0386	Purifilter - SC17 Model	Center	Center	
A11U0403	Purifilter - SC17H Model	n/a	n/a	Unidirectional flow
A11-0364	Purifilter - SC23 Model	Side	Side	
A19U0162	Purifilter - SCP23 Model	n/a	n/a	Exhaust gas recirculation
A11-0373	Purifilter - SC28 Model	Side	Side	
A11-0368	Purifilter - SC28 Model	Center	Center	
A19U0203	Purifilter - SCP28 Model	5"	n/a	



Table 9-4: DPF Filters - PurifilterPLUS

Part Number	Description	Inlet Length	Outlet Length	Note
DPF FILTERS - PURIFILTERPLUS				
A19U0155	PurifilterPLUS	n/a	n/a	
A19-0168	PurifilterPLUS	n/a	n/a	
A19-0175	PurifilterPLUS - SCP13 Model	4"	4"	
A19-0143	PurifilterPLUS - SCP13 Model	4"	4"	
A19U0169	PurifilterPLUS - SCP17 Model	4"	n/a	
A19-0149	PurifilterPLUS - SCP17 Model	5"	5"	
A19-0158	PurifilterPLUS - SCP20 Model	5"	5"	
A19-0114	PurifilterPLUS - SCP20 Model	5"	5"	
A19-0086	PurifilterPLUS - SCP28 Model	5"	5"	

DPF FILTERS - DIAGNOSTIC KITS

A56-0062	DPF Diagnostic Kit	n/a	n/a	
----------	--------------------	-----	-----	--

DPF MAINTENANCE

For yard and shop regenerations of filters

Table 9-5: DPF Control Panels

Part Number	Description	Volts	Power	Note
DPF CONTROL PANELS FOR PURIFILTER PLUS				
A69-0030	Control Panel for Purifilter Plus, SCP6-SCP23 Models	240	single phase	Electric; must be installed by qualified electrician
A69-0029	Control Panel for Purifilter Plus, SCP6-SCP23 Models	480	3 phase	Electric; must be installed by qualified electrician

Note: Emissions product is spec'd by vehicle and data logging may be required to determine correct product.

EXHAUST PRODUCTS

For DPF Filters See pg. 9-5.



CLAMPS

Table 9-6: Exhaust Clamps

Part Number	Description	Box Qty
FLAT BAND		
EC35FBZ	Exhaust Clamp, Flat Band (3.5"/9mm), Zinc, Heavy Duty	10
EC40FBC	Exhaust Clamp, Flat Band (4"/10mm), Chrome, Heavy Duty	10
EC40FBZ	Exhaust Clamp, Flat Band (4"/10mm), Zinc, Heavy Duty	10
EC50FBZ	Exhaust Clamp, Flat Band (5"/12.5mm), Zinc, Heavy Duty	10
EC50FBC	Exhaust Clamp, Flat Band (5"/12.5mm), Chrome, Heavy Duty	10
EC60FBC	Exhaust Clamp, Flat Band (6"/15mm), Chrome, Heavy Duty	10
EC60FBZ	Exhaust Clamp, Flat Band (6"/15mm), Zinc, Heavy Duty	10

GUILLOTINE

EC20GZ	Exhaust Clamp, Guillotine (2"/5mm), Zinc, Heavy Duty	10
EC35GZ	Exhaust Clamp, Guillotine (3.5"/9mm), Zinc, Heavy Duty	10
EC40GZ	Exhaust Clamp, Guillotine (4"/10mm), Zinc, Heavy Duty	10
EC50GZ	Exhaust Clamp, Guillotine (5"/12.5mm), Zinc, Heavy Duty	10
EC60GZ	Exhaust Clamp, Guillotine (6"/15mm), Zinc, Heavy Duty	10

WELDED SADDLE

EC40HD	Exhaust Clamp, Welded Saddle (4"/10mm)	10
EC50HD	Exhaust Clamp, Welded Saddle (5"/12.5mm)	10



FLEX HOSES

Table 9-7: Exhaust Flex Hoses

Part Number	Description	Quantity	Application
NON-PRE CUT, LIGHT DUTY			
EF40300SL	Flex Hose, Stainless Steel, Light Duty, 4" x 25'	25	n/a
EF50300SL	Flex Hose, Stainless Steel, Light Duty, 5" x 25'	25	n/a
PRE-CUT			
62240582	Pre-Cut Flex Hose, 304 Stainless Steel, Heavy Duty, 3" x 12"	1	Thomas Built
61240184	Pre-Cut Flex Hose, 304 Stainless Steel, Heavy Duty, 4" x 12"	1	Thomas Built

Note: Clamps connect pipes and components to avoid leaking of exhaust gases and to secure the exhaust components in place.

Part Number	Description	Quantity	Application
PRE-CUT, LIGHT DUTY			
EF4012SL	Pre-Cut Flex Hose, Stainless Steel, Light Duty, Pre-Cut, 4" x 12"	1	n/a
EF4018SL	Pre-Cut Flex Hose, Stainless Steel, Light Duty, Pre-Cut, 4" x 18"	1	n/a
EF4024SL	Pre-Cut Flex Hose, Stainless Steel, Light Duty, Pre-Cut, 4" x 24"	1	n/a
EF4036SL	Pre-Cut Flex Hose, Stainless Steel, Light Duty, Pre-Cut, 4" x 36"	1	n/a
EF5012SL	Pre-Cut Flex Hose, Stainless Steel, Light Duty, Pre-Cut, 5" x 12"	1	n/a
EF5018SL	Pre-Cut Flex Hose, Stainless Steel, Light Duty, Pre-Cut, 5" x 18"	1	n/a
EF5024SL	Pre-Cut Flex Hose, Stainless Steel, Light Duty, Pre-Cut, 5" x 24"	1	n/a
EF5036SL	Pre-Cut Flex Hose, Stainless Steel, Light Duty, Pre-Cut, 5" x 36"	1	n/a

PRE-CUT, HEAVY DUTY

30-12S	Pre-Cut Flex Hose, 304 Stainless Steel, Heavy Duty, 3" x 12"	1	n/a
40-12S	Pre-Cut Flex Hose, 304 Stainless Steel, Heavy Duty, 4" x 12"	1	n/a

PIPES & MUFFLERS

Table 9-8: Exhaust Pipes

Part Number	Description	Measurement	Length
EXHAUST PIPE			
EF40STR120	Exhaust Pipe, Cold Rolled Steel, Straight, 4" x 10'	Outside Diameter to Outside Diameter: 4"	10'
STRAIGHT CONNECTOR			
EN40CN304A	Straight Connector, Aluminized Steel, 4" x 6"	Inside Diameter to Inside Diameter: 4"	6"

Table 9-9: Exhaust Mufflers

Part Number	Description	Inlet Inside Diameter	Outlet Inside Diameter	Body Size	Body Length	Overall Length	Inlet Length
MUFFLERS							
EMM10102	Type 1 Muffler, Body Length 44.5", Overall Length 51"	5"	5"	9"	44.5"	51"	3"
EMM10108	Type 1 Muffler, Body Length 44.5", Overall Length 51"	4"	4"	9"	44.5"	51"	3"
EMM10127	Type 1 Muffler, Body Length 34.4", Overall Length 40"	4"	4"	8.5"	34.4"	40"	2.5"

Note: Emissions product is spec'd by vehicle and data logging may be required to determine correct product.

CROSS REFERENCE**CROSS REFERENCE FOR EMISSIONS**

Table 9-10: Cross Reference for Emissions

Manufacturer	MFR Part Number	TRP Part Number
Acrafit	50-300SL	EF50300SL
Acrafit	50-12SL	EF5012SL
Acrafit	50-18SL	EF5018SL
Acrafit	50-24SL	EF5024SL
Acrafit	50-36SL	EF5036SL
Acrafit	40-300SL	EF40300SL
Acrafit	40-12SL	EF4012SL
Acrafit	40-18SL	EF4018SL
Acrafit	40-24SL	EF4024SL
Acrafit	40-36SL	EF4036SL
Acrafit	40STR120	EF40STR120
Acrafit	M10102	EMM10102
Acrafit	M10108	EMM10108
Acrafit	M10108	EMM10108
Acrafit	M10127	EMM10127
Acrafit	40CN304A	EN40CN304A
Donaldson	P226158	EF50300SL
Donaldson	J240007	EF5012SL
Donaldson	P206555	EF5018SL
Donaldson	J024838	EF5024SL
Donaldson	J034674	EF5036SL
Donaldson	P226156	EF40300SL
Donaldson	J240006	EF4012SL
Donaldson	P206554	EF4018SL
Donaldson	J024836	EF4024SL
Donaldson	J034673	EF4036SL
Grand Rock	SF-5300	EF50300SL
Grand Rock	SF-512	EF5012SL
Grand Rock	SF-518	EF5018SL

Manufacturer	MFR Part Number	TRP Part Number
Grand Rock	SF-524	EF5024SL
Grand Rock	SF-536	EF5036SL
Grand Rock	SF-4300	EF40300SL
Grand Rock	SF-412	EF4012SL
Grand Rock	SF-418	EF4018SL
Grand Rock	SF-424	EF4024SL
Grand Rock	SF-436	EF4036SL
Tenneco/Walker	40023	EF50300SL
Tenneco/Walker	41693	EF5012SL
Tenneco/Walker	42424	EF5018SL
Tenneco/Walker	42339	EF5024SL
Tenneco/Walker	43203	EF5036SL
Tenneco/Walker	40022	EF40300SL
Tenneco/Walker	41691	EF4012SL
Tenneco/Walker	42423	EF4018SL
Tenneco/Walker	42338	EF4024SL
Tenneco/Walker	43202	EF4036SL



*For information, updates, or corrections,
please contact us at TRPBus@TRPParts.com*

*No part of this marketing material may be
reproduced in any manner without written
permission from TRP® North America.*

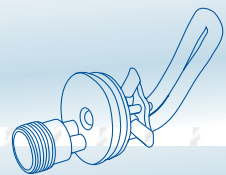
TRP® North America

750 Houser Way N.
Renton, WA 98057

www.trpparts.com



BUS PARTS[®]



10

COLD WEATHER

*Proven, reliable and
always innovative.*

TRP[®] offers reliable aftermarket products that are designed and tested to exceed customers' expectations regardless of the bus make, model or age.



COOLANT HEATERS • IMMERSION/BLOCK HEATERS •
HEATER KITS



Tested. Reliable. Guaranteed.

Cold Weather

Choosing the right replacement part or service for your vehicle—whether you own one, or a fleet—is one of the most important decisions you can make for your business. And, with tested TRP® parts it's an easy decision.

Regardless of the make you drive, TRP® quality replacement parts are engineered to fit your truck, trailer or bus. Choose the parts that give you the best value for your business. Check them out at an approved TRP® retailer near you.

The cross reference information in this catalog is based upon data provided by several industry sources and our partners. While every attempt is made to ensure the information presented is accurate, we bear no liability due to incorrect or incomplete information.

Product Availability

Due to export restrictions and market demands, not all products are always available in every location. Check for availability in your area with your local TRP® Distributor.

No part of this marketing material may be reproduced in any manner without written permission from TRP® North America.

CONTENTS

COOLANT HEATERS

Espar Heaters	10-3
E-Guardian Heater Series (School bus) – D5 Series	10-3
E-Guardian Heater Series (School bus) – D8-D12 Series	10-3
E-Guardian Heater Series (School bus) – Basic	10-3
Webasto Heaters	10-4
DBW2010 Model, Engine Coolant Heaters	10-4
Thermo Top/TSL17, Engine Coolant Heaters	10-4
Hotstart Heaters	10-5
Immersion/ Block Heaters	10-5
Phillips & Temro/Zerostart	10-5
Immersion/Block Heaters	10-5

TRP® North America

750 Houser Way N.
Renton, WA 98057

www.trpparts.com



COOLANT HEATERS

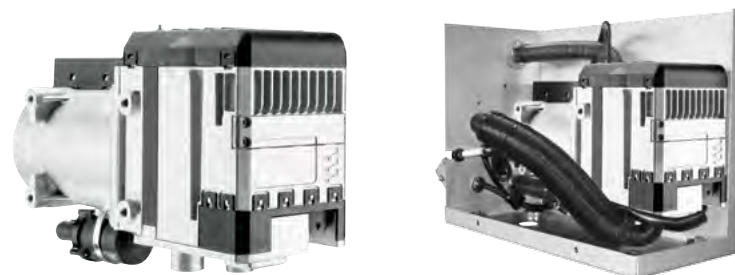
ESPAR HEATERS

- Coolant Heaters circulate hot water through the Bus chassis and the engine, allowing the driver to have a zero-emission start for the engine and sit in a warm cab.

Table 10-1: Espar E-Guardian Heater Series (School bus)

Part Number	Description	Volts	BTU's
			
E-GUARDIAN HEATER SERIES (SCHOOL BUS) – D5 SERIES			
25.2823.25.0500.OZ	Boxed D5 E-Guardian Heater Kit	12	17,000
25.2823.25.0505.OZ	Boxed D5 E-Guardian Heater Kit (specs for New York)	12	17,000
25.2823.25.0501.OZ	Boxed D5 E-Guardian High Altitude Heater Kit	12	17,000
25.2823.25.0506.OZ	Basic D5 E-Guardian Heater Assembly	12	17,000

E-GUARDIAN HEATER SERIES (SCHOOL BUS) – D8-D12 SERIES

			
25.2824.70.0800.OZ	Boxed D8 E-Guardian Heater Kit	12	27,000
25.2824.34.1000.OZ	Boxed D10 E-Guardian Heater Kit	12	32,500
25.2824.72.1200.OZ	Boxed D12 E-Guardian Heater Kit	12	42,000
25.2824.72.1205.OZ	Boxed D12 E-Guardian Heater Kit (specs for New York)	12	42,000
25.2824.73.1200.OZ	Boxed D12 E-Guardian Heater Kit	24	42,000

E-GUARDIAN HEATER SERIES (SCHOOL BUS) – BASIC

25.2824.72.1201.OZ	Basic E-GUARDIAN Heater Assembly 12kw	12	42,000
--------------------	---------------------------------------	----	--------

**Note: Driver will need to turn the key and swith on the blower motor for the heater. Information & Images Provided by Espar*

WEBASTO HEATERS

- Coolant Heaters circulate hot water through the Bus chassis and the engine, allowing the driver to have a zero-emission start for the engine and sit in a warm cab.

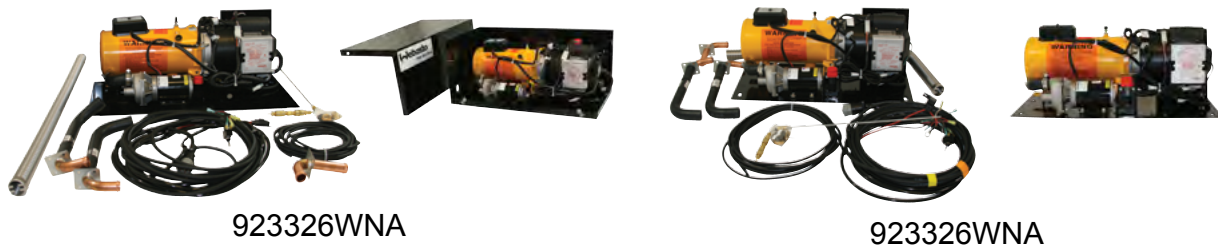
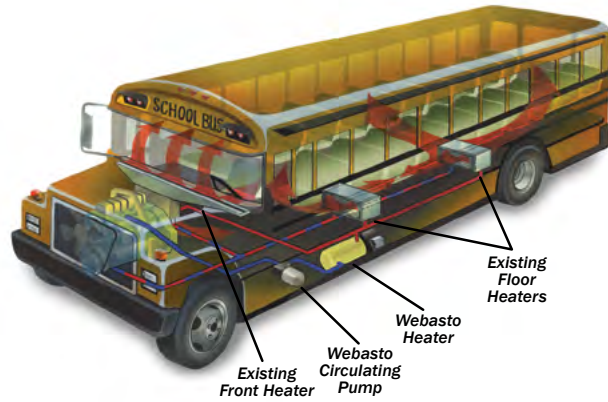


Table 10-2: Webasto Heaters, DBW2010 & Thermo Top

Part Number	Description	Battery Volts	BTU's
DBW2010 MODEL, ENGINE COOLANT HEATERS			
923326WNA	Scholastic School Bus Heater Kit	12	45,000
923317WNA	Scholastic School Bus Heater Kit for Retrofit	12	45,000

THERMO TOP/TSL17, ENGINE COOLANT HEATERS



5001544AWNA	Thermo Top C School Bus Heater - 17,200 btu	12	8,600-17,200
-------------	---	----	--------------

*Note: Driver will need to turn the key and switch on the blower motor for the heater.
Information & Images Provided by Webasto

IMMERSION/BLOCK HEATERS



HOTSTART HEATERS

- Immersion/Block Heaters insert into the water jacket of the Engine Block and plug into a 120V outlet to heat the Engine coolant.



Table 10-3: Hotstart Immersion Heaters, for Caterpillar Engines

Part Number	Description	Volts	Engine Model
IMMERSION/ BLOCK HEATERS FOR CATERPILLAR ENGINES			
FP151-001WOC	Immersion/Block Engine Heater, FP 1500W, 120V, no cord	120	Caterpillar - C7
DD8L101WOC	Immersion/Block Engine Heater, 1000W, 120V, no cord	120	Cummins ISC
TF751-002WOC	Immersion/Block Engine Heater, 750W, 120V 3/4" NPT, Fixed	120	Cummins ISB

NPT= National Pipe Thread

PHILLIPS & TEMRO/ZEROSTART

- Immersion/Block Heaters insert into the water jacket of the Engine Block and plug into a 120V outlet to heat the Engine coolant.

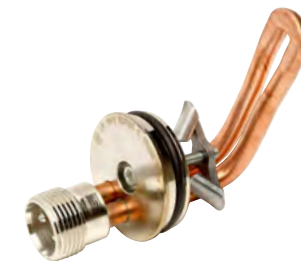


Table 10-4: Phillips & Temro/ Zerostart

Part Number	Description	Volts	Engine Model
CATERPILLAR			
350-0015	Immersion/Block Engine Heater, 1000W, 120V, 44mm Freeze plug	120	Caterpillar - 2004-2007 C7 Acert, 3116, 3126, 3126B, C7 prior to 2004
350-0016	Immersion/Block Engine Heater, 1000W, 240V, 44mm Freeze plug	240	Caterpillar - 2004-2007 C7 Acert, 3116, 3126, 3126B, C7 prior to 2004
350-0081	Immersion/Block Engine Heater, 1500W, 120V, 44mm Freeze plug	120	Caterpillar - 2004-2007 C7 Acert, 3116, 3126, 3126B, C7 prior to 2004
CUMMINS			
350-0022	Immersion/Block Engine Heater, 750W, 120V, 3/4" NPT Thread	120	Cummins - 2007 ISB 6.7L & QSB(6.7L & 4.5L), ISB, QSB (3.9L & 5.9L)
350-0032	Immersion/Block Engine Heater, 1000W, 120V, 3/4" NPT Thread	120	Cummins - ISC, QSC (8.3L 505 CID), ISL (8.9L 543 CID)
350-0030	Immersion/Block Engine Heater, 750W, 120V, 58mm Freeze plug	120	Cummins - 1987-2002 B Series: 4B3.9 & 4BT3.9, 6B5.9 & 6BT5.9
860-1666	Immersion/Block Engine Heater, 750W, 240V, 58mm Freeze plug	240	Cummins - 1987-2002 B Series: 4B3.9 & 4BT3.9, 6B5.9 & 6BT5.9
860-1852	Immersion/Block Engine Heater, 1000W, 240V, 58mm Freeze plug	240	Cummins - C Series: 6C8.3 & 6CT8.3, 6CTA8.3

Information & Images Provided by Phillips & Temro/ZEROSTART



*For information, updates, or corrections,
please contact us at TRPBus@TRPParts.com*

*No part of this marketing material may be
reproduced in any manner without written
permission from TRP® North America.*

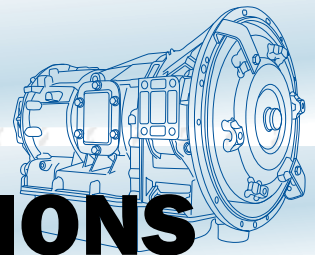
TRP® North America

750 Houser Way N.
Renton, WA 98057

www.trpparts.com



Parts for all brands of buses.



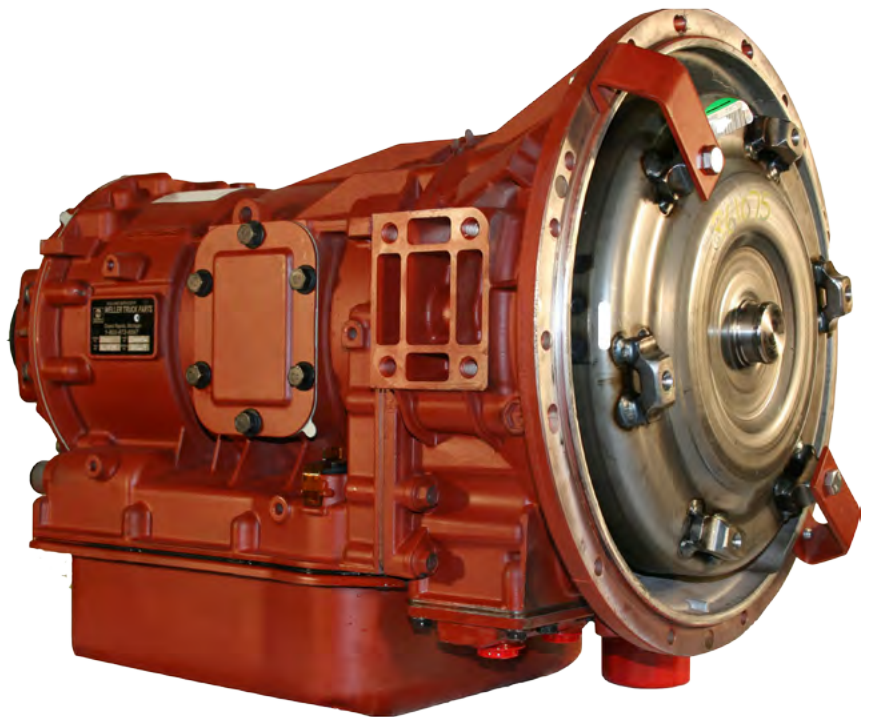
11

BUS PARTS[®]

TRANSMISSIONS

*Proven, reliable and
always innovative.*

TRP[®] offers reliable aftermarket products that are designed and tested to exceed customers' expectations regardless of the bus make, model or age.



AUTOMATIC • MANUAL TRANSMISSIONS



Tested. Reliable. Guaranteed.

Transmissions

Choosing the right replacement part or service for your vehicle—whether you own one, or a fleet—is one of the most important decisions you can make for your business. And, with tested TRP® parts it's an easy decision.

Regardless of the make you drive, TRP® quality replacement parts are engineered to fit your truck, trailer or bus. Choose the parts that give you the best value for your business. Check them out at an approved TRP® retailer near you.

The cross reference information in this catalog is based upon data provided by several industry sources and our partners. While every attempt is made to ensure the information presented is accurate, we bear no liability due to incorrect or incomplete information.

Product Availability

Due to export restrictions and market demands, not all products are always available in every location. Check for availability in your area with your local TRP® Distributor.

No part of this marketing material may be reproduced in any manner without written permission from TRP® North America.

CONTENTS

AUTOMATIC TRANSMISSIONS FOR CANADA

[Remanufactured by Weller](#) 11-3

[Remanufactured by Mascot](#) 11-4

MANUAL TRANSMISSIONS FOR CANADA

[Remanufactured by Weller](#) 11-4

[Remanufactured by Mascot](#) 11-5

AUTOMATIC TRANSMISSIONS FOR U.S.

[Remanufactured by Weller](#) 11-6

MANUAL TRANSMISSIONS FOR U.S.

[Remanufactured by Weller](#) 11-7

BUS APPLICATIONS FOR

ALLISON TRANSMISSIONS

[Bus Applications for Allison Transmissions](#) 11-8

1000 PTS 11-8

2100 PTS 11-8

2200 PTS 11-8

2300 PTS8 11-8

2350 PTS6 11-8

2500 PTS5 11-8

2550 PTS6 11-8

3000 PTS 11-8

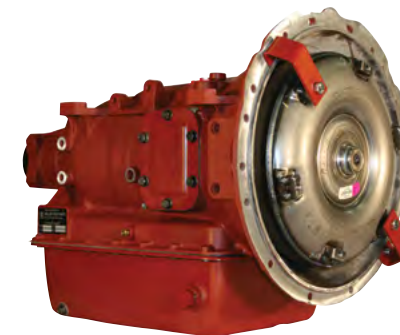
TRP® North America

750 Houser Way N.
Renton, WA 98057

www.trpparts.com

AUTOMATIC & MANUAL TRANSMISSIONS FOR CANADA

For Manual Transmissions See pg. 11-6.



AT545WELC



MD3060PWELC



15986036MAS

AUTOMATIC TRANSMISSIONS FOR CANADA

Table 11-1: Automatic Transmissions for Canada - Remanufactured by Weller

Part Number	Description	RPM	Max Input Power (kW)	Max Input Torque (Nm)
REMANUFACTURED BY WELLER				
AT545WELC	Allison Remanufactured Transmissions by Weller - AT545	2400	175	603
AT545NWELC	Allison Remanufactured Transmissions by Weller - AT545N	2600	175	603
MT643WELC	Allison Remanufactured Transmissions by Weller - MT643	2400	186	868
MD3060P-WELC	Allison Remanufactured Transmissions by Weller - MD3060P	2000-2800	205	1085
MD3560P-WELC	Allison Remanufactured Transmissions by Weller - MD3560P	2000-2800	205	1085
2100PTSWELC	Allison Remanufactured Transmissions by Weller - 2100PTS	2200-3800	224	746
2200PTSWELC	Allison Remanufactured Transmissions by Weller - 2200PTS	2200-3800	224	746
2500PTSWELC	Allison Remanufactured Transmissions by Weller - 2500PTS	2200-3800	224	746
3000PTSWELC	Allison Remanufactured Transmissions by Weller - 3000PTS	2000-2800	224	1288
B210WELC	Allison Remanufactured Transmissions by Weller - B210	2000-2800	240	900
B220WELC	Allison Remanufactured Transmissions by Weller - B220	2000-2800	240	900
B300RWELC	Allison Remanufactured Transmissions by Weller - B300R	2000-2800	186	929
B300WELC	Allison Remanufactured Transmissions by Weller - B300	2000-2800	186	929
B400PRWELC	Allison Remanufactured Transmissions by Weller - B400PR	2000-2800	201	1180
B400RWELC	Allison Remanufactured Transmissions by Weller - B400R	2000-2800	201	1180
B400WELC	Allison Remanufactured Transmissions by Weller - B400	2000-2800	201	1180
B500RWELC	Allison Remanufactured Transmissions by Weller - B500R	1700-2300	280	1627
B500WELC	Allison Remanufactured Transmissions by Weller - B500	1700-2300	280	1627

Table 11-2: Automatic Transmissions for Canada - Remanufactured by Mascot

Part Number	Description	RPM	Power Take-Off (PTO)	Torque Converter (T/C)
REMANUFACTURED BY MASCOT				
15986036MAS	Allison Remanufactured Transmissions by Mascot - AT545N	2600	Yes	290
23015179MAS	Allison Remanufactured Transmissions by Mascot - AT545	2400	Yes	290
29500307MAS	Allison Remanufactured Transmissions by Mascot - AT545	2400	Yes	290
29505061MAS	Allison Remanufactured Transmissions by Mascot - AT545	2400	Yes	290
29505388MAS	Allison Remanufactured Transmissions by Mascot - AT545	2400	Yes	290
29508650MAS	Allison Remanufactured Transmissions by Mascot - AT545	2400	Yes	290
29509167MAS	Allison Remanufactured Transmissions by Mascot - MT643	2400	Yes	370
29512406MAS	Allison Remanufactured Transmissions by Mascot - MT643	2400	Yes	370
29514623MAS	Allison Remanufactured Transmissions by Mascot - AT545	2400	Yes	290
29514624MAS	Allison Remanufactured Transmissions by Mascot - AT545	2400	Yes	290
29542158MAS	Allison Remanufactured Transmissions by Mascot - MD3060	2000-2800	n/a	n/a

MANUAL TRANSMISSIONS FOR CANADA

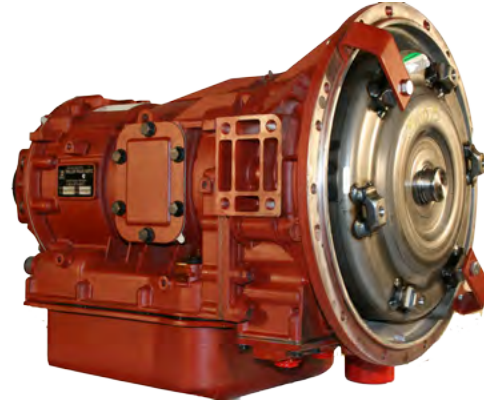
Table 11-3: Manual Transmissions for Canada - Remanufactured by Weller

Part Number	Description	Nominal Torque Capacity	Design Level
REMANUFACTURED BY WELLER			
FS4205AWELC	Fuller Remanufactured Transmissions by Weller - FS4205A - 5 Speed	460	Coarse pitch clutching teeth spline
FS5106AWELC	Fuller Remanufactured Transmissions by Weller - FS5106A - 6 Speed	560	n/a
FS5205AWELC	Fuller Remanufactured Transmissions by Weller - FS5205A - 5 Speed	560	Coarse pitch clutching teeth spline
FS5406AWELC	Fuller Remanufactured Transmissions by Weller - FS5406A - 6 Speed	560	Boosted Synchronizer
FS6206AWELC	Fuller Remanufactured Transmissions by Weller - FS6206A - 6 Speed	660	Coarse pitch clutching teeth spline
FS6306AWELC	Fuller Remanufactured Transmissions by Weller - FS6306A - 6 Speed	660	Fine pitch clutching teeth spline
FS6406AWELC	Fuller Remanufactured Transmissions by Weller - FS6406A - 6 Speed	660	Boosted Synchronizer
FS4205AWELC	Fuller Remanufactured Transmissions by Weller - FS4205A - 5 Speed	460	Coarse pitch clutching teeth spline

Table 11-4: Manual Transmissions for Canada - Remanufactured by Mascot

Part Number	Description	Nominal Torque Capacity	Design Level
REMANUFACTURED BY MASCOT			
FS06406AMAS	Fuller Remanufactured Transmissions by Mascot- FS06406A - 6 Speed	660	Boosted Synchronizer
FS5406AMAS	Fuller Remanufactured Transmissions by Mascot- FS5406A - 6 Speed	560	Boosted Synchronizer
FS6206AMAS	Fuller Remanufactured Transmissions by Mascot- FS6206A - 6 Speed	660	Coarse pitch clutching teeth spline
FS6306AMAS	Fuller Remanufactured Transmissions by Mascot- FS6306A - 6 Speed	660	Fine pitch clutching teeth spline
FS6406AMAS	Fuller Remanufactured Transmissions by Mascot- FS6406A - 6 Speed	660	Boosted Synchronizer

AUTOMATIC & MANUAL TRANSMISSIONS FOR U.S.



AUTOMATIC TRANSMISSIONS FOR U.S.

Table 11-5: Automatic Transmissions for U.S. - Remanufactured by Weller

Part Number	Description	RPM	Max Input Power (kW)	Max Input Torque (Nm)
REMANUFACTURED BY WELER				
AT545WEL	Allison Remanufactured Transmissions by Weller - AT545	2400	235	603
B500WEL	Allison Remanufactured Transmissions by Weller - B500	1700-2300	280	1627
AT545NWEL	Allison Remanufactured Transmissions by Weller - AT545N	2600	235	603
MT643WEL	Allison Remanufactured Transmissions by Weller - MT643	2400	250	867
MD3060PWEL	Allison Remanufactured Transmissions by Weller - MD3060P	2000-2800	205	1085
MD3560PWEL	Allison Remanufactured Transmissions by Weller - MD3560P	2000-2800	205	1085
2100PTSWEL	Allison Remanufactured Transmissions by Weller - 2100PTS	2200-3800	224	746
2200PTSWEL	Allison Remanufactured Transmissions by Weller - 2200PTS	2200-3800	224	746
2500PTSWEL	Allison Remanufactured Transmissions by Weller - 2500PTS	2200-3800	224	746
3000PTSWEL	Allison Remanufactured Transmissions by Weller - 3000PTS	2000-2800	224	1288
B210WEL	Allison Remanufactured Transmissions by Weller - B210	2000-2800	240	900
B220WEL	Allison Remanufactured Transmissions by Weller - B220	2000-2800	240	900
B300RWEL	Allison Remanufactured Transmissions by Weller - B300R	2000-2800	186	929
B300WEL	Allison Remanufactured Transmissions by Weller - B300	2000-2800	186	929
B400PRWEL	Allison Remanufactured Transmissions by Weller - B400PR	2000-2800	201	1180
B400RWEL	Allison Remanufactured Transmissions by Weller - B400R	2000-2800	201	1180
B400WEL	Allison Remanufactured Transmissions by Weller - B400	2000-2800	201	1180
B500RWEL	Allison Remanufactured Transmissions by Weller - B500R	1700-2300	280	1627

MANUAL TRANSMISSIONS FOR U.S.

For Transmission Fluid See pg. 13-9.



Table 11-6: Manual Transmissions for U.S. - Remanufactured by Weller

Part Number	Description	Nominal Torque Capacity	Design Level
REMANUFACTURED BY WELER			
FS4205AWEL	Fuller Remanufactured Transmissions by Weller - FS4205A - 5 Speed	460	Coarse pitch clutching teeth spline
FS5106AWEL	Fuller Remanufactured Transmissions by Weller - FS5106A - 6 Speed	560	n/a
FS5205AWEL	Fuller Remanufactured Transmissions by Weller - FS5205A - 5 Speed	560	Coarse pitch clutching teeth spline
FS5406AWEL	Fuller Remanufactured Transmissions by Weller - FS5406A - 6 Speed	560	Boosted Synchronizer
FS6206AWEL	Fuller Remanufactured Transmissions by Weller - FS6206A - 6 Speed	660	Coarse pitch clutching teeth spline
FS6306AWEL	Fuller Remanufactured Transmissions by Weller - FS6306A - 6 Speed	660	Fine pitch clutching teeth spline
FS6406AWEL	Fuller Remanufactured Transmissions by Weller - FS6406A - 6 Speed	660	Boosted Synchronizer
FS4205AWEL	Fuller Remanufactured Transmissions by Weller - FS4205A - 5 Speed	460	Coarse pitch clutching teeth spline

BUS APPLICATIONS FOR ALLISON TRANSMISSIONS

BUS APPLICATIONS FOR ALLISON TRANSMISSIONS

Table 11-7: Bus Applications Table for Allison Transmissions

Transmission Model for School Bus	Ratio	Park Pawl	Max Input Power 1 hp (kW)	Max Input Torque 1 lb-ft (N • m)	Max Input Torque w/SEM or Torque Limiting *1, 2 lb-ft (N • m)	Max Turbine Torque *3 lb-ft (N • m)	Max GVW lbs (kg)	Max GCW lbs (kg)
1000 PTS	Close	Yes	300 *4 (224) *4	550 (746)	660 *6,7 (895) *6,7	9507 (1288) *7	19,500 (8,845)	26,001 (11,800)
	Close	Yes	300 *4 (224) *4	550 (746)	565 (766)	9507 (1288) *7	19,500 (8,845)	26,001 (11,800)
2100 PTS	Close	No	300 *4 (224) *4	550 (746)	660 *6,7 (895) *6,7	9507 (1288) *7	26,000 (11,800)	26,000 (11,800)
	Close	No	300 *4 (224) *4	550 (746)	565 (766)	9507 (1288) *7	26,000 (11,800)	26,000 (11,800)
2200 PTS	Close	Yes	300 *4 (224) *4	550 (746)	660 *6,7 (895) *6,7	9507 (1288) *7	26,000 (11,800)	26,001 (11,800)
	Close	Yes	300 *4 (224) *4	550 (746)	565 (766)	9507 (1288) *7	26,000 (11,800)	26,001 (11,800)
2300 PTS*8	Close	No	325 (242)	n/a	450 (610)	9507 (1288) *7	33,000 (15,000)	33,000 (15,000)
2350 PTS*6	Close	Yes	300 *4 (224) *4	550 (746)	660 *7 (895) *7	9507 (1288) *7	30,000 (13,600)	33,000 (15,000)
2500 PTS*5	Wide	No	300 (224)	550 (746)	660 *7 (895) *6,7	9507 (1288) *7	33,000 (15,000)	33,000 (15,000)
2550 PTS*6	Wide	Yes	300 (224)	550 (746)	660 *7 (895) *7	9507 (1288) *7	30,000 (13,600)	30,000 (13,600)
3000 PTS	Wide	n/a	300 (224)	950 (1288)	n/a	1470 (1995)	—	—
	Wide	n/a	300 (224)	950 (1288)	n/a	1470 (1995)	33,000 (15,000)	33,000 (15,000)

*1 Gross ratings as defined by ISO 1585 or SAE J1995.

*2 SEM = engine controls with Shift Energy Management.

*3 Turbine torque limit based on iSCAAN standard deductions.

*4 Gross input power rating is 340 hp/254 kW for VORTEC 8.1L gasoline powered engines.

*5 2500 PTS available for School Bus applications only.

*6 Check with your OEM to ensure offerings.

*7 SEM and torque limiting are required to obtain this rating.

*8 Only available with VORTEC 8.1L gasoline powered engine applications.

NOTES



*For information, updates, or corrections,
please contact us at TRPBus@TRPParts.com*

*No part of this marketing material may be
reproduced in any manner without written
permission from TRP® North America.*

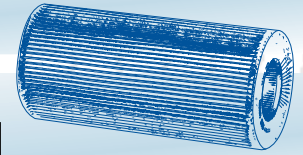
TRP® North America

750 Houser Way N.
Renton, WA 98057

www.trpparts.com



Parts for all brands of buses.



12

BUS PARTS®

FILTRATION

*Proven, reliable and
always innovative.*

TRP® offers reliable aftermarket products that are designed and tested to exceed customers' expectations regardless of the bus make, model or age.



AIR • COOLANT • LUBE/OIL • FUEL & FUEL/WATER
SEPERATORS • TRANSMISSION



Tested. Reliable. Guaranteed.

Filtration

Choosing the right replacement part or service for your vehicle—whether you own one, or a fleet—is one of the most important decisions you can make for your business. And, with tested TRP® parts it's an easy decision.

Regardless of the make you drive, TRP® quality replacement parts are engineered to fit your truck, trailer or bus. Choose the parts that give you the best value for your business. Check them out at an approved TRP® retailer near you.

The cross reference information in this catalog is based upon data provided by several industry sources and our partners. While every attempt is made to ensure the information presented is accurate, we bear no liability due to incorrect or incomplete information.

Product Availability

Due to export restrictions and market demands, not all products are always available in every location. Check for availability in your area with your local TRP® Distributor.

No part of this marketing material may be reproduced in any manner without written permission from TRP® North America.

CONTENTS

Racor 12-10

BLUE BIRD

Blue Bird Air Filters 12-11

Air Filter 12-11

Radial Seal Air Filter 12-11

Coolant Filter 12-12

Coolant Filter, Spin-On 12-12

Blue Bird Fuel Filters 12-12

Fuel Filter 12-12

Fuel Filter - Made From 2003 to 2005, Thread Both Ends . . 12-13

Fuel Filter - Made From 2003 to 2005, Thread One End . . . 12-13

Fuel Filter, In-Line 12-13

Fuel Filter, Spin-On 12-13

Fuel Filter/Water Separator Cartridge 12-13

Primary Fuel Filter, Spin-On 12-13

Secondary Fuel Filter, Spin-On 12-14

Blue Bird Fuel/Water Separator Filters 12-14

Fuel/Water Separator Filter 12-14

Fuel/Water Separator Filter - Open End 12-14

Fuel/Water Separator Filter - Open End, Spin-On 12-15

Fuel/Water Separator Filter - Rectangle Sensor, Spin-On . . . 12-15

Fuel/Water Separator Filter - with 1/2-20 Sensor Port Thread, Spin-On 12-15

Fuel/Water Separator Filter - with 9/16-18 Sensor Port Thread 12-15

TRP® North America

750 Houser Way N.
Renton, WA 98057

www.trpparts.com

Fuel/Water Separator Filter - with 9/16-18 Sensor Port Thread, Spin-On 12-15

Fuel/Water Separator Filter - with Sensor Port 12-15

Fuel/Water Separator Filter - without Sensor Port 12-15

Fuel/Water Separator Filter - without Sensor Port, Spin-On 12-15

Fuel/Water Separator Filter - with Drain . . 12-15

Fuel/Water Separator Filter - with Drain, Spin-On 12-16

Fuel/Water Separator Filter Element 12-16

Fuel/Water Separator Filter, Spin-On 12-16

Blue Bird Lube/Oil Filters 12-16

Combination Lube Filter, Spin-On 12-16

Dual-Flow Lube Filter 12-16

Full-Flow Lube Filter, Spin-On 12-16

Lube Element Filter 12-17

Lube Filter 12-17

Lube Filter - Made Before January 2004 . . 12-17

Lube Filter - Made From January 2004 to Present 12-17

Lube Filter - Made From 2003 to 2006 . . . 12-17

Lube Filter - Made From 2007 to Present . 12-17

Lube Filter - without Screw-On Cap 12-18

Lube Filter, Cartridge 12-18

Lube Filter, Combination 12-18

Lube Filter, Spin-On 12-18

Blue Bird Transmission Filters 12-18

Transmission Filter 12-18

Transmission Filter - for 5R110W, Made Before November 2007 12-20

Transmission Filter - for 5R110W, Made From November 2007 to Present . . 12-20

Transmission Filter - for AODE 12-20

Transmission Filter Element - 2" Kit 12-20

Transmission Filter Element - 2" Kit, 3000 & 4000 Series 12-20

Transmission Filter Element - 4" Kit 12-20

Transmission Filter Element - 4" Kit, 3000 & 4000 Series 12-20

Transmission Filter Kit 12-20

Transmission Filter Pan-Type - 3.8" Pan . . 12-20

Transmission Filter Pan-Type - 3.8" Pan, AT Series 12-20

Transmission Filter Pan-Type - 5.3" Pan . . 12-21

Transmission Filter Pan-Type - 5.3" Pan, AT & MT Series 12-21

Transmission Filter Pan-Type - Deep Pan with Gasket 12-21

Transmission Filter Pan-Type - Deep Pan with Gasket, 2000 Series 12-21

Transmission Filter Pan-Type - Deep Pan without Gasket 12-21

Transmission Filter Pan-Type - Deep Pan without Gasket, 2000 Series 12-21

Transmission Filter Pan-Type - Shallow Pan with Gasket 12-21

Transmission Filter Pan-Type - Shallow Pan with Gasket, 2000 Series 12-22

Transmission Filter Pan-Type - Shallow Pan without Gasket 12-22

Transmission Filter Pan-Type - Shallow Pan without Gasket, 2000 Series 12-22

Transmission Filter, Spin-On 12-22

Transmission Filter, Spin-On - 2000 Series 12-22

Transmission Filter, Spin-On - AT & MT Series 12-22

Transmission Filter, Spin-On - AT & MT Series, Auxiliary 12-22

COLLINS

Collins Air Filters 12-23

Air Filter 12-23

Radial Seal Air Filter 12-23

Collins Fuel Filters 12-23

Fuel Filter 12-23

Fuel Filter - Made From 2003 to 2005, Thread Both Ends 12-23

Fuel Filter - Made From 2003 to 2005, Thread One End 12-23

Collins Fuel/Water Separator Filters 12-24

Fuel/Water Separator Filter 12-24

Collins Lube/Oil Filters 12-24

- Lube Filter 12-24
- Lube Filter - Made From 2003 to 2005 . . . 12-24
- Lube Filter - Made From 2003 to 2006 . . . 12-24
- Lube Filter - Made From 2006 to Present . 12-24
- Lube Filter - Made From 2007 to Present . 12-24
- Lube Filter - without Screw-On Cap. 12-24
- Collins Steering Filters** 12-25
 - Steering Filter 12-25
- Collins Transmission Filters** 12-25
 - Transmission Filter - Deep Pan with Gasket 12-25
 - Transmission Filter - Deep Pan without Gasket 12-25
 - Transmission Filter - Deep Pan, for 4L60E 12-25
 - Transmission Filter - Shallow Pan with Gasket 12-25
 - Transmission Filter - Shallow Pan without Gasket 12-25
 - Transmission Filter - Shallow Pan, for 4L60E 12-25
 - Transmission Filter - Shallow Pan, for 4R100 12-25
 - Transmission Filter - for 4L80E 12-25
 - Transmission Filter - for 4R70W 12-25
 - Transmission Filter - for 5R110W, Made From November 2007 to Present . . 12-26
 - Transmission Filter Element 12-26
 - Transmission Filter Element - for 5R110W 12-26
 - Transmission Filter Pan-Type - for 5R110W, Made Before November 2007 . . 12-26
 - Transmission Filter Pan-Type - Made Before November 2007 12-26
 - Transmission Filter, Spin-On 12-26

CORBEIL

- Corbeil Air Filters** 12-27
 - Air Filter 12-27
 - Channel Flow Air Filter 12-27
 - Radial Seal Air Filter 12-27

- Corbeil Fuel Filters** 12-27
 - Fuel Filter 12-27
 - Fuel Filter - Made From 2003 to 2005, Thread Both Ends 12-27
 - Fuel Filter - Made From 2003 to 2005, Thread One End 12-27
- Corbeil Fuel/Water Separator Filters** 12-28
 - Fuel/Water Separator Filter 12-28
- Corbeil Lube/Oil Filters** 12-28
 - Lube Filter 12-28
 - Lube Filter - Made From 2003 to 2005 . . . 12-28
 - Lube Filter - Made From 2003 to 2006 . . . 12-28
 - Lube Filter - Made From 2006 to Present . 12-28
 - Lube Filter - Made From 2007 to Present . 12-28
 - Lube Filter - without Screw-On Cap. 12-28
- Corbeil Steering Filters** 12-29
 - Steering Filter 12-29
- Corbeil Transmission Filters** 12-29
 - Transmission Filter - Deep Pan, for 4L60E 12-29
 - Transmission Filter - Deep Pan, for 4R100 12-29
 - Transmission Filter - Shallow Pan, for 4L60E 12-29
 - Transmission Filter - Shallow Pan, for 4R100 12-29
 - Transmission Filter - for 4L80E 12-29
 - Transmission Filter - for 4R70W 12-29
 - Transmission Filter - for 5R110W, Made Before November 2007 12-29
 - Transmission Filter - for 5R110W, Made From November 2007 to Present 12-29
 - Transmission Filter Element 12-29
 - Transmission Filter Element - for 5R110W . 12-29
 - Transmission Filter Pan-Type - Deep Pan with Gasket 12-30
 - Transmission Filter Pan-Type - Deep Pan without Gasket 12-30
 - Transmission Filter Pan-Type - Shallow Pan with Gasket 12-30
 - Transmission Filter Pan-Type - Shallow Pan without Gasket 12-30

- Transmission Filter Pan-Type - Made Before November 2007 12-30
- Transmission Filter Pan-Type - Made From November 2007 to Present 12-30
- Transmission Filter, Spin-On 12-30

FORD

- Ford Air Filters** 12-31
 - Primary Air - Radial Seal Filter 12-31
- Ford Lube/Oil Filters** 12-31
 - Lube Filter 12-31
 - Lube Filter - without Screw-On Cap. 12-31
- Ford Transmission Filters** 12-32
 - Transmission Filter 12-32

FREIGHTLINER

- Freightliner Air Filters** 12-33
 - Air Filter 12-33
 - Channel Flow Air Filter 12-33
 - Channel Flow Air Filter - with Flame Retardant Media 12-33
 - Channel Flow Safety Air Filter 12-33
 - Disposable Air Filter Housing 12-33
 - Radial Seal Air Filter 12-33
 - Radial Seal Inner Air Filter 12-33
 - Radial Seal Outer Air Filter 12-33
 - Single Radial Seal Air Filter 12-34
- Freightliner Fuel Filters** 12-34
 - Fuel Filter 12-34
 - Fuel Filter - Made Before 2002 12-34
 - Fuel Filter - Made From 2003 to 2005, Thread Both Ends 12-34
 - Fuel Filter - Made From 2003 to 2005, Thread One End 12-34
 - Fuel Filter - Made From 2003 to Present . . 12-34
- Freightliner Fuel/Water Separator Filters** 12-35
 - Fuel/Water Separator Filter 12-35
 - Fuel/Water Separator Filter - Open End . . 12-35

- Fuel/Water Separator Filter - Open End, Spin-On 12-35
- Fuel/Water Separator Filter - with Sensor Port 12-35
- Fuel/Water Separator Filter - with Sensor Port, Spin-On 12-35
- Fuel/Water Separator Filter - without Sensor Port 12-35
- Fuel/Water Separator Filter - without Sensor Port, Spin-On 12-35
- Fuel/Water Separator Filter, Spin-On 12-35
- Optional Fuel/Water Separator Filter 12-35
- Freightliner Lube/Oil Filters** 12-36
 - Full-Flow Lube Filter 12-36
 - Lube Filter 12-36
 - Lube Filter - Made Before January 2004 . . 12-36
 - Lube Filter - Made From 2004 to Present . 12-36
 - Lube Filter - Made From 2003 to 2005 . . . 12-36
 - Lube Filter - Made From 2003 to 2006 . . . 12-36
 - Lube Filter - Made From 2006 to Present . 12-36
 - Lube Filter - Made From 2007 to Present . 12-36
 - Lube Filter - without Screw-On Cap. 12-36
- Freightliner Steering Filters** 12-37
 - Steering Filter 12-37
- Freightliner Transmission Filters** 12-37
 - Optional Transmission Filter, Spin-On . . . 12-37
 - Transmission Filter - 2000 Series, Spin-On 12-37
 - Transmission Filter - AT Series, Spin-On . . 12-37
 - Transmission Filter - Deep Pan, for 4L60E 12-37
 - Transmission Filter - Deep Pan, for 4R100 12-37
 - Transmission Filter - Shallow Pan, for 4L60E 12-37
 - Transmission Filter - Shallow Pan, for 4R100 12-37
 - Transmission Filter - for 4L80E 12-38
 - Transmission Filter - for 4R100 12-38
 - Transmission Filter - for 4R70W 12-38
 - Transmission Filter - for 5R110W 12-38

Transmission Filter - for 5R110W, Made From 2007 to Present 12-38

Transmission Filter - for E40D 12-38

Transmission Filter - Optional Oil Cooler 12-38

Transmission Filter Element 12-38

Transmission Filter Element - 2" Kit. 12-38

Transmission Filter Element - 2" Kit, 3000 Series 12-38

Transmission Filter Element - 4" Kit. 12-38

Transmission Filter Element - 4" Kit, 3000 Series. 12-38

Transmission Filter Element - for 5R110W 12-38

Transmission Filter Pan-Type - 3.8" Pan, AT Series 12-38

Transmission Filter Pan-Type - 5.3" Pan, AT Series 12-39

Transmission Filter Pan-Type - Deep Pan with Gasket. 12-39

Transmission Filter Pan-Type - Deep Pan with Gasket, 2000 Series 12-39

Transmission Filter Pan-Type - Deep Pan without Gasket 12-39

Transmission Filter Pan-Type - Deep Pan without Gasket, 2000 Series. 12-39

Transmission Filter Pan-Type - Shallow Pan with Gasket 12-39

Transmission Filter Pan-Type - Shallow Pan with Gasket, 2000 Series 12-39

Transmission Filter Pan-Type - Shallow Pan without Gasket 12-39

Transmission Filter Pan-Type - Shallow Pan without Gasket, 2000 Series 12-39

Transmission Filter Pan-Type - Made Before November 2007 12-40

Transmission Filter Pan-Type - Made From 2007 to Present 12-40

Transmission Filter, Spin-On 12-40

Gillig LLC Fuel Filters 12-41

 Primary Fuel Filter, Spin-On 12-41

Gillig LLC Fuel/Water Separator Filters 12-41

 Fuel/Water Separator Filter, Spin-On. 12-41

Gillig LLC Lube/Oil Filters 12-42

 Combination Lube Filter, Spin-On 12-42

INTERNATIONAL/IC BUS

International/IC Bus Air Filters. 12-43

 Air Filter 12-43

 Air Filter, Magnum RS 12-43

 Inner Air Filter 12-43

 Outer Air Filter 12-43

 Primary Air Filter 12-43

 Secondary Air Filter 12-43

 Radial Seal Air Filter 12-44

 Radial Seal Inner Air Filter. 12-44

 Radial Seal Outer Air Filter 12-44

 Single Air Filter. 12-44

International/IC Bus Coolant Filters 12-44

 Coolant Filter 12-44

 Coolant Filter - with 4 Units Balanced Treatment Additive Plus. 12-44

 Coolant Filter - with 6 Units Balanced Treatment Additive Plus. 12-44

 Coolant Filter - with 8 Units Balanced Treatment Additive Plus. 12-44

 Coolant Filter - with 8 Units Balanced Treatment for Ethylene Glycol 12-45

 Coolant Filter - with 12 Units Balanced Treatment Additive Plus. 12-45

 Coolant Filter - with 15 Units Balanced Treatment Additive Plus. 12-45

 Coolant Filter - without Chemicals. 12-45

International/IC Bus Fuel Filters 12-45

 Fuel Filter. 12-45

 Fuel Filter - Made From 1999 to Present. 12-46

 Fuel Filter - Made From 1994 to 1998. 12-46

 Fuel Filter - Made From 1993 to Present. 12-46

 Fuel Filter, Cartridge 12-46

GILLIG LLC

Gillig LLC Coolant Filters 12-41

 Coolant Filter, Spin-On 12-41

Fuel Filter, Spin-On 12-46

Fuel Strainer Filter 12-46

Primary Fuel Filter - Engines with S/N 567492 to 599779. 12-46

Secondary Fuel Filter - Engines with S/N 567492-on. 12-46

International/IC Bus Fuel/Water Separator Filters 12-46

Fuel/Water Separator Cartridge Filter 12-46

Fuel/Water Separator Filter 12-46

Fuel/Water Separator Filter - Box-Style. 12-47

Fuel/Water Separator Filter - Engines with S/N 618496-on. 12-47

Fuel/Water Separator Filter - with Sensor Port 12-47

Fuel/Water Separator Filter - with Sensor Port, Spin-On 12-47

Fuel/Water Separator Filter - without Sensor Port 12-47

Fuel/Water Separator Filter - without Sensor Port, Spin-On 12-47

Fuel/Water Separator Filter, Spin-On. 12-47

International/IC Bus Lube/Oil Filters 12-47

Dual-Flow Lube Filter - Made From 2005 to Present 12-47

Full-Flow Lube Filter 12-47

Full-Flow Lube Filter - Made Before 2005 12-48

Full-Flow Lube Filter, Spin-On 12-48

Lube Filter 12-48

Lube Filter - without Screw-On Cap. 12-48

Lube Filter, Cartridge 12-48

International/IC Bus Steering Filters 12-48

Power Steering Filter 12-48

Steering Filter 12-48

Steering Filter 12-48

Steering Filter - 2-25/32" 12-49

Steering Filter - 3-31/32" 12-49

Steering Filter - 5-1/32" 12-49

Steering Filter - Made Before August, 1991. 12-49

Steering Filter - Made From 1991 to Present 12-49

International/IC Bus Transmission Filters 12-49

 Transmission Filter. 12-49

 Transmission Filter Element - 2" Kit. 12-49

 Transmission Filter Element - 4" Kit. 12-50

 Transmission Filter Pan-Type 12-50

 Transmission Filter Pan-Type - 3.8" Pan 12-50

 Transmission Filter Pan-Type - 5.3" Pan 12-50

 Transmission Filter Pan-Type - Deep Pan with Gasket. 12-50

 Transmission Filter Pan-Type - Deep Pan without Gasket 12-50

 Transmission Filter Pan-Type - Shallow Pan with Gasket. 12-50

 Transmission Filter Pan-Type - Shallow Pan without Gasket 12-50

 Transmission Filter, Spin-On 12-51

MID BUS

Mid Bus Air Filters 12-52

 Air Filter 12-52

 Channel Flow Air Filter. 12-52

 Radial Seal Air Filter 12-52

Mid Bus Fuel Filters 12-52

 Fuel Filter. 12-52

 Fuel Filter - Made From 2003 to 2005, Thread Both Ends 12-52

 Fuel Filter - Made From 2003 to 2005, Thread One End 12-52

Mid Bus Fuel/Water Separator Filters. 12-53

 Fuel/Water Separator Filter 12-53

Mid Bus Lube/Oil Filters 12-53

 Lube Filter 12-53

 Lube Filter - Made From 2003 to 2005 12-53

 Lube Filter - Made From 2003 to 2006 12-53

 Lube Filter - Made From 2006 to Present 12-53

 Lube Filter - Made From 2007 to Present 12-53

 Lube Filter - without Screw-On Cap. 12-53

Mid Bus Steering Filters 12-54

 Steering Filter 12-54

Mid Bus Transmission Filters 12-54

Transmission Filter - Deep Pan, for 4L60E 12-54

Transmission Filter - Deep Pan, for 4R100 12-54

Transmission Filter - Shallow Pan, for 4L60E 12-54

Transmission Filter - Shallow Pan, for 4R100 12-54

Transmission Filter - for 4L80E 12-54

Transmission Filter - for 4R70W 12-54

Transmission Filter - for 5R110W, Made Before November 2007 12-54

Transmission Filter - for 5R110W, Made From 2007 to Present 12-54

Transmission Filter Element 12-55

Transmission Filter Element - for 5R110W 12-55

Transmission Filter Pan-Type - Deep Pan with Gasket 12-55

Transmission Filter Pan-Type - Deep Pan without Gasket 12-55

Transmission Filter Pan-Type - Shallow Pan with Gasket 12-55

Transmission Filter Pan-Type - Shallow Pan without Gasket 12-55

Transmission Filter Pan-Type - Made Before November 2007 12-55

Transmission Filter Pan-Type - Made From 2007 to Present 12-55

Transmission Filter, Spin-On 12-55

THOMAS BUILT

Thomas Built Air Filters 12-56

Channel Flow Air Filter 12-56

Channel Flow Air Filter - with Flame Retardant Media 12-56

Channel Flow Safety Air Filter 12-56

Disposable Air Filter Housing 12-56

Optional Standard Inner Air Filter 12-56

Radial Seal Air Filter 12-57

Standard Outer Air Filter 12-57

Thomas Built Coolant Filters 12-57

Coolant Filter - with Chemical 12-57

Coolant Filter - without Chemical 12-57

Thomas Built Fuel Filters 12-57

Fuel Element Filter - Made From 1996 to Present 12-57

Fuel Filter 12-57

Fuel Filter - Made From 2007 to Present 12-58

Primary Fuel Filter, Spin-On 12-58

Thomas Built Fuel/Water Separator Filters 12-58

Fuel/Water Separator Element Filter - Davco 382 System 12-58

Fuel/Water Separator Filter 12-58

Fuel/Water Separator Filter - Made Before 1995, with Sensor Port 12-58

Fuel/Water Separator Filter - Made Before 1995, without Sensor Port 12-58

Fuel/Water Separator Filter, Spin-On 12-58

Optional Fuel/Water Separator Filter 12-58

Thomas Built Lube/Oil Filters 12-59

Dual-Flow Lube Filter 12-59

Full-Flow Lube Filter, Spin-On 12-59

Lube Element Filter 12-59

Lube Filter 12-59

Lube Filter - Made Before 1994 12-59

Lube Filter - Made Before 1995 12-59

Lube Filter - Made Before January 2004 12-59

Lube Filter - Made From 1994 to Present 12-59

Lube Filter - Made From 2004 to Present 12-59

Lube Filter, Spin-On 12-59

Thomas Built Steering Filters 12-60

Steering Filter 12-60

Thomas Built Transmission Filters 12-60

Optional Transmission Filter, Spin-On 12-60

Transmission Filter - for 1000 & 2000 Series, Spin-On 12-60

Transmission Filter - for AT & MT Series, Spin-On 12-60

Transmission Filter Element - 2" Kit, 3000 & 4000 Series 12-61

Transmission Filter Element - 4" Kit, 3000 & 4000 Series 12-61

Transmission Filter Pan-Type - 3.8" Pan 12-61

Transmission Filter Pan-Type - 3.8" Pan, AT Series 12-61

Transmission Filter Pan-Type - 5.3" Pan 12-61

Transmission Filter Pan-Type - 5.3" Pan, AT & MT Series 12-61

Transmission Filter Pan-Type - Deep Pan with Gasket, 1000 & 2000 Series 12-62

Transmission Filter Pan-Type - Deep Pan without Gasket, 1000 & 2000 Series 12-62

Transmission Filter Pan-Type - Shallow Pan with Gasket, 1000 & 2000 Series 12-62

Transmission Filter Pan-Type - Shallow Pan without Gasket, 1000 & 2000 Series 12-62

Transmission Filter, Spin-On 12-62

Water Filter, Spin-On 12-67

VAN HOOL

Van Hool Air Filters 12-63

Primary Air Filter 12-63

Secondary Air Filter, Magnum RS 12-63

Van Hool Air/Oil Separator Filters 12-63

Air/Oil Separator Filter 12-63

Van Hool Fuel Filters 12-64

Fuel Filter 12-64

Fuel Filter, Cartridge 12-64

Fuel Filter, Spin-On 12-64

Fuel Filter, User-Friendly Version 12-64

Van Hool Fuel/Water Separator Filters 12-65

Fuel/Water Separator Filter, Spin-On 12-65

Van Hool Hydraulic Filters 12-65

Hydraulic Filter, Cartridge 12-65

Van Hool Lube/Oil Filters 12-65

Lube Centrifugal By-Pass Filter 12-65

Lube Filter 12-66

Lube Filter, Cartridge 12-66

Lube Filter, Spin-On 12-66

Van Hool Steering Filters 12-66

Van Hool Water Filters 12-67

FBO Series

For Fuel Dispensing



Racor's FBO filter assembly is designed to meet the toughest refueling conditions; helping to protect the latest high-pressure common-rail diesel injection components and extending onboard filter life.

The high capacity filter cartridge captures contaminants down to 25 microns, and free water from diesel and biodiesel blends, before they reach the fuel tank.

The assembly features a "locking ring collar" which attaches the filter housing to the aluminum die cast filter head with four bolts tightened with hand knobs. No wrenches or other special tools are required, allowing *one person* to easily change the filter cartridge.

The FB01025M includes Delta P gauge (change filter at 15 PSID), water sight glass, water drain valve, and 25 micron filter cartridge. This assembly is rated at 25 gpm flow for diesel fuel when using silicone treated filter.



Product Features

- Die-Cast Aluminum Head
- Steel Bowl Assembly
- Powder Coated Components
- Locking Ring Collar (no v-clamps)
Allows one person to easily change the filter cartridge.
- 1.5" NPT Inlet and Outlet Ports
- Differential Pressure Gauge, Sight Glass, and Drain Valve (Included)
- 25 micron Cartridge Filter (Included)
- Mounting Bracket with two 1-1/2" NPT male/female fittings (Required)
- Dimensions:
Height - 20.5 in. (52.1 cm)
Width - 11.0 in. (27.9 cm)
Depth - 9.8 in. (24.9 cm)



FBO Commercial Application
External mounted FBO shown.
Can be mounted internally or on a stand.

Mounting Bracket Kit
Racor part # **73084**
(includes two 1 1/2" NPT male/female fittings)

Contact Information

Parker Hannifin Corporation
Racor Division
P.O. Box 3208
3400 Finch Road
Modesto, CA 95353

phone 800 344 3286
209 521 7860
fax 209 529 3278
racor@parker.com

www.parker.com/racor

To Order:

Part #	Includes:			
FB01025M	Delta-P Gauge	25 micron Filter	Sight Glass	Drain Valve
73084 (Required)	Mounting Bracket	(2) 1 1/2" NPT Male/Female Fittings		



ENGINEERING YOUR SUCCESS.

BLUE BIRD

BLUE BIRD AIR FILTERS

Table 12-1: Air Filters for Blue Bird

OEM Part Number	Manufacturer	Engine Make/Model	Baldwin	Fleetguard	Donaldson
AIR FILTER					
F50Y9601A	Blue Bird	Micro Bird with Ford 6.8L Engine		AF25590FLG	
F50Y9601A	Blue Bird	Micro Bird with Ford 6.8L Engine		AF26303FLG	
4C2U9601AB	Blue Bird	Micro Bird with Ford 6.0L Engine		AF26374FLG	
88937527	Blue Bird	Micro Bird with GMC 6.6L Engine		AF26667FLG	
88937527	Blue Bird	Micro Bird with GMC V6-292 4.8L Gas Engine		AF26667FLG	
88937527	Blue Bird	Micro Bird with GMC V8-366 6.0L Engine		AF26667FLG	
29540976	Blue Bird	TC 2000 with Caterpillar 3116 Engine		HF28943FLG	
29540976	Blue Bird	TC 2000 with Cummins 6BT 5.9L Engine		HF28943FLG	
4298501	Blue Bird	TC 2000 with Caterpillar 3116 Engine	PA3474JAB		
4298501	Blue Bird	TC 2000 with Cummins ISB Engine	PA3474JAB		
4298501	Blue Bird	TC 2000 with Cummins 6BT 5.9L Diesel Engine	PA3474JAB		
1967744	Blue Bird	All-American with Caterpillar C7 Engine	PA3987JAB		
1967744	Blue Bird	All-American with Caterpillar 3126 Engine	PA3987JAB		
1967744	Blue Bird	All-American with Cummins ISB 5.9L Engine	PA3987JAB		
1967744	Blue Bird	All-American with Cummins ISC Engine	PA3987JAB		
1967744	Blue Bird	All-American with John Deere 6081 8.1L Clear Natural Gas Engine	PA3987JAB		
FA1632	Blue Bird	Micro Bird with Ford 6.8L Gas Engine	PA4075JAB		
FA1804	Blue Bird	Micro Bird with Ford 6.0L Turbo Diesel Engine	PA4171JAB		

RADIAL SEAL AIR FILTER

A2032C	Blue Bird	Micro Bird with GMC 4.8L Gas Engine	RS4859JAB		
A2032C	Blue Bird	Micro Bird with GMC 6.0L Gas Engine	RS4859JAB		
A2032C	Blue Bird	Micro Bird with GMC 6.6L Turbo Diesel Engine	RS4859JAB		
87782	Blue Bird	Vision with Caterpillar C7 Engine	RS5458JAB		
87782	Blue Bird	Vision with Cummins ISB Engine	RS5458JAB		
87782	Blue Bird	Vision with Cummins ISC Engine	RS5458JAB		
87782	Blue Bird	Vision with GMC 8.1L Natural Gas Engine	RS5458JAB		

BLUE BIRD COOLANT FILTERS

Table 12-2: Coolant Filters for Blue Bird

OEM Part Number	Manufacturer	Engine Make/Model	Baldwin	Fleetguard	Donaldson
COOLANT FILTER					
24070	Blue Bird	Vision with Caterpillar C7 Engine	B5134JAB		
64641	Blue Bird	All-American, Vision with Caterpillar C7 Engine	B5134JAB		
64641	Blue Bird	All-American, Vision with Caterpillar 3126 Engine	B5134JAB		
64641	Blue Bird	All-American, Vision with Cummins ISB 5.9L Engine	B5134JAB		
64641	Blue Bird	All-American, Vision with Cummins ISC Engine	B5134JAB		
64641	Blue Bird	All-American with John Deere 6081 8.1L Clear Natural Gas Engine	B5134JAB		

COOLANT FILTER, SPIN-ON

WF2071	Blue Bird	All-American with Cummins ISC Engine			P552071
3300721	Blue Bird	All-American with Cummins ISB 5.9L Engine		WF2070FLG	
3300721	Blue Bird	All-American, Vision with Cummins ISC Engine		WF2070FLG	
9Y4528	Blue Bird	All-American with Caterpillar 3126 Engine		WF2077FLG	
9Y4528	Blue Bird	All-American, Vision with Caterpillar C7 Engine		WF2077FLG	
9Y4528	Blue Bird	All-American with John Deere 6081 Engine		WF2077FLG	
9Y4528	Blue Bird	Vision with Caterpillar 3126E Engine		WF2077FLG	
9Y4528	Blue Bird	Vision with Cummins ISB Engine		WF2077FLG	

BLUE BIRD FUEL FILTERS

Table 12-3: Fuel Filters for Blue Bird

OEM Part Number	Manufacturer	Engine Make/Model	Baldwin	Fleetguard	Donaldson
FUEL FILTER					
3959612	Blue Bird	All-American, Vision with Cummins ISC Engine		FF5488FLG	
25121293	Blue Bird	Micro Bird with GMC V8-366 6.0L Engine		FF5503FLG	
4934845	Blue Bird	All-American with Cummins ISB 5.9L Engine	BF7940JAB	FF5632FLG	
4934845	Blue Bird	Transit with Cummins ISB07 Engine		FF5632FLG	
4940647	Blue Bird	All-American with Cummins ISC Engine		FF5636FLG	
4940647	Blue Bird	Transit with Cummins ISB07 Engine		FF5636FLG	
25012015	Blue Bird	Micro Bird with GMC 4.8L Gas Engine	BF719JAB		
1R0751	Blue Bird	All-American, Vision with Caterpillar C7 Engine	BF7632JAB		
1R0751	Blue Bird	All-American, Vision with Caterpillar 3126 Engine	BF7632JAB		
1R0750	Blue Bird	TC 2000 with Caterpillar 3116 Engine	BF7633JAB FF5320JAB		
60586	Blue Bird	All-American, Vision with Caterpillar C7 Engine	BF7634JAB		

OEM Part Number	Manufacturer	Engine Make/Model	Baldwin	Fleetguard	Donaldson
60586	Blue Bird	All-American with Caterpillar 3126 Engine	BF7634JAB		
FG986B	Blue Bird	Micro Bird with Ford 6.8L Gas Engine	BF7668JAB		
FF5488	Blue Bird	All-American, Vision with Cummins ISC Engine	BF7815JAB		
98017645	Blue Bird	Micro Bird with GMC 6.6L Engine	BF7827JAB		
3903640	Blue Bird	TC 2000 with Cummins 6BT 5.9L Diesel Engine	BF788JAB		
FF5636	Blue Bird	All-American with Cummins ISC Engine	BF7924JAB		
FF5632	Blue Bird	Vision with Cummins ISB Engine	BF7940JAB		
FD4604	Blue Bird	Micro Bird with Ford 6.0L Turbo Diesel Engine	PF7812K1T-JAB		

FUEL FILTER - MADE FROM 2003 TO 2005, THREAD BOTH ENDS

GF481	Blue Bird	Micro Bird with GMC 6.0L Gas Engine	BF583JAB		
-------	-----------	-------------------------------------	----------	--	--

FUEL FILTER - MADE FROM 2003 TO 2005, THREAD ONE END

GF578	Blue Bird	Micro Bird with GMC 6.0L Gas Engine	BF1171JAB		
-------	-----------	-------------------------------------	-----------	--	--

FUEL FILTER, IN-LINE

25171792	Blue Bird	Micro Bird with GMC V8-366 6.0L Engine		FF5026FLG	
F89Z9155A	Blue Bird	Micro Bird with Ford 6.8L Engine		FF5455FLG	

FUEL FILTER, SPIN-ON

23518527	Blue Bird	All-American with Detroit Diesel 8.2L Engine		FF235FLG	
25012015	Blue Bird	Micro Bird with GMC V6-292 4.8L Gas Engine		FF4136FLG	
3903640	Blue Bird	All-American with Cummins 8.3L Engine		FF42000FLG FF5052FLG	
3903640	Blue Bird	TC 2000 with Cummins 6BT 5.9L Engine		FF42000FLG FF5052FLG	
23518526	Blue Bird	All-American with Detroit Diesel 8.2L Engine		FF5021FLG	
1R0751	Blue Bird	All-American, Vision with Caterpillar 3126 Engine		FF5324FLG	
1R0751	Blue Bird	All-American, Vision with Caterpillar C7 Engine		FF5324FLG	
1R0759	Blue Bird	Vision with Caterpillar C7 Engine		FF5324FLG	

FUEL FILTER/WATER SEPARATOR CARTRIDGE

3C3Z9N184CA	Blue Bird	Micro Bird with Ford 6.0L Engine		FS19797FLG	
-------------	-----------	----------------------------------	--	------------	--

PRIMARY FUEL FILTER, SPIN-ON

FF5632	Blue Bird	All-American with Cummins ISB 5.9L Engine			P550880
FF5632	Blue Bird	TC 2000, Vision with Cummins ISB Engine			P550880
FF5636	Blue Bird	All-American with Cummins ISC Engine			P550879
FS1065	Blue Bird	All-American with Cummins ISB 5.9L Engine			P551103
FS1065	Blue Bird	All-American with Cummins ISC Engine			P551103
FS1065	Blue Bird	TC 2000 with Cummins ISB Engine			P551103
FS1065	Blue Bird	Vision with Cummins ISB Engine			P551103

OEM Part Number	Manufacturer	Engine Make/Model	Baldwin	Fleetguard	Donaldson
-----------------	--------------	-------------------	---------	------------	-----------

SECONDARY FUEL FILTER, SPIN-ON

No OEM number available	Blue Bird	TC 2000 with Cummins 6BT 5.9L Diesel Engine			P550440 P550248 P551329 P558615
No OEM number available	Blue Bird	TC 2000 with Cummins 6BTA 5.9L Diesel Engine			P550440 P550248 P551329 P558615

BLUE BIRD FUEL/WATER SEPARATOR FILTERS

Table 12-4: Fuel/Water Separator Filters for Blue Bird

OEM Part Number	Manufacturer	Engine Make/Model	Baldwin	Fleetguard	Donaldson
-----------------	--------------	-------------------	---------	------------	-----------

FUEL/WATER SEPARATOR FILTER

3942470	Blue Bird	TC 2000 with Cummins ISB Engine			FS19855FLG
4070801	Blue Bird	Transit with Cummins ISB07 Engine			FS1003FLG
4934879	Blue Bird	Transit with Cummins ISB07 Engine			FS1065FLG
6N7617	Blue Bird	TC 2000 with Caterpillar 3116 Engine	BF912JAB		FS1205FLG
3903202	Blue Bird	TC 2000 with Cummins 6BT 5.9L Diesel Engine	BF1226JAB		FS1251FLG
3925274	Blue Bird	TC 2000 with Cummins 6BT 5.9L Diesel Engine	BF1280JAB		FS1280FLG
1967009	Blue Bird	Vision with Caterpillar C7 Engine			FS19932FLG
S3230	Blue Bird	All-American with Caterpillar C7 Engine	BF1252JAB		
S3230	Blue Bird	All-American with Cummins ISC Engine	BF1252JAB		
FS1003	Blue Bird	All-American with Cummins ISC Engine	BF1293SPS JAB		P551103
R90S	Blue Bird	All-American, Vision with Caterpillar C7 Engine	BF1360SPJAB		
R90S	Blue Bird	All-American, Vision with Caterpillar 3126 Engine	BF1360SPJAB		
R90S	Blue Bird	All-American, Vision with Cummins ISB 5.9L Engine	BF1360SPJAB		
R90S	Blue Bird	All-American, Vision with Cummins ISC Engine	BF1360SPJAB		
4934879	Blue Bird	All-American with Caterpillar C7 Engine	BF1378SPS JAB		
98017645	Blue Bird	Micro Bird with GMC 6.6L Turbo Diesel Engine	BF7827JAB		

FUEL/WATER SEPARATOR FILTER - OPEN END

R90P	Blue Bird	All-American, Vision with Caterpillar C7 Engine	BF13290JAB		
R90P	Blue Bird	All-American, Vision with Caterpillar 3126 Engine	BF13290JAB		
R90P	Blue Bird	All-American, Vision with Cummins ISC Engine	BF13290JAB		
R90-BB-02	Blue Bird	All-American with Cummins ISC Engine	BF13290JAB		
R90T	Blue Bird	All-American, Vision with Caterpillar C7 Engine	BF13900JAB		
R90T	Blue Bird	All-American, Vision with Caterpillar 3126 Engine	BF13900JAB		
R90T	Blue Bird	All-American, Vision with Cummins ISC Engine	BF13900JAB		

OEM Part Number	Manufacturer	Engine Make/Model	Baldwin	Fleetguard	Donaldson
-----------------	--------------	-------------------	---------	------------	-----------

FUEL/WATER SEPARATOR FILTER - OPEN END, SPIN-ON

R90-BB-02	Blue Bird	All-American with Cummins ISB 5.9L Engine	BF13290JAB		
R90P	Blue Bird	All-American, Vision with Cummins ISB 5.9L Engine	BF13290JAB		
R90T	Blue Bird	All-American, Vision with Cummins ISB 5.9L Engine	BF13900JAB		

FUEL/WATER SEPARATOR FILTER - RECTANGLE SENSOR, SPIN-ON

3800394	Blue Bird	All-American, TC 2000 with Cummins ISB Engine			FS1022FLG
---------	-----------	---	--	--	-----------

FUEL/WATER SEPARATOR FILTER - WITH 1/2-20 SENSOR PORT THREAD, SPIN-ON

R90P	Blue Bird	All-American, Vision with Cummins ISB 5.9L Engine	BF1339SPJAB		
------	-----------	---	-------------	--	--

FUEL/WATER SEPARATOR FILTER - WITH 9/16-18 SENSOR PORT THREAD

R90-BB-02	Blue Bird	All-American with Cummins ISC Engine	BF1329SPJAB		
R90P	Blue Bird	All-American, Vision with Caterpillar C7 Engine	BF1329SPJAB		
R90P	Blue Bird	All-American, Vision with Caterpillar 3126 Engine	BF1329SPJAB		
R90P	Blue Bird	All-American, Vision with Cummins ISC Engine	BF1329SPJAB		

FUEL/WATER SEPARATOR FILTER - WITH 9/16-18 SENSOR PORT THREAD, SPIN-ON

n/a	Blue Bird	All-American with Cummins ISB 5.9L Engine	BF1329SPJAB		
R90-BB-02	Blue Bird	All-American with Cummins ISB 5.9L Engine	BF1329SPJAB		

FUEL/WATER SEPARATOR FILTER - WITH SENSOR PORT

S3225P	Blue Bird	All-American with Caterpillar C7 Engine	BF1348SPJAB		
S3225P	Blue Bird	All-American with Caterpillar 3126 Engine	BF1348SPJAB		

FUEL/WATER SEPARATOR FILTER - WITHOUT SENSOR PORT

R90P	Blue Bird	All-American, Vision with Caterpillar C7 Engine	BF1329JAB		
R90P	Blue Bird	All-American, Vision with Caterpillar 3126 Engine	BF1329JAB		
R90P	Blue Bird	All-American, Vision with Cummins ISC Engine	BF1329JAB		
S3225P	Blue Bird	All-American with Caterpillar C7 Engine	BF1348JAB		
S3225P	Blue Bird	All-American with Caterpillar 3126 Engine	BF1348JAB		
4299582	Blue Bird	All-American with Cummins ISC Engine	BF1348JAB BF1348SPJAB		

FUEL/WATER SEPARATOR FILTER - WITHOUT SENSOR PORT, SPIN-ON

R90-BB-02	Blue Bird	All-American with Cummins ISB 5.9L Engine	BF1329JAB		
R90P	Blue Bird	All-American, Vision with Cummins ISB 5.9L Engine	BF1329JAB		
4299582	Blue Bird	All-American with Cummins ISB 5.9L Engine	BF1348JAB BF1348SPJAB		

FUEL/WATER SEPARATOR FILTER - WITH DRAIN

R90T	Blue Bird	All-American, Vision with Caterpillar C7 Engine	BF1349JAB		
R90T	Blue Bird	All-American, Vision with Caterpillar 3126 Engine	BF1349JAB		
R90T	Blue Bird	All-American, Vision with Cummins ISC Engine	BF1349JAB		

OEM Part Number	Manufacturer	Engine Make/Model	Baldwin	Fleetguard	Donaldson
-----------------	--------------	-------------------	---------	------------	-----------

FUEL/WATER SEPARATOR FILTER - WITH DRAIN, SPIN-ON

R90T	Blue Bird	All-American, Vision with Cummins ISB 5.9L Engine	BF1349JAB		
------	-----------	---	-----------	--	--

FUEL/WATER SEPARATOR FILTER ELEMENT

FS19579	Blue Bird	TC 2000 with Cummins ISB Engine	PF7777JAB		
FS19800	Blue Bird	All-American with Cummins ISB 5.9L Engine	PF7977JAB		

FUEL/WATER SEPARATOR FILTER, SPIN-ON

4309159	Blue Bird	TC 2000 with Cummins ISB Engine	BF1252JAB	FS19592FLG	
S3230	Blue Bird	All-American with Cummins ISB 5.9L Engine	BF1252JAB		
FS1022	Blue Bird	All-American with Cummins ISB 5.9L Engine	BF1272SPSJAB		
1966993	Blue Bird	All-American with Cummins ISB 5.9L Engine	BF1349JAB		
3903202	Blue Bird	All-American with Cummins 8.3L Engine		FS1251FLG	
3925274	Blue Bird	All-American with Cummins 8.3L Engine		FS1280FLG	
23514654	Blue Bird	All-American with Caterpillar 3126 Engine		FS19551FLG	
23514654	Blue Bird	All-American with Caterpillar C7 Engine		FS19551FLG	
12542374	Blue Bird	All-American with Detroit Diesel 8.2L Engine		FS19965FLG	
3406889	Blue Bird	All-American with Cummins ISC Engine	FS1003JAB		

BLUE BIRD LUBE/OIL FILTERS

Table 12-5: Lube/Oil Filters for Blue Bird

OEM Part Number	Manufacturer	Engine Make/Model	Baldwin	Fleetguard	Donaldson
-----------------	--------------	-------------------	---------	------------	-----------

COMBINATION LUBE FILTER, SPIN-ON

LF9548	Blue Bird	All-American with Cummins ISC Engine			P553548
--------	-----------	--------------------------------------	--	--	---------

DUAL-FLOW LUBE FILTER

97148270	Blue Bird	Micro Bird with GMC 4.8L Gas Engine	BD7169JAB		
LF9009	Blue Bird	All-American, Vision with Cummins ISC Engine	BD7309JAB		P553000

FULL-FLOW LUBE FILTER, SPIN-ON

LF3970	Blue Bird	All-American, TC 2000, Vision with Cummins ISB 5.9L Engine			P550428
3937144	Blue Bird	All-American, TC 2000, Vision with Cummins ISB Engine	B7177JAB	LF3970FLG	
F1AZ6731A	Blue Bird	Micro Bird with Ford 6.8L Engine		LF16214FLG	
3908615	Blue Bird	TC 2000 with Cummins 6BT 5.9L Engine		LF3349FLG	
F1AZ6731A	Blue Bird	Micro Bird with Ford 6.8L Engine		LF3681FLG	
23518668	Blue Bird	All-American with Detroit Diesel 8.2L Engine		LF653FLG	
1R0739	Blue Bird	All-American with Caterpillar 3126 Engine		LF667FLG	

CLN&R*JAB stands for clean and reuse present filter.

OEM Part Number	Manufacturer	Engine Make/Model	Baldwin	Fleetguard	Donaldson
-----------------	--------------	-------------------	---------	------------	-----------

1R0739	Blue Bird	All-American, Vision with Caterpillar C7 Engine		LF667FLG	
1R0739	Blue Bird	TC 2000 with Caterpillar 3116 Engine		LF667FLG	
1R0739	Blue Bird	Vision with Caterpillar 3126E Engine		LF667FLG	
3313281	Blue Bird	All-American with Cummins 8.3L Engine		LF734FLG	

LUBE ELEMENT FILTER

RE509672	Blue Bird	All-American with John Deere 6081 8.1L Clear Natural Gas Engine	P7233JAB		
n/a	Blue Bird	Vision with GMC 8.1L Natural Gas Engine	P7233JAB BT486JAB CLN&R*JAB		

LUBE FILTER

4309159	Blue Bird	All-American with Cummins ISB 5.9L Engine		FS19592FLG	
97214983	Blue Bird	Micro Bird with GMC 6.6L Engine		LF16102FLG	
3C3Z6731AA	Blue Bird	Micro Bird with Ford 6.0L Engine		LF16166FLG	
89017524	Blue Bird	Micro Bird with GMC V8-366 6.0L Engine		LF16242FLG	
1R1807	Blue Bird	All-American, Vision with Caterpillar 3126 Engine		LF3379FLG	
1R1807	Blue Bird	All-American, Vision with Caterpillar C7 Engine		LF3379FLG	
3937736	Blue Bird	Transit with Cummins ISB07 Engine		LF3970FLG	
88984215	Blue Bird	Micro Bird with GMC V8-366 6.0L Engine		LF42502FLG	
1R1808	Blue Bird	All-American with Caterpillar C7 Engine	B7299JAB	LF691AFLG	
1R1808	Blue Bird	Vision with Caterpillar C7 Engine	B7299JAB	LF691AFLG	
88984215	Blue Bird	Micro Bird with GMC V8-366 6.0L Engine		LF796FLG	
3973686	Blue Bird	Transit with Cummins ISB07 Engine		LF9548FLG	
PF2232	Blue Bird	Micro Bird with GMC 6.6L Turbo Diesel Engine	B1441JAB		
FL820S	Blue Bird	Micro Bird with Ford 6.8L Gas Engine	B329JAB		
LF3970	Blue Bird	All-American, Vision with Cummins ISB 5.9L Engine	B7177JAB		
1R0739	Blue Bird	TC 2000 with Caterpillar 3116 Engine	B7600JAB		

LUBE FILTER - MADE BEFORE JANUARY 2004

1R0739	Blue Bird	All-American, Vision with Caterpillar C7 Engine	B7600JAB		
1R0739	Blue Bird	All-American with Caterpillar 3126 Engine	B7600JAB		
1R0739	Blue Bird	Vision with Caterpillar 3126E Engine	B7600JAB		

LUBE FILTER - MADE FROM JANUARY 2004 TO PRESENT

1R1807	Blue Bird	All-American, Vision with Caterpillar C7 Engine	B7700JAB		
1R1807	Blue Bird	All-American, Vision with Caterpillar 3126 Engine	B7700JAB		

LUBE FILTER - MADE FROM 2003 TO 2006

88984215	Blue Bird	Micro Bird with GMC 6.0L Gas Engine	B31JAB		
----------	-----------	-------------------------------------	--------	--	--

LUBE FILTER - MADE FROM 2007 TO PRESENT

PF48	Blue Bird	Micro Bird with GMC 6.0L Gas Engine	B160JAB		
------	-----------	-------------------------------------	---------	--	--

CLN&R*JAB stands for clean and reuse present filter.

OEM Part Number	Manufacturer	Engine Make/Model	Baldwin	Fleetguard	Donaldson
-----------------	--------------	-------------------	---------	------------	-----------

LUBE FILTER - WITHOUT SCREW-ON CAP

FL2016	Blue Bird	Micro Bird with Ford 6.0L Turbo Diesel Engine	P7235JAB		
--------	-----------	---	----------	--	--

LUBE FILTER, CARTRIDGE

RE509672	Blue Bird	All-American with John Deere 6081 Engine		LF16043FLG	
----------	-----------	--	--	------------	--

LUBE FILTER, COMBINATION

3401544	Blue Bird	All-American, Vision with Cummins ISC Engine		LF9009FLG	
3401544	Blue Bird	Transit with Cummins ISB07 Engine		LF9009FLG	

LUBE FILTER, SPIN-ON

3318853	Blue Bird	All-American with Cummins 8.3L Engine		LF3000FLG	
97148270	Blue Bird	Micro Bird with GMC V6-292 4.8L Gas Engine		LF3854FLG	
RE57394	Blue Bird	All-American with John Deere 6081 8.1L Clear Natural Gas Engine	BT486JAB	LF3567FLG	

CLN&R*JAB stands for clean and reuse present filter.

BLUE BIRD TRANSMISSION FILTERS

Table 12-6: Transmission Filters for Blue Bird

OEM Part Number	Manufacturer	Engine Make/Model	Baldwin	Fleetguard	Donaldson
-----------------	--------------	-------------------	---------	------------	-----------

TRANSMISSION FILTER

29540976	Blue Bird	All-American with Caterpillar 3126 Engine		HF28943FLG	
29540976	Blue Bird	All-American with Caterpillar C7 Engine		HF28943FLG	
29540976	Blue Bird	All-American with Cummins ISB 5.9L Engine		HF28943FLG	
29540976	Blue Bird	All-American with Cummins ISC Engine		HF28943FLG	
29540976	Blue Bird	All-American with John Deere 6081 Engine		HF28943FLG	
29540976	Blue Bird	TC 2000 with Cummins ISB Engine		HF28943FLG	
29540493	Blue Bird	All-American with Caterpillar 3126 Engine		HF35153FLG	
29540493	Blue Bird	All-American, Vision with Caterpillar C7 Engine		HF35153FLG	
29540493	Blue Bird	All-American with Cummins ISB 5.9L Engine		HF35153FLG	
29540493	Blue Bird	All-American, Vision with Cummins ISC Engine		HF35153FLG	
29540493	Blue Bird	All-American with John Deere 6081 Engine		HF35153FLG	
29540493	Blue Bird	Vision with Caterpillar 3126E Engine		HF35153FLG	
29540493	Blue Bird	Vision with Cummins ISB Engine		HF35153FLG	
29540493	Blue Bird	Vision with GMC 8.1L Engine		HF35153FLG	
29539579	Blue Bird	All-American, Vision with Caterpillar C7 Engine	PT9416MPGK1TJAB	HF35296FLG	
29539579	Blue Bird	All-American with Cummins ISB 5.9L Engine	PT9416MPGK1TJAB	HF35296FLG	
29539579	Blue Bird	All-American, Vision with Cummins ISC Engine	PT9416MPGK1TJAB	HF35296FLG	
29539579	Blue Bird	Vision with Caterpillar 3126E Engine	PT9416MPGK1TJAB	HF35296FLG	
29539579	Blue Bird	Vision with Cummins ISB Engine	PT9416MPGK1TJAB	HF35296FLG	
29537268	Blue Bird	Micro Bird with GMC 6.6L Engine		HF35296FLG	

OEM Part Number	Manufacturer	Engine Make/Model	Baldwin	Fleetguard	Donaldson
-----------------	--------------	-------------------	---------	------------	-----------

29537268	Blue Bird	Micro Bird with GMC V6-292 4.8L Gas Engine		HF35296FLG	
29537268	Blue Bird	Micro Bird with GMC V8-366 6.0L Engine		HF35296FLG	
29537268	Blue Bird	Vision with Caterpillar C7 Engine		HF35296FLG	
29539579	Blue Bird	All-American with John Deere 6081 Engine		HF35296FLG	
29539579	Blue Bird	Vision with GMC 8.1L Engine		HF35296FLG	
29538489	Blue Bird	All-American, Vision with Caterpillar C7 Engine	BT8460JAB	TF15002FLG	
29538489	Blue Bird	All-American with Cummins ISB 5.9L Engine	BT8460JAB	TF15002FLG	
29538489	Blue Bird	All-American, Vision with Cummins ISC Engine	BT8460JAB	TF15002FLG	
29538489	Blue Bird	TC 2000, Vision with Cummins ISB Engine	BT8460JAB	TF15002FLG	
29538489	Blue Bird	All-American with Caterpillar 3126 Engine		TF15002FLG	
29538489	Blue Bird	All-American with John Deere 6081 Engine		TF15002FLG	
29538489	Blue Bird	TC 2000 with Caterpillar 3116 Engine		TF15002FLG	
29538489	Blue Bird	TC 2000 with Cummins 6BT 5.9L Engine		TF15002FLG	
29537966	Blue Bird	All-American with Caterpillar 3126 Engine	19739JAB	TF15082AFLG	
29537966	Blue Bird	All-American, Vision with Caterpillar C7 Engine	19739JAB	TF15082AFLG	
29537966	Blue Bird	All-American with Cummins ISB 5.9L Engine	19739JAB	TF15082AFLG	
29537966	Blue Bird	All-American, Vision with Cummins ISC Engine	19739JAB	TF15082AFLG	
29537966	Blue Bird	TC 2000, Vision with Cummins ISB Engine	19739JAB	TF15082AFLG	
29537966	Blue Bird	All-American with John Deere 6081 Engine		TF15082AFLG	
29537966	Blue Bird	Micro Bird with GMC 6.6L Engine		TF15082AFLG	
29537966	Blue Bird	Micro Bird with GMC V6-292 4.8L Gas Engine		TF15082AFLG	
29537966	Blue Bird	Micro Bird with GMC V8-366 6.0L Engine		TF15082AFLG	
29537966	Blue Bird	Vision with Caterpillar 3126E Engine		TF15082AFLG	
29537966	Blue Bird	Vision with GMC 8.1L Engine		TF15082AFLG	
29537965	Blue Bird	All-American with Caterpillar 3126 Engine		TF15085FLG	
29537965	Blue Bird	All-American, Vision with Caterpillar C7 Engine		TF15085FLG	
29537965	Blue Bird	All-American with Cummins ISB 5.9L Engine		TF15085FLG	
29537965	Blue Bird	All-American, Vision with Cummins ISC Engine		TF15085FLG	
29537965	Blue Bird	All-American with John Deere 6081 Engine		TF15085FLG	
29537965	Blue Bird	Micro Bird with GMC 6.6L Engine		TF15085FLG	
29537965	Blue Bird	Micro Bird with GMC V6-292 4.8L Gas Engine		TF15085FLG	
29537965	Blue Bird	Micro Bird with GMC V8-366 6.0L Engine		TF15085FLG	
29537965	Blue Bird	Vision with Caterpillar 3126E Engine		TF15085FLG	
29537965	Blue Bird	Vision with Cummins ISB Engine		TF15085FLG	
29537965	Blue Bird	Vision with GMC 8.1L Engine		TF15085FLG	
3C3P7G186AF	Blue Bird	Micro Bird with Ford 6.8L Engine		TF15086FLG	
3C3Z7A098AA	Blue Bird	Micro Bird with Ford 6.0L Engine		TF15086FLG	
29540494	Blue Bird	All-American with Caterpillar 3126 Engine	PT9415MPGK1TJAB		
29540494	Blue Bird	All-American, Vision with Caterpillar C7 Engine	PT9415MPGK1TJAB		
29540494	Blue Bird	All-American, TC 2000, Vision with Cummins ISB 5.9L Engine	PT9415MPGK1TJAB		
29540494	Blue Bird	All-American, Vision with Cummins ISC Engine	PT9415MPGK1TJAB		
29540494	Blue Bird	All-American with John Deere 6081 Engine	PT9415MPGK1TJAB		

OEM Part Number	Manufacturer	Engine Make/Model	Baldwin	Fleetguard	Donaldson
29540494	Blue Bird	Vision with Caterpillar 3126E Engine	PT9415MPGK1TJAB		
29540494	Blue Bird	Vision with GMC 8.1L Engine	PT9415MPGK1TJAB		

TRANSMISSION FILTER - FOR 5R110W, MADE BEFORE NOVEMBER 2007

FT144	Blue Bird	Micro Bird with Ford 6.0L Turbo Diesel Engine	20005JAB		
FT144	Blue Bird	Micro Bird with Ford 6.8L Gas Engine	20005JAB		

TRANSMISSION FILTER - FOR 5R110W, MADE FROM NOVEMBER 2007 TO PRESENT

FT180	Blue Bird	Micro Bird with Ford 6.0L Turbo Diesel Engine	20021JAB		
FT180	Blue Bird	Micro Bird with Ford 6.8L Gas Engine	20021JAB		

TRANSMISSION FILTER - FOR AODE

FT158	Blue Bird	Micro Bird with Ford 6.0L Turbo Diesel Engine	18029JAB		
FT158	Blue Bird	Micro Bird with Ford 6.8L Gas Engine	18029JAB		

TRANSMISSION FILTER ELEMENT - 2" KIT

29540493	Blue Bird	Vision with GMC 8.1L Natural Gas Engine	PT9416MPGK1TJAB		
----------	-----------	---	-----------------	--	--

TRANSMISSION FILTER ELEMENT - 2" KIT, 3000 & 4000 SERIES

29540493	Blue Bird	All-American with John Deere 6081 8.1L Clear Natural Gas Engine	PT9416MPGK1TJAB		
29540493	Blue Bird	All-American with Caterpillar 3126 Engine	PT9416MPGK1TJAB		

TRANSMISSION FILTER ELEMENT - 4" KIT

29540494	Blue Bird	Vision with Caterpillar C7 Engine	PT9415MPGK1TJAB		
29540494	Blue Bird	Vision with Caterpillar 3126E Engine	PT9415MPGK1TJAB		
29540494	Blue Bird	Vision with GMC 8.1L Natural Gas Engine	PT9415MPGK1TJAB		

TRANSMISSION FILTER ELEMENT - 4" KIT, 3000 & 4000 SERIES

29540494	Blue Bird	All-American with Caterpillar C7 Engine	PT9415MPGK1TJAB		
29540494	Blue Bird	All-American with Caterpillar 3126 Engine	PT9415MPGK1TJAB		
29540494	Blue Bird	All-American, Vision with Cummins ISB 5.9L Engine	PT9415MPGK1TJAB		
29540494	Blue Bird	All-American, Vision with Cummins ISC Engine	PT9415MPGK1TJAB		
29540494	Blue Bird	All-American with John Deere 6081 8.1L Clear Natural Gas Engine	PT9415MPGK1TJAB		

TRANSMISSION FILTER KIT

F4TZ7A098A	Blue Bird	Micro Bird with Ford 6.8L Engine		TF15027FLG	
F6AZ7A098A	Blue Bird	Micro Bird with Ford 6.0L Engine		TF15027FLG	

TRANSMISSION FILTER PAN-TYPE - 3.8" PAN

29540976	Blue Bird	TC 2000 with Caterpillar 3116 Engine	PT9415MPGK1TJAB		
29540976	Blue Bird	TC 2000 with Cummins 6BT 5.9L Diesel Engine	PT9415MPGK1TJAB		

TRANSMISSION FILTER PAN-TYPE - 3.8" PAN, AT SERIES

29540976	Blue Bird	All-American with Caterpillar C7 Engine	PT9415MPGK1TJAB		
29540976	Blue Bird	All-American with John Deere 6081 8.1L Clear Natural Gas Engine	PT9415MPGK1TJAB		

OEM Part Number	Manufacturer	Engine Make/Model	Baldwin	Fleetguard	Donaldson
-----------------	--------------	-------------------	---------	------------	-----------

TRANSMISSION FILTER PAN-TYPE - 5.3" PAN

29538489	Blue Bird	TC 2000 with Caterpillar 3116 Engine	19739JAB		
29538489	Blue Bird	TC 2000 with Cummins 6BT 5.9L Diesel Engine	19739JAB		

TRANSMISSION FILTER PAN-TYPE - 5.3" PAN, AT & MT SERIES

29538489	Blue Bird	All-American with John Deere 6081 8.1L Clear Natural Gas Engine	19739JAB		
----------	-----------	---	----------	--	--

TRANSMISSION FILTER PAN-TYPE - DEEP PAN WITH GASKET

29537966	Blue Bird	Micro Bird with GMC 4.8L Gas Engine	20003JAB		
29537966	Blue Bird	Micro Bird with GMC 6.0L Gas Engine	20003JAB		
29537966	Blue Bird	Micro Bird with GMC 6.6L Turbo Diesel Engine	20003JAB		
29537966	Blue Bird	Vision with Caterpillar 3126E Engine	20003JAB		
29537966	Blue Bird	Vision with GMC 8.1L Natural Gas Engine	20003JAB		

TRANSMISSION FILTER PAN-TYPE - DEEP PAN WITH GASKET, 2000 SERIES

29537966	Blue Bird	All-American, Vision with Caterpillar C7 Engine	20003JAB		
29537966	Blue Bird	All-American with Caterpillar 3126 Engine	20003JAB		
29537966	Blue Bird	All-American, Vision with Cummins ISB 5.9L Engine	20003JAB		
29537966	Blue Bird	All-American, Vision with Cummins ISC Engine	20003JAB		
29537966	Blue Bird	All-American with John Deere 6081 8.1L Clear Natural Gas Engine	20003JAB		

TRANSMISSION FILTER PAN-TYPE - DEEP PAN WITHOUT GASKET

29537966	Blue Bird	Micro Bird with GMC 4.8L Gas Engine	20017JAB		
29537966	Blue Bird	Micro Bird with GMC 6.0L Gas Engine	20017JAB		
29537966	Blue Bird	Micro Bird with GMC 6.6L Turbo Diesel Engine	20017JAB		
29537966	Blue Bird	Vision with Caterpillar C7 Engine	20017JAB		
29537966	Blue Bird	Vision with Caterpillar 3126E Engine	20017JAB		
29537966	Blue Bird	Vision with GMC 8.1L Natural Gas Engine	20017JAB		

TRANSMISSION FILTER PAN-TYPE - DEEP PAN WITHOUT GASKET, 2000 SERIES

29537966	Blue Bird	All-American with Caterpillar 3126 Engine	20017JAB		
29537966	Blue Bird	All-American, Vision with Cummins ISB 5.9L Engine	20017JAB		
29537966	Blue Bird	All-American, Vision with Cummins ISC Engine	20017JAB		
29537966	Blue Bird	All-American with John Deere 6081 8.1L Clear Natural Gas Engine	20017JAB		

TRANSMISSION FILTER PAN-TYPE - SHALLOW PAN WITH GASKET

29537965	Blue Bird	Micro Bird with GMC 4.8L Gas Engine	20016JAB		
29537965	Blue Bird	Micro Bird with GMC 6.0L Gas Engine	20016JAB		
29537965	Blue Bird	Micro Bird with GMC 6.6L Turbo Diesel Engine	20016JAB		
29537965	Blue Bird	Vision with Caterpillar 3126E Engine	20016JAB		
29537965	Blue Bird	Vision with Cummins ISB Engine	20016JAB		
29537965	Blue Bird	Vision with GMC 8.1L Natural Gas Engine	20016JAB		

OEM Part Number	Manufacturer	Engine Make/Model	Baldwin	Fleetguard	Donaldson
-----------------	--------------	-------------------	---------	------------	-----------

TRANSMISSION FILTER PAN-TYPE - SHALLOW PAN WITH GASKET, 2000 SERIES

29537965	Blue Bird	All-American, Vision with Caterpillar C7 Engine	20016JAB		
29537965	Blue Bird	All-American with Caterpillar 3126 Engine	20016JAB		
29537965	Blue Bird	All-American with Cummins ISB 5.9L Engine	20016JAB		
29537965	Blue Bird	All-American, Vision with Cummins ISC Engine	20016JAB		
29537965	Blue Bird	All-American with John Deere 6081 8.1L Clear Natural Gas Engine	20016JAB		

TRANSMISSION FILTER PAN-TYPE - SHALLOW PAN WITHOUT GASKET

29537965	Blue Bird	Micro Bird with GMC 4.8L Gas Engine	20004JAB		
29537965	Blue Bird	Micro Bird with GMC 6.0L Gas Engine	20004JAB		
29537965	Blue Bird	Micro Bird with GMC 6.6L Turbo Diesel Engine	20004JAB		
29537965	Blue Bird	Vision with Caterpillar 3126E Engine	20004JAB		
29537965	Blue Bird	Vision with Cummins ISB Engine	20004JAB		
29537965	Blue Bird	Vision with GMC 8.1L Natural Gas Engine	20004JAB		

TRANSMISSION FILTER PAN-TYPE - SHALLOW PAN WITHOUT GASKET, 2000 SERIES

29537965	Blue Bird	All-American, Vision with Caterpillar C7 Engine	20004JAB		
29537965	Blue Bird	All-American with Caterpillar 3126 Engine	20004JAB		
29537965	Blue Bird	All-American with Cummins ISB 5.9L Engine	20004JAB		
29537965	Blue Bird	All-American, Vision with Cummins ISC Engine	20004JAB		
29537965	Blue Bird	All-American with John Deere 6081 8.1L Clear Natural Gas Engine	20004JAB		

TRANSMISSION FILTER, SPIN-ON

29510922	Blue Bird	TC 2000 with Caterpillar 3116 Engine	BT8316MPGJAB		
29510922	Blue Bird	TC 2000 with Cummins 6BT 5.9L Diesel Engine	BT8316MPGJAB		
29539579	Blue Bird	Micro Bird with GMC 4.8L Gas Engine	BT8460JAB		
29539579	Blue Bird	Micro Bird with GMC 6.0L Gas Engine	BT8460JAB		
29539579	Blue Bird	Micro Bird with GMC 6.6L Turbo Diesel Engine	BT8460JAB		
29539579	Blue Bird	Vision with Caterpillar 3126E Engine	BT8460JAB		
29539579	Blue Bird	Vision with GMC 8.1L Natural Gas Engine	BT8460JAB		

TRANSMISSION FILTER, SPIN-ON - 2000 SERIES

29539579	Blue Bird	All-American with John Deere 6081 8.1L Clear Natural Gas Engine	BT8460JAB		
----------	-----------	---	-----------	--	--

TRANSMISSION FILTER, SPIN-ON - AT & MT SERIES

29510922	Blue Bird	All-American with Caterpillar C7 Engine	BT8316MPGJAB		
29510922	Blue Bird	All-American with Caterpillar 3126 Engine	BT8316MPGJAB		
29510922	Blue Bird	All-American with John Deere 6081 8.1L Clear Natural Gas Engine	BT8316MPGJAB		

TRANSMISSION FILTER, SPIN-ON - AT & MT SERIES, AUXILIARY

29510922	Blue Bird	All-American, TC 2000 with Cummins ISB 5.9L Engine	BT8316MPGJAB		
29510922	Blue Bird	All-American with Cummins ISC Engine	BT8316MPGJAB		

COLLINS**COLLINS AIR FILTERS**

Table 12-7: Air Filters for Collins

OEM Part Number	Manufacturer	Engine Make/Model	Baldwin	Fleetguard	Donaldson
-----------------	--------------	-------------------	---------	------------	-----------

AIR FILTER

FA1746	Collins	Bantam, Mid Bus with Ford 6.0L Diesel Engine	CA4999JAB		
FA1632	Collins	Mid Bus with Ford 5.4L Gas Engine	PA4075JAB		
FA1634	Collins	Bantam with Ford 5.4L Gas Engine	PA4075JAB		

RADIAL SEAL AIR FILTER

A1621C	Collins	Bantam, Mid Bus with GM 4.8L Gas Engine	RS4131JAB		
A1621C	Collins	Bantam, Mid Bus with GM 6.0L Gas Engine	RS4131JAB		
A2032C	Collins	Bantam, Mid Bus with GM 6.6L Diesel Engine	RS4859JAB		

COLLINS FUEL FILTERS

Table 12-8: Fuel Filters for Collins

OEM Part Number	Manufacturer	Engine Make/Model	Baldwin	Fleetguard	Donaldson
-----------------	--------------	-------------------	---------	------------	-----------

FUEL FILTER

FG986B	Collins	Bantam, Mid Bus with Ford 5.4L Gas Engine	BF7668JAB		
FD4606	Collins	Bantam, Mid Bus with Ford 6.0L Diesel Engine	PF7852K1TJAB		

FUEL FILTER - MADE FROM 2003 TO 2005, THREAD BOTH ENDS

GF652	Collins	Bantam with GM 6.0L Gas Engine	BF1123JAB		
GF652	Collins	Mid Bus with GM 4.8L Gas Engine	BF1393JAB		
GF652	Collins	Mid Bus with GM 6.0L Gas Engine	BF1663JAB		
GF652	Collins	Bantam with GM 4.8L Gas Engine	BF853JAB		

FUEL FILTER - MADE FROM 2003 TO 2005, THREAD ONE END

GF578	Collins	Bantam, Mid Bus with GM 4.8L Gas Engine	BF1171JAB		
GF578	Collins	Bantam, Mid Bus with GM 6.0L Gas Engine	BF1171JAB		

COLLINS FUEL/WATER SEPARATOR FILTERS

Table 12-9: Fuel/Water Separator Filters for Collins

OEM Part Number	Manufacturer	Engine Make/Model	Baldwin	Fleetguard	Donaldson
FUEL/WATER SEPARATOR FILTER					
TP1298B	Collins	Bantam, Mid Bus with GM 6.6L Diesel Engine	BF7827JAB		

COLLINS LUBE/OIL FILTERS

Table 12-10: Lube/Oil Filters for Collins

OEM Part Number	Manufacturer	Engine Make/Model	Baldwin	Fleetguard	Donaldson
LUBE FILTER					
PF2232	Collins	Bantam, Mid Bus with GM 6.6L Diesel Engine	B1441JAB		
FL820S	Collins	Bantam, Mid Bus with Ford 5.4L Gas Engine	B329JAB		
LUBE FILTER - MADE FROM 2003 TO 2005					
PF46	Collins	Bantam, Mid Bus with GM 4.8L Gas Engine	B31JAB		
LUBE FILTER - MADE FROM 2003 TO 2006					
PF46	Collins	Bantam, Mid Bus with GM 6.0L Gas Engine	B31JAB		
LUBE FILTER - MADE FROM 2006 TO PRESENT					
n/a	Collins	Bantam, Mid Bus with GM 4.8L Gas Engine	B160JAB		
LUBE FILTER - MADE FROM 2007 TO PRESENT					
n/a	Collins	Bantam, Mid Bus with GM 6.0L Gas Engine	B160JAB		
LUBE FILTER - WITHOUT SCREW-ON CAP					
FL2016	Collins	Bantam, Mid Bus with Ford 6.0L Diesel Engine	P7235JAB		

COLLINS STEERING FILTERS

Table 12-11: Steering Filters for Collins

OEM Part Number	Manufacturer	Engine Make/Model	Baldwin	Fleetguard	Donaldson
STEERING FILTER					
88892858	Collins	Bantam with GM 6.6L Diesel Engine	P106HDJAB		

COLLINS TRANSMISSION FILTERS

Table 12-12: Transmission Filters for Collins

OEM Part Number	Manufacturer	Engine Make/Model	Baldwin	Fleetguard	Donaldson
TRANSMISSION FILTER - DEEP PAN WITH GASKET					
29537966	Collins	Bantam, Mid Bus with GM 6.6L Diesel Engine	20003JAB		
TRANSMISSION FILTER - DEEP PAN WITHOUT GASKET					
29537966	Collins	Bantam, Mid Bus with GM 6.6L Diesel Engine	20017JAB		
TRANSMISSION FILTER - DEEP PAN, FOR 4L60E					
24208576	Collins	Bantam, Mid Bus with GM 4.8L Gas Engine	18056JAB		
24208576	Collins	Bantam, Mid Bus with GM 6.0L Gas Engine	18056JAB		
FT114	Collins	Bantam with Ford 5.4L Gas Engine	18265JAB		
TRANSMISSION FILTER - SHALLOW PAN WITH GASKET					
29537965	Collins	Bantam, Mid Bus with GM 6.6L Diesel Engine	20016JAB		
TRANSMISSION FILTER - SHALLOW PAN WITHOUT GASKET					
29537965	Collins	Bantam, Mid Bus with GM 6.6L Diesel Engine	20004JAB		
TRANSMISSION FILTER - SHALLOW PAN, FOR 4L60E					
24200796	Collins	Bantam, Mid Bus with GM 4.8L Gas Engine	18010JAB		
24200796	Collins	Bantam, Mid Bus with GM 6.0L Gas Engine	18010JAB		
TRANSMISSION FILTER - SHALLOW PAN, FOR 4R100					
FT113	Collins	Bantam, Mid Bus with Ford 5.4L Gas Engine	18264JAB		
TRANSMISSION FILTER - FOR 4L80E					
24210956	Collins	Bantam, Mid Bus with GM 4.8L Gas Engine	18027JAB		
24210956	Collins	Bantam, Mid Bus with GM 6.0L Gas Engine	18027JAB		
TRANSMISSION FILTER - FOR 4R70W					
FT105	Collins	Bantam, Mid Bus with Ford 5.4L Gas Engine	18029JAB		

OEM Part Number	Manufacturer	Engine Make/Model	Baldwin	Fleetguard	Donaldson
-----------------	--------------	-------------------	---------	------------	-----------

TRANSMISSION FILTER - FOR 5R110W, MADE FROM NOVEMBER 2007 TO PRESENT

FT180	Collins	Bantam, Mid Bus with Ford 5.4L Gas Engine	20021JAB		
FT180	Collins	Bantam, Mid Bus with Ford 6.0L Diesel Engine	20021JAB		

TRANSMISSION FILTER ELEMENT

FT145	Collins	Bantam, Mid Bus with Ford 6.0L Diesel Engine	P7247JAB		
-------	---------	--	----------	--	--

TRANSMISSION FILTER ELEMENT - FOR 5R110W

FT145	Collins	Bantam, Mid Bus with Ford 5.4L Gas Engine	P7247JAB		
-------	---------	---	----------	--	--

TRANSMISSION FILTER PAN-TYPE - FOR 5R110W, MADE BEFORE NOVEMBER 2007

FT144	Collins	Bantam, Mid Bus with Ford 5.4L Gas Engine	20005JAB		
FT144	Collins	Bantam, Mid Bus with Ford 6.0L Diesel Engine	20005JAB		

TRANSMISSION FILTER PAN-TYPE - MADE BEFORE NOVEMBER 2007

FT144	Collins	Mid Bus with Ford 6.0L Diesel Engine	20005JAB		
-------	---------	--------------------------------------	----------	--	--

TRANSMISSION FILTER, SPIN-ON

29539579	Collins	Bantam, Mid Bus with GM 6.6L Diesel Engine	BT8460JAB		
----------	---------	--	-----------	--	--

CORBEIL**CORBEIL AIR FILTERS**

Table 12-13: Air Filters for Corbeil

OEM Part Number	Manufacturer	Engine Make/Model	Baldwin	Fleetguard	Donaldson
-----------------	--------------	-------------------	---------	------------	-----------

AIR FILTER

FA1634	Corbeil	Quantum with Ford 5.4L Gas Engine	PA4075JAB		
--------	---------	-----------------------------------	-----------	--	--

CHANNEL FLOW AIR FILTER

FA1746	Corbeil	Quantum with Ford 6.0L Diesel Engine	CA4999JAB		
--------	---------	--------------------------------------	-----------	--	--

RADIAL SEAL AIR FILTER

A1621C	Corbeil	Quantum with GM 4.8L Gas Engine	RS4131JAB		
A1621C	Corbeil	Quantum with GM 6.0L Gas Engine	RS4131JAB		
A2032C	Corbeil	Quantum with GM 6.6L Diesel Engine	RS4859JAB		

CORBEIL FUEL FILTERS

Table 12-14: Fuel Filters for Corbeil

OEM Part Number	Manufacturer	Engine Make/Model	Baldwin	Fleetguard	Donaldson
-----------------	--------------	-------------------	---------	------------	-----------

FUEL FILTER

FG986B	Corbeil	Quantum with Ford 5.4L Gas Engine	BF7668JAB		
FD4606	Corbeil	Quantum with Ford 6.0L Diesel Engine	PF7852K1TJAB		

FUEL FILTER - MADE FROM 2003 TO 2005, THREAD BOTH ENDS

GF652	Corbeil	Quantum with GM 4.8L Gas Engine	BF1933JAB		
GF652	Corbeil	Quantum with GM 6.0L Gas Engine	BF2203JAB		

FUEL FILTER - MADE FROM 2003 TO 2005, THREAD ONE END

GF578	Corbeil	Quantum with GM 4.8L Gas Engine	BF1171JAB		
GF578	Corbeil	Quantum with GM 6.0L Gas Engine	BF1171JAB		

CORBEIL FUEL/WATER SEPARATOR FILTERS

Table 12-15: Fuel/Water Separator Filters for Corbeil

OEM Part Number	Manufacturer	Engine Make/Model	Baldwin	Fleetguard	Donaldson
FUEL/WATER SEPARATOR FILTER					
TP1298B	Corbeil	Quantum with GM 6.6L Diesel Engine	BF7827JAB		

CORBEIL LUBE/OIL FILTERS

Table 12-16: Lube/Oil Filters for Corbeil

OEM Part Number	Manufacturer	Engine Make/Model	Baldwin	Fleetguard	Donaldson
LUBE FILTER					
PF2232	Corbeil	Quantum with GM 6.6L Diesel Engine	B1441JAB		
FL820S	Corbeil	Quantum with Ford 5.4L Gas Engine	B329JAB		
LUBE FILTER - MADE FROM 2003 TO 2005					
PF46	Corbeil	Quantum with GM 4.8L Gas Engine	B31JAB		
LUBE FILTER - MADE FROM 2003 TO 2006					
PF46	Corbeil	Quantum with GM 6.0L Gas Engine	B31JAB		
LUBE FILTER - MADE FROM 2006 TO PRESENT					
n/a	Corbeil	Quantum with GM 4.8L Gas Engine	B160JAB		
LUBE FILTER - MADE FROM 2007 TO PRESENT					
n/a	Corbeil	Quantum with GM 6.0L Gas Engine	B160JAB		
LUBE FILTER - WITHOUT SCREW-ON CAP					
FL2016	Corbeil	Quantum with Ford 6.0L Diesel Engine	P7235JAB		

CORBEIL STEERING FILTERS

Table 12-17: Steering Filters for Corbeil

OEM Part Number	Manufacturer	Engine Make/Model	Baldwin	Fleetguard	Donaldson
STEERING FILTER					
88892858	Corbeil	Quantum with GM 6.6L Diesel Engine	P106HDJAB		

CORBEIL TRANSMISSION FILTERS

Table 12-18: Transmission Filters for Corbeil

OEM Part Number	Manufacturer	Engine Make/Model	Baldwin	Fleetguard	Donaldson
TRANSMISSION FILTER - DEEP PAN, FOR 4L60E					
24208576	Corbeil	Quantum with GM 4.8L Gas Engine	18056JAB		
24208576	Corbeil	Quantum with GM 6.0L Gas Engine	18056JAB		
TRANSMISSION FILTER - DEEP PAN, FOR 4R100					
FT114	Corbeil	Quantum with Ford 5.4L Gas Engine	18265JAB		
TRANSMISSION FILTER - SHALLOW PAN, FOR 4L60E					
24200796	Corbeil	Quantum with GM 4.8L Gas Engine	18010JAB		
24200796	Corbeil	Quantum with GM 6.0L Gas Engine	18010JAB		
TRANSMISSION FILTER - SHALLOW PAN, FOR 4R100					
FT113	Corbeil	Quantum with Ford 5.4L Gas Engine	18264JAB		
TRANSMISSION FILTER - FOR 4L80E					
24210956	Corbeil	Quantum with GM 4.8L Gas Engine	18027JAB		
24210956	Corbeil	Quantum with GM 6.0L Gas Engine	18027JAB		
TRANSMISSION FILTER - FOR 4R70W					
FT105	Corbeil	Quantum with Ford 5.4L Gas Engine	18029JAB		
TRANSMISSION FILTER - FOR 5R110W, MADE BEFORE NOVEMBER 2007					
FT144	Corbeil	Quantum with Ford 5.4L Gas Engine	20005JAB		
TRANSMISSION FILTER - FOR 5R110W, MADE FROM NOVEMBER 2007 TO PRESENT					
FT180	Corbeil	Quantum with Ford 5.4L Gas Engine	20021JAB		
TRANSMISSION FILTER ELEMENT					
FT145	Corbeil	Quantum with Ford 6.0L Diesel Engine	P7247JAB		
TRANSMISSION FILTER ELEMENT - FOR 5R110W					
FT145	Corbeil	Quantum with Ford 5.4L Gas Engine	P7247JAB		

OEM Part Number	Manufacturer	Engine Make/Model	Baldwin	Fleetguard	Donaldson
-----------------	--------------	-------------------	---------	------------	-----------

TRANSMISSION FILTER PAN-TYPE - DEEP PAN WITH GASKET

29537966	Corbeil	Quantum with GM 6.6L Diesel Engine	20003JAB		
----------	---------	------------------------------------	----------	--	--

TRANSMISSION FILTER PAN-TYPE - DEEP PAN WITHOUT GASKET

29537966	Corbeil	Quantum with GM 6.6L Diesel Engine	20017JAB		
----------	---------	------------------------------------	----------	--	--

TRANSMISSION FILTER PAN-TYPE - SHALLOW PAN WITH GASKET

29537965	Corbeil	Quantum with GM 6.6L Diesel Engine	20016JAB		
----------	---------	------------------------------------	----------	--	--

TRANSMISSION FILTER PAN-TYPE - SHALLOW PAN WITHOUT GASKET

29537965	Corbeil	Quantum with GM 6.6L Diesel Engine	20004JAB		
----------	---------	------------------------------------	----------	--	--

TRANSMISSION FILTER PAN-TYPE - MADE BEFORE NOVEMBER 2007

FT144	Corbeil	Quantum with Ford 6.0L Diesel Engine	20005JAB		
-------	---------	--------------------------------------	----------	--	--

TRANSMISSION FILTER PAN-TYPE - MADE FROM NOVEMBER 2007 TO PRESENT

FT180	Corbeil	Quantum with Ford 6.0L Diesel Engine	20021JAB		
-------	---------	--------------------------------------	----------	--	--

TRANSMISSION FILTER, SPIN-ON

29539579	Corbeil	Quantum with GM 6.6L Diesel Engine	BT8460JAB		
----------	---------	------------------------------------	-----------	--	--

FORD

FORD AIR FILTERS

Table 12-19: Air Filters for Ford

OEM Part Number	Manufacturer	Engine Make/Model	Baldwin	Fleetguard	Donaldson
-----------------	--------------	-------------------	---------	------------	-----------

PRIMARY AIR - RADIAL SEAL FILTER

BF6X9601A	Ford	Series 14			P618941
-----------	------	-----------	--	--	---------

FORD LUBE/OIL FILTERS

Table 12-20: Lube/Oil Filters for Ford

OEM Part Number	Manufacturer	Engine Make/Model	Baldwin	Fleetguard	Donaldson
-----------------	--------------	-------------------	---------	------------	-----------

LUBE FILTER

n/a	Ford	E350 V8-330 (5.4L) Fuel Injection or Flex Fuel	B329JAB BF7668JAB PA4075JAB		
n/a	Ford	E350 V10-415 (6.8L) Fuel Injection	B329JAB BF7668JAB PA4075JAB		

LUBE FILTER - WITHOUT SCREW-ON CAP

n/a	Ford	E350 V8-366 6.0L Dual Injection Turbo Diesel	P7235JAB PF7852K1TJAB PA4171JAB		
-----	------	--	---------------------------------------	--	--

FORD TRANSMISSION FILTERS

Table 12-21: Transmission Filters for Ford

OEM Part Number	Manufacturer	Engine Make/Model	Baldwin	Fleetguard	Donaldson
TRANSMISSION FILTER					
4R75-W	Ford	E350 V8-330 (5.4L) Fuel Injection or Flex Fuel	18029JAB		
4R75-W	Ford	E350 V8-366 6.0L Dual Injection Turbo Diesel	18029JAB		
6R80	Ford	E350 V8-330 (5.4L) Fuel Injection or Flex Fuel	20019JAB		
6R80	Ford	E350 V8-366 6.0L Dual Injection Turbo Diesel	20019JAB		
6R80	Ford	E350 V10-415 (6.8L) Fuel Injection	20019JAB		

FREIGHTLINER

FREIGHTLINER AIR FILTERS

Table 12-22: Air Filters for Freightliner

OEM Part Number	Manufacturer	Engine Make/Model	Baldwin	Fleetguard	Donaldson
AIR FILTER					
FA1632	Freightliner	MB-IV/G5 with Ford 6.8L Gas Engine	PA4075JAB		
FA1634	Freightliner	MB-II, MB-IV/G5 with Ford 5.4L Gas Engine	PA4075JAB		
CHANNEL FLOW AIR FILTER					
P607955	Freightliner	B2 Bus Chassis, C2 School Bus with Caterpillar C7 Engine	CA4700JAB		
P607955	Freightliner	B2 Bus Chassis, C2 School Bus with Cummins ISB Engine	CA4700JAB		
FA1746	Freightliner	MB-II, MB-IV/G5 with Ford 6.0L Diesel Engine	CA4999JAB		
CHANNEL FLOW AIR FILTER - WITH FLAME RETARDANT MEDIA					
P607960	Freightliner	B2 Bus Chassis, C2 School Bus with Caterpillar C7 Engine	CA5420JAB		
P607960	Freightliner	B2 Bus Chassis, C2 School Bus with Cummins ISB Engine	CA5420JAB		
CHANNEL FLOW SAFETY AIR FILTER					
P544432	Freightliner	B2 Bus Chassis, C2 School Bus with Caterpillar C7 Engine	PA4701JAB		
P544432	Freightliner	B2 Bus Chassis, C2 School Bus with Cummins ISB Engine	PA4701JAB		
DISPOSABLE AIR FILTER HOUSING					
61100179	Freightliner	C2 School Bus with Caterpillar C7 Engine	PA3891JAB		
61100179	Freightliner	C2 School Bus with Cummins ISB Engine	PA3891JAB		
114880005	Freightliner	FS-65 Bus with Cummins ISB 5.9L Engine	PA4655JAB		
RADIAL SEAL AIR FILTER					
A1621C	Freightliner	MB-II with GM 4.8L Gas Engine	RS4131JAB		
A1621C	Freightliner	MB-II, MB-IV/G5 with GM 6.0L Gas Engine	RS4131JAB		
A2032C	Freightliner	MB-II, MB-IV/G5 with GM 6.6L Diesel Engine	RS4859JAB		
RADIAL SEAL INNER AIR FILTER					
P532504	Freightliner	FS-65 Bus with Caterpillar 3126 Engine	RS3507JAB		
P532504	Freightliner	FS-65 Bus with Caterpillar C7 Engine	RS3507JAB		
P532504	Freightliner	FS-65 Bus with Cummins ISB 5.9L Engine	RS3507JAB		
RADIAL SEAL OUTER AIR FILTER					
P532503	Freightliner	FS-65 Bus with Caterpillar 3126 Engine	RS3506JAB		
P532503	Freightliner	FS-65 Bus with Caterpillar C7 Engine	RS3506JAB		
P532503	Freightliner	FS-65 Bus with Cummins ISB 5.9L Engine	RS3506JAB		

OEM Part Number	Manufacturer	Engine Make/Model	Baldwin	Fleetguard	Donaldson
-----------------	--------------	-------------------	---------	------------	-----------

SINGLE RADIAL SEAL AIR FILTER

P532966	Freightliner	FS-65 Bus with Caterpillar 3126 Engine	RS3517JAB		
P532966	Freightliner	FS-65 Bus with Caterpillar C7 Engine	RS3517JAB		
P532966	Freightliner	FS-65 Bus with Cummins ISB 5.9L Engine	RS3517JAB		

FREIGHTLINER FUEL FILTERS

Table 12-23: Fuel Filters for Freightliner

OEM Part Number	Manufacturer	Engine Make/Model	Baldwin	Fleetguard	Donaldson
-----------------	--------------	-------------------	---------	------------	-----------

FUEL FILTER

1R0751	Freightliner	B2 Bus Chassis, C2 School Bus, FS-65 Bus with Caterpillar C7 Engine	BF7632JAB		
1R0751	Freightliner	FS-65 Bus with Caterpillar 3126 Engine	BF7632JAB		
FG986B	Freightliner	MB-II, MB-IV/G5 with Ford 5.4L Gas Engine	BF7668JAB		
FF5632	Freightliner	B2 Bus Chassis with Cummins ISB Engine	BF7940JAB		
FD4606	Freightliner	MB-II, MB-IV/G5 with Ford 6.0L Diesel Engine	PF7852K1T-JAB		

FUEL FILTER - MADE BEFORE 2002

FG872	Freightliner	MB-IV/G5 with Ford 6.8L Gas Engine	BF1166JAB		
-------	--------------	------------------------------------	-----------	--	--

FUEL FILTER - MADE FROM 2003 TO 2005, THREAD BOTH ENDS

GF652	Freightliner	MB-II with GM 4.8L Gas Engine	BF2473JAB		
GF652	Freightliner	MB-II with GM 6.0L Gas Engine	BF2743JAB		
GF652	Freightliner	MB-IV/G5 with GM 6.0L Gas Engine	BF3013JAB		

FUEL FILTER - MADE FROM 2003 TO 2005, THREAD ONE END

GF578	Freightliner	MB-II with GM 4.8L Gas Engine	BF1171JAB		
GF578	Freightliner	MB-II, MB-IV/G5 with GM 6.0L Gas Engine	BF1171JAB		

FUEL FILTER - MADE FROM 2003 TO PRESENT

FG986B	Freightliner	MB-IV/G5 with Ford 6.8L Gas Engine	BF7668JAB		
--------	--------------	------------------------------------	-----------	--	--

FREIGHTLINER FUEL/WATER SEPARATOR FILTERS

Table 12-24: Fuel/Water Separator Filters for Freightliner

OEM Part Number	Manufacturer	Engine Make/Model	Baldwin	Fleetguard	Donaldson
-----------------	--------------	-------------------	---------	------------	-----------

FUEL/WATER SEPARATOR FILTER

3942470	Freightliner	FS-65 Bus with Cummins ISB 5.9L Engine	PF7777JAB		
R50418	Freightliner	B2 Bus Chassis with Caterpillar C7 Engine	BF1339SPJAB		
ABPS3226FL01	Freightliner	B2 Bus Chassis, C2 School Bus with Caterpillar C7 Engine	BF1373SPJAB		
R50419	Freightliner	B2 Bus Chassis with Cummins ISB Engine	BF1373SPJAB		
198-6378	Freightliner	FS-65 Bus with Caterpillar C7 Engine	BF7798SPJAB		
TP1298B	Freightliner	MB-II, MB-IV/G5 with GM 6.6L Diesel Engine	BF7827JAB		
FS19729	Freightliner	C2 School Bus with Caterpillar C7 Engine	PF7755JAB		

FUEL/WATER SEPARATOR FILTER - OPEN END

R50418	Freightliner	B2 Bus Chassis with Caterpillar C7 Engine	BF13290JAB		
--------	--------------	---	------------	--	--

FUEL/WATER SEPARATOR FILTER - OPEN END, SPIN-ON

R50418	Freightliner	C2 School Bus with Caterpillar C7 Engine	BF13290JAB		
--------	--------------	--	------------	--	--

FUEL/WATER SEPARATOR FILTER - WITH SENSOR PORT

S3225P	Freightliner	FS-65 Bus with Caterpillar 3126 Engine	BF1348SPJAB		
S3225P	Freightliner	FS-65 Bus with Caterpillar C7 Engine	BF1348SPJAB BF1346SPJAB		

FUEL/WATER SEPARATOR FILTER - WITH SENSOR PORT, SPIN-ON

S3225P	Freightliner	FS-65 Bus with Cummins ISB 5.9L Engine	BF1348SPJAB		
--------	--------------	--	-------------	--	--

FUEL/WATER SEPARATOR FILTER - WITHOUT SENSOR PORT

S3225P	Freightliner	FS-65 Bus with Caterpillar 3126 Engine	BF1348JAB		
S3225P	Freightliner	FS-65 Bus with Caterpillar C7 Engine	BF1348JAB BF1346JAB		

FUEL/WATER SEPARATOR FILTER - WITHOUT SENSOR PORT, SPIN-ON

S3225P	Freightliner	FS-65 Bus with Cummins ISB 5.9L Engine	BF1348JAB		
--------	--------------	--	-----------	--	--

FUEL/WATER SEPARATOR FILTER, SPIN-ON

R50418	Freightliner	C2 School Bus with Caterpillar C7 Engine	BF1339SPJAB		
--------	--------------	--	-------------	--	--

OPTIONAL FUEL/WATER SEPARATOR FILTER

S3226T	Freightliner	C2 School Bus with Cummins ISB Engine	BF1347JAB		
--------	--------------	---------------------------------------	-----------	--	--

FREIGHTLINER LUBE/OIL FILTERS

Table 12-25: Lube/Oil Filters for Freightliner

OEM Part Number	Manufacturer	Engine Make/Model	Baldwin	Fleetguard	Donaldson
FULL-FLOW LUBE FILTER					
3937144	Freightliner	FS-65 Bus with Cummins ISB 5.9L Engine	B7177JAB		
LUBE FILTER					
PF2232	Freightliner	MB-II, MB-IV/G5 with GM 6.6L Diesel Engine	B1441JAB		
FL820S	Freightliner	MB-II, MB-IV/G5 with Ford 5.4L Gas Engine	B329JAB		
FL820S	Freightliner	MB-IV/G5 with Ford 6.8L Gas Engine	B329JAB		
LF3970	Freightliner	B2 Bus Chassis, C2 School Bus with Cummins ISB Engine	B7177JAB		
1R1807	Freightliner	B2 Bus Chassis, C2 School Bus, FS-65 Bus with Caterpillar C7 Engine	B7700JAB		
LUBE FILTER - MADE BEFORE JANUARY 2004					
1R0739	Freightliner	C2 School Bus, FS-65 Bus with Caterpillar C7 Engine	B7600JAB		
1R0739	Freightliner	FS-65 Bus with Caterpillar 3126 Engine	B7600JAB		
LUBE FILTER - MADE FROM 2004 TO PRESENT					
1R1807	Freightliner	FS-65 Bus with Caterpillar 3126 Engine	B7700JAB		
LUBE FILTER - MADE FROM 2003 TO 2005					
PF46	Freightliner	MB-II with GM 4.8L Gas Engine	B31JAB		
LUBE FILTER - MADE FROM 2003 TO 2006					
PF46	Freightliner	MB-II, MB-IV/G5 with GM 6.0L Gas Engine	B31JAB		
LUBE FILTER - MADE FROM 2006 TO PRESENT					
n/a	Freightliner	MB-II with GM 4.8L Gas Engine	B160JAB		
LUBE FILTER - MADE FROM 2007 TO PRESENT					
n/a	Freightliner	MB-II, MB-IV/G5 with GM 6.0L Gas Engine	B160JAB		
LUBE FILTER - WITHOUT SCREW-ON CAP					
FL2016	Freightliner	MB-II, MB-IV/G5 with Ford 6.0L Diesel Engine	P7235JAB		

FREIGHTLINER STEERING FILTERS

Table 12-26: Steering Filters for Freightliner

OEM Part Number	Manufacturer	Engine Make/Model	Baldwin	Fleetguard	Donaldson
STEERING FILTER					
VMLT1808D	Freightliner	B2 Bus Chassis, C2 School Bus with Caterpillar C7 Engine	BT9388JAB		
VMLT1808D	Freightliner	B2 Bus Chassis, C2 School Bus with Cummins ISB Engine	BT9388JAB		
88892858	Freightliner	MB-II, MB-IV/G5 with GM 6.6L Diesel Engine	P106HDJAB		
VML/S1414	Freightliner	FS-65 Bus with Caterpillar 3126 Engine	PT8407JAB		
VML/S1414	Freightliner	FS-65 Bus with Caterpillar C7 Engine	PT8407JAB		
VML/S1414	Freightliner	FS-65 Bus with Cummins ISB 5.9L Engine	PT8407JAB		

FREIGHTLINER TRANSMISSION FILTERS

Table 12-27: Transmission Filters for Freightliner

OEM Part Number	Manufacturer	Engine Make/Model	Baldwin	Fleetguard	Donaldson
OPTIONAL TRANSMISSION FILTER, SPIN-ON					
17237	Freightliner	C2 School Bus with Caterpillar C7 Engine	B2JAB		
17237	Freightliner	C2 School Bus with Cummins ISB Engine	B2JAB		
TRANSMISSION FILTER - 2000 SERIES, SPIN-ON					
29537268	Freightliner	FS-65 Bus with Cummins ISB 5.9L Engine	BT8460JAB		
29539579	Freightliner	FS-65 Bus with Caterpillar 3126 Engine	BT8460JAB		
TRANSMISSION FILTER - AT SERIES, SPIN-ON					
29510922	Freightliner	FS-65 Bus with Caterpillar 3126 Engine	BT8316MPGJAB		
29510922	Freightliner	FS-65 Bus with Caterpillar C7 Engine	BT8316MPGJAB		
29510922	Freightliner	FS-65 Bus with Cummins ISB 5.9L Engine	BT8316MPGJAB		
TRANSMISSION FILTER - DEEP PAN, FOR 4L60E					
24208576	Freightliner	MB-II with GM 4.8L Gas Engine	18056JAB		
24208576	Freightliner	MB-II, MB-IV/G5 with GM 6.0L Gas Engine	18056JAB		
TRANSMISSION FILTER - DEEP PAN, FOR 4R100					
FT114	Freightliner	MB-II, MB-IV/G5 with Ford 5.4L Gas Engine	18265JAB		
TRANSMISSION FILTER - SHALLOW PAN, FOR 4L60E					
24200796	Freightliner	MB-II with GM 4.8L Gas Engine	18010JAB		
24200796	Freightliner	MB-II, MB-IV/G5 with GM 6.0L Gas Engine	18010JAB		
TRANSMISSION FILTER - SHALLOW PAN, FOR 4R100					
FT113	Freightliner	MB-II, MB-IV/G5 with Ford 5.4L Gas Engine	18264JAB		

OEM Part Number	Manufacturer	Engine Make/Model	Baldwin	Fleetguard	Donaldson
-----------------	--------------	-------------------	---------	------------	-----------

TRANSMISSION FILTER - FOR 4L80E

24210956	Freightliner	MB-II with GM 4.8L Gas Engine	18027JAB		
24210956	Freightliner	MB-II, MB-IV/G5 with GM 6.0L Gas Engine	18027JAB		

TRANSMISSION FILTER - FOR 4R100

FT105	Freightliner	MB-IV/G5 with Ford 6.8L Gas Engine	18029JAB		
-------	--------------	------------------------------------	----------	--	--

TRANSMISSION FILTER - FOR 4R70W

FT105	Freightliner	MB-II, MB-IV/G5 with Ford 5.4L Gas Engine	18029JAB		
-------	--------------	---	----------	--	--

TRANSMISSION FILTER - FOR 5R110W

FT144	Freightliner	MB-II, MB-IV/G5 with Ford 5.4L Gas Engine	20005JAB		
-------	--------------	---	----------	--	--

TRANSMISSION FILTER - FOR 5R110W, MADE FROM 2007 TO PRESENT

FT180	Freightliner	MB-IV/G5 with Ford 5.4L Gas Engine	20021JAB		
-------	--------------	------------------------------------	----------	--	--

TRANSMISSION FILTER - FOR E40D

FT113	Freightliner	MB-IV/G5 with Ford 6.8L Gas Engine	18264JAB		
-------	--------------	------------------------------------	----------	--	--

TRANSMISSION FILTER - OPTIONAL OIL COOLER

PF897	Freightliner	FS-65 Bus with Cummins ISB 5.9L Engine	BT230JAB		
-------	--------------	--	----------	--	--

TRANSMISSION FILTER ELEMENT

FT145	Freightliner	MB-II, MB-IV/G5 with Ford 6.0L Diesel Engine	P7247JAB		
-------	--------------	--	----------	--	--

TRANSMISSION FILTER ELEMENT - 2" KIT

29540493	Freightliner	C2 School Bus, FS-65 Bus with Caterpillar C7 Engine	PT9416MPGK1TJAB		
29540493	Freightliner	C2 School Bus, FS-65 Bus with Cummins ISB Engine	PT9416MPGK1TJAB		

TRANSMISSION FILTER ELEMENT - 2" KIT, 3000 SERIES

29540493	Freightliner	FS-65 Bus with Caterpillar 3126 Engine	PT9416MPGK1TJAB		
----------	--------------	--	-----------------	--	--

TRANSMISSION FILTER ELEMENT - 4" KIT

29540494	Freightliner	C2 School Bus, FS-65 Bus with Caterpillar C7 Engine	PT9415MPGK1TJAB		
29540494	Freightliner	C2 School Bus, FS-65 Bus with Cummins ISB Engine	PT9415MPGK1TJAB		

TRANSMISSION FILTER ELEMENT - 4" KIT, 3000 SERIES

29540494	Freightliner	FS-65 Bus with Caterpillar 3126 Engine	PT9415MPGK1TJAB		
----------	--------------	--	-----------------	--	--

TRANSMISSION FILTER ELEMENT - FOR 5R110W

FT145	Freightliner	MB-II with Ford 5.4L Gas Engine	P7247JAB		
FT145	Freightliner	MB-IV/G5 with Ford 5.4L Gas Engine	P7247JAB		

TRANSMISSION FILTER PAN-TYPE - 3.8" PAN, AT SERIES

29540976	Freightliner	FS-65 Bus with Caterpillar 3126 Engine	PT9415MPGK1TJAB		
29540976	Freightliner	FS-65 Bus with Caterpillar C7 Engine	PT9415MPGK1TJAB		
29540976	Freightliner	FS-65 Bus with Cummins ISB 5.9L Engine	PT9415MPGK1TJAB		

OEM Part Number	Manufacturer	Engine Make/Model	Baldwin	Fleetguard	Donaldson
-----------------	--------------	-------------------	---------	------------	-----------

TRANSMISSION FILTER PAN-TYPE - 5.3" PAN, AT SERIES

29538489	Freightliner	FS-65 Bus with Caterpillar 3126 Engine	19739JAB		
29538489	Freightliner	FS-65 Bus with Caterpillar C7 Engine	19739JAB		
29538489	Freightliner	FS-65 Bus with Cummins ISB 5.9L Engine	19739JAB		

TRANSMISSION FILTER PAN-TYPE - DEEP PAN WITH GASKET

29537966	Freightliner	B2 Bus Chassis, FS-65 Bus with Caterpillar C7 Engine	20003JAB		
29537966	Freightliner	B2 Bus Chassis, C2 School Bus with Cummins ISB Engine	20003JAB		
29537966	Freightliner	MB-II, MB-IV/G5 with GM 6.6L Diesel Engine	20017JAB		

TRANSMISSION FILTER PAN-TYPE - DEEP PAN WITH GASKET, 2000 SERIES

29537966	Freightliner	FS-65 Bus with Caterpillar 3126 Engine	20017JAB		
29537966	Freightliner	FS-65 Bus with Cummins ISB 5.9L Engine	20017JAB		

TRANSMISSION FILTER PAN-TYPE - DEEP PAN WITHOUT GASKET

29537966	Freightliner	MB-II, MB-IV/G5 with GM 6.6L Diesel Engine	20003JAB		
29537966	Freightliner	B2 Bus Chassis, FS-65 Bus, C2 School Bus with Caterpillar C7 Engine	20017JAB		
29537966	Freightliner	B2 Bus Chassis, C2 School Bus with Cummins ISB Engine	20017JAB		

TRANSMISSION FILTER PAN-TYPE - DEEP PAN WITHOUT GASKET, 2000 SERIES

29537966	Freightliner	FS-65 Bus with Caterpillar 3126 Engine	20003JAB		
29537966	Freightliner	FS-65 Bus with Cummins ISB 5.9L Engine	20003JAB		

TRANSMISSION FILTER PAN-TYPE - SHALLOW PAN WITH GASKET

29537965	Freightliner	B2 Bus Chassis, C2 School Bus, FS-65 Bus with Caterpillar C7 Engine	20016JAB		
29537965	Freightliner	B2 Bus Chassis, C2 School Bus with Cummins ISB Engine	20016JAB		
29537965	Freightliner	MB-II, MB-IV/G5 with GM 6.6L Diesel Engine	20016JAB		

TRANSMISSION FILTER PAN-TYPE - SHALLOW PAN WITH GASKET, 2000 SERIES

29537965	Freightliner	FS-65 Bus with Caterpillar 3126 Engine	20004JAB		
29537965	Freightliner	FS-65 Bus with Cummins ISB 5.9L Engine	20004JAB		

TRANSMISSION FILTER PAN-TYPE - SHALLOW PAN WITHOUT GASKET

29537965	Freightliner	B2 Bus Chassis, C2 School Bus, FS-65 Bus with Caterpillar C7 Engine	20004JAB		
29537965	Freightliner	B2 Bus Chassis, C2 School Bus with Cummins ISB Engine	20004JAB		
29537965	Freightliner	MB-II, MB-IV/G5 with GM 6.6L Diesel Engine	20004JAB		

TRANSMISSION FILTER PAN-TYPE - SHALLOW PAN WITHOUT GASKET, 2000 SERIES

29537965	Freightliner	FS-65 Bus with Caterpillar 3126 Engine	20016JAB		
29537965	Freightliner	FS-65 Bus with Cummins ISB 5.9L Engine	20016JAB		

OEM Part Number	Manufacturer	Engine Make/Model	Baldwin	Fleetguard	Donaldson
-----------------	--------------	-------------------	---------	------------	-----------

TRANSMISSION FILTER PAN-TYPE - MADE BEFORE NOVEMBER 2007

FT144	Freightliner	MB-II, MB-IV/G5 with Ford 6.0L Diesel Engine	20005JAB		
-------	--------------	--	----------	--	--

TRANSMISSION FILTER PAN-TYPE - MADE FROM 2007 TO PRESENT

FT180	Freightliner	MB-II, MB-IV/G5 with Ford 6.0L Diesel Engine	20021JAB		
-------	--------------	--	----------	--	--

TRANSMISSION FILTER, SPIN-ON

4304827	Freightliner	C2 School Bus with Cummins ISB Engine	BT223JAB		
4304827	Freightliner	C2 School Bus with Caterpillar C7 Engine	BT223JAB		
29539579	Freightliner	B2 Bus Chassis, C2 School Bus, FS-65 with Caterpillar C7 Engine	BT8460JAB		
29539579	Freightliner	B2 Bus Chassis, C2 School Bus with Cummins ISB Engine	BT8460JAB		
29539579	Freightliner	MB-II, MB-IV/G5 with GM 6.6L Diesel Engine	BT8460JAB		

GILLIG LLC

GILLIG LLC COOLANT FILTERS

Table 12-28: Coolant Filters for Gillig LLC

OEM Part Number	Manufacturer	Engine Make/Model	Baldwin	Fleetguard	Donaldson
-----------------	--------------	-------------------	---------	------------	-----------

COOLANT FILTER, SPIN-ON

WF2071	Gillig LLC	Low Floor, Phantom with Cummins ISL Engine			P552071
WF2075	Gillig LLC	Low Floor, Phantom with Cummins ISM Engine			P552075
WF2122	Gillig LLC	Low Floor, Phantom with Cummins ISM Engine			ECF4085

GILLIG LLC FUEL FILTERS

Table 12-29: Fuel Filters for Gillig LLC

OEM Part Number	Manufacturer	Engine Make/Model	Baldwin	Fleetguard	Donaldson
-----------------	--------------	-------------------	---------	------------	-----------

PRIMARY FUEL FILTER, SPIN-ON

FF5636	Gillig LLC	Low Floor, Phantom with Cummins ISL Engine			P550879
FS1065	Gillig LLC	Low Floor, Phantom with Cummins ISL Engine			P551103

GILLIG LLC FUEL/WATER SEPARATOR FILTERS

Table 12-30: Fuel/Water Separator Filters for Gillig LLC

OEM Part Number	Manufacturer	Engine Make/Model	Baldwin	Fleetguard	Donaldson
-----------------	--------------	-------------------	---------	------------	-----------

FUEL/WATER SEPARATOR FILTER, SPIN-ON

FS1000	Gillig LLC	Low Floor, Phantom with Cummins ISM Engine			P551000
FS1003	Gillig LLC	Low Floor, Phantom with Cummins ISL Engine			P551103
FS1003	Gillig LLC	Low Floor, Phantom with Cummins ISM Engine			P551103
FS1282	Gillig LLC	Low Floor, Phantom with Cummins ISM Engine			P550691

GILLIG LLC LUBE/OIL FILTERS

Table 12-31: Lube/Oil Filters for Gillig LLC

OEM Part Number	Manufacturer	Engine Make/Model	Baldwin	Fleetguard	Donaldson
COMBINATION LUBE FILTER, SPIN-ON					
LF9001	Gillig LLC	Low Floor, Phantom with Cummins ISM Engine			P559000
LF9009	Gillig LLC	Low Floor, Phantom with Cummins ISL Engine			P553000
LF9548	Gillig LLC	Low Floor, Phantom with Cummins ISL Engine			P553548

INTERNATIONAL/IC Bus

INTERNATIONAL/IC BUS AIR FILTERS

Table 12-32: Air Filters for International/ IC Bus

OEM Part Number	Manufacturer	Engine Make/Model	Baldwin	Fleetguard	Donaldson
AIR FILTER					
588213C1	International/IC Bus	2000 Series		AF1878FLG	
1674320C3	International/IC Bus	8100 Series		AF982MFLG	
476741-C1	International/IC Bus	RE with DT466 Engine	PA2521JAB		
AIR FILTER, MAGNUM RS					
2005895C1	International/IC Bus	9400 Series		AF25033MFLG	
2005895C1	International/IC Bus	9200 Series		AF25430FLG	
2022289C1	International/IC Bus	9200, 9400 Series		AF25430FLG	
INNER AIR FILTER					
482644-C1	International/IC Bus	3400, 3600, 3800 with T444E Engine	PA2522JAB		
482644-C1	International/IC Bus	3400, 3600, 3800 with DT466E Engine	PA2522JAB		
AF987	International/IC Bus	FE with DT360 Engine	PA2522JAB		
AF987	International/IC Bus	RE with T444E Engine	PA2522JAB		
AF987	International/IC Bus	3800 with DTA360 Engine	PA2522JAB		
OUTER AIR FILTER					
476741C1	International/IC Bus	FE with DT360 Engine	PA2521JAB		
476741C1	International/IC Bus	RE with T444E Engine	PA2521JAB		
476741C1	International/IC Bus	3400, 3600, 3800 with T444E Engine	PA2521JAB		
476741C1	International/IC Bus	3400, 3800 with DT466E Engine	PA2521JAB		
476741C1	International/IC Bus	3800 with DTA360 Engine	PA2521JAB		
476741C1	International/IC Bus	3800 with DT408 Engine	PA2521JAB		
PRIMARY AIR FILTER					
n/a	International/IC Bus	9400 Series		AF1832FLG	
420051C1	International/IC Bus	2070 Series Fleetstar with Cummins Engine		AF872FLG	
472098C1	International/IC Bus	5000 Series		AF928MFLG	
476741C1	International/IC Bus	8100 Series		AF979FLG	
n/a	International/IC Bus	2000 Series		AF979FLG AF982MFLG	
SECONDARY AIR FILTER					
n/a	International/IC Bus	8100 Series		AF987FLG AF364FLG	

OEM Part Number	Manufacturer	Engine Make/Model	Baldwin	Fleetguard	Donaldson
-----------------	--------------	-------------------	---------	------------	-----------

RADIAL SEAL AIR FILTER

1691027C1	International/IC Bus	3600 with DT466E Engine	RS2863JAB		
1691027C1	International/IC Bus	3400, 3600, 3800 with T444E Engine	RS2863JAB		
1691027-C1	International/IC Bus	3600, 3800 with DTA360 Engine	RS2863JAB		
3532799-C1	International/IC Bus	BE, CE with MaxxForce 7 Engine	RS4636JAB		

RADIAL SEAL INNER AIR FILTER

3532800-C1	International/IC Bus	CE with DT466 Engine	RS4637JAB		
3532800-C1	International/IC Bus	CE with MaxxForce 7 Engine	RS4637JAB		
3532800-C1	International/IC Bus	CE with MaxxForce DT Engine	RS4637JAB		

RADIAL SEAL OUTER AIR FILTER

3532799-C1	International/IC Bus	CE with DT466 Engine	RS4636JAB		
3532799-C1	International/IC Bus	CE with MaxxForce DT Engine	RS4636JAB		

SINGLE AIR FILTER

1661755C91	International/IC Bus	3800 with DTA360 Engine	PA2521JAB		
------------	----------------------	-------------------------	-----------	--	--

INTERNATIONAL/IC BUS COOLANT FILTERS

Table 12-33: Coolant Filters for International/ IC Bus

OEM Part Number	Manufacturer	Engine Make/Model	Baldwin	Fleetguard	Donaldson
-----------------	--------------	-------------------	---------	------------	-----------

COOLANT FILTER

1822627-C1	International/IC Bus	3600, 3800 with T444E Engine	BW5071JAB		
1822313-C1	International/IC Bus	3800 with DT408 Engine	BW5082JAB		

COOLANT FILTER - WITH 4 UNITS BALANCED TREATMENT ADDITIVE PLUS

WF2071	International/IC Bus	3400 with T444E Engine	BW5071JAB		
WF2071	International/IC Bus	3600 with DTA360 Engine	BW5071JAB		
WF2071	International/IC Bus	3800 with DT466E Engine	BW5071JAB		
1822313-C1	International/IC Bus	3600, 3800, FE with DT466E Engine	BW5082JAB		

COOLANT FILTER - WITH 6 UNITS BALANCED TREATMENT ADDITIVE PLUS

WF2072	International/IC Bus	3600, 3800, FE with DTA360 Engine	BW5072JAB		
WF2072	International/IC Bus	3800 with DT466E Engine	BW5072JAB		

COOLANT FILTER - WITH 8 UNITS BALANCED TREATMENT ADDITIVE PLUS

WF2073	International/IC Bus	3600, 3800, FE with DTA360 Engine	BW5073JAB		
WF2073	International/IC Bus	3800 with DT466E Engine	BW5073JAB		

OEM Part Number	Manufacturer	Engine Make/Model	Baldwin	Fleetguard	Donaldson
-----------------	--------------	-------------------	---------	------------	-----------

COOLANT FILTER - WITH 8 UNITS BALANCED TREATMENT FOR ETHYLENE GLYCOL

1801089-C1	International/IC Bus	3800 with T444E Engine	BW5139JAB		
------------	----------------------	------------------------	-----------	--	--

COOLANT FILTER - WITH 12 UNITS BALANCED TREATMENT ADDITIVE PLUS

1820361-C1	International/IC Bus	FE with DT466 Engine	BW5074JAB		
1820361-C1	International/IC Bus	3800 with DT466E Engine	BW5074JAB		
WF2074	International/IC Bus	FE with DT360 Engine	BW5074JAB		
WF2074	International/IC Bus	3600, 3800 with DTA360 Engine	BW5074JAB		
WF2074	International/IC Bus	3600 with DT466E Engine	BW5074JAB		

COOLANT FILTER - WITH 15 UNITS BALANCED TREATMENT ADDITIVE PLUS

WF2075	International/IC Bus	3600, 3800, FE with DTA360 Engine	BW5075JAB		
WF2075	International/IC Bus	3800 with DT466E Engine	BW5075JAB		

COOLANT FILTER - WITHOUT CHEMICALS

1825314-C1	International/IC Bus	3400 with T444E Engine	B5089JAB		
WF2101	International/IC Bus	3600, 3800, FE with DT466E Engine	B5134JAB		

INTERNATIONAL/IC BUS FUEL FILTERS

Table 12-34: Fuel Filters for International/ IC Bus

OEM Part Number	Manufacturer	Engine Make/Model	Baldwin	Fleetguard	Donaldson
-----------------	--------------	-------------------	---------	------------	-----------

FUEL FILTER

672603-C2	International/IC Bus	3800 with DT408 Engine	BF588JAB		
1820479-C1	International/IC Bus	FE with DT466 Engine	BF7531JAB		
1820479-C1	International/IC Bus	3800 with DT466E Engine	BF7531JAB		
1809789-C1	International/IC Bus	RE with DT466 Engine	BF7629JAB		
1822588-C1	International/IC Bus	FE with DT466 Engine	BF7629JAB		
1822588-C1	International/IC Bus	3400, 3600, 3800 with DT466E Engine	BF7629JAB		
1822588-C1	International/IC Bus	3400, 3600, 3800 with DTA360 Engine	BF7629JAB		
3903640	International/IC Bus	3600 with DT466E Engine	BF788JAB		
FF5052	International/IC Bus	3800 with DT466E Engine	BF788JAB		
FF105D	International/IC Bus	3600, 3800 with DTA360 Engine	BF957DJAB		
1822631C91	International/IC Bus	RE with T444E Engine	PF7678JAB		
1822638-C91	International/IC Bus	CE, FE, RE with MaxxForce DT Engine	PF7779JAB		
1842638-C91	International/IC Bus	CE with DT466 Engine	PF7779JAB		

OEM Part Number	Manufacturer	Engine Make/Model	Baldwin	Fleetguard	Donaldson
FUEL FILTER - MADE FROM 1999 TO PRESENT					
1825864-C92	International/IC Bus	3400, 3800 with T444E Engine	PF7698JAB		
FUEL FILTER - MADE FROM 1994 TO 1998					
1822631-C91	International/IC Bus	3400, 3600, 3800 with T444E Engine	PF7678JAB		
FUEL FILTER - MADE FROM 1993 TO PRESENT					
1822588-C1	International/IC Bus	FE with DT360 Engine	BF7629JAB		
FUEL FILTER, CARTRIDGE					
n/a	International/IC Bus	2050 Series Fleetstar with IHC DT466 Engine		FF184FLG FF5019FLG	
FUEL FILTER, SPIN-ON					
1820479C1	International/IC Bus	3600 with T444E Engine	BF7531JAB		
1822588C1	International/IC Bus	3600 with T444E Engine	BF7629JAB		
FUEL STRAINER FILTER					
1873910-C91	International/IC Bus	BE, CE with MaxxForce 7 Engine	PF7994JAB		
1873910-C91	International/IC Bus	CE, FE, RE with MaxxForce DT Engine	PF7994JAB		
PRIMARY FUEL FILTER - ENGINES WITH S/N 567492 TO 599779					
625627-C1	International/IC Bus	3800 with DT466E Engine	BF979JAB		
SECONDARY FUEL FILTER - ENGINES WITH S/N 567492-ON					
672603-C3	International/IC Bus	3800 with DT466E Engine	BF588JAB		

INTERNATIONAL/IC BUS FUEL/WATER SEPARATOR FILTERS

Table 12-35: Fuel/Water Separator Filters for International/ IC Bus

OEM Part Number	Manufacturer	Engine Make/Model	Baldwin	Fleetguard	Donaldson
FUEL/WATER SEPARATOR CARTRIDGE FILTER					
n/a	International/IC Bus	9200 Series		FS1206FLG	
FUEL/WATER SEPARATOR FILTER					
1693965-C91	International/IC Bus	3800 with DTA360 Engine	BF1347JAB		
S3226T	International/IC Bus	3800 with DT466E Engine	BF1347JAB		
1808623-C1	International/IC Bus	FE with DT360 Engine	BF7584JAB		
FF105D	International/IC Bus	FE with DT360 Engine	BF957DJAB		
1878042-C91	International/IC Bus	BE, CE with MaxxForce 7 Engine	PF7978JAB		
1878042-C91	International/IC Bus	CE, FE, RE with MaxxForce DT Engine	PF7978JAB		
1808623-C1	International/IC Bus	3600, 3800 with DTA360 Engine	BF7584JAB		

OEM Part Number	Manufacturer	Engine Make/Model	Baldwin	Fleetguard	Donaldson
702255-C1	International/IC Bus	3600 with DTA360 Engine	BF891JAB		
702255-C1	International/IC Bus	3800 with DT466E Engine	BF891JAB		
FS1205	International/IC Bus	3800 with DT466E Engine	BF912JAB		
FUEL/WATER SEPARATOR FILTER - BOX-STYLE					
FSR81205	International/IC Bus	FE with DT360 Engine	BF912JAB		
FSR81205	International/IC Bus	FE with DT466 Engine	BF912JAB		
FUEL/WATER SEPARATOR FILTER - ENGINES WITH S/N 618496-ON					
FF105D	International/IC Bus	3800 with DT466E Engine	BF957DJAB		
FUEL/WATER SEPARATOR FILTER - WITH SENSOR PORT					
1618385-C91	International/IC Bus	3800 with T444E Engine	BF1345SPJAB		
1618386-C92	International/IC Bus	3800 with DTA360 Engine	BF1345SPJAB		
1618386-C93	International/IC Bus	3800 with DT466E Engine	BF1345SPJAB		
1677004-C91	International/IC Bus	3600 with DT466E Engine	BF1345SPJAB		
1677004C-91	International/IC Bus	RE with DT466 Engine	BF1345SPJAB		
FUEL/WATER SEPARATOR FILTER - WITH SENSOR PORT, SPIN-ON					
1618386-C92	International/IC Bus	FE with DT466 Engine	BF1345SPJAB		
FUEL/WATER SEPARATOR FILTER - WITHOUT SENSOR PORT					
1618385-C91	International/IC Bus	3800 with T444E Engine	BF1345JAB		
1618386-C92	International/IC Bus	3800 with DTA360 Engine	BF1345JAB		
1618386-C93	International/IC Bus	3800 with DT466E Engine	BF1345JAB		
1677004-C91	International/IC Bus	3600 with DT466E Engine	BF1345JAB		
1677004C-91	International/IC Bus	RE with DT466 Engine	BF1345JAB		
FUEL/WATER SEPARATOR FILTER - WITHOUT SENSOR PORT, SPIN-ON					
1618386-C92	International/IC Bus	FE with DT466 Engine	BF1345JAB		
FUEL/WATER SEPARATOR FILTER, SPIN-ON					
1693965-C91	International/IC Bus	FE with DT466 Engine	BF1347JAB		

INTERNATIONAL/IC BUS LUBE/OIL FILTERS

Table 12-36: Lube/Oil Filters for International/ IC Bus

OEM Part Number	Manufacturer	Engine Make/Model	Baldwin	Fleetguard	Donaldson
DUAL-FLOW LUBE FILTER - MADE FROM 2005 TO PRESENT					
1842639-C91	International/IC Bus	CE with DT466 Engine	BD7250JAB		
FULL-FLOW LUBE FILTER					
1833121-C1	International/IC Bus	FE with DT466 Engine	B7030JAB		

OEM Part Number	Manufacturer	Engine Make/Model	Baldwin	Fleetguard	Donaldson
-----------------	--------------	-------------------	---------	------------	-----------

FULL-FLOW LUBE FILTER - MADE BEFORE 2005

1819452-C1	International/IC Bus	CE, RE with DT466 Engine	B7030JAB		
------------	----------------------	--------------------------	----------	--	--

FULL-FLOW LUBE FILTER, SPIN-ON

1808896C1	International/IC Bus	2050 Series Fleetstar with IHC DT466 Engine		LF3420FLG	
1811953C1	International/IC Bus	2050 Series Fleetstar with IHC DT466 Engine		LF3455FLG	

LUBE FILTER

1819452-C1	International/IC Bus	3800 with DT408 Engine	B7030JAB		
1811953C1	International/IC Bus	3800 with DTA360 Engine	B309JAB		
1811953-C1	International/IC Bus	FE with DT360 Engine	B309JAB		
1811953-C1	International/IC Bus	3600, 3800 with DTA360 Engine	B309JAB		
1819452-C1	International/IC Bus	3400, 3600, 3800 with DT466E Engine	B7030JAB		
1814562C1	International/IC Bus	RE with T444E Engine	B7039JAB		
1814562-C1	International/IC Bus	3400, 3600, 3800 with T444E Engine	B7039JAB		
1842639-C91	International/IC Bus	CE, FE, RE with MaxxForce DT Engine	BD7250JAB		
LF3420	International/IC Bus	FE with DT360 Engine	BT261JAB		
LF3420	International/IC Bus	3600 with DTA360 Engine	BT261JAB		

LUBE FILTER - WITHOUT SCREW-ON CAP

1840752C91	International/IC Bus	BE, CE with MaxxForce 7 Engine	P7235JAB		
------------	----------------------	--------------------------------	----------	--	--

LUBE FILTER, CARTRIDGE

279294C91	International/IC Bus	2050 Series Fleetstar with IHC DT466 Engine		LF634FLG	
279294C92	International/IC Bus	8100, 9200, 9400 Series		LF634FLG	

INTERNATIONAL/IC BUS STEERING FILTERS

Table 12-37: Steering Filters for International/ IC Bus

OEM Part Number	Manufacturer	Engine Make/Model	Baldwin	Fleetguard	Donaldson
-----------------	--------------	-------------------	---------	------------	-----------

POWER STEERING FILTER

598698C1	International/IC Bus	9200, 9400 Series		LF637FLG	
----------	----------------------	-------------------	--	----------	--

STEERING FILTER

1691121C1	International/IC Bus	RE with MaxxForce DT Engine	P106HDJAB		
1695528-C1	International/IC Bus	3800 with DTA360 Engine	PT9419MPGJAB		

STEERING FILTER

2503221C1	International/IC Bus	BE, CE with MaxxForce 7 Engine	BT9388JAB		
2503221C1	International/IC Bus	CE, FE, RE with DT466 Engine	BT9388JAB		

OEM Part Number	Manufacturer	Engine Make/Model	Baldwin	Fleetguard	Donaldson
-----------------	--------------	-------------------	---------	------------	-----------

2503221C1	International/IC Bus	CE, FE, RE with MaxxForce DT Engine	BT9388JAB		
1691121C1	International/IC Bus	RE with DT466 Engine	P106HDJAB		
1691121-C1	International/IC Bus	3400, 3600, 3800 with T444E Engine	P106HDJAB		
HF6162	International/IC Bus	RE with T444E Engine	P106HDJAB		
1695528-C1	International/IC Bus	3400, 3600, 3800 with T444E Engine	PT9419MPGJAB		

STEERING FILTER - 2-25/32"

LF634	International/IC Bus	FE with DT466 Engine	PT903JAB		
-------	----------------------	----------------------	----------	--	--

STEERING FILTER - 3-31/32"

1691121C1	International/IC Bus	3400, 3600, 3800 with DT466E Engine	P106HDJAB		
HF6162	International/IC Bus	FE with DT466 Engine	P106HDJAB		
HF6162	International/IC Bus	3600, 3800 with DTA360 Engine	P106HDJAB		

STEERING FILTER - 5-1/32"

1695528C1	International/IC Bus	3600 with DT466E Engine	PT9419MPGJAB		
-----------	----------------------	-------------------------	--------------	--	--

STEERING FILTER - MADE BEFORE AUGUST 1991

1681202C91	International/IC Bus	3600, 3800 with DTA360 Engine	PT8407JAB		
1681202C91	International/IC Bus	3800 with DT408 Engine	PT8407JAB		
1681202C91	International/IC Bus	3600, 3800 with T444E Engine	PT8407JAB		
1681202C91	International/IC Bus	3800 with DT466E Engine	PT8407JAB		

STEERING FILTER - MADE FROM 1991 TO PRESENT

1691121C1	International/IC Bus	3800 with DT408 Engine	P106HDJAB		
-----------	----------------------	------------------------	-----------	--	--

INTERNATIONAL/IC BUS TRANSMISSION FILTERS

Table 12-38: Transmission Filters for International/ IC Bus

OEM Part Number	Manufacturer	Engine Make/Model	Baldwin	Fleetguard	Donaldson
-----------------	--------------	-------------------	---------	------------	-----------

TRANSMISSION FILTER

595722-C91	International/IC Bus	FE with DT360 Engine	BT83910JAB		
------------	----------------------	----------------------	------------	--	--

TRANSMISSION FILTER ELEMENT - 2" KIT

29540493	International/IC Bus	CE, FE, RE with DT466 Engine	PT9416MPGK1TJAB		
29540493	International/IC Bus	CE with MaxxForce 7 Engine	PT9416MPGK1TJAB		
29540493	International/IC Bus	CE, FE, RE with MaxxForce DT Engine	PT9416MPGK1TJAB		
29540493	International/IC Bus	RE with T444E Engine	PT9416MPGK1TJAB		

OEM Part Number	Manufacturer	Engine Make/Model	Baldwin	Fleetguard	Donaldson
-----------------	--------------	-------------------	---------	------------	-----------

TRANSMISSION FILTER ELEMENT - 4" KIT

29540494	International/IC Bus	CE, FE, RE with DT466 Engine	PT9415MPGK1TJAB		
29540494	International/IC Bus	CE with MaxxFORCE 7 Engine	PT9415MPGK1TJAB		
29540494	International/IC Bus	CE, FE, RE with MaxxFORCE DT Engine	PT9415MPGK1TJAB		
29540494	International/IC Bus	RE with T444E Engine	PT9415MPGK1TJAB		

TRANSMISSION FILTER PAN-TYPE

29538489	International/IC Bus	FE with DT466 Engine	19739JAB		
----------	----------------------	----------------------	----------	--	--

TRANSMISSION FILTER PAN-TYPE - 3.8" PAN

29540976	International/IC Bus	3400, 3600, 3800 with T444E Engine	PT9415MPGK1TJAB		
29540976	International/IC Bus	3400, 3600, 3800 with DT466E Engine	PT9415MPGK1TJAB		
29540976	International/IC Bus	3600, 3800 with DTA360 Engine	PT9415MPGK1TJAB		
29540976	International/IC Bus	3800 with DT408 Engine	PT9415MPGK1TJAB		

TRANSMISSION FILTER PAN-TYPE - 5.3" PAN

29538489	International/IC Bus	3400, 3600, 3800 with T444E Engine	19739JAB		
29538489	International/IC Bus	3400, 3600, 3800 with DT466E Engine	19739JAB		
29538489	International/IC Bus	3600, 3800 with DTA360 Engine	19739JAB		
29538489	International/IC Bus	3800 with DT408 Engine	19739JAB		

TRANSMISSION FILTER PAN-TYPE - DEEP PAN WITH GASKET

29537966	International/IC Bus	BE, CE with MaxxFORCE 7 Engine	20017JAB		
29537966	International/IC Bus	CE, FE, RE with DT466 Engine	20017JAB		
29537966	International/IC Bus	CE, FE with MaxxFORCE DT Engine	20017JAB		

TRANSMISSION FILTER PAN-TYPE - DEEP PAN WITHOUT GASKET

25937966	International/IC Bus	FE with DT466 Engine	20003JAB		
29537966	International/IC Bus	BE, CE with MaxxFORCE 7 Engine	20003JAB		
29537966	International/IC Bus	CE, RE with DT466 Engine	20003JAB		
29537966	International/IC Bus	CE, FE with MaxxFORCE DT Engine	20003JAB		

TRANSMISSION FILTER PAN-TYPE - SHALLOW PAN WITH GASKET

29537965	International/IC Bus	BE, CE with MaxxFORCE 7 Engine	20016JAB		
29537965	International/IC Bus	CE, FE, RE with DT466 Engine	20016JAB		
29537965	International/IC Bus	CE, FE with MaxxFORCE DT Engine	20016JAB		

TRANSMISSION FILTER PAN-TYPE - SHALLOW PAN WITHOUT GASKET

29537965	International/IC Bus	BE, CE with MaxxFORCE 7 Engine	20004JAB		
29537965	International/IC Bus	CE, FE, RE with DT466 Engine	20004JAB		
29537965	International/IC Bus	CE, FE with MaxxFORCE DT Engine	20004JAB		

OEM Part Number	Manufacturer	Engine Make/Model	Baldwin	Fleetguard	Donaldson
-----------------	--------------	-------------------	---------	------------	-----------

TRANSMISSION FILTER, SPIN-ON

29510922	International/IC Bus	FE with DT466 Engine	BT8316MPGJAB		
595722-C91	International/IC Bus	FE with DT466 Engine	BT83910JAB		
29539579	International/IC Bus	BE, CE with MaxxFORCE 7 Engine	BT8460JAB		
29539579	International/IC Bus	CE, FE, RE with DT466 Engine	BT8460JAB		
29539579	International/IC Bus	CE, FE with MaxxFORCE DT Engine	BT8460JAB		
23042062	International/IC Bus	3600 with T444E Engine	BT8316MPGJAB		
29510922	International/IC Bus	3400, 3800 with T444E Engine	BT8316MPGJAB		
29510922	International/IC Bus	3400, 3600, 3800 with DT466E Engine	BT8316MPGJAB		
29510922	International/IC Bus	3600, 3800 with DTA360 Engine	BT8316MPGJAB		
595722-C91	International/IC Bus	3600 with DTA360 Engine	BT83910JAB		
595722-C91	International/IC Bus	3600, 3800 with T444E Engine	BT83910JAB		
596606-C1	International/IC Bus	3400 with T444E Engine	BT83910JAB		
596606-C1	International/IC Bus	3400, 3600 with DT466E Engine	BT83910JAB		
29510922	International/IC Bus	3800 with DT408 Engine	BT8316MPGJAB		
595722-C91	International/IC Bus	3800 with DT408 Engine	BT83910JAB		
595722-C91	International/IC Bus	3800 with DT466E Engine	BT83910JAB		

MID BUS

MID BUS AIR FILTERS

Table 12-39: Air Filters for Mid Bus

OEM Part Number	Manufacturer	Engine Make/Model	Baldwin	Fleetguard	Donaldson
-----------------	--------------	-------------------	---------	------------	-----------

AIR FILTER

FA1632	Mid Bus	Guide with Ford 5.4L Gas Engine	PA4075JAB		
--------	---------	---------------------------------	-----------	--	--

CHANNEL FLOW AIR FILTER

FA1746	Mid Bus	Guide, Grand Guide, Super Guide with Ford 6.0L Diesel Engine	CA4999JAB		
--------	---------	--	-----------	--	--

RADIAL SEAL AIR FILTER

A1621C	Mid Bus	Guide with GM 4.8L Gas Engine	RS4131JAB		
A1621C	Mid Bus	Guide, Grand Guide, Super Guide with GM 6.0L Gas Engine	RS4131JAB		
A2032C	Mid Bus	Guide, Grand Guide, Super Guide with GM 6.6L Diesel Engine	RS4859JAB		

MID BUS FUEL FILTERS

Table 12-40: Fuel Filters for Mid Bus

OEM Part Number	Manufacturer	Engine Make/Model	Baldwin	Fleetguard	Donaldson
-----------------	--------------	-------------------	---------	------------	-----------

FUEL FILTER

FG986B	Mid Bus	Guide with Ford 5.4L Gas Engine	BF7668JAB		
FD4606	Mid Bus	Guide, Grand Guide, Super Guide with Ford 6.0L Diesel Engine	PF7852K1T-JAB		

FUEL FILTER - MADE FROM 2003 TO 2005, THREAD BOTH ENDS

GF652	Mid Bus	Guide with GM 4.8L Gas Engine	BF3283JAB		
GF652	Mid Bus	Guide with GM 6.0L Gas Engine	BF3553JAB		
GF652	Mid Bus	Grand Guide with GM 6.0L Gas Engine	BF3823JAB		
GF652	Mid Bus	Super Guide with GM 6.0L Gas Engine	BF4093JAB		

FUEL FILTER - MADE FROM 2003 TO 2005, THREAD ONE END

6F578	Mid Bus	Guide with GM 4.8L Gas Engine	BF1171JAB		
GF578	Mid Bus	Guide, Grand Guide, Super Guide with GM 6.0L Gas Engine	BF1171JAB		

MID BUS FUEL/WATER SEPARATOR FILTERS

Table 12-41: Fuel/Water Separator Filters for Mid Bus

OEM Part Number	Manufacturer	Engine Make/Model	Baldwin	Fleetguard	Donaldson
-----------------	--------------	-------------------	---------	------------	-----------

FUEL/WATER SEPARATOR FILTER

TP1298B	Mid Bus	Guide, Grand Guide, Super Guide with GM 6.6L Diesel Engine	BF7827JAB		
---------	---------	--	-----------	--	--

MID BUS LUBE/OIL FILTERS

Table 12-42: Lube/Oil Filters for Mid Bus

OEM Part Number	Manufacturer	Engine Make/Model	Baldwin	Fleetguard	Donaldson
-----------------	--------------	-------------------	---------	------------	-----------

LUBE FILTER

PF2232	Mid Bus	Guide, Grand Guide, Super Guide with GM 6.6L Diesel Engine	B1441JAB		
FL820S	Mid Bus	Guide with Ford 5.4L Gas Engine	B329JAB		

LUBE FILTER - MADE FROM 2003 TO 2005

PF46	Mid Bus	Guide with GM 4.8L Gas Engine	B31JAB		
------	---------	-------------------------------	--------	--	--

LUBE FILTER - MADE FROM 2003 TO 2006

PF46	Mid Bus	Guide, Grand Guide, Super Guide with GM 6.0L Gas Engine	B31JAB		
------	---------	---	--------	--	--

LUBE FILTER - MADE FROM 2006 TO PRESENT

n/a	Mid Bus	Guide with GM 4.8L Gas Engine	B160JAB		
-----	---------	-------------------------------	---------	--	--

LUBE FILTER - MADE FROM 2007 TO PRESENT

n/a	Mid Bus	Guide, Grand Guide, Super Guide with GM 6.0L Gas Engine	B160JAB		
-----	---------	---	---------	--	--

LUBE FILTER - WITHOUT SCREW-ON CAP

FL2016	Mid Bus	Guide, Grand Guide, Super Guide with Ford 6.0L Diesel Engine	P7235JAB		
--------	---------	--	----------	--	--

MID BUS STEERING FILTERS

Table 12-43: Steering Filters for Mid Bus

OEM Part Number	Manufacturer	Engine Make/Model	Baldwin	Fleetguard	Donaldson
STEERING FILTER					
88892858	Mid Bus	Guide, Grand Guide, Super Guide with GM 6.6L Diesel Engine	P106HDJAB		

MID BUS TRANSMISSION FILTERS

Table 12-44: Transmission Filters for Mid Bus

OEM Part Number	Manufacturer	Engine Make/Model	Baldwin	Fleetguard	Donaldson
TRANSMISSION FILTER - DEEP PAN, FOR 4L60E					
24208576	Mid Bus	Guide with GM 4.8L Gas Engine	18056JAB		
24208576	Mid Bus	Guide, Grand Guide, Super Guide with GM 6.0L Gas Engine	18056JAB		
TRANSMISSION FILTER - DEEP PAN, FOR 4R100					
FT114	Mid Bus	Guide with Ford 5.4L Gas Engine	18265JAB		
TRANSMISSION FILTER - SHALLOW PAN, FOR 4L60E					
24200796	Mid Bus	Guide with GM 4.8L Gas Engine	18010JAB		
24200796	Mid Bus	Guide, Grand Guide, Super Guide with GM 6.0L Gas Engine	18010JAB		
TRANSMISSION FILTER - SHALLOW PAN, FOR 4R100					
FT113	Mid Bus	Guide with Ford 5.4L Gas Engine	18264JAB		
TRANSMISSION FILTER - FOR 4L80E					
24210956	Mid Bus	Guide with GM 4.8L Gas Engine	18027JAB		
24210956	Mid Bus	Guide, Grand Guide, Super Guide with GM 6.0L Gas Engine	18027JAB		
TRANSMISSION FILTER - FOR 4R70W					
FT105	Mid Bus	Guide with Ford 5.4L Gas Engine	18029JAB		
TRANSMISSION FILTER - FOR 5R110W, MADE BEFORE NOVEMBER 2007					
FT144	Mid Bus	Guide with Ford 5.4L Gas Engine	20005JAB		
TRANSMISSION FILTER - FOR 5R110W, MADE FROM 2007 TO PRESENT					
FT180	Mid Bus	Guide with Ford 5.4L Gas Engine	20021JAB		

OEM Part Number	Manufacturer	Engine Make/Model	Baldwin	Fleetguard	Donaldson
TRANSMISSION FILTER ELEMENT					
FT145	Mid Bus	Guide, Grand Guide, Super Guide with Ford 6.0L Diesel Engine	P7247JAB		
TRANSMISSION FILTER ELEMENT - FOR 5R110W					
FT145	Mid Bus	Guide with Ford 5.4L Gas Engine	P7247JAB		
TRANSMISSION FILTER PAN-TYPE - DEEP PAN WITH GASKET					
29537966	Mid Bus	Guide, Grand Guide, Super Guide with GM 6.6L Diesel Engine	20017JAB		
TRANSMISSION FILTER PAN-TYPE - DEEP PAN WITHOUT GASKET					
29537966	Mid Bus	Guide, Grand Guide, Super Guide with GM 6.6L Diesel Engine	20003JAB		
TRANSMISSION FILTER PAN-TYPE - SHALLOW PAN WITH GASKET					
29537965	Mid Bus	Guide, Grand Guide, Super Guide with GM 6.6L Diesel Engine	20016JAB		
TRANSMISSION FILTER PAN-TYPE - SHALLOW PAN WITHOUT GASKET					
29537965	Mid Bus	Guide, Grand Guide, Super Guide with GM 6.6L Diesel Engine	20004JAB		
TRANSMISSION FILTER PAN-TYPE - MADE BEFORE NOVEMBER 2007					
FT144	Mid Bus	Guide, Grand Guide, Super Guide with Ford 6.0L Diesel Engine	20005JAB		
TRANSMISSION FILTER PAN-TYPE - MADE FROM 2007 TO PRESENT					
FT180	Mid Bus	Guide, Grand Guide with Ford 6.0L Diesel Engine	20021JAB		
TRANSMISSION FILTER, SPIN-ON					
29539579	Mid Bus	Guide, Grand Guide, Super Guide with GM 6.6L Diesel Engine	BT8460JAB		

THOMAS BUILT

THOMAS BUILT AIR FILTERS

Table 12-45: Air Filters for Thomas Built

OEM Part Number	Manufacturer	Engine Make/Model	Baldwin	Fleetguard	Donaldson
-----------------	--------------	-------------------	---------	------------	-----------

CHANNEL FLOW AIR FILTER

P607955	Thomas Built	Saf-T-Liner with Caterpillar C7 Engine	CA4700JAB		
P607955	Thomas Built	Saf-T-Liner with Cummins ISB Engine	CA4700JAB		
P607955	Thomas Built	Saf-T-Liner with Cummins ISC Engine	CA4700JAB		
P607955	Thomas Built	Saf-T-Liner with John Deere 6081 8.1L Clear Natural Gas Engine	CA4700JAB		
P67955	Thomas Built	Saf-T-Liner with Caterpillar 3126 Engine	CA4700JAB		

CHANNEL FLOW AIR FILTER - WITH FLAME RETARDANT MEDIA

P607960	Thomas Built	Saf-T-Liner with Caterpillar C7 Engine	CA5420JAB		
P607960	Thomas Built	Saf-T-Liner with Caterpillar 3126 Engine	CA5420JAB		
P607960	Thomas Built	Saf-T-Liner with Cummins ISB Engine	CA5420JAB		
P607960	Thomas Built	Saf-T-Liner with Cummins ISC Engine	CA5420JAB		
P607960	Thomas Built	Saf-T-Liner with John Deere 6081 8.1L Clear Natural Gas Engine	CA5420JAB		

CHANNEL FLOW SAFETY AIR FILTER

P544432	Thomas Built	Saf-T-Liner with Caterpillar C7 Engine	PA4701JAB		
P544432	Thomas Built	Saf-T-Liner with Caterpillar 3126 Engine	PA4701JAB		
P544432	Thomas Built	Saf-T-Liner with Cummins ISB Engine	PA4701JAB		
P544432	Thomas Built	Saf-T-Liner with Cummins ISC Engine	PA4701JAB		
P544432	Thomas Built	Saf-T-Liner with John Deere 6081 8.1L Clear Natural Gas Engine	PA4701JAB		

DISPOSABLE AIR FILTER HOUSING

61100179	Thomas Built	Saf-T-Liner with Caterpillar C7 Engine	PA3891JAB		
61100179	Thomas Built	Saf-T-Liner with Caterpillar 3126 Engine	PA3891JAB		
61100179	Thomas Built	Saf-T-Liner with Cummins ISB Engine	PA3891JAB		
61100179	Thomas Built	Saf-T-Liner with Cummins ISC Engine	PA3891JAB		
61100179	Thomas Built	Saf-T-Liner with John Deere 6081 8.1L Clear Natural Gas Engine	PA3891JAB		

OPTIONAL STANDARD INNER AIR FILTER

482647-C91	Thomas Built	Vista with IHC DT360 Engine	PA2522JAB		
482647-C91	Thomas Built	Vista with IHC DT408 Engine	PA2522JAB		
482647-C91	Thomas Built	Vista with IHC DT466 Engine	PA2522JAB		
482647-C91	Thomas Built	Vista with IHC T444E (7.3L) Engine	PA2522JAB		

OEM Part Number	Manufacturer	Engine Make/Model	Baldwin	Fleetguard	Donaldson
-----------------	--------------	-------------------	---------	------------	-----------

RADIAL SEAL AIR FILTER

1691027-C1	Thomas Built	Vista with IHC DT360 Engine	RS2863JAB		
1691027-C1	Thomas Built	Vista with IHC DT408 Engine	RS2863JAB		
1691027-C1	Thomas Built	Vista with IHC T444E (7.3L) Engine	RS2863JAB		
1691027-C1	Thomas Built	Vista with IHC DT466 Engine	RS2863JAB		

STANDARD OUTER AIR FILTER

482647-C91	Thomas Built	Vista with IHC DT360 Engine	PA2521JAB		
482647-C91	Thomas Built	Vista with IHC DT408 Engine	PA2521JAB		
482647-C91	Thomas Built	Vista with IHC T444E (7.3L) Engine	PA2521JAB		
482647-C91	Thomas Built	Vista with IHC DT466 Engine	PA2521JAB		

THOMAS BUILT COOLANT FILTERS

Table 12-46: Coolant Filters for Thomas Built

OEM Part Number	Manufacturer	Engine Make/Model	Baldwin	Fleetguard	Donaldson
-----------------	--------------	-------------------	---------	------------	-----------

COOLANT FILTER - WITH CHEMICAL

1822313-C1	Thomas Built	Vista with IHC DT466 Engine	BW5082JAB		
------------	--------------	-----------------------------	-----------	--	--

COOLANT FILTER - WITHOUT CHEMICAL

1820358-C1	Thomas Built	Vista with IHC DT466 Engine	B5134JAB		
------------	--------------	-----------------------------	----------	--	--

THOMAS BUILT FUEL FILTERS

Table 12-47: Fuel Filters for Thomas Built

OEM Part Number	Manufacturer	Engine Make/Model	Baldwin	Fleetguard	Donaldson
-----------------	--------------	-------------------	---------	------------	-----------

FUEL ELEMENT FILTER - MADE FROM 1996 TO PRESENT

1822631-C91	Thomas Built	Vista with IHC T444E (7.3L) Engine	PF7678JAB		
-------------	--------------	------------------------------------	-----------	--	--

FUEL FILTER

674293-C91	Thomas Built	Vista with IHC DT466 Engine	BF588JAB		
1809789-C1	Thomas Built	Vista with IHC DT360 Engine	BF7629JAB		
1822588-C1	Thomas Built	Vista with IHC DT408 Engine	BF7629JAB		

OEM Part Number	Manufacturer	Engine Make/Model	Baldwin	Fleetguard	Donaldson
1R0751	Thomas Built	Saf-T-Liner with Caterpillar C7 Engine	BF7632JAB		
1R0751	Thomas Built	Saf-T-Liner with Caterpillar 3126 Engine	BF7632JAB		
FF5636	Thomas Built	Saf-T-Liner with Cummins ISC Engine	BF7924JAB		

FUEL FILTER - MADE FROM 2007 TO PRESENT

FF5632	Thomas Built	Saf-T-Liner with Cummins ISB Engine	BF7940JAB		
--------	--------------	-------------------------------------	-----------	--	--

PRIMARY FUEL FILTER, SPIN-ON

FF5632	Thomas Built	Saf-T-Liner MVP with Cummins ISB Engine			P550880
FS1065	Thomas Built	Saf-T-Liner MVP with Cummins ISB Engine			P551103

THOMAS BUILT FUEL/WATER SEPARATOR FILTERS

Table 12-48: Fuel/Water Separator Filters for Thomas Built

OEM Part Number	Manufacturer	Engine Make/Model	Baldwin	Cummins	Donaldson
-----------------	--------------	-------------------	---------	---------	-----------

FUEL/WATER SEPARATOR ELEMENT FILTER - DAVCO 382 SYSTEM

FS19729	Thomas Built	Saf-T-Liner with Caterpillar C7 Engine	PF7755JAB		
FS19729	Thomas Built	Saf-T-Liner with Caterpillar 3126 Engine	PF7755JAB		

FUEL/WATER SEPARATOR FILTER

1808623-C1	Thomas Built	Vista with IHC DT360 Engine	BF7584JAB		
------------	--------------	-----------------------------	-----------	--	--

FUEL/WATER SEPARATOR FILTER - MADE BEFORE 1995, WITH SENSOR PORT

1813104-C91	Thomas Built	Vista with IHC T444E (7.3L) Engine	BF1222SPJAB		
-------------	--------------	------------------------------------	-------------	--	--

FUEL/WATER SEPARATOR FILTER - MADE BEFORE 1995, WITHOUT SENSOR PORT

1813104-C91	Thomas Built	Vista with IHC T444E (7.3L) Engine	BF1222JAB		
-------------	--------------	------------------------------------	-----------	--	--

FUEL/WATER SEPARATOR FILTER, SPIN-ON

R50419	Thomas Built	Saf-T-Liner with Cummins ISB Engine	BF1373SPJAB		
--------	--------------	-------------------------------------	-------------	--	--

OPTIONAL FUEL/WATER SEPARATOR FILTER

S3226T	Thomas Built	Saf-T-Liner with Cummins ISB Engine	BF1347JAB		
--------	--------------	-------------------------------------	-----------	--	--

THOMAS BUILT LUBE/OIL FILTERS

Table 12-49: Lube/Oil Filters for Thomas Built

OEM Part Number	Manufacturer	Engine Make/Model	Baldwin	Cummins	Donaldson
-----------------	--------------	-------------------	---------	---------	-----------

DUAL-FLOW LUBE FILTER

LF9009	Thomas Built	Saf-T-Liner with Cummins ISC Engine	BD7309JAB		
--------	--------------	-------------------------------------	-----------	--	--

FULL-FLOW LUBE FILTER, SPIN-ON

LF3970	Thomas Built	Saf-T-Liner MVP with Cummins ISB Engine			P550428
--------	--------------	---	--	--	---------

LUBE ELEMENT FILTER

RE509672	Thomas Built	Saf-T-Liner with John Deere 6081 8.1L Clear Natural Gas Engine	P7233JAB		
----------	--------------	--	----------	--	--

LUBE FILTER

1808896-C1	Thomas Built	Vista with IHC DT360 Engine	B299JAB		
1811953-C1	Thomas Built	Vista with IHC DT360 Engine	B309JAB		
1819452-C1	Thomas Built	Vista with IHC DT408 Engine	B7030JAB		
1814562-C1	Thomas Built	Vista with IHC T444E (7.3L) Engine	B7039JAB		
LF3970	Thomas Built	Saf-T-Liner with Cummins ISB Engine	B7177JAB		

LUBE FILTER - MADE BEFORE 1994

1808896-C1	Thomas Built	Vista with IHC DT466 Engine	B299JAB		
------------	--------------	-----------------------------	---------	--	--

LUBE FILTER - MADE BEFORE 1995

1811953-C1	Thomas Built	Vista with IHC DT466 Engine	B309JAB		
------------	--------------	-----------------------------	---------	--	--

LUBE FILTER - MADE BEFORE JANUARY 2004

1R0739	Thomas Built	Saf-T-Liner with Caterpillar C7 Engine	B7600JAB		
1R0739	Thomas Built	Saf-T-Liner with Caterpillar 3126 Engine	B7600JAB		

LUBE FILTER - MADE FROM 1994 TO PRESENT

1833121-C1	Thomas Built	Vista with IHC DT466 Engine	B7030JAB		
------------	--------------	-----------------------------	----------	--	--

LUBE FILTER - MADE FROM 2004 TO PRESENT

1R1807	Thomas Built	Saf-T-Liner with Caterpillar 3126 Engine	B7700JAB		
1R1807	Thomas Built	Saf-T-Liner with Caterpillar C7 Engine	B7700JAB		

LUBE FILTER, SPIN-ON

RE57394	Thomas Built	Saf-T-Liner with John Deere 6081 8.1L Clear Natural Gas Engine	BT486JAB		
---------	--------------	--	----------	--	--

THOMAS BUILT STEERING FILTERS

Table 12-50: Steering Filters for Thomas Built

OEM Part Number	Manufacturer	Engine Make/Model	Baldwin	Cummins	Donaldson
STEERING FILTER					
T1808D	Thomas Built	Saf-T-Liner with Cummins ISB Engine	BT9388JAB		
HF6162	Thomas Built	Vista with IHC DT360 Engine	P106HDJAB		
HF6162	Thomas Built	Vista with IHC DT408 Engine	P106HDJAB		
HF6162	Thomas Built	Vista with IHC T444E (7.3L) Engine	P106HDJAB		
HF6162	Thomas Built	Vista with IHC DT466 Engine	P106HDJAB		

THOMAS BUILT TRANSMISSION FILTERS

Table 12-51: Transmission Filters for Thomas Built

OEM Part Number	Manufacturer	Engine Make/Model	Baldwin	Cummins	Donaldson
OPTIONAL TRANSMISSION FILTER, SPIN-ON					
17237	Thomas Built	Saf-T-Liner with Caterpillar C7 Engine	B2JAB		
17237	Thomas Built	Saf-T-Liner with Caterpillar 3126 Engine	B2JAB		
17237	Thomas Built	Saf-T-Liner with Cummins ISB Engine	B2JAB		
17237	Thomas Built	Saf-T-Liner with Cummins ISC Engine	B2JAB		
17237	Thomas Built	Saf-T-Liner with John Deere 6081 8.1L Clear Natural Gas Engine	B2JAB		
TRANSMISSION FILTER - FOR 1000 & 2000 SERIES, SPIN-ON					
29539579	Thomas Built	Saf-T-Liner with Caterpillar C7 Engine	BT8460JAB		
29539579	Thomas Built	Saf-T-Liner with Caterpillar 3126 Engine	BT8460JAB		
29539579	Thomas Built	Saf-T-Liner with Cummins ISB Engine	BT8460JAB		
29539579	Thomas Built	Saf-T-Liner with Cummins ISC Engine	BT8460JAB		
29539579	Thomas Built	Saf-T-Liner with John Deere 6081 8.1L Clear Natural Gas Engine	BT8460JAB		
TRANSMISSION FILTER - FOR AT & MT SERIES, SPIN-ON					
29510922	Thomas Built	Saf-T-Liner with Caterpillar C7 Engine	BT8316MPGJAB		
29510922	Thomas Built	Saf-T-Liner with Caterpillar 3126 Engine	BT8316MPGJAB		
29510922	Thomas Built	Saf-T-Liner with Cummins ISB Engine	BT8316MPGJAB		
29510922	Thomas Built	Saf-T-Liner with Cummins ISC Engine	BT8316MPGJAB		
29510922	Thomas Built	Saf-T-Liner with John Deere 6081 8.1L Clear Natural Gas Engine	BT8316MPGJAB		

OEM Part Number	Manufacturer	Engine Make/Model	Baldwin	Cummins	Donaldson
TRANSMISSION FILTER ELEMENT - 2" KIT, 3000 & 4000 SERIES					
29540493	Thomas Built	Saf-T-Liner with Caterpillar C7 Engine	PT9416MPGK1TJAB		
29540493	Thomas Built	Saf-T-Liner with Caterpillar 3126 Engine	PT9416MPGK1TJAB		
29540493	Thomas Built	Saf-T-Liner with Cummins ISB Engine	PT9416MPGK1TJAB		
29540493	Thomas Built	Saf-T-Liner with Cummins ISC Engine	PT9416MPGK1TJAB		
29540493	Thomas Built	Saf-T-Liner with John Deere 6081 8.1L Clear Natural Gas Engine	PT9416MPGK1TJAB		
TRANSMISSION FILTER ELEMENT - 4" KIT, 3000 & 4000 SERIES					
29540494	Thomas Built	Saf-T-Liner with Caterpillar C7 Engine	PT9415MPGK1TJAB		
29540494	Thomas Built	Saf-T-Liner with Caterpillar 3126 Engine	PT9415MPGK1TJAB		
29540494	Thomas Built	Saf-T-Liner with Cummins ISC Engine	PT9415MPGK1TJAB		
29540494	Thomas Built	Saf-T-Liner with John Deere 6081 8.1L Clear Natural Gas Engine	PT9415MPGK1TJAB		
TRANSMISSION FILTER PAN-TYPE - 3.8" PAN					
29540976	Thomas Built	Vista with IHC T444E (7.3L) Engine		HF28943FLG	
29540976	Thomas Built	Vista with IHC DT466 Engine		HF28943FLG	
29540976	Thomas Built	Vista with IHC DT360 Engine	PT9415MPGK1TJAB		
29540976	Thomas Built	Vista with IHC DT408 Engine	PT9415MPGK1TJAB		
TRANSMISSION FILTER PAN-TYPE - 3.8" PAN, AT SERIES					
29540976	Thomas Built	Saf-T-Liner with Caterpillar C7 Engine	PT9415MPGK1TJAB		
29540976	Thomas Built	Saf-T-Liner with Caterpillar 3126 Engine	PT9415MPGK1TJAB		
29540976	Thomas Built	Saf-T-Liner with Cummins ISB Engine	PT9415MPGK1TJAB		
29540976	Thomas Built	Saf-T-Liner with Cummins ISC Engine	PT9415MPGK1TJAB		
29540976	Thomas Built	Saf-T-Liner with John Deere 6081 8.1L Clear Natural Gas Engine	PT9415MPGK1TJAB		
TRANSMISSION FILTER PAN-TYPE - 5.3" PAN					
29538489	Thomas Built	Vista with IHC DT360 Engine	19739JAB		
29538489	Thomas Built	Vista with IHC DT408 Engine	19739JAB		
29538489	Thomas Built	Vista with IHC T444E (7.3L) Engine	19739JAB		
29538489	Thomas Built	Vista with IHC DT466 Engine	19739JAB		
TRANSMISSION FILTER PAN-TYPE - 5.3" PAN, AT & MT SERIES					
29538489	Thomas Built	Saf-T-Liner with Caterpillar C7 Engine	19739JAB		
29538489	Thomas Built	Saf-T-Liner with Caterpillar 3126 Engine	19739JAB		
29538489	Thomas Built	Saf-T-Liner with Cummins ISB Engine	19739JAB		
29538489	Thomas Built	Saf-T-Liner with Cummins ISC Engine	19739JAB		
29538489	Thomas Built	Saf-T-Liner with John Deere 6081 8.1L Clear Natural Gas Engine	19739JAB		

OEM Part Number	Manufacturer	Engine Make/Model	Baldwin	Cummins	Donaldson
-----------------	--------------	-------------------	---------	---------	-----------

TRANSMISSION FILTER PAN-TYPE - DEEP PAN WITH GASKET, 1000 & 2000 SERIES

29537966	Thomas Built	Saf-T-Liner with Caterpillar C7 Engine	20017JAB		
29537966	Thomas Built	Saf-T-Liner with Caterpillar 3126 Engine	20017JAB		
29537966	Thomas Built	Saf-T-Liner with Cummins ISB Engine	20017JAB		
29537966	Thomas Built	Saf-T-Liner with Cummins ISC Engine	20017JAB		
29537966	Thomas Built	Saf-T-Liner with John Deere 6081 8.1L Clear Natural Gas Engine	20017JAB		

TRANSMISSION FILTER PAN-TYPE - DEEP PAN WITHOUT GASKET, 1000 & 2000 SERIES

29537966	Thomas Built	Saf-T-Liner with Caterpillar C7 Engine	20003JAB		
29537966	Thomas Built	Saf-T-Liner with Caterpillar 3126 Engine	20003JAB		
29537966	Thomas Built	Saf-T-Liner with Cummins ISB Engine	20003JAB		
29537966	Thomas Built	Saf-T-Liner with Cummins ISC Engine	20003JAB		
29537966	Thomas Built	Saf-T-Liner with John Deere 6081 8.1L Clear Natural Gas Engine	20003JAB		

TRANSMISSION FILTER PAN-TYPE - SHALLOW PAN WITH GASKET, 1000 & 2000 SERIES

29537965	Thomas Built	Saf-T-Liner with Caterpillar C7 Engine	20016JAB		
29537965	Thomas Built	Saf-T-Liner with Caterpillar 3126 Engine	20016JAB		
29537965	Thomas Built	Saf-T-Liner with Cummins ISB Engine	20016JAB		
29537965	Thomas Built	Saf-T-Liner with Cummins ISC Engine	20016JAB		
29537965	Thomas Built	Saf-T-Liner with John Deere 6081 8.1L Clear Natural Gas Engine	20016JAB		

TRANSMISSION FILTER PAN-TYPE - SHALLOW PAN WITHOUT GASKET, 1000 & 2000 SERIES

29537965	Thomas Built	Saf-T-Liner with Caterpillar C7 Engine	20004JAB		
29537965	Thomas Built	Saf-T-Liner with Caterpillar 3126 Engine	20004JAB		
29537965	Thomas Built	Saf-T-Liner with Cummins ISB Engine	20004JAB		
29537965	Thomas Built	Saf-T-Liner with Cummins ISC Engine	20004JAB		
29537965	Thomas Built	Saf-T-Liner with John Deere 6081 8.1L Clear Natural Gas Engine	20004JAB		

TRANSMISSION FILTER, SPIN-ON

4304827	Thomas Built	Saf-T-Liner with Caterpillar C7 Engine	BT223JAB		
4304827	Thomas Built	Saf-T-Liner with Caterpillar 3126 Engine	BT223JAB		
4304827	Thomas Built	Saf-T-Liner with Cummins ISB Engine	BT223JAB		
4304827	Thomas Built	Saf-T-Liner with Cummins ISC Engine	BT223JAB		
4304827	Thomas Built	Saf-T-Liner with John Deere 6081 8.1L Clear Natural Gas Engine	BT223JAB		
29510922	Thomas Built	Vista with IHC DT360 Engine	BT8316MPGJAB		
29510922	Thomas Built	Vista with IHC DT408 Engine	BT8316MPGJAB		
29510922	Thomas Built	Vista with IHC T444E (7.3L) Engine	BT8316MPGJAB		
29510922	Thomas Built	Vista with IHC DT466 Engine	BT8316MPGJAB		

VAN HOOL

VAN HOOL AIR FILTERS

Table 12-52: Air Filters for Van Hool

OEM Part Number	Manufacturer	Engine Make/Model	Baldwin	Fleetguard	Donaldson
-----------------	--------------	-------------------	---------	------------	-----------

PRIMARY AIR FILTER

1146384	Van Hool	AG300 with DAF PE228C Engine		AF26214FLG	
1146384	Van Hool	AG300 with DAF PE265C Engine		AF26214FLG	
1146384	Van Hool	ASTROMEGA TD927 with DAF XE355C Engine		AF26214FLG	

SECONDARY AIR FILTER, MAGNUM RS

1147590	Van Hool	ASTROMEGA TD927 with DAF XE355C Engine		AF26215FLG	
---------	----------	--	--	------------	--

VAN HOOL AIR/OIL SEPARATOR FILTERS

Table 12-53: Air/Oil Separator Filters for Van Hool

OEM Part Number	Manufacturer	Engine Make/Model	Baldwin	Fleetguard	Donaldson
-----------------	--------------	-------------------	---------	------------	-----------

AIR/OIL SEPARATOR FILTER

1686587	Van Hool	A330, A360, AG300 with DAF PR265 Engine		AS2474FLG	
1686587	Van Hool	ALICRON T916, CL916, T916, TL916 with DAF MX300S Engine		AS2474FLG	
1686587	Van Hool	ASTROMEGA TD925, TD295 with DAF MX375S Engine		AS2474FLG	
1686587	Van Hool	CL915, CL916, TD925 with DAF MX340 Engine		AS2474FLG	
4931691	Van Hool	A309 with Cummins ISBE225 Engine		AS2474FLG	
n/a	Van Hool	A330 with DAF PR228 Engine		AS2474FLG AF55711FLG	
n/a	Van Hool	A360 with DAF PR183 Engine		AS2474FLG AF55711FLG	
n/a	Van Hool	A360 with DAF PR228 Engine		AS2474FLG AF55711FLG	
n/a	Van Hool	AG300 with DAF PR183 Engine		AS2474FLG AF55711FLG	

VAN HOOL FUEL FILTERS

Table 12-54: Fuel Filters for Van Hool

OEM Part Number	Manufacturer	Engine Make/Model	Baldwin	Cummins	Donaldson
FUEL FILTER					
649425	Van Hool	ALICRON T916 with DAF MX300S Engine		3967874FLG	
649425	Van Hool	ASTROMEGA TD925 with DAF MX375S Engine		3967874FLG	
4897833	Van Hool	A309 with Cummins ISBE225 Engine		FF5485FLG	
1450184	Van Hool	AG300 with DAF PE228C Engine		FF5635FLG	
1450184	Van Hool	AG300 with DAF PE265C Engine		FF5635FLG	
1450184	Van Hool	ASTROMEGA TD927 with DAF XE355C Engine		FF5635FLG	
1811391	Van Hool	A330, A360, AG300 with DAF PR183 Engine		FF5635FLG	
1811391	Van Hool	A330, A360, AG300 with DAF PR228 Engine		FF5635FLG	
1811391	Van Hool	A330, A360, AG300 with DAF PR265 Engine		FF5635FLG	

FUEL FILTER, CARTRIDGE

n/a	Van Hool	ALIZEE 815 with DAF Engine		FF147FLG FF4070FLG WF2053FLG LF4054FLG HF6161FLG	
1397766	Van Hool	AG300 with DAF PE228C Engine		FF5510FLG	
1397766	Van Hool	AG300 with DAF PE265C Engine		FF5510FLG	
1616361	Van Hool	CL915, CL916, TD925 with DAF MX340 Engine		FF5695FLG	
1616361	Van Hool	CL916, T916, TL916 with DAF MX300S Engine		FF5695FLG	
1616361	Van Hool	TD925 with DAF MX375S Engine		FF5695FLG	
1699168	Van Hool	ALICRON T916 with DAF MX300S Engine		FF5695FLG	
1699168	Van Hool	ASTROMEGA TD925 with DAF MX375S Engine		FF5695FLG	

FUEL FILTER, SPIN-ON

No OEM number available	Van Hool	A300L with Cummins LT10 Engine		FF105FLG LF670FLG LF777FLG FS1242FLG WF2071FLG	
No OEM number available	Van Hool	A300L with DAF NS156G Engine		FF4070FLG	
No OEM number available	Van Hool	ASTROMEGA TD824 with DAF DKX1160ATI Engine		FF4070FLG LF4054FLG	
No OEM number available	Van Hool	EOS100 with DAF DKX1160ATI Engine		FF4070FLG LF4054FLG	

FUEL FILTER, USER-FRIENDLY VERSION

No OEM number available	Van Hool	A508 with Cummins 6BT 5.9L Engine		FF42000FLG LF3349FLG FF5052FLG	
-------------------------	----------	-----------------------------------	--	--------------------------------------	--

VAN HOOL FUEL/WATER SEPARATOR FILTERS

Table 12-55: Fuel/Water Separator Filters for Van Hool

OEM Part Number	Manufacturer	Engine Make/Model	Baldwin	Cummins	Donaldson
FUEL/WATER SEPARATOR FILTER, SPIN-ON					
1433649	Van Hool	ALICRON T916, CL916, T916, TL916 with DAF MX300S Engine		FS19769FLG	
1433649	Van Hool	ASTROMEGA TD925, TD925 with DAF MX375S Engine		FS19769FLG	
1433649	Van Hool	CL915, CL916, TD925 with DAF MX340 Engine		FS19769FLG	

VAN HOOL HYDRAULIC FILTERS

Table 12-56: Hydraulic Filters for Van Hool

OEM Part Number	Manufacturer	Engine Make/Model	Baldwin	Cummins	Donaldson
HYDRAULIC FILTER, CARTRIDGE					
229348	Van Hool	A330, A360, AG300 with DAF PR183 Engine	HF6162JAB	HF6162FLG	
229348	Van Hool	A330, A360, AG300 with DAF PR228 Engine	HF6162JAB	HF6162FLG	
229348	Van Hool	A330, A360, AG300 with DAF PR265 Engine	HF6162JAB	HF6162FLG	
229348	Van Hool	CL915, CL916, TD925 with DAF MX340 Engine		HF6162FLG	
229348	Van Hool	ALICRON T916, CL916, T916, TL916 with DAF MX300S Engine		HF6162FLG	
229348	Van Hool	ASTROMEGA TD925, TD925 with DAF MX375S Engine		HF6162FLG	
229348	Van Hool	ASTROMEGA TD927 with DAF XE355C Engine		HF6162FLG	

VAN HOOL LUBE/OIL FILTERS

Table 12-57: Lube/Oil Filters for Van Hool

OEM Part Number	Manufacturer	Engine Make/Model	Baldwin	Cummins	Donaldson
LUBE CENTRIFUGAL BY-PASS FILTER					
1376481	Van Hool	A330, A360, AG300 with DAF PR183 Engine		CS41001FLG	
1376481	Van Hool	A330, A360, AG300 with DAF PR228 Engine		CS41001FLG	
1376481	Van Hool	A330, A360, AG300 with DAF PR265 Engine		CS41001FLG	
1376481	Van Hool	AG300 with DAF PE228C Engine		CS41001FLG	

OEM Part Number	Manufacturer	Engine Make/Model	Baldwin	Cummins	Donaldson
1376481	Van Hool	AG300 with DAF PE265C Engine		CS41001FLG	
1376481	Van Hool	ASTROMEGA TD927 with DAF XE355C Engine		CS41001FLG	
1643072	Van Hool	ALICRON T916, CL916, T916, TL916 with DAF MX300S Engine		CS41008FLG	
1643072	Van Hool	ASTROMEGA TD925, TD925 with DAF MX375S Engine		CS41008FLG	
1643072	Van Hool	CL915, CL916, TD925 with DAF MX340 Engine		CS41008FLG	

LUBE FILTER

4897898	Van Hool	A309 with Cummins ISBE225 Engine		LF16015FLG	
1397764	Van Hool	AG300 with DAF PE228C Engine		LF16042FLG	
1397764	Van Hool	AG300 with DAF PE265C Engine		LF16042FLG	
1629393	Van Hool	CL915, CL916, TD925 with DAF MX340 Engine		LF16233FLG	
1629393	Van Hool	CL916, T916, TL916 with DAF MX300S Engine		LF16233FLG	
1629393	Van Hool	ASTROMEGA TD925, TD925 with DAF MX375S Engine		LF16233FLG	

LUBE FILTER, CARTRIDGE

1397765	Van Hool	A330, A360, AG300 with DAF PR183 Engine		LF16232FLG	
1397765	Van Hool	A330, A360, AG300 with DAF PR228 Engine		LF16232FLG	
1397765	Van Hool	A330, A360, AG300 with DAF PR265 Engine		LF16232FLG	
1397765	Van Hool	AG300 with DAF PE228C Engine		LF16232FLG	
1397765	Van Hool	AG300 with DAF PE265C Engine		LF16232FLG	
1643070	Van Hool	ALICRON T916 with DAF MX300S Engine		LF16233FLG	
1397765	Van Hool	ASTROMEGA TD927 with DAF XE355C Engine		LF16232FLG	

LUBE FILTER, SPIN-ON

n/a	Van Hool	ACRON T815 with DAF DKX1160ATI Engine		LF4054FLG FF4070FLG	
n/a	Van Hool	ACRON with DAF Engine		LF4054FLG FF4070FLG FF147FLG HF6161FLG WF2053FLG	

VAN HOOL STEERING FILTERS

Table 12-58: Steering Filters for Van Hool

OEM Part Number	Manufacturer	Engine Make/Model	Baldwin	Cummins	Donaldson
229348	Van Hool	AG300 with DAF PE228C Engine	HF6162JAB		
229348	Van Hool	AG300 with DAF PE265C Engine	HF6162JAB		

VAN HOOL WATER FILTERS

Table 12-59: Water Filters for Van Hool

OEM Part Number	Manufacturer	Engine Make/Model	Baldwin	Cummins	Donaldson
n/a	Van Hool	ALIZEE 760 with DAF Engine		WF2053FLG FF4070FLG FF147FLG HF6161FLG LF4054FLG	



*For information, updates, or corrections,
please contact us at TRPBus@TRPParts.com*

*No part of this marketing material may be
reproduced in any manner without written
permission from TRP® North America.*

TRP North America

750 Houser Way N.
Renton, WA 98057

www.trpparts.com



Parts for all brands of buses.



13

BUS PARTS

FLUIDS

*Proven, reliable and
always innovative.*

TRP® offers reliable aftermarket products that are designed and tested to exceed customers' expectations regardless of the bus make, model or age.



CHASSIS GREASE • COOLANT •
OILS • WIPER FLUID



BUS PARTS

Tested. Reliable. Guaranteed.

Fluids

Choosing the right replacement part or service for your vehicle—whether you own one, or a fleet—is one of the most important decisions you can make for your business. And, with tested TRP® parts it's an easy decision.

Regardless of the make you drive, TRP® quality replacement parts are engineered to fit your truck, trailer or bus. Choose the parts that give you the best value for your business. Check them out at an approved TRP® retailer near you.

The cross reference information in this catalog is based upon data provided by several industry sources and our partners. While every attempt is made to ensure the information presented is accurate, we bear no liability due to incorrect or incomplete information.

Product Availability

Due to export restrictions and market demands, not all products are always available in every location. Check for availability in your area with your local TRP® Distributor.

No part of this marketing material may be reproduced in any manner without written permission from TRP® North America.

CONTENTS

CLEANBLUE® DIESEL EXHAUST FLUID

CleanBlue® Products 13-4

ENGINE COOLANT

TRP® Coolant Labeled For U.S. & Mexico 13-5

Coolant – U.S. & Mexico 13-5

TRP® Coolant Labeled For Canada 13-6

TRP® Coolant Labeled For Canada 13-6

Shell Engine Coolant Labeled For U.S. 13-7

Shell Rotella Labeled For U.S. 13-7

Shell Shellzone Labeled For U.S. 13-7

ENGINE OIL

Chevron Heavy Duty Engine Oil 13-8

Chevron DELO Engine Oil 13-8

Shell Heavy Duty Engine Oil Labeled For U.S. 13-8

Shell Rotella Labeled For U.S. 13-8

TRP® North America

750 Houser Way N.
Renton, WA 98057

www.trpparts.com

TRANSMISSION FLUID

Chevron Transmission Fluid 13-9

Chevron RPM Synthetic Transmission Fluid 13-9

Chevron DELO Synthetic Transmission Fluid 13-9

Chevron Automatic Transmission Fluid Medium Duty-3 13-9

Chevron Automatic Transmission Fluid DEXRON VI 13-9

Chevron Synthetic Automatic Transmission Fluid Heavy Duty 13-9

Delvac Transmission Fluid 13-10

Shell Spirax - For U.S. 13-10

Shell Spirax - For Canada 13-10

CHASSIS GREASE

Chevron Chassis Grease 13-11

Chevron DELO Chassis Grease 13-11

Shell Chassis Grease Labeled For U.S. 13-11

Shell Retinax Labeled For U.S. 13-11

AXLE/GEAR OIL

Shell Axle/Gear Oil Labeled For U.S. & Canada 13-12

Shell Spirax Labeled For Canada 13-12

Shell Spirax Labeled For U.S. 13-12

WIPER FLUID

Wiper Fluid 13-13

Windshield Wiper Fluid 13-13

CLEANBLUE® DIESEL EXHAUST FLUID



CB0025



CB0025, CB3300, CB0550

CLEANBLUE® PRODUCTS

Table 13-1: CleanBlue® Products

Part Number	Container Size
CB0025	2.5 Gallon Jug
CB0550	55 Gallon Drum
CB2750	275 Gallon Tote (Disposable)
CB3300	330 Gallon Tote

ENGINE COOLANT

For Radiators See pg. 7-5. 



EC3501



HC3101

TRP® COOLANT LABELED FOR U.S. & MEXICO

Table 13-2: TRP® Coolant for U.S. & Mexico

Part Number	Description
COOLANT – U.S. & MEXICO	
EC3501	Extended Life 50/50 Jug
EC3555	Extended Life 50/50 Drum
EC3101	Extended Life Concentrate Jug
EC3155	Extended Life Concentrate Drum
HC3501	Heavy Duty 50/50 Jug
HC3555	Heavy Duty 50/50 Drum
HC3101	Heavy Duty Concentrate Jug
HC3155	Heavy Duty Concentrate Drum
CC3101	Conventional Concentrate Jug
CC3155	Conventional Concentrate Drum

TRP® COOLANT LABELED FOR CANADA



EC7501



HC7101

Table 13-3: TRP® Coolant Labeled For Canadian

Part Number	Description
TRP® COOLANT LABELED FOR CANADA	
EC7501	Extended Life 50/50 Jug
EC7555	Extended Life 50/50 Drum
EC7101	Extended Life Concentrate Jug
EC7155	Extended Life Concentrate Drum
HC7501	Heavy Duty 50/50 Jug
HC7555	Heavy Duty 50/50 Drum
HC7101	Heavy Duty Concentrate Jug
HC7155	Heavy Duty Concentrate Drum
CC7101	Conventional Concentrate Jug
CC7155	Conventional Concentrate Drum

SHELL ENGINE COOLANT LABELED FOR U.S.



9404206021

Table 13-4: Shell Engine Coolant for U.S.

Part Number	Description	Unit of Measure
SHELL ROTELLA LABELED FOR U.S.		
9404206021	Shell Rotella Pre-Diluted, Extended Life Engine Coolant (1 Case - 6 one gallon jugs/ case)	Case
SHELL SHELLZONE LABELED FOR U.S.		
9401006021	Shell Shellzone Concentrate, Conventional Engine Coolant (1 Case - 6 one gallon jugs/ case)	Case
9401000055	Shell Shellzone Concentrate, Conventional Engine Coolant (55 gallon drum)	Drum
9406706021	Shell Shellzone AntiFreeze/Coolant Pre-Diluted, Conventional Engine Coolant (1 Case - 6 one gallon jugs/ case)	Case
550022522	Shell Rotella Pre-Diluted, Extended Life Engine Coolant (55 gallon drum)	Drum

Information & Images Provided by Shell

ENGINE OIL**CHEVRON HEAVY DUTY ENGINE OIL**

For Engine Kits See pg. 7-24.



Check the owner's manual for correct application of Chevron products. Chevron Lubtek is also available for assistance by email: lubetek@chevron.com or by phone: 800-582-3835 (800-LUBETEK)

Table 13-5: Chevron Heavy Duty Engine Oil

Part Number	Description	Canadian Part Number	Unit of Measure
CHEVRON DELO ENGINE OIL			
222220-351	Chevron DELO 400 Engine Oil 15W-40 LE CJ4 (12 bottles per case, 1 qt/ 946 ml each bottle)	222220-732C	Case
222220-448	Chevron DELO 400 Engine Oil LE CJ4 15W-40 (5 gal/ 18.9 L Pail)	222220-448C	Pail
222220-462	Chevron DELO Engine Oil 400 LE 15W-40 SAE (3 x 1 gal/ 3.78 L Jugs)	222220-389C	Case

Information & Images Provided by Chevron

SHELL HEAVY DUTY ENGINE OIL LABELED FOR U.S.

Table 13-6: Shell Heavy Duty Engine Oil for U.S.

Part Number	Description	Unit of Measure
SHELL ROTELLA LABELED FOR U.S.		
500004741	Shell Rotella T Triple Protection 15W40 CJ4 Engine Oil (Bulk)	Bulk Gallons
550019913	Shell Rotella T Triple Protection 15W40 CJ4 (1 Case - 3 one gallon jugs/ case)	Case
550019918	Shell Rotella T Triple Protection 15W40 CJ4 (55 gallon drum)	Drum
550019916	Shell Rotella T Triple Protection 15W40 CJ4 (5 gallon pail)	Pail

Information & Images Provided by Shell

TRANSMISSION FLUID**CHEVRON TRANSMISSION FLUID**

For Transmissions See pg. 11-3.



Check the owner's manual for correct application of Chevron products. Chevron Lubtek is also available for assistance by email: lubetek@chevron.com or by phone: 800-582-3835 (800-LUBETEK)

Table 13-7: Chevron Transmission Fluid

Part Number	Description	Canadian Part Number	Unit of Measure
CHEVRON RPM SYNTHETIC TRANSMISSION FLUID			
210456-783	Chevron RPM Synthetic Transmission Fluid SAE50 (35 lb./ 15.9 Kg Pail)	210456783	Pail
210456-873	Chevron RPM Synthetic Transmission Fluid SAE50 (120 lb./ 54.4 Kg Keg)	210456-873C	Keg
210456-983	Chevron RPM Synthetic Transmission Fluid SAE50 (55 gal/ 181 Kg Drum)	210456-983C	Drum
210456-985	Chevron RPM Synthetic Transmission Fluid SAE50 (Bulk)	Not Available in Canada	Bulk Gallons/ Litres

CHEVRON DELO SYNTHETIC TRANSMISSION FLUID

221225-319	Chevron DELO Synthetic Transmission Fluid SAE50 (12 bottles per case, 1.8 lb. per bottle)	Not Available in Canada	Case
221225-361	Chevron DELO Synthetic Transmission Fluid SAE50 (33 lb./ 14.9 Kg Pail)	221225-361C	Pail
221225-870	Chevron DELO Synthetic Transmission Fluid SAE50 (110 lb./ 49.9 Kg keg)	221225-870C	Keg
221225-953	Chevron DELO Synthetic Transmission Fluid SAE50 (375 lb./ 170.1 Kg Drum)	221225-953C	Drum

CHEVRON AUTOMATIC TRANSMISSION FLUID MEDIUM DUTY-3

226502-448	Chevron ATF MD-3 (5 gal/ 18.9 L Pail)	226502-448C	Pail
226502-560	Chevron ATF MD-3 (16 gal/ 60.5 L Keg)	226502-560C	Keg
226502-721	Chevron ATF MD-3 (12 bottles per case, 1 qt/ 946 ml each bottle)	226502-732C	Case
226502-981	Chevron ATF MD-3 (55 gal/ 208 L Drum)	226502-981C	Drum
226502-990	Chevron ATF MD-3 (Bulk)	226502-990C	Bulk Gallons/ Litres

CHEVRON AUTOMATIC TRANSMISSION FLUID DEXRON VI

226532-351	Chevron ATF DEXRON VI (12 bottles per case, 1 qt/ 946 ml each bottle)	226532-732C	Case
226532-981	Chevron ATF DEXRON VI (55 gal/ 208 L Drum)	226532-981C	Drum

CHEVRON SYNTHETIC AUTOMATIC TRANSMISSION FLUID HEAVY DUTY

226718-448	Chevron Synthetic ATF Heavy Duty (5 gal/ 18.9 L Pail)	226718-448C	Pail
226718-981	Chevron Synthetic ATF Heavy Duty (55 gal/ 208 L Drum)	226718-981C	Drum

Information & Images Provided by Chevron

DELVAC TRANSMISSION FLUID



Table 13-8: Delvac Synthetic Automatic Transmission Fluid

Part Number	Description
98KH08	Mobil Delvac Synthetic ATF 4 x 1 Gallon / 4 x 3.78 Liter
98HF30	Mobil Delvac Synthetic ATF 55 Gallon Drum / 208.1 Liter Drum
98HF29	Mobil Delvac Synthetic ATF 5 Gallon Pail / 18.9 Liter Pail
98HF28	Mobil Delvac Synthetic ATF Bulk Part ID per Gallon
005978851M0	Mobil Delvac Synthetic ATF - 20 Pack of 1 Liter containers, Product of Canada

SHELL TRANSMISSION FLUID LABELED FOR U.S. & CANADA



Table 13-9: Shell Transmission Fluid for U.S. & Canada

Part Number	Description	Unit of Measure
SHELL SPIRAX - FOR U.S.		
550022333	Shell Spirax ASX-R 75W-90 Transmission Fluid (120lb keg)	Keg
5070736	Shell Spirax GSX 50 weight Synthetic Manual Transmission Fluid (33lb 5 gallon pail)	Pail
5070739	Shell Spirax GSX 50 weight Synthetic Manual Transmission Fluid (375 lb 55 gallon drum)	Drum

SHELL SPIRAX - FOR CANADA

43705030	Shell Spirax GSX 50 weight Synthetic Manual Transmission Fluid - For Canada	Drum
43705045	Shell Spirax GSX 50 weight Synthetic Manual Transmission Fluid - For Canada	Bulk Litres

Information & Images Provided by Shell

CHASSIS GREASE

Check the owner's manual for correct application of Chevron products. Chevron Lubtek is also available for assistance by email: lubetek@chevron.com or by phone: 800-582-3835 (800-LUBETEK)

CHEVRON CHASSIS GREASE



Table 13-10: Chevron Chassis Grease

Part Number	Description	Canadian Part Number	Unit of Measure
CHEVRON DELO CHASSIS GREASE			
235208-451	Chevron DELO Grease EP NLGI 2 (35 lb./ 15.9 Kg Pail)	235208-451C	Pail
235208-642	Chevron DELO Grease EP NLGI 2 (4 x 10 tubes - 14 oz./ 397 g each)	235208-642C	Case
235208-643	Chevron DELO Grease EP NLGI 2 (10 x 14 oz. tubes)	Not Available in Canada	Case
235208-873	Chevron DELO Grease EP NLGI 2 (120 lb./ 54.4 Kg Keg)	235208-873C	Keg
235208-980	Chevron DELO Grease EP NLGI 2 (55 gal/ 181 Kg Drum)	235208-980C	Drum

Information & Images Provided by Chevron

SHELL CHASSIS GREASE LABELED FOR U.S.



Table 13-11: Shell Chassis Grease

Part Number	Description	Unit of Measure
SHELL RETINAX LABELED FOR U.S.		
5067708	Shell Retinax LX #2 Chassis Grease (120lb 16 gallon keg)	Keg
5067715	Shell Retinax LX #2 Chassis Grease (400lb drum)	Drum

Information & Images Provided by Shell

AXLE/GEAR OIL

SHELL AXLE/GEAR OIL LABELED FOR U.S. & CANADA

Table 13-12: Shell Axle/Gear Oil

Part Number	Description	Unit of Measure
SHELL SPIRAX LABELED FOR U.S.		
550022332	Shell Spirax ASX-R 75W-90 Synthetic Axle/ Gear Oil (35 gallon pail)	Pail
550022334	Shell Spirax ASX-R 75W-90 Synthetic Axle/ Gear Oil (400lb 55 gallon drum)	Drum


SHELL SPIRAX LABELED FOR CANADA

550022334	Shell Spirax ASX-R 75W-90 Synthetic Axle/ Gear Oil - For Canada	Drum
-----------	---	------

Information Provided by Shell

WIPER FLUID

For Windshields See pg. 19-4.



WIPER FLUID



DE1



M506RSS



M516

Table 13-13: Wiper Fluid

Part Number	Description
WINDSHIELD WIPER FLUID	
DE1	Windshield De-Icer - 12oz. Bottle
M506RSS	Windshield Washer Solvent - 6oz.
M516	Windshield Wash/Antifreeze Concentrate/Ammonia - 16 oz

Information & Images Provided by Radiator Specialties



*For information, updates, or corrections,
please contact us at TRPBus@TRPParts.com*

*No part of this marketing material may be
reproduced in any manner without written
permission from TRP® North America.*

TRP® North America

750 Houser Way N.
Renton, WA 98057

www.trpparts.com



Parts for all brands of buses.



14

BUS PARTS

SEATS

*Proven, reliable and
always innovative.*

TRP® offers reliable aftermarket products that are designed and tested to exceed customers' expectations regardless of the bus make, model or age.



SEATS • SEAT COVERS



BUS PARTS

Tested. Reliable. Guaranteed.

Seats

Choosing the right replacement part or service for your vehicle—whether you own one, or a fleet—is one of the most important decisions you can make for your business. And, with tested TRP® parts it's an easy decision.

Regardless of the make you drive, TRP® quality replacement parts are engineered to fit your truck, trailer or bus. Choose the parts that give you the best value for your business. Check them out at an approved TRP® retailer near you.

The cross reference information in this catalog is based upon data provided by several industry sources and our partners. While every attempt is made to ensure the information presented is accurate, we can bear no liability due to incorrect or incomplete information.

Product Availability

Due to border issues and market demands, not all products are always available in every location. Check for availability in your area with your local TRP® Distributor.

No part of this marketing material may be reproduced in any manner without written permission from TRP North America.

CONTENTS

BUS DRIVER SEATS

Bus Chief.	14-4
All-Make Fit - No Arms.	14-4
All-Make Fit - Both Arms	14-4
Magnum 100 - Air Suspension	14-5
Bluebird & Carpenter - No Arms	14-5
Bluebird & Carpenter - Right Arm Only	14-5
Bluebird & Carpenter - Both Arms	14-6
International/IC Bus (Before March 2004) & Thomas Built - No Arms	14-6
International/IC Bus (Before March 2004) & Thomas Built - Right Arm Only.	14-7
International/IC Bus (Before March 2004) & Thomas Built - Both Arms	14-7
International/IC Bus (After March 2004) - No Arms	14-8
International/IC Bus (After March 2004) - Right Arm Only.	14-8
International/IC Bus (After March 2004) - Both Arms	14-9
Magnum 200 - Mechanical Suspension	14-10
Bluebird & Carpenter - No Arms	14-10
Bluebird & Carpenter - Right Arm Only	14-10
Bluebird & Carpenter - Both Arms	14-11

TRP North America

750 Houser Way N.
Renton, WA 98057

www.trpparts.com

International/IC Bus (Before March 2004) & Thomas Built - No Arms.	14-11
International/IC Bus (Before March 2004) & Thomas Built - Right Arm Only	14-12
International/IC Bus (Before March 2004) & Thomas Built - Both Arms	14-12
International/IC Bus (After March 2004) - No Arms	14-13
International/IC Bus (After March 2004) - Right Arm Only.	14-13
International/IC Bus (After March 2004) - Both Arms	14-14
Seat Covers	14-15
Coveralls – Highback.	14-15

BUS DRIVER SEATS

BUS CHIEF

- Knoedler/Kenworth Bus Chief Seat
- Heavy Duty Suspension; Dual shocks
- Protective Rubber Bellow
- 1/2" memory foam layer on seat cushion
- Air Lumbar Support
- Headrest (Adjustable in Height)
- Covered in Matrix Textile



Table 14-1: Driver's Seats - All Make Fit

Part Number	Description	Material	Color
98BC-S72MH-T31	Knoedler/ Kenworth Mid-Back with Adjustable Head-Rest, 6" Height Adjustment, No Arms, Matrix Textile, No Compressor, Black	Heavy Duty, Breathable Matrix Textile	Black
98BS-S72MH-T31	Knoedler/ Kenworth Mid-Back with Adjustable Head-Rest, 6" Height Adjustment, No Arms, Matrix Textile, 12V Integrated Air Compressor, Black	Heavy Duty, Breathable Matrix Textile	Black
98BC-S72MH-T33	Knoedler/ Kenworth Mid-Back with Adjustable Head-Rest, 6" Height Adjustment, No Arms, Matrix Textile, No Compressor, Gray	Heavy Duty, Breathable Matrix Textile	Gray
98BS-S72MH-T33	Knoedler/ Kenworth Mid-Back with Adjustable Head-Rest, 6" Height Adjustment, No Arms, Matrix Textile, 12V Integrated Air Compressor, Gray	Heavy Duty, Breathable Matrix Textile	Gray
98BC-S72MH-T32	Knoedler/ Kenworth Mid-Back with Adjustable Head-Rest, 6" Height Adjustment, No Arms, Matrix Textile, No Compressor, Red	Heavy Duty, Breathable Matrix Textile	Red
98BS-S72MH-T32	Knoedler/ Kenworth Mid-Back with Adjustable Head-Rest, 6" Height Adjustment, No Arms, Matrix Textile, 12V Integrated Air Compressor, Red	Heavy Duty, Breathable Matrix Textile	Red

ALL-MAKE FIT - BOTH ARMS

98BC-S82MH-T31	Knoedler/ Kenworth Mid-Back with Adjustable Head-Rest, 6" Height Adjustment, Both Arms, Matrix Textile, No Compressor, Black	Heavy Duty, Breathable Matrix Textile	Black
98BS-S82MH-T31	Knoedler/ Kenworth Mid-Back with Adjustable Head-Rest, 6" Height Adjustment, Both Arms, Matrix Textile, 12V Integrated Air Compressor, Black	Heavy Duty, Breathable Matrix Textile	Black
98BC-S82MH-T33	Knoedler/ Kenworth Mid-Back with Adjustable Head-Rest, 6" Height Adjustment, Both Arms, Matrix Textile, No Compressor, Gray	Heavy Duty, Breathable Matrix Textile	Gray
98BS-S82MH-T33	Knoedler/ Kenworth Mid-Back with Adjustable Head-Rest, 6" Height Adjustment, Both Arms, Matrix Textile, 12V Integrated Air Compressor, Gray	Heavy Duty, Breathable Matrix Textile	Gray
98BC-S82MH-T32	Knoedler/ Kenworth Mid-Back with Adjustable Head-Rest, 6" Height Adjustment, Both Arms, Matrix Textile, No Compressor, Red	Heavy Duty, Breathable Matrix Textile	Red
98BS-S82MH-T32	Knoedler/ Kenworth Mid-Back with Adjustable Head-Rest, 6" Height Adjustment, Both Arms, Matrix Textile, 12V Integrated Air Compressor, Red	Heavy Duty, Breathable Matrix Textile	Red

Information & Images Provided by Knoedler

MAGNUM 100 - AIR SUSPENSION

- Seats Inc. Magnum School bus Driver Seats
- FMV 222 Certified
- Highback
- Knee-Action Suspension
- 2-way adjusting mechanical lumbar
- 15° recline
- 6" Double-Locking Tracks
- Risers match Bus Types as listed below



Table 14-2: Driver's Seats - Bluebird & Carpenter

Part Number	Description	Material	Color
176566ZN45	Magnum 100 - Air Suspension - Bluebird & Carpenter - 5" Riser, No Arms, PREVAIL®, Black	PREVAIL®	Black
176566ZN47	Magnum 100 - Air Suspension - Bluebird & Carpenter - 5" Riser, No Arms, PREVAIL®, Brown	PREVAIL®	Brown
176566ZN94	Magnum 100 - Air Suspension - Bluebird & Carpenter - 5" Riser, No Arms, PREVAIL®, Gray	PREVAIL®	Gray
176566ZN48	Magnum 100 - Air Suspension - Bluebird & Carpenter - 5" Riser, No Arms, PREVAIL®, Green	PREVAIL®	Green
176566FN31	Magnum 100 - Air Suspension - Bluebird & Carpenter - 5" Riser, No Arms, TUFF-TEX™, Black	TUFF-TEX™	Black
176566FN33	Magnum 100 - Air Suspension - Bluebird & Carpenter - 5" Riser, No Arms, TUFF-TEX™, Brown	TUFF-TEX™	Brown
176566FN35	Magnum 100 - Air Suspension - Bluebird & Carpenter - 5" Riser, No Arms, TUFF-TEX™, Gray	TUFF-TEX™	Gray
176566DN87	Magnum 100 - Air Suspension - Bluebird & Carpenter - 5" Riser, No Arms, PREVAIL®/Cloth, Black	PREVAIL®/Cloth	Black
176566DN86	Magnum 100 - Air Suspension - Bluebird & Carpenter - 5" Riser, No Arms, PREVAIL®/Cloth, Brown	PREVAIL®/Cloth	Brown
176566DN85	Magnum 100 - Air Suspension - Bluebird & Carpenter - 5" Riser, No Arms, PREVAIL®/Cloth, Gray	PREVAIL®/Cloth	Gray

BLUEBIRD & CARPENTER - RIGHT ARM ONLY

176566ZR45	Magnum 100 - Air Suspension - Bluebird & Carpenter - 5" Riser, Right Arm Only, PREVAIL®, Black	PREVAIL®	Black
176566ZR47	Magnum 100 - Air Suspension - Bluebird & Carpenter - 5" Riser, Right Arm Only, PREVAIL®, Brown	PREVAIL®	Brown
176566ZR94	Magnum 100 - Air Suspension - Bluebird & Carpenter - 5" Riser, Right Arm Only, PREVAIL®, Gray	PREVAIL®	Gray
176566ZR48	Magnum 100 - Air Suspension - Bluebird & Carpenter - 5" Riser, Right Arm Only, PREVAIL®, Green	PREVAIL®	Green
176566DR87	Magnum 100 - Air Suspension - Bluebird & Carpenter - 5" Riser, Right Arm Only, PREVAIL®/Cloth, Black	PREVAIL®/Cloth	Black
176566DR86	Magnum 100 - Air Suspension - Bluebird & Carpenter - 5" Riser, Right Arm Only, PREVAIL®/Cloth, Brown	PREVAIL®/Cloth	Brown

Information & Images Provided by Seats, Inc.

Part Number	Description	Material	Color
176566DR85	Magnum 100 - Air Suspension - Bluebird & Carpenter - 5" Riser, Right Arm Only, PREVAIL®/Cloth, Gray	PREVAIL®/Cloth	Gray
176566DR84	Magnum 100 - Air Suspension - Bluebird & Carpenter - 5" Riser, Right Arm Only, PREVAIL®/Cloth, Green	PREVAIL®/Cloth	Green
176566FR31	Magnum 100 - Air Suspension - Bluebird & Carpenter - 5" Riser, Right Arm Only, TUFF-TEX™, Black	TUFF-TEX™	Black
176566FR33	Magnum 100 - Air Suspension - Bluebird & Carpenter - 5" Riser, Right Arm Only, TUFF-TEX™, Brown	TUFF-TEX™	Brown
176566FR35	Magnum 100 - Air Suspension - Bluebird & Carpenter - 5" Riser, Right Arm Only, TUFF-TEX™, Gray	TUFF-TEX™	Gray

BLUEBIRD & CARPENTER - BOTH ARMS

176566ZA45	Magnum 100 - Air Suspension - Bluebird & Carpenter - 5" Riser, Both Arms, PREVAIL®, Black	PREVAIL®	Black
176566ZA47	Magnum 100 - Air Suspension - Bluebird & Carpenter - 5" Riser, Both Arms, PREVAIL®, Brown	PREVAIL®	Brown
176566ZA94	Magnum 100 - Air Suspension - Bluebird & Carpenter - 5" Riser, Both Arms, PREVAIL®, Gray	PREVAIL®	Gray
176566ZA48	Magnum 100 - Air Suspension - Bluebird & Carpenter - 5" Riser, Both Arms, PREVAIL®, Green	PREVAIL®	Green
176566DA87	Magnum 100 - Air Suspension - Bluebird & Carpenter - 5" Riser, Both Arms, PREVAIL®/Cloth, Black	PREVAIL®/Cloth	Black
176566DA86	Magnum 100 - Air Suspension - Bluebird & Carpenter - 5" Riser, Both Arms, PREVAIL®/Cloth, Brown	PREVAIL®/Cloth	Brown
176566DA85	Magnum 100 - Air Suspension - Bluebird & Carpenter - 5" Riser, Both Arms, PREVAIL®/Cloth, Gray	PREVAIL®/Cloth	Gray
176566DA84	Magnum 100 - Air Suspension - Bluebird & Carpenter - 5" Riser, Both Arms, PREVAIL®/Cloth, Green	PREVAIL®/Cloth	Green
176566FA31	Magnum 100 - Air Suspension - Bluebird & Carpenter - 5" Riser, Both Arms, TUFF-TEX™, Black	TUFF-TEX™	Black
176566FA33	Magnum 100 - Air Suspension - Bluebird & Carpenter - 5" Riser, Both Arms, TUFF-TEX™, Brown	TUFF-TEX™	Brown
176566FA35	Magnum 100 - Air Suspension - Bluebird & Carpenter - 5" Riser, Both Arms, TUFF-TEX™, Gray	TUFF-TEX™	Gray

INTERNATIONAL/IC BUS (BEFORE MARCH 2004) & THOMAS BUILT - NO ARMS

176567ZN47	Magnum 100 - Air Suspension - International/IC Bus (Before March 2004) & Thomas Built - 3.83" Riser, No Arms, PREVAIL®, Brown	PREVAIL®	Brown
176567ZN94	Magnum 100 - Air Suspension - International/IC Bus (Before March 2004) & Thomas Built - 3.83" Riser, No Arms, PREVAIL®, Gray	PREVAIL®	Gray
176567ZN48	Magnum 100 - Air Suspension - International/IC Bus (Before March 2004) & Thomas Built - 3.83" Riser, No Arms, PREVAIL®, Green	PREVAIL®	Green
176567DN87	Magnum 100 - Air Suspension - International/IC Bus (Before March 2004) & Thomas Built - 3.83" Riser, No Arms, PREVAIL®/Cloth, Black	PREVAIL®/Cloth	Black
176567DN86	Magnum 100 - Air Suspension - International/IC Bus (Before March 2004) & Thomas Built - 3.83" Riser, No Arms, PREVAIL®/Cloth, Brown	PREVAIL®/Cloth	Brown
176567DN85	Magnum 100 - Air Suspension - International/IC Bus (Before March 2004) & Thomas Built - 3.83" Riser, No Arms, PREVAIL®/Cloth, Gray	PREVAIL®/Cloth	Gray
176567DN84	Magnum 100 - Air Suspension - International/IC Bus (Before March 2004) & Thomas Built - 3.83" Riser, No Arms, PREVAIL®/Cloth, Green	PREVAIL®/Cloth	Green
176567FN31	Magnum 100 - Air Suspension - International/IC Bus (Before March 2004) & Thomas Built - 3.83" Riser, No Arms, TUFF-TEX™, Black	TUFF-TEX™	Black
176567FN32	Magnum 100 - Air Suspension - International/IC Bus (Before March 2004) & Thomas Built - 3.83" Riser, No Arms, TUFF-TEX™, Blue	TUFF-TEX™	Blue

Information & Images Provided by Seats, Inc.

Part Number	Description	Material	Color
176567FN33	Magnum 100 - Air Suspension - International/IC Bus (Before March 2004) & Thomas Built - 3.83" Riser, No Arms, TUFF-TEX™, Brown	TUFF-TEX™	Brown

INTERNATIONAL/IC BUS (BEFORE MARCH 2004) & THOMAS BUILT - RIGHT ARM ONLY

176567DR87	Magnum 100 - Air Suspension - International/IC Bus (Before March 2004) & Thomas Built - 3.83" Riser, Right Arm Only, PREVAIL®/Cloth, Black	PREVAIL®/Cloth	Black
176567DR86	Magnum 100 - Air Suspension - International/IC Bus (Before March 2004) & Thomas Built - 3.83" Riser, Right Arm Only, PREVAIL®/Cloth, Brown	PREVAIL®/Cloth	Brown
176567DR85	Magnum 100 - Air Suspension - International/IC Bus (Before March 2004) & Thomas Built - 3.83" Riser, Right Arm Only, PREVAIL®/Cloth, Gray	PREVAIL®/Cloth	Gray
176567DR84	Magnum 100 - Air Suspension - International/IC Bus (Before March 2004) & Thomas Built - 3.83" Riser, Right Arm Only, PREVAIL®/Cloth, Green	PREVAIL®/Cloth	Green
176567ZR45	Magnum 100 - Air Suspension - International/IC Bus (Before March 2004) & Thomas Built - 3.83" Riser, Right Arm Only, PREVAIL®, Black	PREVAIL®	Black
176567ZR47	Magnum 100 - Air Suspension - International/IC Bus (Before March 2004) & Thomas Built - 3.83" Riser, Right Arm Only, PREVAIL®, Brown	PREVAIL®	Brown
176567ZR94	Magnum 100 - Air Suspension - International/IC Bus (Before March 2004) & Thomas Built - 3.83" Riser, Right Arm Only, PREVAIL®, Gray	PREVAIL®	Gray
176567ZR48	Magnum 100 - Air Suspension - International/IC Bus (Before March 2004) & Thomas Built - 3.83" Riser, Right Arm Only, PREVAIL®, Green	PREVAIL®	Green
176567ZR87	Magnum 100 - Air Suspension - International/IC Bus (Before March 2004) & Thomas Built - 3.83" Riser, Right Arm Only, PREVAIL®/ TUFF-TEX™, Black	PREVAIL®/ TUFF-TEX™	Black

INTERNATIONAL/IC BUS (BEFORE MARCH 2004) & THOMAS BUILT - BOTH ARMS

176567ZA45	Magnum 100 - Air Suspension - International/IC Bus (Before March 2004) & Thomas Built - 3.83" Riser, Both Arms, PREVAIL®, Black	PREVAIL®	Black
176567ZA47	Magnum 100 - Air Suspension - International/IC Bus (Before March 2004) & Thomas Built - 3.83" Riser, Both Arms, PREVAIL®, Brown	PREVAIL®	Brown
176567ZA94	Magnum 100 - Air Suspension - International/IC Bus (Before March 2004) & Thomas Built - 3.83" Riser, Both Arms, PREVAIL®, Gray	PREVAIL®	Gray
176567ZA48	Magnum 100 - Air Suspension - International/IC Bus (Before March 2004) & Thomas Built - 3.83" Riser, Both Arms, PREVAIL®, Green	PREVAIL®	Green
176567DA87	Magnum 100 - Air Suspension - International/IC Bus (Before March 2004) & Thomas Built - 3.83" Riser, Both Arms, PREVAIL®/Cloth, Black	PREVAIL®/Cloth	Black
176567DA86	Magnum 100 - Air Suspension - International/IC Bus (Before March 2004) & Thomas Built - 3.83" Riser, Both Arms, PREVAIL®/Cloth, Brown	PREVAIL®/Cloth	Brown
176567DA85	Magnum 100 - Air Suspension - International/IC Bus (Before March 2004) & Thomas Built - 3.83" Riser, Both Arms, PREVAIL®/Cloth, Gray	PREVAIL®/Cloth	Gray
176567DA84	Magnum 100 - Air Suspension - International/IC Bus (Before March 2004) & Thomas Built - 3.83" Riser, Both Arms, PREVAIL®/Cloth, Green	PREVAIL®/Cloth	Green
176567ZA87	Magnum 100 - Air Suspension - International/IC Bus (Before March 2004) & Thomas Built - 3.83" Riser, Both Arms, PREVAIL®/ TUFF-TEX™, Black	PREVAIL®/ TUFF-TEX™	Black
176567FA31	Magnum 100 - Air Suspension - International/IC Bus (Before March 2004) & Thomas Built - 3.83" Riser, Both Arms, TUFF-TEX™, Black	TUFF-TEX™	Black
176567FA32	Magnum 100 - Air Suspension - International/IC Bus (Before March 2004) & Thomas Built - 3.83" Riser, Both Arms, TUFF-TEX™, Blue	TUFF-TEX™	Blue

Information & Images Provided by Seats, Inc.

Part Number	Description	Material	Color
176567FA33	Magnum 100 - Air Suspension - International/IC Bus (Before March 2004) & Thomas Built - 3.83" Riser, Both Arms, TUFF-TEX™, Brown	TUFF-TEX™	Brown
176567FA35	Magnum 100 - Air Suspension - International/IC Bus (Before March 2004) & Thomas Built - 3.83" Riser, Both Arms, TUFF-TEX™, Gray	TUFF-TEX™	Gray

INTERNATIONAL/IC BUS (AFTER MARCH 2004) - No ARMS

180127ZN45	Magnum 100 - Air Suspension - International/IC Bus (After March 2004) - 3.83" Riser, No Arms, PREVAIL®, Black	PREVAIL®	Black
180127ZN369	Magnum 100 - Air Suspension - International/IC Bus (After March 2004) - 3.83" Riser, No Arms, PREVAIL®, Blue	PREVAIL®	Blue
180127ZN47	Magnum 100 - Air Suspension - International/IC Bus (After March 2004) - 3.83" Riser, No Arms, PREVAIL®, Brown	PREVAIL®	Brown
180127ZN94	Magnum 100 - Air Suspension - International/IC Bus (After March 2004) - 3.83" Riser, No Arms, PREVAIL®, Gray	PREVAIL®	Gray
180127ZN48	Magnum 100 - Air Suspension - International/IC Bus (After March 2004) - 3.83" Riser, No Arms, PREVAIL®, Green	PREVAIL®	Green
180127DN87	Magnum 100 - Air Suspension - International/IC Bus (After March 2004) - 3.83" Riser, No Arms, PREVAIL®/Cloth, Black	PREVAIL®/Cloth	Black
180127DN86	Magnum 100 - Air Suspension - International/IC Bus (After March 2004) - 3.83" Riser, No Arms, PREVAIL®/Cloth, Brown	PREVAIL®/Cloth	Brown
180127DN85	Magnum 100 - Air Suspension - International/IC Bus (After March 2004) - 3.83" Riser, No Arms, PREVAIL®/Cloth, Gray	PREVAIL®/Cloth	Gray
180127DN84	Magnum 100 - Air Suspension - International/IC Bus (After March 2004) - 3.83" Riser, No Arms, PREVAIL®/Cloth, Green	PREVAIL®/Cloth	Green

INTERNATIONAL/IC BUS (AFTER MARCH 2004) - RIGHT ARM ONLY

180127ZR45	Magnum 100 - Air Suspension - International/IC Bus (After March 2004) - 3.83" Riser, Right Arm Only, PREVAIL®, Black	PREVAIL®	Black
180127ZR47	Magnum 100 - Air Suspension - International/IC Bus (After March 2004) - 3.83" Riser, Right Arm Only, PREVAIL®, Brown	PREVAIL®	Brown
180127ZR94	Magnum 100 - Air Suspension - International/IC Bus (After March 2004) - 3.83" Riser, Right Arm Only, PREVAIL®, Gray	PREVAIL®	Gray
180127ZR48	Magnum 100 - Air Suspension - International/IC Bus (After March 2004) - 3.83" Riser, Right Arm Only, PREVAIL®, Green	PREVAIL®	Green
180127DR87	Magnum 100 - Air Suspension - International/IC Bus (After March 2004) - 3.83" Riser, Right Arm Only, PREVAIL®/Cloth, Black	PREVAIL®/Cloth	Black
180127DR86	Magnum 100 - Air Suspension - International/IC Bus (After March 2004) - 3.83" Riser, Right Arm Only, PREVAIL®/Cloth, Brown	PREVAIL®/Cloth	Brown
180127DR85	Magnum 100 - Air Suspension - International/IC Bus (After March 2004) - 3.83" Riser, Right Arm Only, PREVAIL®/Cloth, Gray	PREVAIL®/Cloth	Gray

Information & Images Provided by Seats, Inc.

Part Number	Description	Material	Color
180127DR84	Magnum 100 - Air Suspension - International/IC Bus (After March 2004) - 3.83" Riser, Right Arm Only, PREVAIL®/Cloth, Green	PREVAIL®/Cloth	Green

INTERNATIONAL/IC BUS (AFTER MARCH 2004) - BOTH ARMS

180127ZA45	Magnum 100 - Air Suspension - International/IC Bus (After March 2004) - 3.83" Riser, Both Arms, PREVAIL®, Black	PREVAIL®	Black
180127ZA47	Magnum 100 - Air Suspension - International/IC Bus (After March 2004) - 3.83" Riser, Both Arms, PREVAIL®, Brown	PREVAIL®	Brown
180127ZA94	Magnum 100 - Air Suspension - International/IC Bus (After March 2004) - 3.83" Riser, Both Arms, PREVAIL®, Gray	PREVAIL®	Gray
180127ZA48	Magnum 100 - Air Suspension - International/IC Bus (After March 2004) - 3.83" Riser, Both Arms, PREVAIL®, Green	PREVAIL®	Green
180127DA87	Magnum 100 - Air Suspension - International/IC Bus (After March 2004) - 3.83" Riser, Both Arms, PREVAIL®/Cloth, Black	PREVAIL®/Cloth	Black
180127DA86	Magnum 100 - Air Suspension - International/IC Bus (After March 2004) - 3.83" Riser, Both Arms, PREVAIL®/Cloth, Brown	PREVAIL®/Cloth	Brown
180127DA85	Magnum 100 - Air Suspension - International/IC Bus (After March 2004) - 3.83" Riser, Both Arms, PREVAIL®/Cloth, Gray	PREVAIL®/Cloth	Gray
180127DA84	Magnum 100 - Air Suspension - International/IC Bus (After March 2004) - 3.83" Riser, Both Arms, PREVAIL®/Cloth, Green	PREVAIL®/Cloth	Green

Information & Images Provided by Seats, Inc.

MAGNUM 200 - MECHANICAL SUSPENSION

- Seats Inc. Magnum School Bus Driver Seats
- FMV 222 Certified
- Highback
- Knee-Action Suspension
- 2-way adjusting mechanical lumbar
- 15° recline
- 6" Double-Locking Tracks
- Risers match Bus Types as listed below



Table 14-3: Driver's Seats - Bluebird & Carpenter

Part Number	Description	Material	Color
BLUEBIRD & CARPENTER - NO ARMS			
176568ZN45	Magnum 200 - Mechanical Suspension - Bluebird & Carpenter - 5" Riser, No Arms, PREVAIL®, Black	PREVAIL®	Black
176568ZN47	Magnum 200 - Mechanical Suspension - Bluebird & Carpenter - 5" Riser, No Arms, PREVAIL®, Brown	PREVAIL®	Brown
176568ZN94	Magnum 200 - Mechanical Suspension - Bluebird & Carpenter - 5" Riser, No Arms, PREVAIL®, Gray	PREVAIL®	Gray
176568ZN48	Magnum 200 - Mechanical Suspension - Bluebird & Carpenter - 5" Riser, No Arms, PREVAIL®, Green	PREVAIL®	Green
176568DN87	Magnum 200 - Mechanical Suspension - Bluebird & Carpenter - 5" Riser, No Arms, PREVAIL®/ Cloth, Black	PREVAIL®/ Cloth	Black
176568DN86	Magnum 200 - Mechanical Suspension - Bluebird & Carpenter - 5" Riser, No Arms, PREVAIL®/ Cloth, Brown	PREVAIL®/ Cloth	Brown
176568DN85	Magnum 200 - Mechanical Suspension - Bluebird & Carpenter - 5" Riser, No Arms, PREVAIL®/ Cloth, Gray	PREVAIL®/ Cloth	Gray
176568DN84	Magnum 200 - Mechanical Suspension - Bluebird & Carpenter - 5" Riser, No Arms, PREVAIL®/ Cloth, Green	PREVAIL®/ Cloth	Green
176568FN31	Magnum 200 - Mechanical Suspension - Bluebird & Carpenter - 5" Riser, No Arms, TUFF-TEX™, Black	TUFF-TEX™	Black
176568FN35	Magnum 200 - Mechanical Suspension - Bluebird & Carpenter - 5" Riser, No Arms, TUFF-TEX™, Gray	TUFF-TEX™	Gray

BLUEBIRD & CARPENTER - RIGHT ARM ONLY

176568ZR45	Magnum 200 - Mechanical Suspension - Bluebird & Carpenter - 5" Riser, Right Arm Only, PREVAIL®, Black	PREVAIL®	Black
176568ZR47	Magnum 200 - Mechanical Suspension - Bluebird & Carpenter - 5" Riser, Right Arm Only, PREVAIL®, Brown	PREVAIL®	Brown

Information & Images Provided by Seats, Inc.

Part Number	Description	Material	Color
176568ZR94	Magnum 200 - Mechanical Suspension - Bluebird & Carpenter - 5" Riser, Right Arm Only, PREVAIL®, Gray	PREVAIL®	Gray
176568ZR48	Magnum 200 - Mechanical Suspension - Bluebird & Carpenter - 5" Riser, Right Arm Only, PREVAIL®, Green	PREVAIL®	Green
176568DR87	Magnum 200 - Mechanical Suspension - Bluebird & Carpenter - 5" Riser, Right Arm Only, PREVAIL®/ Cloth, Black	PREVAIL®/ Cloth	Black
176568DR86	Magnum 200 - Mechanical Suspension - Bluebird & Carpenter - 5" Riser, Right Arm Only, PREVAIL®/ Cloth, Brown	PREVAIL®/ Cloth	Brown
176568DR85	Magnum 200 - Mechanical Suspension - Bluebird & Carpenter - 5" Riser, Right Arm Only, PREVAIL®/ Cloth, Gray	PREVAIL®/ Cloth	Gray
176568DR84	Magnum 200 - Mechanical Suspension - Bluebird & Carpenter - 5" Riser, Right Arm Only, PREVAIL®/ Cloth, Green	PREVAIL®/ Cloth	Green
176568FR31	Magnum 200 - Mechanical Suspension - Bluebird & Carpenter - 5" Riser, Right Arm Only, TUFF-TEX™, Black	TUFF-TEX™	Black
176568FR35	Magnum 200 - Mechanical Suspension - Bluebird & Carpenter - 5" Riser, Right Arm Only, TUFF-TEX™, Gray	TUFF-TEX™	Gray

BLUEBIRD & CARPENTER - BOTH ARMS

176568ZA45	Magnum 200 - Mechanical Suspension - Bluebird & Carpenter - 5" Riser, Both Arms, PREVAIL®, Black	PREVAIL®	Black
176568ZA47	Magnum 200 - Mechanical Suspension - Bluebird & Carpenter - 5" Riser, Both Arms, PREVAIL®, Brown	PREVAIL®	Brown
176568ZA94	Magnum 200 - Mechanical Suspension - Bluebird & Carpenter - 5" Riser, Both Arms, PREVAIL®, Gray	PREVAIL®	Gray
176568ZA48	Magnum 200 - Mechanical Suspension - Bluebird & Carpenter - 5" Riser, Both Arms, PREVAIL®, Green	PREVAIL®	Green
176568DA87	Magnum 200 - Mechanical Suspension - Bluebird & Carpenter - 5" Riser, Both Arms, PREVAIL®/ Cloth, Black	PREVAIL®/ Cloth	Black
176568DA86	Magnum 200 - Mechanical Suspension - Bluebird & Carpenter - 5" Riser, Both Arms, PREVAIL®/ Cloth, Brown	PREVAIL®/ Cloth	Brown
176568DA85	Magnum 200 - Mechanical Suspension - Bluebird & Carpenter - 5" Riser, Both Arms, PREVAIL®/ Cloth, Gray	PREVAIL®/ Cloth	Gray
176568DA84	Magnum 200 - Mechanical Suspension - Bluebird & Carpenter - 5" Riser, Both Arms, PREVAIL®/ Cloth, Green	PREVAIL®/ Cloth	Green
176568FA31	Magnum 200 - Mechanical Suspension - Bluebird & Carpenter - 5" Riser, Both Arms, TUFF-TEX™, Black	TUFF-TEX™	Black
176568FA35	Magnum 200 - Mechanical Suspension - Bluebird & Carpenter - 5" Riser, Both Arms, TUFF-TEX™, Gray	TUFF-TEX™	Gray

INTERNATIONAL/IC BUS (BEFORE MARCH 2004) & THOMAS BUILT - NO ARMS

176569ZN45	Magnum 200 - Mechanical Suspension - International/IC Bus (Before March 2004) & Thomas Built - 3.83" Riser, No Arms, PREVAIL®, Black	PREVAIL®	Black
176569ZN47	Magnum 200 - Mechanical Suspension - International/IC Bus (Before March 2004) & Thomas Built - 3.83" Riser, No Arms, PREVAIL®, Brown	PREVAIL®	Brown
176569ZN94	Magnum 200 - Mechanical Suspension - International/IC Bus (Before March 2004) & Thomas Built - 3.83" Riser, No Arms, PREVAIL®, Gray	PREVAIL®	Gray
176569ZN48	Magnum 200 - Mechanical Suspension - International/IC Bus (Before March 2004) & Thomas Built - 3.83" Riser, No Arms, PREVAIL®, Green	PREVAIL®	Green

Information & Images Provided by Seats, Inc.

Part Number	Description	Material	Color
176569DN87	Magnum 200 - Mechanical Suspension - International/IC Bus (Before March 2004) & Thomas Built - 3.83" Riser, No Arms, PREVAIL®/Cloth, Black	PREVAIL®/Cloth	Black
176569DN86	Magnum 200 - Mechanical Suspension - International/IC Bus (Before March 2004) & Thomas Built - 3.83" Riser, No Arms, PREVAIL®/Cloth, Brown	PREVAIL®/Cloth	Brown
176569DN85	Magnum 200 - Mechanical Suspension - International/IC Bus (Before March 2004) & Thomas Built - 3.83" Riser, No Arms, PREVAIL®/Cloth, Gray	PREVAIL®/Cloth	Gray
176569DN84	Magnum 200 - Mechanical Suspension - International/IC Bus (Before March 2004) & Thomas Built - 3.83" Riser, No Arms, PREVAIL®/Cloth, Green	PREVAIL®/Cloth	Green
176569FN31	Magnum 200 - Mechanical Suspension - International/IC Bus (Before March 2004) & Thomas Built - 3.83" Riser, No Arms, TUFF-TEX™, Black	TUFF-TEX™	Black
176569FN35	Magnum 200 - Mechanical Suspension - International/IC Bus (Before March 2004) & Thomas Built - 3.83" Riser, No Arms, TUFF-TEX™, Gray	TUFF-TEX™	Gray

INTERNATIONAL/IC BUS (BEFORE MARCH 2004) & THOMAS BUILT - RIGHT ARM ONLY

176569ZR45	Magnum 200 - Mechanical Suspension - International/IC Bus (Before March 2004) & Thomas Built - 3.83" Riser, Right Arm Only, PREVAIL®, Black	PREVAIL®	Black
176569ZR47	Magnum 200 - Mechanical Suspension - International/IC Bus (Before March 2004) & Thomas Built - 3.83" Riser, Right Arm Only, PREVAIL®, Brown	PREVAIL®	Brown
176569ZR94	Magnum 200 - Mechanical Suspension - International/IC Bus (Before March 2004) & Thomas Built - 3.83" Riser, Right Arm Only, PREVAIL®, Gray	PREVAIL®	Gray
176569ZR48	Magnum 200 - Mechanical Suspension - International/IC Bus (Before March 2004) & Thomas Built - 3.83" Riser, Right Arm Only, PREVAIL®, Green	PREVAIL®	Green
176569DR87	Magnum 200 - Mechanical Suspension - International/IC Bus (Before March 2004) & Thomas Built - 3.83" Riser, Right Arm Only, PREVAIL®/Cloth, Black	PREVAIL®/Cloth	Black
176569DR86	Magnum 200 - Mechanical Suspension - International/IC Bus (Before March 2004) & Thomas Built - 3.83" Riser, Right Arm Only, PREVAIL®/Cloth, Brown	PREVAIL®/Cloth	Brown
176569DR85	Magnum 200 - Mechanical Suspension - International/IC Bus (Before March 2004) & Thomas Built - 3.83" Riser, Right Arm Only, PREVAIL®/Cloth, Gray	PREVAIL®/Cloth	Gray
176569DR84	Magnum 200 - Mechanical Suspension - International/IC Bus (Before March 2004) & Thomas Built - 3.83" Riser, Right Arm Only, PREVAIL®/Cloth, Green	PREVAIL®/Cloth	Green

INTERNATIONAL/IC BUS (BEFORE MARCH 2004) & THOMAS BUILT - BOTH ARMS

176569ZA45	Magnum 200 - Mechanical Suspension - International/IC Bus (Before March 2004) & Thomas Built - 3.83" Riser, Both Arms, PREVAIL®, Black	PREVAIL®	Black
176569ZA47	Magnum 200 - Mechanical Suspension - International/IC Bus (Before March 2004) & Thomas Built - 3.83" Riser, Both Arms, PREVAIL®, Brown	PREVAIL®	Brown
176569ZA94	Magnum 200 - Mechanical Suspension - International/IC Bus (Before March 2004) & Thomas Built - 3.83" Riser, Both Arms, PREVAIL®, Gray	PREVAIL®	Gray
176569ZA48	Magnum 200 - Mechanical Suspension - International/IC Bus (Before March 2004) & Thomas Built - 3.83" Riser, Both Arms, PREVAIL®, Green	PREVAIL®	Green

Information & Images Provided by Seats, Inc.

Part Number	Description	Material	Color
176569DA87	Magnum 200 - Mechanical Suspension - International/IC Bus (Before March 2004) & Thomas Built - 3.83" Riser, Both Arms, PREVAIL®/Cloth, Black	PREVAIL®/Cloth	Black
176569DA86	Magnum 200 - Mechanical Suspension - International/IC Bus (Before March 2004) & Thomas Built - 3.83" Riser, Both Arms, PREVAIL®/Cloth, Brown	PREVAIL®/Cloth	Brown
176569DA85	Magnum 200 - Mechanical Suspension - International/IC Bus (Before March 2004) & Thomas Built - 3.83" Riser, Both Arms, PREVAIL®/Cloth, Gray	PREVAIL®/Cloth	Gray
176569DA84	Magnum 200 - Mechanical Suspension - International/IC Bus (Before March 2004) & Thomas Built - 3.83" Riser, Both Arms, PREVAIL®/Cloth, Green	PREVAIL®/Cloth	Green

INTERNATIONAL/IC BUS (AFTER MARCH 2004) - NO ARMS

180128YN372	Magnum 200 - Mechanical Suspension - International/IC Bus (After March 2004) - 3.83" Riser, No Arms, Kevlar®, Black	Kevlar®	Black
180128YN374	Magnum 200 - Mechanical Suspension - International/IC Bus (After March 2004) - 3.83" Riser, No Arms, Kevlar®, Blue	Kevlar®	Blue
180128YN373	Magnum 200 - Mechanical Suspension - International/IC Bus (After March 2004) - 3.83" Riser, No Arms, Kevlar®, Brown	Kevlar®	Brown
180128YN371	Magnum 200 - Mechanical Suspension - International/IC Bus (After March 2004) - 3.83" Riser, No Arms, Kevlar®, Gray	Kevlar®	Gray
180128YN370	Magnum 200 - Mechanical Suspension - International/IC Bus (After March 2004) - 3.83" Riser, No Arms, Kevlar®, Green	Kevlar®	Green
180128YN382	Magnum 200 - Mechanical Suspension - International/IC Bus (After March 2004) - 3.83" Riser, No Arms, Kevlar®/Sherpa, Black	Kevlar®/Sherpa	Black
180128YN384	Magnum 200 - Mechanical Suspension - International/IC Bus (After March 2004) - 3.83" Riser, No Arms, Kevlar®/Sherpa, Blue	Kevlar®/Sherpa	Blue
180128YN383	Magnum 200 - Mechanical Suspension - International/IC Bus (After March 2004) - 3.83" Riser, No Arms, Kevlar®/Sherpa, Brown	Kevlar®/Sherpa	Brown
180128YN381	Magnum 200 - Mechanical Suspension - International/IC Bus (After March 2004) - 3.83" Riser, No Arms, Kevlar®/Sherpa, Gray	Kevlar®/Sherpa	Gray
180128YN380	Magnum 200 - Mechanical Suspension - International/IC Bus (After March 2004) - 3.83" Riser, No Arms, Kevlar®/Sherpa, Green	Kevlar®/Sherpa	Green
180128ZN45	Magnum 200 - Mechanical Suspension - International/IC Bus (After March 2004) - 3.83" Riser, No Arms, PREVAIL®, Black	PREVAIL®	Black
180128ZN369	Magnum 200 - Mechanical Suspension - International/IC Bus (After March 2004) - 3.83" Riser, No Arms, PREVAIL®, Blue	PREVAIL®	Blue
180128ZN47	Magnum 200 - Mechanical Suspension - International/IC Bus (After March 2004) - 3.83" Riser, No Arms, PREVAIL®, Brown	PREVAIL®	Brown
180128ZN94	Magnum 200 - Mechanical Suspension - International/IC Bus (After March 2004) - 3.83" Riser, No Arms, PREVAIL®, Gray	PREVAIL®	Gray
180128ZN48	Magnum 200 - Mechanical Suspension - International/IC Bus (After March 2004) - 3.83" Riser, No Arms, PREVAIL®, Green	PREVAIL®	Green
180128DN87	Magnum 200 - Mechanical Suspension - International/IC Bus (After March 2004) - 3.83" Riser, No Arms, PREVAIL®/Cloth, Black	PREVAIL®/Cloth	Black
180128DN86	Magnum 200 - Mechanical Suspension - International/IC Bus (After March 2004) - 3.83" Riser, No Arms, PREVAIL®/Cloth, Brown	PREVAIL®/Cloth	Brown

Information & Images Provided by Seats, Inc.

Part Number	Description	Material	Color
180128DN85	Magnum 200 - Mechanical Suspension - International/IC Bus (After March 2004) - 3.83" Riser, No Arms, PREVAIL®/Cloth, Gray	PREVAIL®/Cloth	Gray
180128DN84	Magnum 200 - Mechanical Suspension - International/IC Bus (After March 2004) - 3.83" Riser, No Arms, PREVAIL®/Cloth, Green	PREVAIL®/Cloth	Green

INTERNATIONAL/IC BUS (AFTER MARCH 2004) - RIGHT ARM ONLY

180128ZR45	Magnum 200 - Mechanical Suspension - International/IC Bus (After March 2004) - 3.83" Riser, Right Arm Only, PREVAIL®, Black	PREVAIL®	Black
180128ZR47	Magnum 200 - Mechanical Suspension - International/IC Bus (After March 2004) - 3.83" Riser, Right Arm Only, PREVAIL®, Brown	PREVAIL®	Brown
180128ZR94	Magnum 200 - Mechanical Suspension - International/IC Bus (After March 2004) - 3.83" Riser, Right Arm Only, PREVAIL®, Gray	PREVAIL®	Gray
180128ZR48	Magnum 200 - Mechanical Suspension - International/IC Bus (After March 2004) - 3.83" Riser, Right Arm Only, PREVAIL®, Green	PREVAIL®	Green
180128DR87	Magnum 200 - Mechanical Suspension - International/IC Bus (After March 2004) - 3.83" Riser, Right Arm Only, PREVAIL®/Cloth, Black	PREVAIL®/Cloth	Black
180128DR86	Magnum 200 - Mechanical Suspension - International/IC Bus (After March 2004) - 3.83" Riser, Right Arm Only, PREVAIL®/Cloth, Brown	PREVAIL®/Cloth	Brown
180128DR85	Magnum 200 - Mechanical Suspension - International/IC Bus (After March 2004) - 3.83" Riser, Right Arm Only, PREVAIL®/Cloth, Gray	PREVAIL®/Cloth	Gray
180128DR84	Magnum 200 - Mechanical Suspension - International/IC Bus (After March 2004) - 3.83" Riser, Right Arm Only, PREVAIL®/Cloth, Green	PREVAIL®/Cloth	Green

INTERNATIONAL/IC BUS (AFTER MARCH 2004) - BOTH ARMS

180128ZA45	Magnum 200 - Mechanical Suspension - International/IC Bus (After March 2004) - 3.83" Riser, Both Arms, PREVAIL®, Black	PREVAIL®	Black
180128ZA47	Magnum 200 - Mechanical Suspension - International/IC Bus (After March 2004) - 3.83" Riser, Both Arms, PREVAIL®, Brown	PREVAIL®	Brown
180128ZA94	Magnum 200 - Mechanical Suspension - International/IC Bus (After March 2004) - 3.83" Riser, Both Arms, PREVAIL®, Gray	PREVAIL®	Gray
180128ZA48	Magnum 200 - Mechanical Suspension - International/IC Bus (After March 2004) - 3.83" Riser, Both Arms, PREVAIL®, Green	PREVAIL®	Green
180128DA87	Magnum 200 - Mechanical Suspension - International/IC Bus (After March 2004) - 3.83" Riser, Both Arms, PREVAIL®/Cloth, Black	PREVAIL®/Cloth	Black
180128DA86	Magnum 200 - Mechanical Suspension - International/IC Bus (After March 2004) - 3.83" Riser, Both Arms, PREVAIL®/Cloth, Brown	PREVAIL®/Cloth	Brown
180128DA85	Magnum 200 - Mechanical Suspension - International/IC Bus (After March 2004) - 3.83" Riser, Both Arms, PREVAIL®/Cloth, Gray	PREVAIL®/Cloth	Gray
180128DA84	Magnum 200 - Mechanical Suspension - International/IC Bus (After March 2004) - 3.83" Riser, Both Arms, PREVAIL®/Cloth, Green	PREVAIL®/Cloth	Green

Information & Images Provided by Seats, Inc.

SEAT COVERS



- Seats Inc. Bus Driver Seat Covers
- Heavy-Duty 900 Denier Polyester-Canvas
- Stain-Resistant
- Easy Cinch Fit
- 6 pockets on back and cushion for better organization



Table 14-4: Driver's Seat Coveralls – Highback

Part Number	Description	Color
COVERALLS – HIGHBACK		
181704XN1161	Seat Cover, Heavy-Duty Polyester-Canvas, Cinch Fit, 6 pockets on back and cushion, Black on Black	Black on Black
181704XN1162	Seat Cover, Heavy-Duty Polyester-Canvas, Cinch Fit, 6 pockets on back and cushion, Black on Blue	Black on Blue
181704XN1163	Seat Cover, Heavy-Duty Polyester-Canvas, Cinch Fit, 6 pockets on back and cushion, Black on Brown	Black on Brown
181704XN1165	Seat Cover, Heavy-Duty Polyester-Canvas, Cinch Fit, 6 pockets on back and cushion, Black on Gray	Black on Gray

Information & Images Provided by Seats, Inc.



*For information, updates, or corrections,
please contact us at TRPBus@TRPParts.com*

*No part of this marketing material may be
reproduced in any manner without written
permission from TRP® North America.*

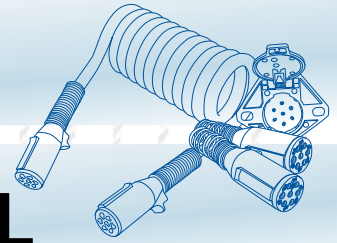
TRP® North America

750 Houser Way N.
Renton, WA 98057

www.trpparts.com



Parts for all brands of buses.



15

BUS PARTS

ELECTRICAL

*Proven, reliable and
always innovative.*

TRP® offers reliable aftermarket products that are designed and tested to exceed customers' expectations regardless of the bus make, model or age.



ALTERNATORS • BATTERIES • CABLES •
FLASHERS • STARTERS



BUS PARTS

Tested. Reliable. Guaranteed.

Electrical

Choosing the right replacement part or service for your vehicle—whether you own one, or a fleet—is one of the most important decisions you can make for your business. And, with tested TRP® parts it's an easy decision.

Regardless of the make you drive, TRP® quality replacement parts are engineered to fit your truck, trailer or bus. Choose the parts that give you the best value for your business. Check them out at an approved TRP® retailer near you.

The cross reference information in this catalog is based upon data provided by several industry sources and our partners. While every attempt is made to ensure the information presented is accurate, we bear no liability due to incorrect or incomplete information.

Product Availability

Due to export restrictions and market demands, not all products are always available in every location. Check for availability in your area with your local TRP® Distributor.

No part of this marketing material may be reproduced in any manner without written permission from TRP® North America.

CONTENTS

ALTERNATORS

- [Alternators – Delco Remy](#) 15-5
- [Alternators – Leece Neville](#) 15-6

STARTERS

- [Starters – Delco Remy](#) 15-7
- [Starters – Leece Neville](#) 15-8
- [Starters – Mitsubishi](#) 15-9

BATTERIES (EXCLUDES MEXICO)

- [AGM, Dual Purpose, & Starting Batteries](#) 15-11

BATTERIES (MEXICO ONLY)

- [Starting Batteries](#) 15-12

BATTERY CABLES

- [Battery Cables](#) 15-13
 - [Straight Ring Terminals](#) 15-14
 - [Straight Ring Terminals](#) 15-14
 - [90° Ring Terminals](#) 15-14
 - [Elbow Ring Terminals](#) 15-15
- [Cable Splices](#) 15-15
 - [Cable Splices](#) 15-15
 - [Elbow Ring Terminals](#) 15-15
- [Tapered Post Connectors](#) 15-16
 - [Straight Clamps](#) 15-16
 - [Elbow Clamps](#) 15-16

TRP® North America

750 Houser Way N.
Renton, WA 98057

www.trpparts.com

- [Flag Clamps](#) 15-17
 - [Straight Clamps - Universal Compression](#) 15-17
- [End Protectors, Tubing & Accessories](#) 15-18
 - [Battery Cable Nut Caps](#) 15-18
 - [Straight Clamp Protectors](#) 15-18
 - [Flag Clamp Protectors](#) 15-18
 - [Heavy Duty Starter Protectors](#) 15-18
 - [Elbow Clamps Protectors](#) 15-19
 - [Battery Cable Clamps - Heat Shrink](#) 15-19
 - [Split Loom \(Convuluted Tubing\)](#) 15-19
- [Negative Battery Cables](#) 15-20
 - [Negative Battery Cables](#) 15-20

SWITCHES

- [Assorted Switches](#) 15-21
- [Pressure Switches](#) 15-22
- [Push Button Switches](#) 15-23
 - [Dash Switches](#) 15-23
 - [Door/Courtesy Lamp Switches](#) 15-23
 - [Miscellaneous Switches](#) 15-23
 - [Momentary Start Switches](#) 15-23
- [Rocker Switches](#) 15-24
- [Toggle Switches](#) 15-25

CONNECTORS

- [Connector Bodies/Shells](#) 15-26
 - [1 Wire](#) 15-26
 - [2 Wire](#) 15-27
 - [3 Wire](#) 15-28
 - [4 Wire](#) 15-29
 - [5 Wire](#) 15-30
 - [6 Wire](#) 15-31
 - [Additional Wire Sizes](#) 15-32
- [Universal Circuit Breaker for ATC®/ATO®](#)
- [Blade Type Fuses](#) 15-34

- [Long ATC™/ATO™ Terminal Type](#) 15-35
- [Long ATC™/ATO™ Terminal Type with Locking Dimples](#) 15-35
- [MAXI™ Terminal Type](#) 15-35
- [Wide ATC™/ATO™ Terminal Type](#) 15-35
- [Stud Terminal Circuit Breakers](#) 15-35
 - [Stud & Mounting Bracket](#) 15-36
 - [Stud and Blade Terminals](#) 15-36
 - [Stud Terminals](#) 15-36
- [Thermal Circuit Breakers](#) 15-37
 - [Blade w/ Screw Terminals](#) 15-37
 - [Snap-In Mounting](#) 15-37
 - [Stud Terminal Mounting](#) 15-37
- [Relays](#) 15-38
- [Relay Blocks and Fuse Blocks](#) 15-38

FLASHERS

- [Flashers](#) 15-40

WIRE CONNECTORS

- [Terminal Ends - Spade/Slide](#) 15-41
 - [Female](#) 15-41
 - [Male](#) 15-43
 - [Miscellaneous](#) 15-43
- [Sleeves, Sockets, Pins](#) 15-44
 - [AMP](#) 15-44
 - [Cardell Pin](#) 15-45
 - [Deutsch Socket](#) 15-45
 - [Deutsch Socket, Gold Pinning](#) 15-45
 - [Deutsch Socket, Gold Plating](#) 15-45
 - [Packard](#) 15-45
- [Terminal Ends for Fuses & Relays](#) 15-46
- [Terminal Blocks and Bus Bars](#) 15-47
- [Seals, Retainers, & Combs](#) 15-47
 - [Cable Seals](#) 15-47
 - [Cavity Plugs](#) 15-47
 - [Locks](#) 15-47

WedgeLock 15-48
 Butt Splices 15-48
 Heat Shrinkable, Butt Splice 15-48
Miscellaneous Connectors & Plugs 15-49
Splice Connectors 15-49

CABLE TIES

Standard & Stainless Steel 15-50
 Stainless Steel 15-50
 Standard 15-51
Specialty Ties 15-52
 Button Head 15-52
 Dual Clamp 15-53
 Mountable 15-53
 Releasable 15-53

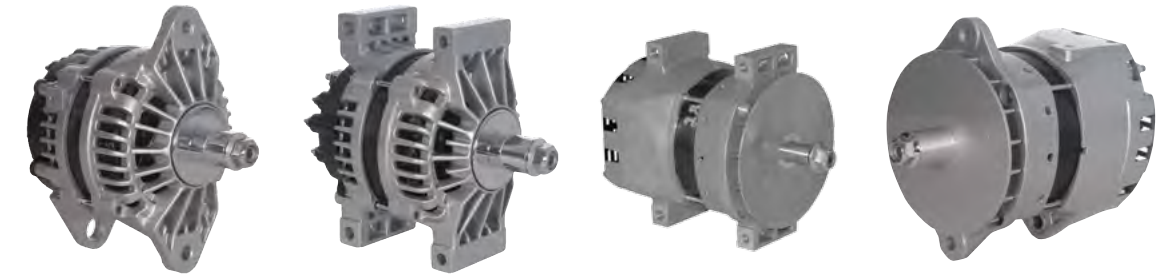
TOOLS

Deutsch Connector Tools 15-54
Miscellaneous Tools 15-55
Cable Tie Tools 15-55

CROSS REFERENCE

Cross Reference for Electrical 15-56

ALTERNATORS

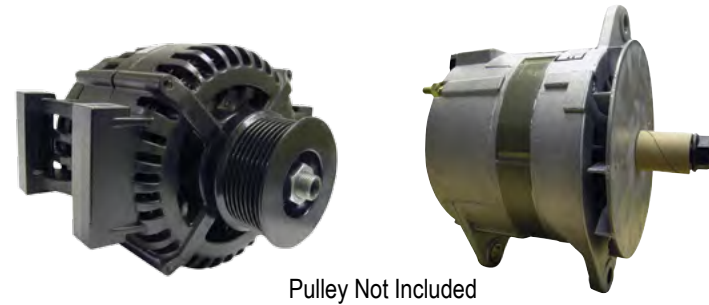


ALTERNATORS – DELCO REMY

Table 15-1: Alternators - Delco Remy

Part Number	Description	Amp	Mount
8600315	Alternator - 28SI School bus minimum requirement prior to 2000, 160 Amp, Pad Mount	160	Pad
8600312	Alternator - 28SI School bus minimum requirement prior to 2000, 160 Amp, Short Hinge Mount	160	Short Hinge
8600308	Alternator - 28SI School bus minimum requirement prior to 2000, 160 Amp, Long Hinge Mount	160	Long Hinge
8600316	Alternator - 28SI Any school bus without A/C, 180 Amp, Pad Mount	180	Pad
8600223	Alternator - 28SI Any school bus without A/C, 180 Amp, Short Hinge Mount	180	Short Hinge
8600311	Alternator - 28SI Any school bus without A/C, 180 Amp, Long Hinge Mount	180	Long Hinge
8600314	Alternator - 28SI Any school bus with one A/C unit or an electromagnetic brake retarder, 200 Amp, Pad Mount	200	Pad
8600313	Alternator - 28SI Any school bus with one A/C unit or an electromagnetic brake retarder, 200 Amp, Short Hinge Mount	200	Short Hinge
8600307	Alternator - 28SI Any school bus with one A/C unit or an electromagnetic brake retarder, 200 Amp, Long Hinge Mount	200	Long Hinge
8600338	Alternator - 40SI Any school bus with one A/C unit or an electromagnetic brake retarder, 240 Amp, Pad Mount	240	Pad
8600339	Alternator - 40SI Any school bus with one A/C unit or an electromagnetic brake retarder, 240 Amp, Short Hinge Mount	240	Short Hinge
8600390	Alternator - 40SI Any school bus with one A/C unit or an electromagnetic brake retarder, 240 Amp, Long Hinge Mount	240	Long Hinge
8600094	Alternator - 40SI Any school bus with two A/C units or one A/C and an electromagnetic brake retarder, 275 Amp, Pad Mount	275	Pad
8600279	Alternator - 40SI Any school bus with two A/C units or one A/C and an electromagnetic brake retarder, 275 Amp, Short Hinge Mount	275	Short Hinge
8600280	Alternator - 40SI Any school bus with two A/C units or one A/C and an electromagnetic brake retarder, 275 Amp, Long Hinge Mount	275	Long Hinge
8600298	Alternator - 40SI Any school bus with two A/C units or one A/C and an electromagnetic brake retarder, 300 Amp, Pad Mount	300	Pad
8600299	Alternator - 40SI Any school bus with two A/C units or one A/C and an electromagnetic brake retarder, 300 Amp, Short Hinge Mount	300	Short Hinge
8600300	Alternator - 40SI Any school bus with two A/C units or one A/C and an electromagnetic brake retarder, 300 Amp, Long Hinge Mount	300	Long Hinge

Information & Images Provided by Delco Remy



Pulley Not Included

ALTERNATORS – LEECE-NEVILLE

Table 15-2: Alternators - Leece-Neville

Part Number	Description	Amp	Mount
2800LC	Alternator - School bus minimum requirement prior to 2000	160	J180
4833LGH	Alternator - Any school bus without A/C 2000-2009	185	J180
4836LGH	Alternator - Any school bus without A/C 2000-2009	185	J180
4836AAH	Alternator - Any school bus without A/C	185	J180
4846AAH	Alternator - Any school bus without A/C	185	J180
4939AAH	Alternator - Any school bus without A/C	185	Pad
4939PGH	Alternator - Any school bus without A/C 2000-2009	185	Pad
4943PGH	Alternator - Any school bus without A/C 2000-2009	185	Pad
4945AAH	Alternator - Any school bus without A/C	185	Pad
4860JB	Alternator - Any school bus with one A/C unit or an electromagnetic brake retarder	200	J180
4863JB	Alternator - Any school bus with one A/C unit or an electromagnetic brake retarder	200	J180
4940PA	Alternator - Any school bus with one A/C unit or an electromagnetic brake retarder	200	Pad
4951PGH	Alternator - Any school bus with one A/C unit or an electromagnetic brake retarder	200	Pad
AV1160J2008	Alternator - Internally vented - Any school bus with one A/C unit or an electromagnetic brake retarder	210	J180
AV1160P2007	Alternator - Internally vented - Any school bus with one A/C unit or an electromagnetic brake retarder	210	Pad
4959PA	Alternator - Any school bus with one A/C unit - 2000-2009	220	Pad
4958PA	Alternator - Any school bus with one A/C unit - 2000-2009	220	Pad
4887JB	Alternator - Any school bus with one A/C unit - 2000-2009	220	J180
4885JB	Alternator - Any school bus with one A/C unit - 2000-2009	220	J180
AV1160P2003	Alternator - Internally vented - Base requirement 2010 and later engines	240	Pad
4867JB	Alternator - Any school bus with two A/C units or one A/C and an electromagnetic brake retarder (2000-2009)	270	J180
4870JB	Alternator - Any school bus with two A/C units or one A/C and an electromagnetic brake retarder	270	J180
4942PA	Alternator - Any school bus with two A/C units or one A/C and an electromagnetic brake retarder	270	Pad
4944PA	Alternator - Any school bus with two A/C units or one A/C and an electromagnetic brake retarder	270	Pad
4947PA	Alternator - Any school bus with two A/C units or one A/C and an electromagnetic brake retarder	270	Pad
4949PA	Alternator - Any school bus with two A/C units or one A/C and an electromagnetic brake retarder (2000-2009) or school bus with one A/C 2010 and later	270	Pad
4890JB	Alternator - Any school bus with two A/C units and an electromagnetic brake retarder	320	J180
4962PA	Alternator - Any school bus with two A/C units and an electromagnetic brake retarder	320	Pad

Information & Images Provided by Leece-Neville

STARTERS



Delco Remy 29MT



Delco Remy 38MT

STARTERS – DELCO REMY

Table 15-3: Starters - Delco Remy

Part Number	Description	Engine	Popular Application	Volts	Output	Over Crank Protection	Nose (Fixed or Rotatable)	Teeth
19011400	Starter 29MT, 12V, Cummins ISB 5.9, Thomas Bus, 3.3 kW, No OCP, Fixed Nose, 10 Teeth	Cummins ISB 5.9	Thomas Built Bus	12	3.3 kW	No	Fixed	10
8200196	Starter 29MT, 12V, Cummins ISB 6.7, Thomas Bus, 3.3 kW, No OCP, Fixed Nose, 10 Teeth	Cummins ISB 6.7	Thomas Built Bus	12	3.3 kW	No	Fixed	10
8200005	Starter 38MT, 12V, Cummins ISC / ISL, Thomas Bus, 4.6 kW, No OCP, Fixed Nose, 12 Teeth	Cummins ISC / ISL	Thomas Built Bus	12	4.6 kW	No	Fixed	12
8200076	Starter 38MT, 12V, CAT 3126, CAT C7, Thomas Bus, 4.6 kW, No OCP, Fixed Nose, 10 Teeth	Caterpillar 3126; CAT C7	Thomas Built Bus	12	4.6 kW	No	Fixed	10
8200075	Starter 38MT, 12V, MB 926, Thomas Bus, 4.6 kW, No OCP, Fixed Nose, 11 Teeth	Mercedes-Benz 926	Thomas Built Bus	12	4.6 kW	No	Fixed	11
8200103	Starter 29MT, 12V, Thomas Bus, 3.3 kW, No OCP, Fixed Nose, 9 Teeth	Mercedes-Benz 904 / 906	Thomas Built Bus	12	3.3 kW	No	Fixed	9
19011400	Starter 29MT, 12V, Cummins ISB 5.9, Blue Bird, 3.3 kW, No OCP, Fixed Nose, 10 Teeth	Cummins ISB 5.9	Blue Bird	12	3.3 kW	No	Fixed	10
8200196	Starter 29MT, 12V, Cummins ISB 6.7, Blue Bird, 3.3 kW, No OCP, Fixed Nose, 10 Teeth	Cummins ISB 6.7	Blue Bird	12	3.3 kW	No	Fixed	10
8200005	Starter 38MT, 12V, Cummins ISC, Blue Bird, 4.6 kW, No OCP, Fixed Nose, 12 Teeth	Cummins ISC	Blue Bird	12	4.6 kW	No	Fixed	12
8200076	Starter 38MT, 12V, CAT 3126, CAT C7, Blue Bird, 4.6 kW, No OCP, Fixed Nose, 10 Teeth	Caterpillar 3126; CAT C7	Blue Bird	12	4.6 kW	No	Fixed	10
8200005	Starter 38MT, 12V, DT466, IC Bus, 4.6 kW, No OCP, Fixed Nose, 12 Teeth	Navistar DT466	IC Bus (Navistar)	12	4.6 kW	No	Fixed	12
8200433	Starter 39MT, 12V, DT530, IC Bus, 7.2 kW, Yes OCP, Rotatable Nose, 12 Teeth	Navistar DT530	IC Bus (Navistar)	12	7.2 kW	Yes	Rotatable	12
8200007	Starter 38MT, 12V, T444E 7.3L, IC Bus, 4.6 kW, No OCP, Fixed Nose, 10 Teeth	Navistar T444E 7.3L	IC Bus (Navistar)	12	4.6 kW	No	Fixed	10
19011407	Starter 29MT, 12V, VT365, IC Bus, 3.3 kW, No OCP, Fixed Nose, 10 Teeth	Navistar VT365	IC Bus (Navistar)	12	3.3 kW	No	Fixed	10

Information & Images Provided by Delco Remy



STARTERS – LEECE-NEVILLE

Table 15-4: Starters - Leece-Neville

Part Number	Description	Engine	Popular Application	Volts	Output	Over Crank Protection	Nose (Fixed or Rotatable)	Teeth
M105312	Starter-Titan™ 105, 12V, Caterpillar C7, Blue Bird, Yes OCP, Fixed Nose, 12 Teeth	Caterpillar C7	Blue Bird # 0112173, CAT	12	5.0 kW	Yes	Fixed	12
M105612	Starter-Titan™ 105, 12V, Caterpillar C7, Blue Bird, No OCP, Rotatable Nose, 12 Teeth	Caterpillar C7	Blue Bird # 00074299, CAT	12	5.0 kW	No	Rotatable	12
M105611	Starter-Titan™ 105, 12V, Caterpillar C7, Blue Bird, No OCP, Rotatable Nose, 10 Teeth	Caterpillar C7	Blue Bird #0116126, CAT	12	5.0 kW	No	Rotatable	10
35259830S	Starter-M100R, 12V, Navistar DT-44E 7.3L, IC Bus, Yes OCP, Fixed Nose, 10 Teeth	Navistar DT-44E 7.3L	International 2508913C91, 2508912C91	12	4.0 kW	Yes	Fixed	10
35259840S	Starter-M100R, 12V, Navistar DT-44E 7.3L, IC Bus, No OCP, Fixed Nose, 10 Teeth	Navistar DT-44E 7.3L	International 2508913C91, 2508912C91	12	4.0 kW	No	Fixed	10
M105613	Starter-Titan™ 105, 12V, Cummins ISC, ISL, ISM, C7, C9, C10, C11, 3208, IC and MCI Bus, Yes OCP, Rotatable Nose, 12 Teeth	Cummins ISC, ISL, ISM, C7, C9, C10, C11, 3208	International Bus, MCI Bus	12	5.0 kW	Yes	Rotatable	12
M105602	Starter-Titan™ 105, 12V, Cummins ISC, ISL, ISM, C7, C9, C10, C11, 3208, IC and MCI Bus, No OCP, Rotatable Nose, 12 Teeth	Cummins ISC, ISL, ISM, C7, C9, C10, C11, 3208	International Bus, MCI Bus	12	5.0 kW	No	Rotatable	12
35262430	Starter-M101, 12V, Navistar 6.0L & 6.4L, Navistar Bus, No OCP, Rotatable Nose, 11 Teeth	Navistar 6.0L & 6.4L	Navistar	12	5.0 kW	No	Rotatable	11

Information & Images Provided by Leece-Neville



STARTERS – MITSUBISHI

Table 15-5: Starters - Mitsubishi

Part Number	Description	Engine	Popular Application	Volts	Output	Over Crank Protection	Nose (Fixed or Rotatable)	Teeth
1N1378	Starter 12V, DT466, DT530, HT570, IC Bus (after 1998), 5.5 kW, No OCP, Fixed Nose, 12 Teeth	Navistar DT466 / DT530 / HT570	International (1998-Current)	12	5.5 kW	No	Fixed	12
1N1378	Starter 12V, Navistar Maxx Force DT, 9, 10, IC Bus (after 1998), 5.5 kW, No OCP, Fixed Nose, 12 Teeth	Navistar Maxx Force DT, 9, 10	International (1998-Current)	12	5.5 kW	No	Fixed	12
MC2378	Starter 24V, Detroit Diesel DDS60, MCI Coach, 7.0 kW, No OCP, Fixed Nose, 11 Teeth	Detroit Diesel DDS60	MCI Coach (1998-Current)	24	7.0 kW	No	Fixed	11
MC2378	Starter 24V, Caterpillar C12, MCI Coach, 7.0 kW, No OCP, Fixed Nose, 11 Teeth	Caterpillar C12	MCI Coach (1998-2003)	24	7.0 kW	No	Fixed	11
MC2378	Starter 24V, Caterpillar C13 ACERT, MCI Coach, 7.0 kW, No OCP, Fixed Nose, 11 Teeth	Caterpillar C13 ACERT	MCI Coach (2004-Current)	24	7.0 kW	No	Fixed	11
MC2378	Starter 24V, Cummins ISM, MCI Coach, 7.0 kW, No OCP, Fixed Nose, 11 Teeth	Cummins ISM	MCI Coach (2007-Current)	24	7.0 kW	No	Fixed	11
PV2479	Starter 24V, Detroit Diesel DDS60, Prevost Coach, 7.0 kW, No OCP, Fixed Nose, 11 Teeth	Detroit Diesel DDS60	Prevost (1998-2009)	24	7.0 kW	No	Fixed	11

Information & Images Provided by Mitsubishi

BATTERIES - FEATURES & BENEFITS

COMMERCIAL STARTING AND AUTOMOTIVE BATTERIES

Feature	Advantage	What it does for you
650 - 1,150 cold cranking amps (CCA)	Up to 1,150 CCAs for reliable performance under most adverse weather conditions. As low as 650 CCAs for warmer climates where longevity is needed more than cranking power.	Can perform wherever you are located or required to go.
100% calcium alloy plate	Highest cranking capacity.	Longer shelf life.
Fully framed computer cast grids	Eliminates punctured separators.	Stronger/durable plate.
Anchor bonded	Improved vibration resistance.	Longer life in high vibration environments.

COMMERCIAL DUAL PURPOSE BATTERY

Feature	Advantage	What it does for you
Thicker plates	Allow for more frequent discharge and recharge of the battery.	Provides better cycling and longer life.
Dual-sided plate pasting	Increased paste weight.	Improves cycle life.
Fiberglass strands imbedded into plate surfaces	Locks active material to the plates, preventing shorts between the plates.	Can run accessories off of battery power for much longer.

COMMERCIAL ABSORBED GLASS MAT (AGM) BATTERY

Feature	Advantage	What it does for you
No free acid	Acid is absorbed by the separator material between the lead plates.	Non spillable. Safer to transport.
Tightly packed separators	More resistance to vibration	Improves cycle life.
Fiberglass strands imbedded into plate surfaces	Locks active material to the plates, preventing shorts between the plates	Better cycling than traditional battery design. Has a longer life.

BATTERIES (EXCLUDES MEXICO)

For Battery Terminals See pg. 15-14.



AGM, DUAL PURPOSE, & STARTING BATTERIES

- All batteries are Group 31, 12 Volt.



AGM Dual Purpose



Dual Purpose



Starting

Table 15-6: AGM, Dual Purpose & Starting Batteries – Excluding Mexico

Part Number	Description	Amp@ 0°C/32°F	Terminal Type	Terminal Location
BA31D81	Battery, AGM, Group 31, 12V, 800 Amps, Dual Terminal, Top Terminal Location	800	Dual	Top
BA31S121	Battery, AGM, Group 31, 12V, 1200 Amps, Stud Terminal, Top Terminal Location	1200	Stud	Top
BA31S92	Battery, AGM, Group 31, 12V, 925 Amps, Stud Terminal, Top Terminal Location	925	Stud	Top
BT31P111	Battery, Starting, Group 31, 12V, 1125 Amps, Post Terminal, Top Terminal Location	1125	Post	Top
BT31P61	Battery, Starting, Group 31, 12V, 650 Amps, Post Terminal, Top Terminal Location	650	Post	Top
BT31P71	Battery, Starting, Group 31, 12V, 760 Amps, Post Terminal, Top Terminal Location	760	Post	Top
BT31P91	Battery, Starting, Group 31, 12V, 925 Amps, Stud Terminal, Top Terminal Location	925	Post	Top
BT31S111	Battery, Starting, Group 31, 12V, 1125 Amps, Stud Terminal, Top Terminal Location	1125	Stud	Top
BT31S61	Battery, Starting, Group 31, 12V, 650 Amps, Stud Terminal, Top Terminal Location	650	Stud	Top
BT31S71	Battery, Starting, Group 31, 12V, 700 Amps, Stud Terminal, Top Terminal Location	700	Stud	Top
BT31S72	Battery, Starting, Group 31, 12V, 760 Amps, Stud Terminal, Top Terminal Location	760	Stud	Top
BT31S91	Battery, Starting, Group 31, 12V, 925 Amps, Stud Terminal, Top Terminal Location	925	Stud	Top
BD31S62	Battery, Dual Purpose, Group 31 - Heavy Duty, 12V, 650 Amps, Stud Terminal, Top Terminal Location	650	Stud	Top
BT31D61	Battery, Deep Cycle, Group 31, 12V, 650 Amps, Dual Terminal, Top Terminal Location	650	Dual	Top

BATTERIES (MEXICO ONLY)

STARTING BATTERIES

- All batteries are Group 31, 12 Volt.



BT31P75 / BT31P95



BT31S75 / BT31S95

Table 15-7: Starting Batteries – Mexico Only

Part Number	Description	Amp@0 °C/32 °F	Terminal Type
BT31P75	Battery, Group 31, 12V, 760 Amps, Post Terminal	760	Post
BT31P95	Battery, Group 31, 12V, 925 Amps, Post Terminal	925	Post
BT31S75	Battery, Group 31, 12V, 760 Amps, Stud Terminal	760	Stud
BT31S95	Battery, Group 31, 12V, 925 Amps, Stud Terminal	925	Stud

BATTERY CABLES

For Battery Accessories See pg. 15-18.



BATTERY CABLES

- Patented injection molded end for maintenance free cable connections.
- Universal end for crimping custom length cables.



Table 15-8: Battery Cables, Custom Crimp Cables

Part Number	Description	Length
BC2002	2/0 & 4/0 Cables - Positive-Red, 4'	4'
BC2000	2/0 & 4/0 Cables - Positive-Red, 8'	8'
BC2003	2/0 & 4/0 Cables - Positive-Red, 12'	12'
BC2004	2/0 & 4/0 Cables - Positive-Red, 16'	16'
BC2005	2/0 & 4/0 Cables - Positive-Red, 4'	4'
BC2006	2/0 & 4/0 Cables - Positive-Red, 8'	8'
BC2009	2/0 & 4/0 Cables - Positive-Red, 12'	12'
MS2010	2/0 & 4/0 Cables - Positive-Red, 16'	16'
BC2013	2/0 & 4/0 Cables - Positive-Black, 4'	4'
BC2012	2/0 & 4/0 Cables - Positive-Black, 8'	8'
BC2015	2/0 & 4/0 Cables - Positive-Black, 12'	12'
BC2016	2/0 & 4/0 Cables - Positive-Black, 16'	16'
BC2017	2/0 & 4/0 Cables - Positive-Black, 4'	4'
BC2018	2/0 & 4/0 Cables - Positive-Black, 8'	8'
BC2021	2/0 & 4/0 Cables - Positive-Black, 12'	12'
MS2022	2/0 & 4/0 Cables - Positive-Black, 16'	16'
BC3048	2/0 & 4/0 cables w/ 45" pigtails - Positive-Red, 4'	4'
BC3096	2/0 & 4/0 cables w/ 45" pigtails - Positive-Red, 8'	8'
BC4048	2/0 & 4/0 cables w/ 45" pigtails - Positive-Black, 4'	4'
BC4096	2/0 & 4/0 cables w/ 45" pigtails - Positive-Black, 8'	8'

Note: The stripped cable end is for illustration purposes only. Actual universal cable end will not come pre-stripped.

Bulk Battery Cable

- SGT: Cable is Thermoplastic insulated (PVC upper temp rating: 220° F/104° C).
- SGX: Cable is cross-linked (X) polyethylene insulated; same insulation thickness as SGT (PVC upper temp rating: 227° F/ 108° C).



Table 15-9: Battery Cables, Bulk

Part Number	Description	Gauge	Color
BC1206	Bulk Battery Cable - 25', 1/0 SGT	1/0 SGT	Black
BC1200	Bulk Battery Cable - 25', 2/0 SGT	2/0 SGT	Black
BC1205	Bulk Battery Cable - 25', 3/0 SGT	3/0 SGT	Black
BC1203	Bulk Battery Cable - 25', 4/0 SGT	4/0 SGT	Black

Part Number	Description	Gauge	Color
BC1004	Bulk Battery Cable - 250', 1/0 SGT	1/0 SGT	Black
BC1207	Bulk Battery Cable - 250', 3/0 SGT	3/0 SGT	Black
BC1030	Bulk Battery Cable - 250', 4/0 SGT	4/0 SGT	Black
BC1507	Bulk Battery Cable - 500', 1/0 SGX Flexstrand, Red	1/0 SGX Flexstrand	Red
BC1501	Bulk Battery Cable - 500', 1/0 SGX Flexstrand, Black	1/0 SGX Flexstrand	Black



Straight Ring Terminals

BATTERY TERMINALS

Table 15-10: Battery Cable Straight Ring Terminals

Part Number	Description	Gauge	Ring Terminal Diameter	Quantity/Pack
-------------	-------------	-------	------------------------	---------------

STRAIGHT RING TERMINALS

TM1623	Straight Ring Terminal, 1/0, 1/4" Diameter, 5 /pack	1/0	1/4"	5
TM1626	Straight Ring Terminal, 1/0, 3/8" Diameter, 5 /pack	1/0	3/8"	5
TM1629	Straight Ring Terminal, 1/0, 1/2" Diameter, 5 /pack	1/0	1/2"	5
TM1632	Straight Ring Terminal, 2/0, 1/4" Diameter, 5 /pack	2/0	1/4"	5
TM1575	Straight Ring Terminal, 2/0, 1/2" Diameter, 5 /pack	2/0	1/2"	5
TM1579	Straight Ring Terminal, 3/0, 1/4" Diameter, 5 /pack	3/0	1/4"	5
TM1580	Straight Ring Terminal, 3/0, 3/8" Diameter, 5 /pack	3/0	3/8"	5
TM1584	Straight Ring Terminal, 3/0, 1/2" Diameter, 5 /pack	3/0	1/2"	5
TM1635	Straight Ring Terminal, 4/0, 1/4" Diameter, 5 /pack	4/0	1/4"	5
TM1581	Straight Ring Terminal, 4/0, 3/8" Diameter, 5 /pack	4/0	3/8"	5
TM1583	Straight Ring Terminal, 4/0, 1/2" Diameter, 5 /pack	4/0	1/2"	5



90° Ring Terminals

Table 15-11: Battery Cable 90° Ring Terminals

Part Number	Description	Gauge	Ring Terminal Diameter	Quantity/Pack
-------------	-------------	-------	------------------------	---------------

90° RING TERMINALS

TM1638	90° Ring Terminal, 2/0, 3/8" Diameter, 5 /pack	2/0	3/8"	5
TM1578	90° Ring Terminal, 2/0, 1/2" Diameter, 5 /pack	2/0	1/2"	5

TM1582	90° Ring Terminal, 3/0, 3/8" Diameter, 5 /pack	3/0	3/8"	5
TM1585	90° Ring Terminal, 3/0, 1/2" Diameter, 5 /pack	3/0	1/2"	5
TM1641	90° Ring Terminal, 4/0, 3/8" Diameter, 5 /pack	4/0	3/8"	5
TM1586	90° Ring Terminal, 4/0, 1/2" Diameter, 5 /pack	4/0	1/2"	5



Elbow Ring Terminals

Table 15-12: Battery Cable Elbow Ring Terminals

Part Number	Description	Ring Diameter	Terminal Flag Orientation	Quantity/Pack
-------------	-------------	---------------	---------------------------	---------------

ELBOW RING TERMINALS

TM1595	Elbow Ring Terminal - 3/8" Diameter - Right Terminal Flag Orientation	3/8"	Right	5
TM1589	Elbow Ring Terminal - 3/8" Diameter - Left Terminal Flag Orientation	3/8"	Left	5
TM1591	Elbow Ring Terminal - 1/2" Diameter - Right Terminal Flag Orientation	1/2"	Right	5
MS1587	Elbow Ring Terminal - 1/2" Diameter - Left Terminal Flag Orientation	1/2"	Left	5
TM1596	Elbow Ring Terminal - 3/8" Diameter - Right Terminal Flag Orientation	3/8"	Right	5
TM1590	Elbow Ring Terminal - 3/8" Diameter - Left Terminal Flag Orientation	3/8"	Left	5
TM1599	Elbow Ring Terminal - 1/2" Diameter - Right Terminal Flag Orientation	1/2"	Right	5
TM1588	Elbow Ring Terminal - 1/2" Diameter - Left Terminal Flag Orientation	1/2"	Left	5
TM1598	Elbow Ring Terminal - 3/8" Diameter - Right Terminal Flag Orientation	3/8"	Right	5
TM1592	Elbow Ring Terminal - 3/8" Diameter - Left Terminal Flag Orientation	3/8"	Left	5
TM1600	Elbow Ring Terminal - 1/2" Diameter - Right Terminal Flag Orientation	1/2"	Right	5
TM1593	Elbow Ring Terminal - 1/2" Diameter - Left Terminal Flag Orientation	1/2"	Left	5



CABLE SPLICES

Table 15-13: Battery Cable Splices

Part Number	Description	Gauge	Quantity/Pack
-------------	-------------	-------	---------------

CABLE SPLICES

BC1644	Cable Splice - 1/0, 10 /pack	1/0	10
BC1601	Cable Splice - 2/0, 10 /pack	2/0	10
BC1602	Cable Splice - 3/0, 10 /pack	3/0	10
BC1604	Cable Splice - 4/0, 10 /pack	4/0	10



TAPERED POST CONNECTORS

Table 15-14: Battery Cables - Tapered Post Connectors, Straight Clamps

Part Number	Description	Gauge	Color	Quantity/ Pack
STRAIGHT CLAMPS				
TM1530	Straight Clamp, 2/0, Positive Polarity, 5 /pack	2/0	Red	5
TM1527	Straight Clamp, 2/0, NeGaugetive Polarity, 5 /pack	2/0	Black	5
TM1532	Straight Clamp, 3/0, Positive Polarity, 5 /pack	3/0	Red	5
TM1531	Straight Clamp, 3/0, NeGaugetive Polarity, 5 /pack	3/0	Black	5
TM1536	Straight Clamp, 4/0, Positive Polarity, 5 /pack	4/0	Red	5
TM1533	Straight Clamp, 4/0, NeGaugetive Polarity, 5 /pack	4/0	Black	5



Table 15-15: Battery Cables - Tapered Post Connectors, Elbow Clamps

Part Number	Description	Gauge	Color	Orientaion	Quantity/ Pack
ELBOW CLAMPS					
TM1650	Elbow Clamp, 2/0, Positive, Right Orientation	2/0	Red	Right	5
TM1647	Elbow Clamp, 2/0, Negative, Right Orientation	2/0	Black	Right	5
TM1656	Elbow Clamp, 2/0, Positive, Left Orientation	2/0	Red	Left	5
TM1653	Elbow Clamp, 2/0, Negative, Left Orientation	2/0	Black	Left	5
TM1655	Elbow Clamp, 3/0, Positive, Right Orientation	3/0	Red	Right	5
TM1662	Elbow Clamp, 4/0, Negative, Right Orientation	4/0	Black	Right	5



For Batteries See pg. 15-11.



Table 15-16: Battery Cables - Tapered Post Connectors, Flag Clamps

Part Number	Description	Gauge	Color	Quantity/ Pack
FLAG CLAMPS				
TM1539	Flag Clamp, 2/0, Positive, 5 /pack	2/0	Red	5
TM1542	Flag Clamp, 2/0, Negative, 5 /pack	2/0	Black	5
TM1545	Flag Clamp, 4/0, Positive, 5 /pack	4/0	Red	5
TM1548	Flag Clamp, 4/0, Negative, 5 /pack	4/0	Black	5



Table 15-17: Battery Cables - Tapered Post Connectors, Universal Straight Clamps

Part Number	Description	Gauge	Color	Quantity/ Pack
STRAIGHT CLAMPS - UNIVERSAL COMPRESSION				
TM1696	Straight Clamp Universal Compression, 2/0, Universal, 5 /pack	2/0	Universal	5
TM1699	Straight Clamp Universal Compression, 4/0, Universal, 5 /pack	4/0	Universal	5



END PROTECTORS, TUBING & ACCESSORIES

Table 15-18: Battery Cables - End Protectors, Tubing & Accessories, Battery Cable Nut Caps

Part Number	Description	Gauge	Polarity	Color	Quantity/ Pack
BATTERY CABLE NUT CAPS					
BC6924	Battery Cable Nut Cap, 1/0 - 4/0, Positive, Red, 5 /pack	1/0 - 4/0	Positive	Red	5
BC6911	Battery Cable Nut Cap, 1/0 - 4/0, NeGaugetive, Black, 5 /pack	1/0 - 4/0	Negative	Black	5

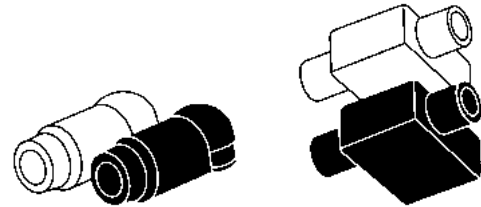


Table 15-19: Battery Cables - End Protectors, Tubing & Accessories, Clamp Protectors

Part Number	Description	Gauge	Color	Quantity/ Pack
STRAIGHT CLAMP PROTECTORS				
MS1561	Straight Clamp Protector, 1/0 - 2/0, Red, 5 /pack	1/0 - 2/0	Red	5
MS1557	Straight Clamp Protector, 1/0 - 2/0, Black, 5 /pack	1/0 - 2/0	Black	5

FLAG CLAMP PROTECTORS

MS1685	Flag Clamp Protector, 1/0 - 2/0, Red, 5 /pack	1/0 - 2/0	Red	5
MS1683	Flag Clamp Protector, 1/0 - 2/0, Black, 5 /pack	1/0 - 2/0	Black	5

HEAVY DUTY STARTER PROTECTORS

MS1564	Heavy Duty Starter Protector, 1/0 - 2/0, Red, 5 /pack	1/0 - 2/0	Red	5
MS1567	Heavy Duty Starter Protector, 1/0 - 2/0, Black, 5 /pack	1/0 - 2/0	Black	5

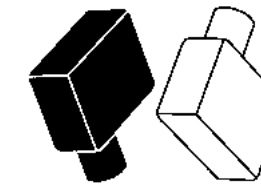


Table 15-20: Battery Cables - End Protectors, Tubing & Accessories, Elbow Clamp Protectors

Part Number	Description	Gauge	Color	Orientation	Quantity/ Pack
ELBOW CLAMPS PROTECTORS					
MS1680	Elbow Clamp Protector, 1/0 - 2/0, Red, Right Orientation, 5 /pack	1/0 - 2/0	Red	Right	5
MS1674	Elbow Clamp Protector, 1/0 - 2/0, Red, Left Orientation, 5 /pack	1/0 - 2/0	Red	Left	5
MS1677	Elbow Clamp Protector, 1/0 - 2/0, Black, Right, Orientation, 5 /pack	1/0 - 2/0	Black	Right	5
MS1671	Elbow Clamp Protector, 1/0 - 2/0, Black, Left Orientation, 5 /pack	1/0 - 2/0	Black	Left	5



Table 15-21: Battery Cables - End Protectors, Tubing & Accessories, Cable Clamp Heat Shrink

Part Number	Description	Gauge	Color	Quantity/ Pack
BATTERY CABLE CLAMPS - HEAT SHRINK				
MS1554	Battery Cable End - Heat Shrink, 1/0 - 4/0, Red, 10 /pack	1/0 - 4/0	Red	10
MS1551	Battery Cable End - Heat Shrink, 1/0 - 4/0, Black, 10 /pack	1/0 - 4/0	Black	10



Table 15-22: Battery Cables - End Protectors, Tubing & Accessories, Split Loom (Convoluted Tubing)

Part Number	Description	Inside Diameter	Package	Length
SPLIT LOOM (CONVOLUTED TUBING)				
MS1519	Split Loom, 1/4" Inside Diameter, EZ-pull box, 100'	1/4"	EZ-pull box	100'
MS1522	Split Loom, 3/8" Inside Diameter, EZ-pull box, 100'	3/8"	EZ-pull box	100'
MS1525	Split Loom, 1/2" Inside Diameter, EZ-pull box, 100'	1/2"	EZ-pull box	100'
MS1528	Split Loom, 5/8" Inside Diameter, EZ-pull box, 100'	5/8"	EZ-pull box	100'
MS1531	Split Loom, 3/4" Inside Diameter, EZ-pull box, 100'	3/4"	EZ-pull box	100'
MS1534	Split Loom, 1" Inside Diameter, EZ-pull box, 100'	1"	EZ-pull box	50'
D6011-1336	Split Loom, 1" Inside Diameter, Bulk, 300'	1"	Bulk	300'
MS1338	Split Loom, 1-1/4" Inside Diameter, Bulk, 250'	1-1/4"	Bulk	250'

NEGATIVE BATTERY CABLES

- Crimped terminal connections do not corrode like a soldered connection.
- Injection molded ends bond to the wire insulation to keep moisture out.
- Optimizes electrical conductivity.

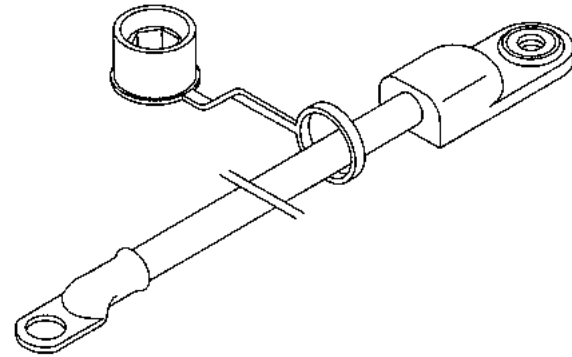


Table 15-23: Battery Cables - Negative Cables

Part Number	Description	Gauge	Length	End 2 Ring Diameter
NEGATIVE BATTERY CABLES				
BC1727	Negative Battery Cable, 2/0, 25", 3/8" Ring Diameter for End 2	2/0	25"	3/8"
BC12821	Negative Battery Cable, 2/0, 25", 1/2" Ring Diameter for End 2	2/0	35"	1/2"
MS1310	Negative Battery Cable, 2/0, 90", 1/2" Ring Diameter for End 2	2/0	90"	1/2"
BC1611	Negative Battery Cable, 4/0, 126", 3/8" Ring Diameter for End 2	4/0	126"	1/2"

SWITCHES



ASSORTED SWITCHES

Table 15-24: Switches – Assorted

Part Number	Description
BA31100	Blower Switch
BA40100	Cover, Toggle Switch, Keyway Tab Opposite Hinged End
BA21050	Dimmer Switch, 3 Blade Terminals, Replaces Delco 1997021 and D-800; Motorcraft SW-257
BA40300	Door Control Plug
BL11100	Junction Block
FR10080	Lockout Bracket
BA31000	Potentiometer Switch
BA29050	Reverse Switch
BA29100	Reverse Switch
BA29150	Reverse Switch
BA29200	Reverse Switch
BA40150	Switch Cover
BA40050	Switch Knob, Chrome
BA40250	Toggle Switch Boot
BA40200	Switch Boot
BA50250	Wiper/Washer Switch, Electronic Solid State, w/ Dynamic Parking, One Motor, Delphi (Packard), 12V DC

PRESSURE SWITCHES

Table 15-25: Switches – Pressure

Part Number	Description
BA26850	Low Pressure Switch
BA26900	Low Pressure Switch 70 psi
BA26600	Oil Pressure Switch, 15 psi
BA26650	Oil Pressure Switch, 4 psi
BA26550	Oil Pressure Switch, 6 psi
BA25400	Pressure Indicator Switch
BA24050	Pressure Switch
BA25450	Pressure Switch
BA26700	Pressure Switch, 6 psi
BA26750	Pressure Switch, 8 psi

PUSH BUTTON SWITCHES

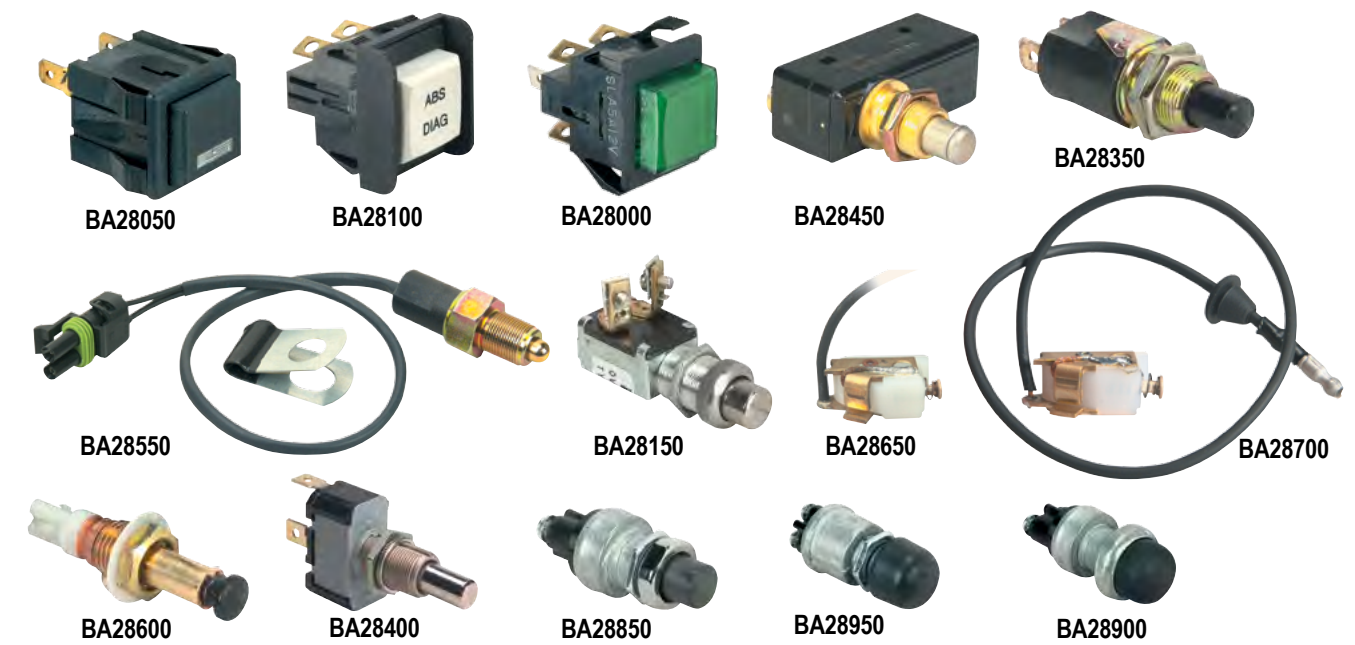


Table 15-26: Switches – Push Button

Part Number	Description
DASH SWITCHES	
BA28050	A/C Compressor Switch
BA28100	ABS Diagnostic Switch
BA28000	Diagnostic Switch
DOOR/COURTESY LAMP SWITCHES	
BA28350	Courtesy Light Switch
BA28600	Door Jamb Switch
BA28650	Door Light Switch
BA28700	Door Light Switch
BA28400	Push Button Switch, Door
MISCELLANEOUS SWITCHES	
BA28150	Manual Override Switch
BA28550	Push Button Switch, Assembly
BA28450	Push Button Switch, Clutch
MOMENTARY START SWITCHES	
BA28850	Momentary Start Switch, 60 amp at 12v, Silver Contacts, Housing Rolled Over Insulator to Seal Out Dust and Moisture
BA28950	Momentary Start Switch, Extra Heavy Duty, 2 Screw Terminals
BA28900	Switch, 60amp at 12V, Weather and Dust Proof, Plastic Push Button, 2 Screw Terminals

ROCKER SWITCHES

Table 15-27: Switches – Rocker

Part Number	Description
BA30200	Bunk Heater Rocker Switch
BA32150	Micro Roller Switch
BA30650	Rocker Switch 3 Position
BA30600	Rocker Switch, 2 Position (On/Off)
BA30250	Rocker Switch, Dome Light
BA30400	Rocker Switch, Dome Light, 2 Position
BA30550	Rocker Switch, On/Off
BA30700	Rocker Switch, On/Off
BA30450	Rocker Switch, Refrigerator Fan
BA30500	Rocker Switch, SPST (On/Off)
BA30300	On-Off



BA30500

BA30450

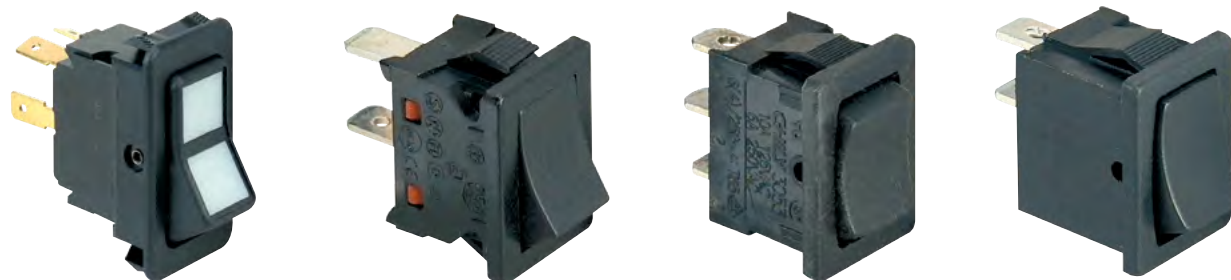


BA30250

BA30300

BA30400

BA30550



BA30200

BA30700

BA30650

BA30600

TOGGLE SWITCHES

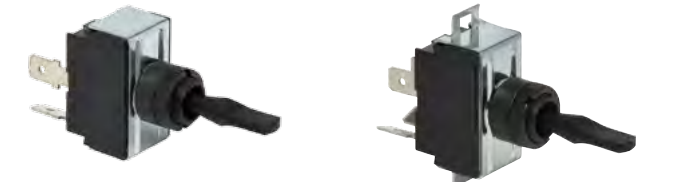
Table 15-28: Switches – Toggle

Part Number	Description
BA34200	Paddle Toggle Switch, No Bracket, DPST On-MOM, Up: On, Center: Off, Down: On, 4 Blade Terminals, Silver Contacts, 15/32-32 Mounting Stem, Includes Mounting Hardware: Black Knurled Facenut, Hexnut, 1" (25.4mm) Handle, Black Plastic, Matte Finish, 25A, 12V
BA34250	Paddle Toggle Switch, No Bracket, DPST On-Off Up: On, Center: Off, 4 Blade Terminals, Silver Contacts, 15/32-32 Mounting Stem, Includes Mounting Hardware: Black Knurled Facenut, Hexnut, 1" (25.4mm) Handle, Black Plastic, Matte Finish, 25A, 12V DC.
BA34350	Paddle Toggle Switch, No Bracket, SPST On-Off Up: On, Center: Off, 2 Blade Terminals, Silver Contacts, 15/32-32 Mounting Stem, Includes Mounting Hardware: Black Knurled Facenut, Hexnut, 1" (25.4mm) Handle, Black Plastic, Matte Finish, 25A, 12V DC.
BA33600	Paddle Toggle Switch, w/ Bracket DPDT On-Off, Up: On, Center: Off, 4 Blade Terminals, Silver Contacts, 15/32-32 Mounting Stem, Includes Mounting Hardware: Black Knurled Facenut, Hexnut, 1" (25.4mm) Handle, Black Plastic, Matte Finish, 25A, 12V DC.
BA33750	Paddle Toggle Switch, w/ Bracket DPST On-Off-On, Up: On, Center: Off, Down: On, 6 Blade Terminals, Silver Contacts, 15/32-32 Mounting Stem, Includes Mounting Hardware: Black Knurled Facenut, Hexnut, 1" (25.4mm) Handle, Black Plastic, Matte Finish, 25A, 12
BA33550	Paddle Toggle Switch, w/ Bracket SPDT On-Off-On, Up: On Center: Off, Down: On, 3 Blade Terminals, Silver Contacts, 15/32-32 Mounting Stem, Includes Mounting Hardware: Black Knurled Facenut, Hexnut, 1" (25.4mm) Handle, Black Plastic Matte Finish, 25A, 12V
BA33650	Switch
BA34800	Toggle Switch
BA34950	Toggle Switch
BA11800	Toggle Switch, 12v, Blower
BA34600	Toggle Switch, 2 Terminals
BE10350	Toggle Switch, DPDT
BA34300	Toggle Switch, SPDT, 3 Terminal
BA33500	Toggle Switch, SPST (On/Off), 2 Terminals
BA34850	Toggle Switch, SPST (On/Off), w/ Wires
BA13250	Toggle Switch, SPST, (On-Non-Off)



BA34200

BA34250



BA34350

BA33600



BA33750

BA33550



BA13250

BA34800



BA34950

BA11800



BA34600

BA33500



BA34850

CONNECTORS



CONNECTOR BODIES/SHELLS

Table 15-29: Connector Bodies & Shells

Part Number	Description	Type	Size (mm)
1 WIRE			
CN10250	Dill 90 Deg., 10 Stud	1 Wire	
CN10400	Female, Deutsch, 12-14 AWG	1 Wire	
CN10350	Female, Deutsch, 8-10 AWG	1 Wire	
CN10300	Female, Deutsch, 6 AWG	1 Wire	
CN10150	Deutsch 12-14 AWG	1 Wire	
CN10050	Deutsch 6 AWG	1 Wire	
CN10100	Deutsch 8-10 AWG	1 Wire	
CN10450	Female, Packard 56 Series	1 Wire	
CN10550	Male, Packard 56 Series	1 Wire	
CN10500	Female, Packard Weather Pack Tower	1 Wire	20.8 x 40.5 x 13.6
CN10600	Male, Packard Weather Pack Shroud	1 Wire	17.3 x 45.1 x 16.5



For Connector Tools See pg. 15-54.



Part Number	Description	Type	Size (mm)
-------------	-------------	------	-----------

2 WIRE

CN10900	Female, Packard Metri-Pack 150 Series	2 Wire	18.6 x 26 x 23
CN10850	Female, Packard Metri-Pack 150 Series	2 Wire	18.4 x 27.1 x 16
CN10750	Female, Packard Metri-Pack 150 Series	2 Wire	17.3 x 21.4 x 12.5
CN11300	Male, Packard Metri-Pack 280 Series	2 Wire	22 x 40 x 17.3
CN11250	Male, Packard Metri-Pack 280 Series	2 Wire	20 x 53 x 25.2
CN11100	Female, Packard Weather Pack Tower	2 Wire	20.8 x 40.8 x 21.5
CN11350	Male, Packard Weather Pack Shroud	2 Wire	17.5 x 47 x 23.9
CN10950	Female, Packard Metri-Pack 150 Series	2 Wire	18.6 x 26 x 23
CN10800	Female, Packard Metri-Pack 150 Series	2 Wire	18.3 x 26 x 23
CN10650	Female, Packard 56 Series	2 Wire	
CN11150	Male, Metri-Pack 480 Series	2 Wire	24.5 x 53 x 30.5
CN10700	Female, Packard 56 Series	2 Wire	
CN11000	Female, Packard Metri-Pack 280 Series	2 Wire	25 x 29.9 x 25.2
CN11200	Male, Packard 56 Series	2 Wire	





CN11750



CN11900



CN11850



CN11650



CN11600



CN11700



CN11550



CN11450



CN11400



CN11800



CN11550

Part Number	Description	Type	Size (mm)
-------------	-------------	------	-----------

3 WIRE

CN11700	Female, Packard Metri-Pack 280 Series	3 Wire	33.2 x 30.9 x 37.3
CN11800	Male, Metri-Pack 630 Series	3 Wire	
CN11850	Male, Packard 56 Series	3 Wire	
CN11900	Male, Packard Weather Pack Shroud	3 Wire	19.2 x 47 x 32.1
CN11550	Dill	3 Wire	
CN11650	Female, Packard 56 Series	3 Wire	
CN11600	Female, 59 Series	3 Wire	
CN11500	Deutsch	3 Wire	
CN11450	Deutsch	3 Wire	
CN11400	Deutsch	3 Wire	
CN11750	Female, Packard Weather Pack Tower	3 Wire	21 x 40.5 x 29.5



CN12050



CN12000



CN12250



CN11950



CN11550



CN12350



CN12400

Part Number	Description	Type	Size (mm)
-------------	-------------	------	-----------

4 WIRE

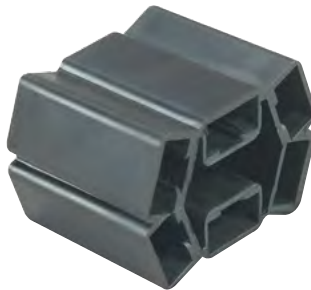
CN12150	Female, Packard Metri-Pack 280 Series	4 Wire	25 x 29.9 x 48.3
CN12400	Packard Weather Pack	4 Wire	17.1 x 46.7 x 39.5
CN12250	Female, Packard Weather Pack Tower	4 Wire	21 x 40.5 x 37.1
CN12350	Packard Weather Pack	4 Wire	24.9 x 47 x 24.1
CN11950	Packard 56 Series	4 Wire	
CN12000	Female, Packard 56 Series	4 Wire	
CN12050	Female, Packard 56 Series	4 Wire	



CN12700



CN12650



CN12450



CN12500



CN12550

Part Number	Description	Type	Size (mm)
-------------	-------------	------	-----------

5 WIRE

CN12700	Packard 56 Series	5 Wire	17 x 25 x 33
CN12450	56 series, Unscaled Female Connector	5 Wire	
CN12550	Female, Packard Metri-Pack 280 Series	5 Wire	41.5 x 30.6 x 35.5
CN12650	Male, Packard Metri-Pack 280 Series	5 Wire	23.8 x 53 x 49.6
CN12500	Female, Packard Metri-Pack 280 Series	5 Wire	25 x 29.9 x 48.3



CN12600



CN13350



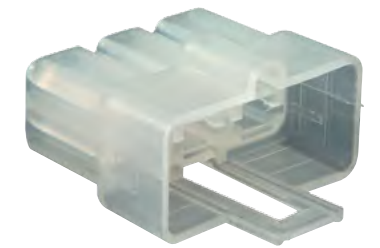
CN12800



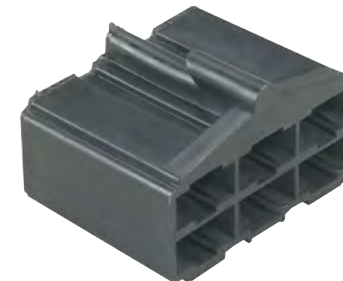
CN12900



CN13100



CN13250



CN13050



CN13000



CN13200



CN12950



CN12750

Part Number	Description	Type	Size (mm)
-------------	-------------	------	-----------

6 WIRE

CN12900	Female, Micro-Pack 100 Series	6 Wire	12.9 x 22.7 x 18.7
CN12600	Female, Packard Weather Pack Tower	6 Wire	23.5 x 39.1 x 52.1
CN12800	Data Bus Connector	6 Wire	
CN12750	(Amp) Locking Connector	6 Wire	
CN13250	Male, Packard 56 Series	6 Wire	
CN13200	Male, Packard 56 Series	6 Wire	
CN13000	Female, Packard 56 Series	6 Wire	
CN12950	Female, Packard 56 Series	6 Wire	20.3 x 25.4 x 33
CN13100	Female, Packard 58 Series	6 Wire	
CN13350	Male, Packard Weather Pack Shroud	6 Wire	20.7 x 46.2 x 55.5
CN13050	Female, Packard 56 Series	6 Wire	



CN13500



CN13650



CN13950



CN13600



CN14050



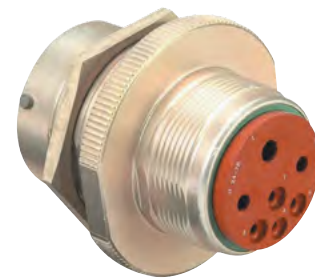
CN14000



CN13800



CN13700



CN13400



CN13750

Part Number	Description	Type	Size (mm)
-------------	-------------	------	-----------

ADDITIONAL WIRE SIZES

CN13400	Deutsch	7 Wire	
CN15400	PD Box	7-Way	
CN13500	Male, Packard Metri-Pack 280 Series	8 Wire	25.6 x 40 x 26.5
CN13550	9 Wire, Amp	9 Wire	
CN13600	Female, Packard 56 series	9 Wire	
CN13650	Molex	12 Wire	
CN13700	Deutsch	14 Wire	
CN13750	Deutsch	14 Wire	
CN13800	Deutsch	14 Wire	
CN15050	Deutsch	Deutsh	
CN13950	Molex	16 Wire	
CN14000	Male, Metri-Pack Mixed	17 Wire	28.8 x 46.6 x 63.8
CN14050	Molex	18 Wire	
CN14150	Packard Weather Pack Natural	22 Wire	65 x 47.7 x 55.2



CN14500



CN14350



CN14300



CN14750



CN14450



CN14400



CN14150



CN14800



BL10850

Part Number	Description	Type	Size (mm)
BL10850	Packard	25 Wire	
CN13850	Packard, MP 280 Series	Packard 280 Series	
CN12300	Packard, MP 280 Series	Packard 280 Series	
CN13900	Packard, MP 280 Series	Packard 280 Series	
CN13300	Packard, MP 280 Series	Packard 280 Series	
CN14800	Plug	Plug	
CN60900	Lamp Socket	Socket	
CN15500	Connector Wire Harness	Harness	
CN14850	Connector Terminal Spacer	Terminal	
CN14450	Deutsch	31 Wire	
CN14350	Deutsch	31 Wire	
CN14500	Deutsch	31 Wire	
CN14400	Deutsch	31 Wire	
CN14300	Deutsch	31 Wire	
CN14600	Yazaki	40 Wire	
CN14650	Yazaki	40 Wire	
CN14550	Ladd	40 Wire	
CN14750	Deutsch	47 Wire	
CN60050	Speaker Adapter	Adapter	
CN60100	Adapter		

CIRCUIT BREAKERS, FUSES, & RELAYS

UNIVERSAL CIRCUIT BREAKER FOR ATC®/ATO® BLADE TYPE FUSES

- SAE Type 1, Automatic Reset
Cycles or continuously resets until the fault is corrected; Typically used to protect circuits that occasionally experience momentary overloads such as wiper motor and headlamp circuits.
- SAE Type 2, Automatic Reset
SAE Type 1, Automatic Reset position while there is power to the circuit; Resets when ignition is turned off; Typically used in applications where fuse replacement is objectionable, such as power window, seat, and sunroof circuits.
- SAE Type 3, Automatic Reset
Manually resettable circuit breakers remain in the open position until a button, lever, or other external reset device is manually depressed; Typically used in applications where a manual reset is desired for safe diagnosis of a circuit fault; Snap-off terminals for greater flexibility
- Voltage Rating: 12V DC
- Approvals: Complies with SAE J553C

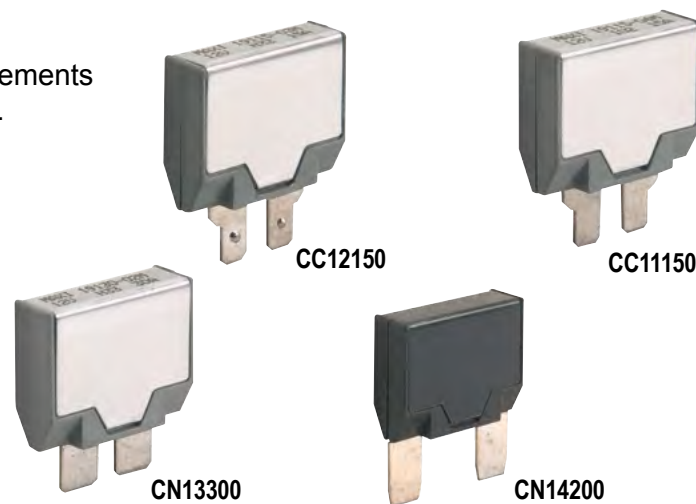
Table 15-30: Fuses – Universal CB for ATC®/ATO® Blade Type Fuses

Part Number	Amp
CC15100	10
CC15150	15
CC15200	20
CC15250	25
CC15300	30



PLUG-IN CIRCUIT BREAKERS

- Plug-in circuit breakers can be used as replacements for MAXI™, ATC®, and ATO® blade-type fuses.
- Metal cover aids in heat dissipation
- SAE Type 1, Automatic Reset
- Voltage Rating: 12V DC
- Operating Temperature: -20° F to +150° F
- Approvals: Complies with SAE J553



For Terminal Bus Bars See pg. 15-47.

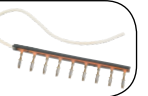


Table 15-31: Circuit Breakers - Plug-In

Part Number	Amp
-------------	-----

LONG ATC™/ATO™ TERMINAL TYPE

CC11050	5
CC11080	8
CC11100	10
CC11150	15
CC1120PLE0	20
CC11250	25
CC11300	30

LONG ATC™/ATO™ TERMINAL TYPE WITH LOCKING DIMPLES

CC12050	5
CC12080	8
CC12100	10
CC12150	15
CC12250	25
CC12300	30

MAXI™ TERMINAL TYPE

CC14200	20
CC14250	25
CC14300	30
CC14350	35
CC14400	40
CC14500	50

WIDE ATC™/ATO™ TERMINAL TYPE

CC13050	5
CC13080	8
CC13100	10
CC13150	15
CC13200	20
CC13250	25
CC13300	30
CC13350	35
CC13400	40

STUD TERMINAL CIRCUIT BREAKERS

- 10-32 0.56" studs
- SAE Type 1, Automatic Reset
- Voltage Rating: 12V DC
- Operating Temp: -10° F to +150° F
- Approvals: Complies with SAE J553

Table 15-32: Stud Terminal Circuit Breakers

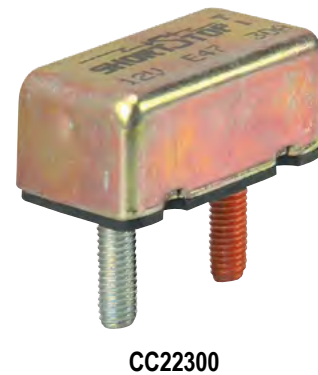
Part Number	Amp
STUD & MOUNTING BRACKET	
CC23050	5
CC23080	8
CC23100	10
CC23150	15
CC23200	20
CC23250	25
CC23300	30
CC23400	40

STUD AND BLADE TERMINALS

CC24100	10
CC24150	15
CC24200	20
CC24250	25
CC24300	30
CC24400	40

STUD TERMINALS

CC22050	5
CC22080	8
CC22100	10
CC22150	15
CC22200	20
CC22250	25
CC22300	30
CC22400	40



THERMAL CIRCUIT BREAKERS

- Thermal circuit breakers use a thermal sensing element system to sense overload conditions and interrupt the flow of current.

Table 15-33: Thermal Circuit Breakers

Part Number	Amp
BLADE W/ SCREW TERMINALS	
CC33150	15
CC33200	20
CC33250	25
CC33300	30
CC33350	35
CC33400	40

SNAP-IN MOUNTING

CC32100	10
CC32150	15
CC32200	20
CC32300	30
CC32350	35

STUD TERMINAL MOUNTING

CC30350	35
CC30400	40
CC30450	45
CC30500	50
CC30600	60
CC30700	70
CC30800	80
CC30900	90
CC31050	105
CC31200	120
CC31350	135
CC31500	150



RELAYS

Table 15-34: Electrical Relays

Part Number	Description
CB13650	24-Volt Relay
CB12800	3-Screw Terminals, 3-Hole Bracket
CB12750	4-Prong, High AMP
CB12300	5-Prong
CB12250	5-Prong Relay, Micro ISO
CB12900	5-Prong w/ Bracket
CB12450	5-Prong w/ Cover & Bracket
CB12200	6-Prong
CB12100	Power Accessory Relay, 2 Prong, 2 Terminals
CB13550	Relay
CB13600	Switch Relay
CB12650	Relay, 5 Prong
CB12850	Relay, 5 Prong
CB13500	Relay, 5 Prong, 50amp, w/ Bracket



CB13500



BA12850



CB12800



CB12300



CB12650



CB12100



CB12900



CB12750



CB12200



CB12450



CB12250

RELAY BLOCKS AND FUSE BLOCKS

Table 15-35: Relay Blocks and Fuse Blocks

Part Number	Description
BL10650	10 Terminals
BL10500	2 Terminals
BL10800	5 Terminals
BL10450	5 Terminals
BL10250	ATO Fuse Module
BL10750	2-Position Fuse
CN60500	4-Position Fuse
BL10400	Fuse, 2 Position
BL10550	Fuse, 5 Position
BL10300	High Current Relay
BL10950	Maxi/Mini/Micro
BL11150	Power Relay Module
BL10350	Module
BL10700	Module/Drawer
BL10600	Module/Storage
BL10050	Block Terminal



BL10550



BL10650



BL10700



BL10600



BL10950



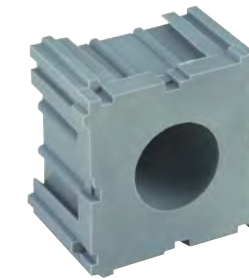
BL10800



BL10450



BL10400



BL10350



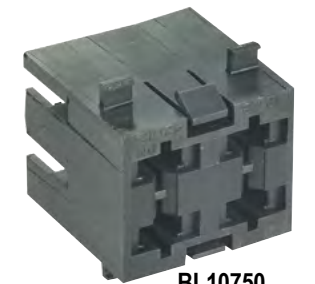
BL10050



BL10300



BL10250



BL10750

FLASHERS

FLASHERS

- Meets or exceeds FMVSS 108 and SAE J945 and J590
- Fits all standard turn signal sockets
- Electronic chip improves flashing and extends flasher life
- Available in two- or three-terminal models

Table 15-36: Electrical Flashers

Part Number	Description
CB12050	2-Prong
CB12700	2-Prong w/ Bracket
CB12150	3-Prong



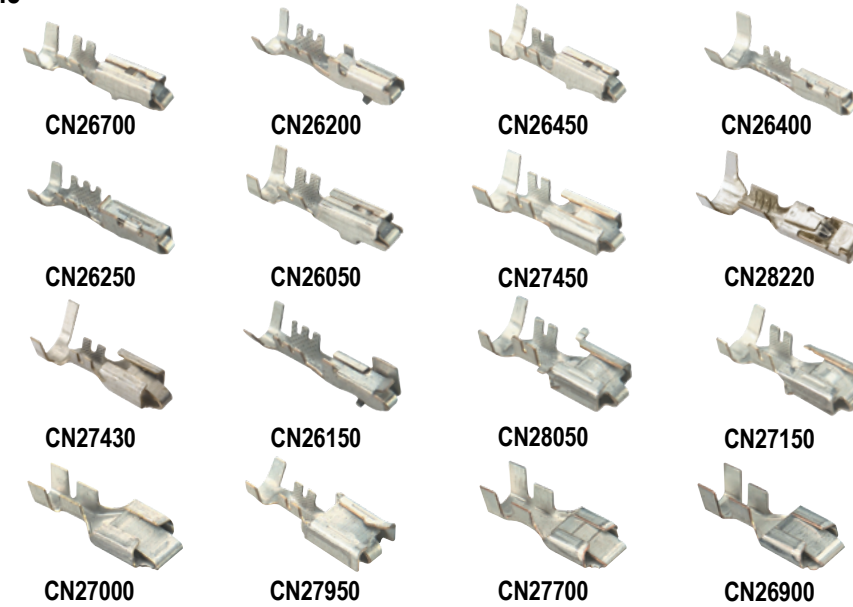
CB12150



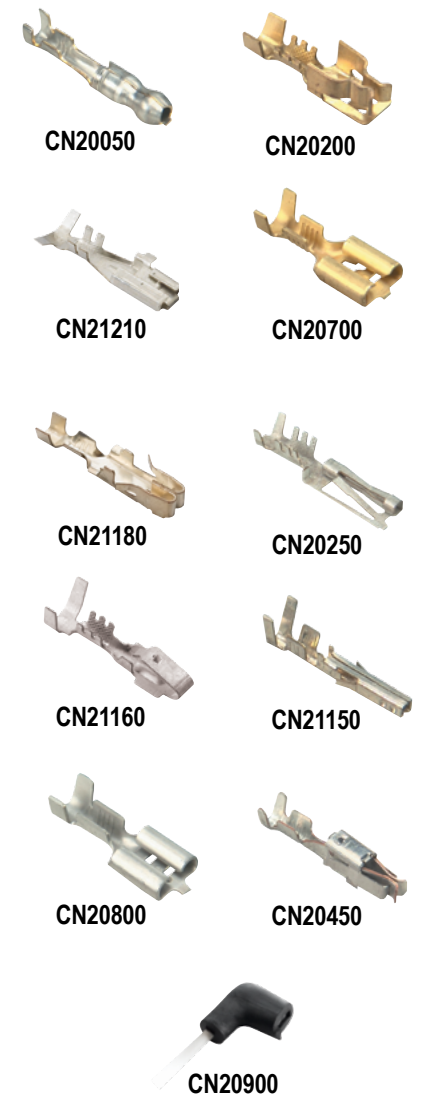
CB12050

WIRE CONNECTORS

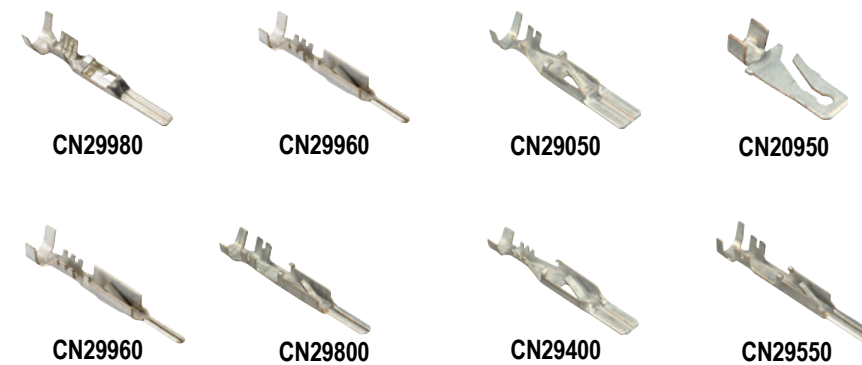
Female



Misc. Terminal Ends



Male



TERMINAL ENDS - SPADE/SLIDE

Table 15-37: Connectors: Terminal Ends - Spade/Slide

Part Number	Description	Mates With	Type
FEMALE			
CN26200	16-18 Gauge		Packard 150 Series
CN26250	16-18 Gauge		Packard 150 Series
CN26300	20-22 Gauge		Packard 150 Series
CN26350	24 Gauge		Packard 150 Series
CN26400	16-20 Gauge		Packard 150 Series, Sealed
CN26410	20-22 Gauge	CN29960	Packard 150 Series, Sealed
CN26160	16-18 Gauge		Packard 150.2 Series

Part Number	Description	Mates With	Type
CN26150	20-22 Gauge		Packard 150.2 Series
CN26450	12 Gauge	CN29550	Packard 280 Series, Sealed
CN26500	12-14 Gauge	CN25650	Packard 280 Series, Sealed
CN26550	16-18 Gauge	CN29650	Packard 280 Series, Sealed
CN26600	20-22 Gauge	CN29700	Packard 280 Series, Sealed
CN26030	10-12 Gauge	CN29550	Packard 280 Series, Tangleless
CN26050	12-14 Gauge	CN25660	Packard 280 Series, Tangleless
CN26100	16-18 Gauge	CN25320	Packard 280 Series, Tangleless
CN26650	10-12 Gauge	CN29750	Packard 280 Series, Unsealed
CN26700	12-14 Gauge	CN29800	Packard 280 Series, Unsealed
CN26750	14-16 Gauge	CN29850	Packard 280 Series, Unsealed
CN26800	18-20 Gauge	CN29900	Packard 280 Series, Unsealed
CN27430	14-16 Gauge	CN29520	Packard 480 Series, Sealed
CN27450	10 Gauge	CN29250	Packard 480 Series, Sealed
CN27500	12 Gauge	CN29300	Packard 480 Series, Sealed
CN27550	14-16 Gauge	CN29350	Packard 480 Series, Sealed
CN27570	14-16 Gauge, Brass	CN29350	Packard 480 Series, Sealed
CN27600	18 Gauge	CN29400	Packard 480 Series, Sealed
CN27650	20-22 Gauge	CN29450	Packard 480 Series, Sealed
CN27700	10 Gauge	CN20950	Packard 56 Series, Unsealed
CN27750	12 Gauge, w/ Nib	CN21000	Packard 56 Series, Unsealed
CN27760	14-16 Gauge	CN21050	Packard 56 Series, Unsealed
CN26950	12 Gauge	CN21000	Packard 56 Series, Unsealed
CN26900	12 Gauge, w/ Rib	CN20950 or CN21000	Packard 56 Series, Unsealed
CN26960	14-16 Gauge	CN21050	Packard 56 Series, Unsealed
CN27000	14-16 Gauge	CN21050	Packard 56 Series, Unsealed
CN27050	14-16 Gauge (2 Each)		Packard 56 Series, Unsealed
CN27800	14-16 Gauge, w/ Nib	CN21050	Packard 56 Series, Unsealed
CN27100	14-16 Gauge, w/ Nib (2 each)		Packard 56 Series, Unsealed
CN27810	18-20 Gauge	CN21100	Packard 56 Series, Unsealed
CN27850	18-20 Gauge, w/ Nib	CN21100	Packard 56 Series, Unsealed
CN27150	10-12 Gauge	CN29050	Packard 630 Series, Unsealed
CN27400	10-12 Gauge (2 each)		Packard 630 Series, Unsealed
CN27200	12 Gauge	CN29100	Packard 630 Series, Unsealed
CN27250	14-16 Gauge	CN29150	Packard 630 Series, Unsealed
CN27300	18-20 Gauge	CN29200	Packard 630 Series, Unsealed
CN27350	20-22 Gauge		Packard 630 Series, Unsealed
CN28000	10-12 Gauge	CN29050	Packard 630 Series, Unsealed
CN27950	14-16 Gauge	CN29150	Packard 630 Series, Unsealed
CN27900	18 Gauge	CN29200	Packard 630 Series, Unsealed
CN28050	10-12 Gauge	BL10800	Packard 630 Spec. Series, Unsealed
CN28100	14-16 Gauge	BL10800	Packard 630 Spec. Series, Unsealed
CN28150	18-20 Gauge	BL10800	Packard 630 Spec. Series, Unsealed

Part Number	Description	Mates With	Type
CN28210	12-14 Gauge	CN29980	Packard GT 280 Series, Sealed
CN28220	16-18 Gauge	CN29990	Packard GT 280 Series, Sealed

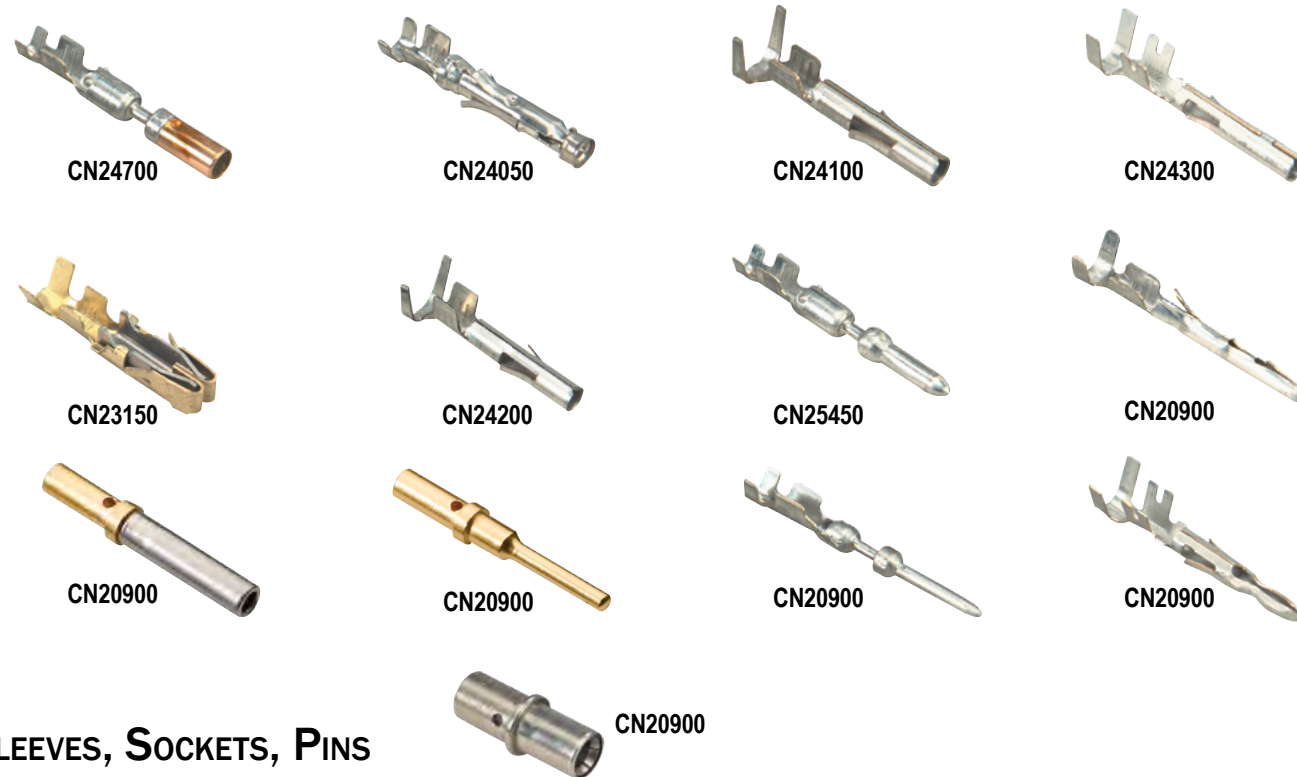
MALE

CN20250	14 Gauge		Packard 100 Series, Straight, Micro-Pack
CN20300	16-18 Gauge		
CN20350	20-22 Gauge		
CN29980	12-14 Gauge	CN28210	Packard 150 Series, Sealed
CN29990	16-18 Gauge	CN28220	
CN29960	18-20 Gauge	CN26400	
CN29970	20-22 Gauge	CN26410	
CN29550	10-12 Gauge	CN26450, CN26030	Packard 280 Series, Sealed
CN25650	12-14 Gauge	CN26500, CN26050	
CN29650	16-18 Gauge	CN26550 or CN26100	
CN29700	20-22 Gauge	CN26600, CN26110	
CN29750	10 Gauge	CN26650	Packard 280 Series, Unsealed
CN29800	12 Gauge	CN26700	
CN29850	14-16 Gauge	CN26750	
CN29900	18 Gauge	CN26800, CN28610	
CN29950	20-22 Gauge	CN26850	
CN29520	10 Gauge	CN27430	Packard 480 Series, Sealed
CN29500	10 Gauge	CN27420	
CN29250	10 Gauge	CN27450 or CN27500	Packard 480 Series, Unsealed
CN29300	12 Gauge	CN27500	
CN29350	14-16 Gauge	CN27550, CN27560, CN27570	
CN29400	18 Gauge	CN27600 or CN27650	
CN29450	20-22 Gauge	CN27650	
CN20950	10-12 Gauge	CN26900, CN26950	Packard 56 Series, Unsealed
CN21000	12 Gauge	CN26900, CN26950	
CN21050	14-16 Gauge	CN26960, CN27760, CN27000, CN27800, CN20800	
CN21100	18-20 Gauge	CN26970, CN27810, CN27820, CN27850, CN20800	
CN29050	10 Gauge	CN27150 or CN28000	Packard 630 Series, Unsealed
CN29100	12 Gauge	CN27200	
CN29150	14-16 Gauge	CN29250 or CN27950	
CN29200	18-20 Gauge	CN27300, CN27310, CN27900	

MISCELLANEOUS

CN20450	16-20 Gauge		Amp Junior Power Timer
CN20600	16-20+ Gauge		Amp Junior Power Timer

Part Number	Description	Mates With	Type
CN20050	Bullet, .180 12-14 Gauge		
CN21210	Female 480 Series Special 12-14 Gauge		
CN21160	Female Lamp Socket		
CN21180	Female Pack-Con III		
CN21150	Molex, 16 AWG		
CN20800	Quick Connect, Amp 14-18 Gauge		
CN20750	Quick Connect, Large		
CN20700	Quick Connect, Small		
CN20150	Wedge, Amp		
CN20200	Wedge, Packard 18-20 Gauge (2 each)		
CN20900	Whitaker, Mates w/ 1/4 Blade Terminal		



SLEEVES, SOCKETS, PINS

Table 15-38: Connectors: Sleeves, Sockets, Pins

Part Number	Description	Mates With
AMP		
CN24150	Amp Mate-N-Lok, 10-12 Gauge	
CN24200	Amp Mate-N-Lok, 14 Gauge	
CN24250	Amp Mate-N-Lok, 16-20 Gauge	
CN25050	Amp Pin, 18-20 Gauge	
CN24100	Amp Sleeve/Socket, 14-20 Gauge	
CN24050	Amp Sleeve/Socket, 16-18 Gauge	

Part Number	Description	Mates With
CARDELL PIN		
CN25400	Cardell Pin	
CN25460	Cardell Pin, 10-12 Gauge	
CN25450	Cardell Pin, 14-16 Gauge	
CN25470	Cardell Pin, 18-20 Gauge	
CN24810	Cardell Sleeve, 10-12 Gauge	
CN24750	Cardell Sleeve, Large	
CN24700	Cardell Sleeve, Larger Gauge	
CN24800	Cardell Sleeve, Medium, 14-16 Gauge	

DEUTSCH SOCKET

CN24450	6 Gauge, Use with 30 Series	CN25100
CN24500	8-10 Gauge, Use with 30 Series	CN25150
CN24550	12-14 Gauge, Use with 30 Series	CN25200
CN24600	14-16 Gauge, Use with 10 or 30 Series	CN25250
CN24650	16-18 Gauge, Use with 10 or 30 Series	CN25300
CN24660	20-24 Gauge	CN25310
CN25200	12-14 Gauge, Use with 30 Series	CN24550
CN25350	12-14 Gauge, Use with HD 10 Series	
CN25250	14-16 Gauge, Use with 10 or 30 Series	CN24600
CN25300	16-18 Gauge, Use with 10 or 30 Series	CN24650
CN25100	6 Gauge, Use with 30 Series	CN24450
CN25150	8-10 Gauge, Use with 30 Series	CN24500

DEUTSCH SOCKET, GOLD PINNING

CN25210	12-14 Gauge	CN24560
CN25260	14-16 Gauge	CN24610
CN25320	16-18 Gauge	CN24670
CN25330	20-24 Gauge	CN24680

DEUTSCH SOCKET, GOLD PLATING

CN24560	12-14 Gauge	CN25210
CN24610	14-16 Gauge	CN25260
CN24670	16-18 Gauge	CN25320
CN24680	20-24 Gauge	CN25330

PACKARD

CN25500	Packard Weatherpack I-Pin, 12 Gauge	
CN25550	Packard Weatherpack I-Pin, 14-16 Gauge	
CN25600	Packard Weatherpack I-Pin, 18-20 Gauge	
CN24300	Packard Sleeve, Weatherpack 12 Gauge	
CN24350	Packard Sleeve, Weatherpack 14-16 Gauge	
CN24400	Packard Sleeve, Weatherpack 18-20 Gauge	

TERMINAL ENDS FOR FUSES & RELAYS

Table 15-39: Connectors: Terminal Ends for Fuses and Relays

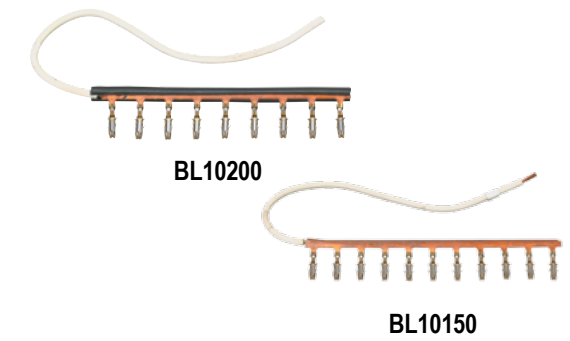
Part Number	Description	Type
CN43100	40 Way Terminal End, Female	40 Way
CN43050	40 Way Terminal End, Male	41 Way
CN14900	40 Way Terminal End, Male	42 Way
CN23350	16 Gauge	Cardell
CN23300	10-12 Gauge	Cardell
CN23400	18-20 Gauge (Small)	Cardell
CN23450	8-10 Gauge (Large)	Cardell
CN23150	10-12 Gauge	Dill
CN23200	14-16 Gauge	Dill
CN23250	18-20 Gauge	Dill
CN30400	Terminals	Flachstecker
CN30500	Terminals	Flachstecker
CN30550	Terminals	Flachstecker
CN23100	14-16 Gauge	Maxi Fuses
CN30650	14-16 Gauge	MCP 2.8
CN22050	14-16 Gauge	Micro Relays (Large)
CN22150	18-20 Gauge	Micro Relays (Large)
CN22200	22-24 Gauge (2 each)	Micro Relays (Large)
CN22300	18-20 Gauge	Micro Relays (Small)
CN22350	22-24 Gauge, Fuse Module	Micro Relays (Small)
CN22900	10-12 Gauge	Mini Fuses
CN22950	14 Gauge (2 each)	Mini Fuses
CN22800	14-16 Gauge	Mini Fuses
CN23000	18 Gauge (2 each)	Mini Fuses
CN22850	18-20 Gauge	Mini Fuses
CN23850	14-16 Gauge	Terminal
CN30250	Junior Power	Timer
CN30150	Junior Power	Timer
CN23550	10-12 Gauge	United Technologies
CN23500	12-14 Gauge	United Technologies
CN22650	10-12 Gauge	United Technologies
CN22600	14-16 Gauge	United Technologies
CN22700	14-16 Gauge (2 each)	United Technologies
CN22550	18-20 Gauge	United Technologies
CN60450	Terminal	United Technologies
CN30100	Terminal	United Technologies



TERMINAL BLOCKS AND BUS BARS

Table 15-40: Connectors: Terminal Ends for Fuses and Relays

Part Number	Description	Type
CN15450	5 Terminal Bus Bar	Bus Bar
BL10150	Bus Bar, 11 Terminals	Bus Bar
BL10200	Bus Bar, 9 Terminals	Bus Bar



SEALS, RETAINERS, & COMBS

Table 15-41: Connectors: Seals, Retainers, & Combs

Part Number	Description
-------------	-------------

CABLE SEALS

CN50600	Seal, Deutsch Size 2
CN50650	Seal, Deutsch Size 3
CN50700	Seal, Deutsch Size 8
CN50150	Seal, Packard
CN50100	Seal, Packard
CN50200	Seal, Packard
CN50500	Seal, Packard 10 AWG 480 Series
CN50450	Seal, Packard 10-12 AWG 480 Series
CN50250	Seal, Packard 16 AWG
CN50800	Seal, Packard 22-24 AWG
CN50900	Seal, Packard 22-24 AWG Cable

CAVITY PLUGS

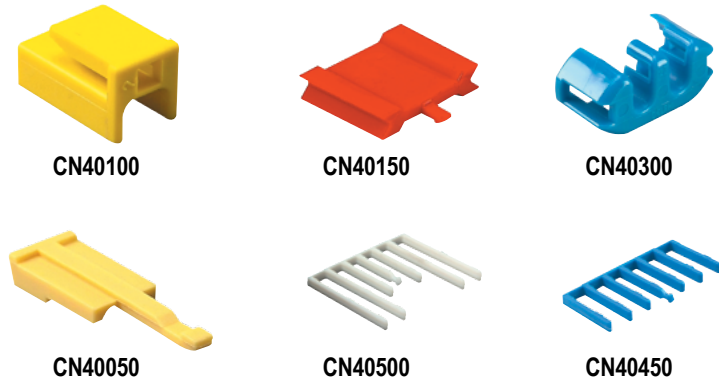
CN50550	Cavity Plug, Deutsch
CN50300	Cavity Plug, Packard
CN50950	Cavity Plug, Packard Red

LOCKS

CN40050	Lock, Dill
CN40150	Lock, Fargo
CN40100	Lock, Fargo
CN41050	Lock, Packard 2 Term Metri-Pack 150 Series
CN40300	Lock, Packard 2 Term Metri-Pack 280 Series
CN40250	Lock, Packard 2 Term Metri-Pack 480 Series
CN40350	Lock, Packard 3 Term
CN41100	Lock, Packard 3 Term Metri-Pack 150 Series

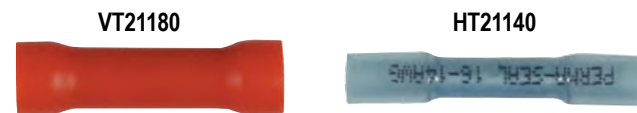


Part Number	Description
CN41150	Lock, Packard 4 Term Metri-Pack 150 Series
CN41200	Lock, Packard 6 Term Metri-Pack 150 Series
CN40400	Lock, Packard 6 Term Metri-Pack 280 Series
CN40450	Lock, Packard Comb Type
CN40500	Lock, Packard Comb Type
CN40200	Lock, Packard Metri-Pack 630 Series



WEDGELOCK

CN40550	WedgeLock, Deutsch 2 Cavity Pin
CN40600	WedgeLock, Deutsch 2 Cavity Socket
CN40650	WedgeLock, Deutsch 3 Cavity Pin
CN40700	WedgeLock, Deutsch 3 Cavity Socket
CN40750	WedgeLock, Deutsch 8 Cavity Pin
CN40800	WedgeLock, Deutsch 8 Cavity Socket



NYLON INSULATED TERMINALS

Table 15-42: Connectors: Nylon Insulated Terminals

Part Number	Description	Package	Color	Stud-Wire Size
-------------	-------------	---------	-------	----------------

BUTT SPLICES

VT2108C0	8 Butt Splices, Gray, Clam Shell (10 per pkg.)	Clam Shell (10 per pkg.)	Gray	8
VT21100	12-10 Butt Splices, Yellow, Bulk (100 per box)	Bulk (100 per box)	Yellow	12-10
VT2110C0	12-10 Butt Splices, Yellow, Clam Shell (10 per pkg.)	Clam Shell (10 per pkg.)	Yellow	12-10
VT21140	16-14 Butt Splices, Blue, Bulk (100 per box)	Bulk (100 per box)	Blue	16-14
VT2114C0	16-14 Butt Splices, Blue, Clam Shell (10 per pkg.)	Clam Shell (10 per pkg.)	Blue	16-14
VT21180	22-18 Butt Splices, Red, Bulk (100 per box)	Bulk (100 per box)	Red	22-18
VT2118C0	22-18 Butt Splices, Red, Clam Shell (10 per pkg.)	Clam Shell (10 per pkg.)	Red	22-18

HEAT SHRINKABLE, BUTT SPLICE

HT2108C0	Heat Shrinkable, Butt Splice, 8 AWG, Clear Pink, Clam Shell (5 per pkg)	Clam Shell (5 per pkg)	Clear Pink	8 AWG
HT21100	Heat Shrinkable, Butt Splice, 12-10 AWG, Yellow, Bulk (25 per box)	Bulk (25 per box)	Yellow	12-10 AWG
HT2110C0	Heat Shrinkable, Butt Splice, 12-10 AWG, Yellow, Clam Shell (5 per pkg)	Clam Shell (5 per pkg)	Yellow	12-10 AWG
HT21140	Heat Shrinkable, Butt Splice, 16-14 AWG, Blue, Bulk (25 per box)	Bulk (25 per box)	Blue	16-14 AWG
HT2114C0	Heat Shrinkable, Butt Splice, 16-14 AWG, Blue, Clam Shell (5 per pkg)	Clam Shell (5 per pkg)	Blue	16-14 AWG
HT21180	Heat Shrinkable, Butt Splice, 22-18 AWG, Red, Bulk (25 per box)	Bulk (25 per box)	Red	22-18 AWG
HT2118C0	Heat Shrinkable, Butt Splice, 22-18 AWG, Red, Clam Shell (5 per pkg)	Clam Shell (5 per pkg)	Red	22-18 AWG

MISCELLANEOUS CONNECTORS & PLUGS

Table 15-43: Connectors: Miscellaneous Connectors & Plugs

Part Number	Description	Type
CN61300	Plug	
CN15150	Cover	
CN15200	Fuse Block	
CN61250	2-Way, Dummy	
CN42900	4-Way, Shroud	
CN42700	22-Way, Weatherpack	
CN40850	Packard MP 150 Series 2-Terminal	Terminal Locks
CN40900	Packard MP 150 Series 3-Terminal	Terminal Locks
CN40950	Packard MP 150 Series 4-Terminal	Terminal Locks
CN41000	Packard MP 150 Series 6-Terminal	Terminal Locks

SPLICE CONNECTORS



Table 15-44: Connectors: Splice

Part Number	Description	Package	Color	Stud-Wire Size
VT8100C0	12-10 AWG Splice Connector, Yellow, Clam Shell (5 per pkg)	Clam Shell (5 per pkg)	Yellow	12-10 AWG
VT81010	16-14 AWG Splice Connector, Blue, Bulk (50 per box)	Bulk (50 per box)	Blue	16-14 AWG
VT8101C0	16-14 AWG Splice Connector, Blue, Clam Shell (5 per pkg)	Clam Shell (5 per pkg)	Blue	16-14 AWG

CABLE TIES

STANDARD & STAINLESS STEEL

- Stainless Steel Ties
- Self-locking, ball bearing mechanism enables quick and easy installation.
- Fully enclosed head does not allow dirt to interfere with locking mechanism.
- High tensile strength option adds strength and safety on heavy-duty applications.
- Available in medium corrosion-resistance 304 stainless and high corrosion-resistance 316 stainless steel.



Table 15-45: Stainless Steel Cable Ties

Part Number	Description	Length (in/cm)	Tensile (lb.)	Package Qty.
-------------	-------------	----------------	---------------	--------------

STAINLESS STEEL

CTS1513	5" (12.7cm), 150lb., 316 Stainless Steel	5 (12.7)	150	10
CTS1512	5" (12.7cm), 150lb., 304 Stainless Steel	5 (12.7)	150	10
CTS2514	7-1/2" (19.1cm), 150lb., 316 Stainless Steel	7-1/2 (19.1)	150	10
CTS2513	7-1/2" (19.1cm), 150lb., 304 Stainless Steel	7-1/2 (19.1)	150	10
CTS2716	8" (20.1cm), 250lb., 316 Stainless Steel	8 (20.1)	250	10
CTS2715	8" (20.1cm), 250lb., 304 Stainless Steel	8 (20.1)	250	10
CTS5513	14-5/16" (36.3cm), 150lb., 304 Stainless Steel	14-5/16 (36.3)	150	10
CTS5514	14-5/16" (36.3cm), 150lb., 316 Stainless Steel	14-5/16 (36.3)	150	10
CTS5715	14-5/16" (36.3cm), 250lb., 304 Stainless Steel	14-5/16 (36.3)	250	10
CTS5716	14-5/16" (36.3cm), 250lb., 316 Stainless Steel	14-5/16 (36.3)	250	10
CTS6515	20-1/2" (52.1cm), 150lb., 316 Stainless Steel	20-1/2 (52.1)	150	10
CTS6514	20-1/2" (52.1cm), 150lb., 304 Stainless Steel	20-1/2 (52.1)	150	10
CTS6717	20-1/2" (52.1cm), 250lb., 316 Stainless Steel	20-1/2 (52.1)	250	10
CTS6716	20-1/2" (52.1cm), 250lb., 304 Stainless Steel	20-1/2 (52.1)	250	10
CTS7513	26-13/16" (68.1cm), 150lb., 316 Stainless Steel	26-13/16 (68.1)	150	10
CTS7511	26-13/16" (68.1cm), 150lb., 304 Stainless Steel	26-13/16 (68.1)	150	10
CTS7714	26-13/16" (68.1cm), 250lb., 304 Stainless Steel	26-13/16 (68.1)	250	10
CTS7712	26-13/16" (68.1cm), 250lb., 316 Stainless Steel	26-13/16 (68.1)	250	10
CTS8513	33" (83.8cm), 150lb., 304 Stainless Steel	33 (83.8)	150	10
CTS8514	33" (83.8cm), 150lb., 316 Stainless Steel	33 (83.8)	150	10
CTS8715	33" (83.8cm), 250lb., 304 Stainless Steel	33 (83.8)	250	10
CTS8416	33" (83.8cm), 250lb., 316 Stainless Steel	33 (83.8)	250	10

- Engineered and manufactured for maximum performance and quality.
- Varying strengths and lengths for each individual application.



Table 15-46: Standard Cable Ties

Part Number	Description	Length (in/cm)	Tensile (lb.)	Color	Package Qty.
-------------	-------------	----------------	---------------	-------	--------------

STANDARD

CT01111	4" (10.2cm), 18lb., Black	4 (10.2)	18	Black	100
CT01112	4" (10.2cm), 18lb., Natural	4 (10.2)	18	Natural	100
CT01115	5-3/4" (14.6cm), 18lb., Natural	5-3/4 (14.6)	18	Natural	100
CT01114	5-3/4" (14.6cm), 18lb., Black	5-3/4 (14.6)	18	Black	100
CT01116	5-3/4" (14.6cm), 30lb., Black	5-3/4 (14.6)	30	Black	100
CT01117	5-3/4" (14.6cm), 30lb., Natural	5-3/4 (14.6)	30	Natural	100
CT03112	8" (20.3cm), 18lb., Natural	8 (20.3)	18	Natural	100
CT03111	8" (20.3cm), 18lb., Black	8 (20.3)	18	Black	100
CT03317	8" (20.3cm), 50lb., Natural	8 (20.3)	50	Natural	100
CT03316	8" (20.3cm), 50lb., Black	8 (20.3)	50	Black	100
CT03517	8-1/2" (21.6cm), 120lb., Black	8-1/2 (21.6)	120	Black	50
CT03718	8-3/4" (22.2cm), 250lb., Black	8-3/4 (22.2)	250	Black	25
CT04311	11-3/4" (29.8cm), 50lb., Black	11-3/4 (29.8)	50	Black	100
CT04312	11-3/4" (29.8cm), 50lb., Natural	11-3/4 (29.8)	50	Natural	100
CT04313	11-3/4" (29.8cm), 50lb., Red	11-3/4 (29.8)	50	Red	100
CT05512	15-1/4" (38.7cm), 120lb., Black	15-1/4 (38.7)	120	Black	50
CT05513	15-1/4" (38.7cm), 120lb., Natural	15-1/4 (38.7)	120	Natural	50
CT05317	15-1/2" (39.4cm), 50lb., Black	15-1/2 (39.4)	50	Black	100
CT05318	15-1/2" (39.4cm), 50lb., Natural	15-1/2 (39.4)	50	Natural	100
CT06712	20" (50.8cm), 250lb., Black	20 (50.8)	250	Black	25
CT06518	21" (53.3cm), 150lb., Black	21 (53.3)	150	Black	25
CT06519	21" (53.3cm), 150lb., Natural	21 (53.3)	150	Natural	25
CT08512	32" (81.3cm), 150lb., Black	32 (81.3)	150	Black	50
CT09711	35" (88.9cm), 250lb., Natural	35 (88.9)	250	Natural	25
CT09512	37" (94cm), 150lb., Black	37 (94)	150	Black	25

SPECIALTY TIES

Button Head

- Two-piece tie providing for parallel entry and exit through the head.
- Manufactured from black, high-impact nylon 6/6.
- The strap contains serrations on both sides and the head has two opposed pawls covered by a spherical dome top.
- The design enables the strap to be directed clockwise or counter clockwise prior to insertion into the head, enabling bidirectional looping.

Dual Clamp

- Designed to provide parallel spacing between hoses, wires, cables, and tubing, protecting them from abrasion.
- An optional mounting hole for securing bundles along the chassis of trucks and trailers.
- The unique one-piece design features the dual head centered on the strap.

Mountable

- Wide variety of mounting bases suited for many applications.
- Used in conjunction with cable ties to stabilize and secure wiring bundles, both indoors and outdoors.
- Can be secured to a surface using rubber-based adhesive, acrylic adhesive, or can be screw mounted.

Releasable

- Releasable cable ties provide easy removal as well as reusability.



Table 15-47: Specialty Cable Ties

Part Number	Description	Length (in/cm)	Tensile (lb.)	Color	Package Qty.
BUTTON HEAD					
CTB3520	9-1/2" (24.1cm), 100lb., Black	9-1/2 (24.1)	100	Black	10
CTB5518	15" (38.1cm), 100lb., Black	15 (38.1)	100	Black	10
CTB5519	15" (38.1cm), 120lb., Black	15 (38.1)	120	Black	10

Part Number	Description	Length (in/cm)	Tensile (lb.)	Color	Package Qty.
-------------	-------------	----------------	---------------	-------	--------------

DUAL CLAMP

CTD6511	9-1/4" (23.4cm), 150lb., Black	9-1/4 (23.4)	150	Black	50
---------	--------------------------------	--------------	-----	-------	----

MOUNTABLE

CTM2112	6-1/4" (15.9cm), 30lb., #8 Screw, Natural	6-1/4 (15.9)	30	Natural	100
CTM2111	6-1/4" (15.9cm), 30lb., #8 Screw, Black	6-1/4 (15.9)	30	Black	100
CT3312M0	8" Fir Tree (.343-.363" Hole), Black	8 (20.3)	50	Black	10
CTM3314	8" (20.3cm), 50lb., Heat Stable, Tree (.246-.276" Hole), Black	8 (20.3)	50	Black	10
CTM3313	8" (20.3cm), 50lb., Arrow Head, Black	8 (20.3)	50	Black	100
CTM2213	8-1/2" (21.6cm), 50lb., #10 Screw, Natural	8-1/2 (21.6)	50	Natural	100
CTM2212	8-1/2" (21.6cm), 50lb., #10 Screw, Black	8-1/2 (21.6)	50	Black	100
CTM6311	16" (40.6cm), 50lb., #10 Screw, Black	16 (40.6)	50	Black	100
CTM6312	16" (40.6cm), 50lb., #10 Screw, Natural	16 (40.6)	50	Natural	100
CTM5520	16-1/4" (41.3cm), 120lb., 1/4-20 Stud, Black	16-1/4 (41.3)	120	Black	10
CTM5513	16-1/4" (41.3cm), 120lb., 1/4" Screw, Natural	16-1/4 (41.3)	120	Natural	50
CTM5512	16-1/4" (41.3cm), 120lb., 1/4" Screw, Black	16-1/4 (41.3)	120	Black	50

RELEASABLE

CTR3719	9" (22.9cm), 250lb., Releasable, Black	9 (22.9)	250	Black	25
---------	--	----------	-----	-------	----



TOOLS

DEUTSCH CONNECTOR TOOLS

- For use with Deutsch pins and sockets



RT10050



RT10150



RT10200



RT10100



CT10050

Table 15-48: Deutsch Connector Tools

Part Number	Description
RT10100	Deutsch Connector Removal Tool, 8-10 Gauge
RT10050	Deutsch Connector Removal Tool, 6 Gauge
RT10200	Deutsch Connector Removal Tool, 14-16 Gauge
RT10150	Deutsch Connector Removal Tool, 12 Gauge
CT10050	Crimp Tool, 12-20 Gauge, Solid Contact

Note: A TRP® Electrical Repair Kit (PN CN15350) is also available.

MISCELLANEOUS TOOLS


For Connectors See pg. 15-26. 

Table 15-49: Electrical Tools, Miscellaneous

Part Number	Description	Type
CT10250	480 M/P	Crimper
CT10200	56 Series, Splices	Crimper
CT10350	Packard	Crimper
CN60400	Packard	Extraction

CABLE TIE TOOLS

- Specifically developed for maximum ergonomic and performance values.
- Combine reduced hand effort and durable components to ensure efficient assembly and a longer life cycle
- Low-friction bearing mechanisms reduce hand effort and provide a smooth stroke



CM11200



CM11300



CM11350



CM11250

Table 15-50: Cable Tie Tools

Part Number	Description
CM11250	Cable Tie Twist Tool, 18-50 lbs. Ties
CM11300	Cable Tie Twist Tool, 120-150 lbs. Ties
CM11400	Cable Tie Tool, Stainless Ties
CM11200	Cable Tie Tool, Mark 9, 50-255 lbs. Ties
CM11350	Cable Tie Tool, 18-50 lbs. Ties



*For information, updates, or corrections,
please contact us at TRPBus@TRPParts.com*

*No part of this marketing material may be
reproduced in any manner without written
permission from TRP® North America.*

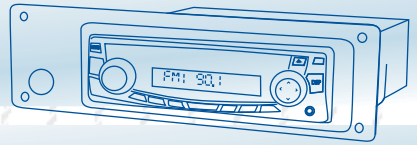
TRP® North America

750 Houser Way N.
Renton, WA 98057

www.trpparts.com



Parts for all brands of buses.



16

BUS PARTS

AUDIO/VIDEO

*Proven, reliable and
always innovative.*

TRP® offers reliable aftermarket products that are designed and tested to exceed customers' expectations regardless of the bus make, model or age.



**ANTENNAS • CAMERA EQUIPMENT • RADIO/CD
PLAYERS • SPEAKERS • HORNS**



Tested. Reliable. Guaranteed.

Audio/Video

Choosing the right replacement part or service for your vehicle—whether you own one, or a fleet—is one of the most important decisions you can make for your business. And, with tested TRP® parts it's an easy decision.

Regardless of the make you drive, TRP® quality replacement parts are engineered to fit your truck, trailer or bus. Choose the parts that give you the best value for your business. Check them out at an approved TRP® retailer near you.

The cross reference information in this catalog is based upon data provided by several industry sources and our partners. While every attempt is made to ensure the information presented is accurate, we bear no liability due to incorrect or incomplete information.

Product Availability

Due to export restrictions and market demands, not all products are always available in every location. Check for availability in your area with your local TRP® Distributor.

No part of this marketing material may be reproduced in any manner without written permission from TRP® North America.

CONTENTS

RADIO/CD PLAYERS

AM/FM Radios with CD Players	16-3
AM/FM Radios	16-4
Microphones	16-4
Panels	16-5

ANTENNAS & SPEAKERS

Antennas	16-6
Speakers & Grills	16-6

HORNS

Horns	16-7
-----------------------------	------

CAMERAS

Camera Equipment	16-8
--	------

TRP® North America

750 Houser Way N.
Renton, WA 98057

www.trpparts.com

RADIO/CD PLAYERS

For Speakers See pg. 16-6.



PP102629



PP103143



PP104343



PP103144



PP102815



PP104341

AM/FM RADIOS WITH CD PLAYERS

Table 16-1: AM/ FM Radios with CD Players

Part Number	Description	Best Fits
PP102629	Panasonic AM/FM CD player w/ International Bus harness	IC Bus
PP102815	Panasonic AM/FM CD player w/ P.A. Microphone & International Bus harness	IC Bus
PP103143	Panasonic AM/FM CD player w/ adapter panel & International Bus harness	IC Bus
PP103144	Panasonic AM/FM CD player w/P.A. Microphone, adapter panel & International Bus harness	IC Bus
PP103222	Panasonic AM/FM MP3/CD Player with PA/Receiver with Microphone and Plug and Play Harness	n/a
PP103223	Panasonic AM/FM CD player w/ Thomas Bus harness	Thomas
PP104341	Panasonic AM/FM, with PA CRCM120, Thomas Bus	Thomas
PP104342	Panasonic AM/FM, CRCM120, International Bus, no PA	IC Bus
PP104343	Panasonic AM/FM, CRCM120, Thomas Bus, no PA	Thomas
PP103341	Delphi AM/FM CD player w/P.A. Microphone & Thomas Bus harness	Thomas
PP104191	Delphi AM/FM CD player w/P.A. Microphone & International Bus harness	IC Bus



AM/FM RADIOS

Table 16-2: AM/ FM Radios

Part Number	Description	Best Fits
PP103347	Delphi AM/FM receiver w/P.A. Microphone & Thomas Bus harness	Thomas
PP104190	Delphi AM/FM receiver w/P.A. Microphone & International Bus harness	IC Bus



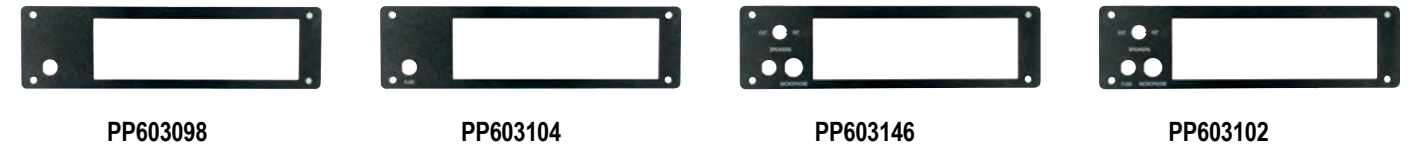
PAN5PM

MICROPHONES

Table 16-3: Microphones

Part Number	Description	Best Fits
PAN5PM	P.A. Replacement microphone, rotary volume control	IC Bus

For Radios See pg. 16-3.

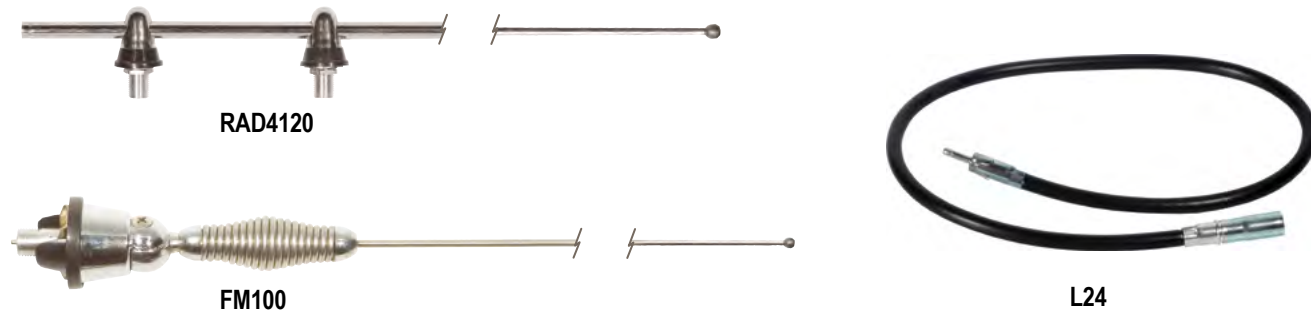


PANELS

Table 16-4: Radio Faceplate Panels

Part Number	Description	Best Fits
PP603098	Replacement Faceplate panel for PP103143	IC Bus
PP603102	Replacement Faceplate panel for PP103093 & PP103095	IC Bus
PP603104	Replacement Faceplate panel for PP103096 & PP103127	IC Bus
PP603146	Replacement Faceplate panel for PP103144	IC Bus

ANTENNAS & SPEAKERS



ANTENNAS

Table 16-5: Antennas

Part Number	Description
FM100	AM/FM antenna, adjustable mount, universal fit
RAD4120	AM/FM antenna, dual-base, side-mount, universal fit
L24	AM/FM antenna extension cable, 2-foot



PPC00185



PP303142

SPEAKERS & GRILLS

Table 16-6: Speakers & Grills

Part Number	Description
PPC00185	Speaker grill replacement, 4"
PP303142	Speaker - 4" dual-cone

HORNS



PP302971 / PP301424



H00910CA



H00755NS

HORNS

Table 16-7: Horns

Part Number	Description	Best Fits
PP302971	Speaker horn - external, 8" round, yellow w/ Thomas Bus connector	Thomas
PP301424	Speaker horn - external, 8" round, yellow w/ International Bus connector	International/IC Bus
H00910CA	High Air Horn - Dual chrome projectors	n/a
H00755NS	Air Horn - Direct mount manual valve for lanyard pull	n/a



*For information, updates, or corrections,
please contact us at TRPBus@TRPParts.com*

*No part of this marketing material may be
reproduced in any manner without written
permission from TRP® North America.*

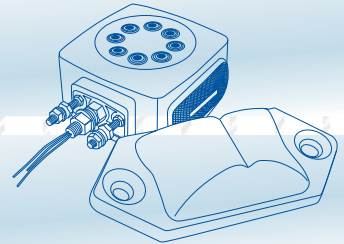
TRP® North America

750 Houser Way N.
Renton, WA 98057

www.trpparts.com



Parts for all brands of buses.



17

BUS PARTS

LIGHTING

*Proven, reliable and
always innovative.*

TRP® offers reliable aftermarket products that are designed and tested to exceed customers' expectations regardless of the bus make, model or age.



HALOGEN • HEADLAMPS • INCANDESCENT • LEDs
MOUNTING ACCESSORIES • STROBES



BUS PARTS

Tested. Reliable. Guaranteed.

Lighting

Choosing the right replacement part or service for your vehicle—whether you own one, or a fleet—is one of the most important decisions you can make for your business. And, with tested TRP® parts it's an easy decision.

Regardless of the make you drive, TRP® quality replacement parts are engineered to fit your truck, trailer or bus. Choose the parts that give you the best value for your business. Check them out at an approved TRP® retailer near you.

The cross reference information in this catalog is based upon data provided by several industry sources and our partners. While every attempt is made to ensure the information presented is accurate, we bear no liability due to incorrect or incomplete information.

Product Availability

Due to export restrictions and market demands, not all products are always available in every location. Check for availability in your area with your local TRP® Distributor.

No part of this marketing material may be reproduced in any manner without written permission from TRP® North America.

CONTENTS

STROBE LAMPS

<u>Bus Strobe Lights</u>	17-5
Low Profile Strobe	17-5
Medium Profile Strobe	17-5

LED LAMPS

<u>Backup/Reverse Lamps</u>	17-6
License Plate Light	17-6
Small Clear Round Backup Lamp	17-6
Small Round Reverse Light	17-6
Small Oval Clear Backup Lamp	17-6
<u>Bus Marker Lamps</u>	17-7
Small Triangle	17-7
Small Square	17-7
Large Round	17-7
<u>Clearance & Marker Lamps</u>	17-8
Small Round	17-8
Medium Round	17-8
Small Beehive	17-9
Medium Beehive	17-9
Small Rectangle, 3 LED	17-9
Small Rectangle, 12 LED	17-9
Double Bull's-Eye	17-9
Medium Rectangle	17-9
Small Rectangle, Thin Line	17-9
Medium-Large Rectangle	17-9
Small Oval	17-9
Large Rectangle	17-9
Large Wedge	17-10
<u>Interior & Courtesy Lamps</u>	17-10
Large Clear Lens	17-10

TRP® North America

750 Houser Way N.
Renton, WA 98057

www.trpparts.com

<u>Mounting Accessories</u>	17-10
Bases	17-10
Bezels	17-11
<u>Stop, Turn & Tail Lamps</u>	17-11
Small Rectangular	17-11
Small Round	17-11
Small Oval	17-12
Round Turn Signal	17-12
Stop, Turn & Tail Lamp with License Plate Light	17-12

INCANDESCENT LAMPS

<u>Clearance & Marker Lamps</u>	17-13
Rectangle Incandescent	17-13
Wedge Incandescent	17-13
<u>Interior & Courtesy Lamps</u>	17-14
Round Interior Dome Light	17-14
<u>Step Lamps</u>	17-15
Step Light	17-15
<u>Stop, Turn & Tail Lamps</u>	17-15
Round Park & Turn Signal	17-15
<u>Backup/Reverse Lamps</u>	17-17
Round Reverse Light	17-17
<u>Reflectors</u>	17-17
Reflectors	17-17
<u>Lenses</u>	17-19
7" Round Lenses	17-19
7.06" Round Lenses	17-20
Round Lens (Old Style)	17-20
Large Sconce Lenses	17-20
Large Block Rectangle Lenses	17-20
Large Wedge Lenses	17-20
Large Round Lenses with Reflectors	17-20
Large Square Lenses	17-20
Small Clear Bubble Lenses	17-20
Large Rectangle Clear Lenses	17-20

HALOGEN LAMPS

<u>Flood Lamps</u>	17-21
Halogen Utility Flood Light Kits	17-21
<u>Warning Lamps</u>	17-21
Warning Lights	17-21

HEADLAMP BULBS

<u>Halogen Bulbs</u>	17-22
----------------------------	-------

HEADLAMP ASSEMBLIES & MOUNTING

ACCESSORIES

<u>Headlamp Assemblies</u>	17-23
Headlight Body/Bucket	17-23
Small Headlight Assemblies	17-23
Large Round Headlight Assemblies	17-24
Large Rectangle Headlight Assemblies	17-24
<u>Mounting Accessories</u>	17-24
Bezels	17-24
Gaskets	17-24
Nests	17-24

BUS APPLICATIONS FOR LIGHTING

<u>Bus Applications for Lighting</u>	17-25
Blue Bird	17-25
International/IC Bus	17-25
Thomas Built	17-25

OEM

(QUALITY PRODUCTS FOR CRITICAL COMPONENTS)

THE LED ADVANTAGE

- Light emitting diodes produce light without the use of a filament, making them a brighter, more durable, energy-efficient alternative to incandescent lighting

MORE DURABLE

- 100,000 hour life equals a decade of normal use
- Virtually impervious to shock and vibration
- Completely sealed for protection from the elements
- Internal components are encapsulated in epoxy for resistance to moisture and corrosion
- All TRP® exterior lamps utilize UV-resistant polycarbonate lenses

MORE VISIBLE

- Brightness increases vehicle and trailer conspicuity
- Instantaneous illumination means more reaction time for trailing vehicles

DOT APPROVED

- Complies with FMVSS 108/CMVSS 108

ENERGY EFFICIENT

Up to 85% less power consumption means more power for other vehicle applications

WARRANTY

TRP® LED lamps are covered by a 10-year, unlimited miles replacement parts warranty to the original purchaser. The warranty does not apply to certain severe applications or chemical agents.

Other limitations and exceptions may apply. See your authorized dealer for details.



STROBE LAMPS

BUS STROBE LIGHTS

- Self-adjusting for day and night
- Quick replacement with 1-1/2 turn Xenon plug-in flash tubes
- Rugged, die-cast aluminum base for vibration resistance and heat dissipation
- Conformal coated circuit board
- Meets SAE J573 June 95 and SAE J1318 May 98
- 24-Month assembly warranty; 6-month flash tube warranty
- 1" pipe mounting thread in base

Combining the latest in electronic design and state-of-the-art engineering technologies, this innovative series of strobe lights showcase rugged die-cast aluminum bases, conformal coated circuit board, and strobes built to withstand the toughest environments. No tools needed to change the flash tube or remove the threaded O-ring sealed lens.

Models 4242 and 4262 have an expanded feature set based on the field-proven design of models 4241 and 4261. These lights include a setting to select between double and quad flash modes, and a day night sensor to ensure the proper amount of light as needed.



4241C



4262APR0

Table 17-1: Bus Strobe Lamps

Part Number	Description	Joules	Flash Pattern	Flashes per Minute	SAE Class	Amp Draw	Watts
LOW PROFILE STROBE							
4241C	Low Profile Strobe - Double Flash, 4.6" (117mm), Clear, Permanent Base, 12-24 VDC	12	Double	80	2	2.5	28.8
4242C	Low Profile Strobe - Double /Quad Flash, 4.6" (117mm), Clear, Permanent Base, 12-48 VDC	18/8**	Double/Quad	65	1*	3.7	42/33
4242A	Low Profile Strobe - Double /Quad Flash, 4.6" (117mm), Amber, Permanent Base, 12-48 VDC	18/8**	Double/Quad	65	2	3.7	42/33
4241APR0	Low Profile Strobe - Double Flash, 4.6" (117mm), Amber, Permanent Base, 12-24 VDC	12	Double	80	2	2.5	28.8

MEDIUM PROFILE STROBE

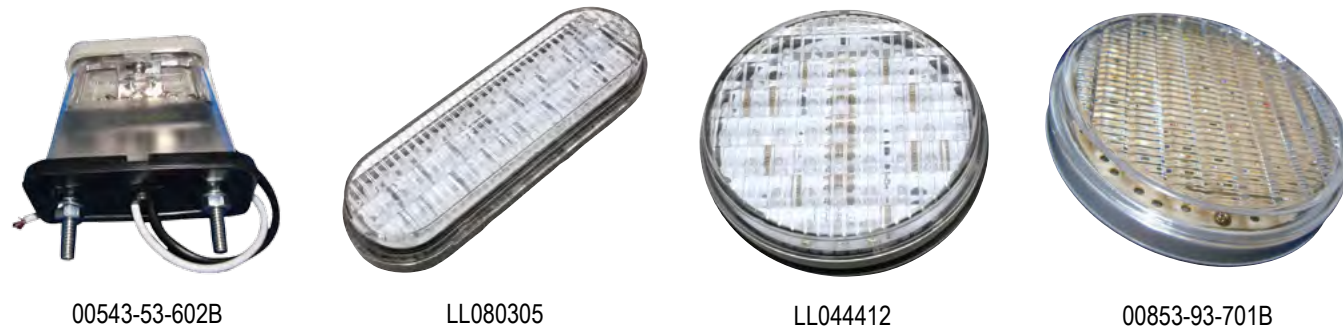
4261C	Medium Profile Strobe - Double Flash, 6.2" (156mm), Clear, Permanent Base, 12-24 VDC	12	Double	80	2	2.5	28.8
4262C	Medium Profile Strobe - Double /Quad Flash, 6.2" (156mm), Clear, Permanent Base, 12-48 VDC	18/8**	Double/Quad	65	1*	3.7	42/33
4261A	Medium Profile Strobe - Double Flash, 6.2" (156mm), Amber, Permanent Base, 12-24 VDC	12	Double	80	2	2.5	28.8
4262APR0	Medium Profile Strobe - Double /Quad Flash, 6.2" (156mm), Amber, Permanent Base, 12-48 VDC	18/8**	Double/Quad	65	1*	3.7	42/33

* Quad Mode Only

** Double Flash: Day = 13.5 Joules, Night = 8.1 Joules

** Quad Flash: Day = 18.2 Joules, Night = 11.9 Joules

LED LAMPS



00543-53-602B

LL080305

LL044412

00853-93-701B

BACKUP/REVERSE LAMPS

- Uses low current
- Standard 3-pin connector, or Hard Wired with 4" pigtail

Table 17-2: LED Backup Lamps

Part Number	Description	Base/Bezel
LICENSE PLATE LIGHT		
00543-53-602B	5 LED, 2-3/16" x 2-5/8" x 1-9/16" License Plate Light, Clear Polycarbonate lens, Gray housing with Bezel, Stud Mount; 1 Wire Terminal; 2-3/16" x 2-5/8" x 1-9/16"	
SMALL CLEAR ROUND BACKUP LAMP		
LL044412	4" Round, 45 LED, White, Clear Lens	GMX0102 or GMX0106
SMALL ROUND REVERSE LIGHT		
00853-93-701B	36 LED, 4" Round, Clear; 8-14 VDC Voltage	
SMALL OVAL CLEAR BACKUP LAMP		
LL080305	6" Oval 45 LED, Grommet Mount, Hard Wired	

BUS MARKER LAMPS

- SAE/DOT P2/PC combination light in horizontal and vertical orientation
- Hardwired with four inch pigtail
- Rooftop surface mount, no grommet required



LL041601

LL041702

LL060109

Table 17-3: LED Bus Marker Lamps

Part Number	Description
SMALL TRIANGLE	
LL041601	15 LED, 2-3/4" x 3-1/2", Amber, Triangle LED Light
LL041702	15 LED, 2-3/4" x 3-1/2", Red, Triangle LED Light
SMALL SQUARE	
PL7122A	4" Diode Surface Mount Marker Chrome Brush Guard
LARGE ROUND	
LL060109	31 LED, 7" Round, Amber, School Bus, Reflective Lens
LL060202	31 LED, 7" Round, Red, School Bus, Reflective Lens

CLEARANCE & MARKER LAMPS

- Uses standard 2-pin connection

For Bezels See pg. 17-10.

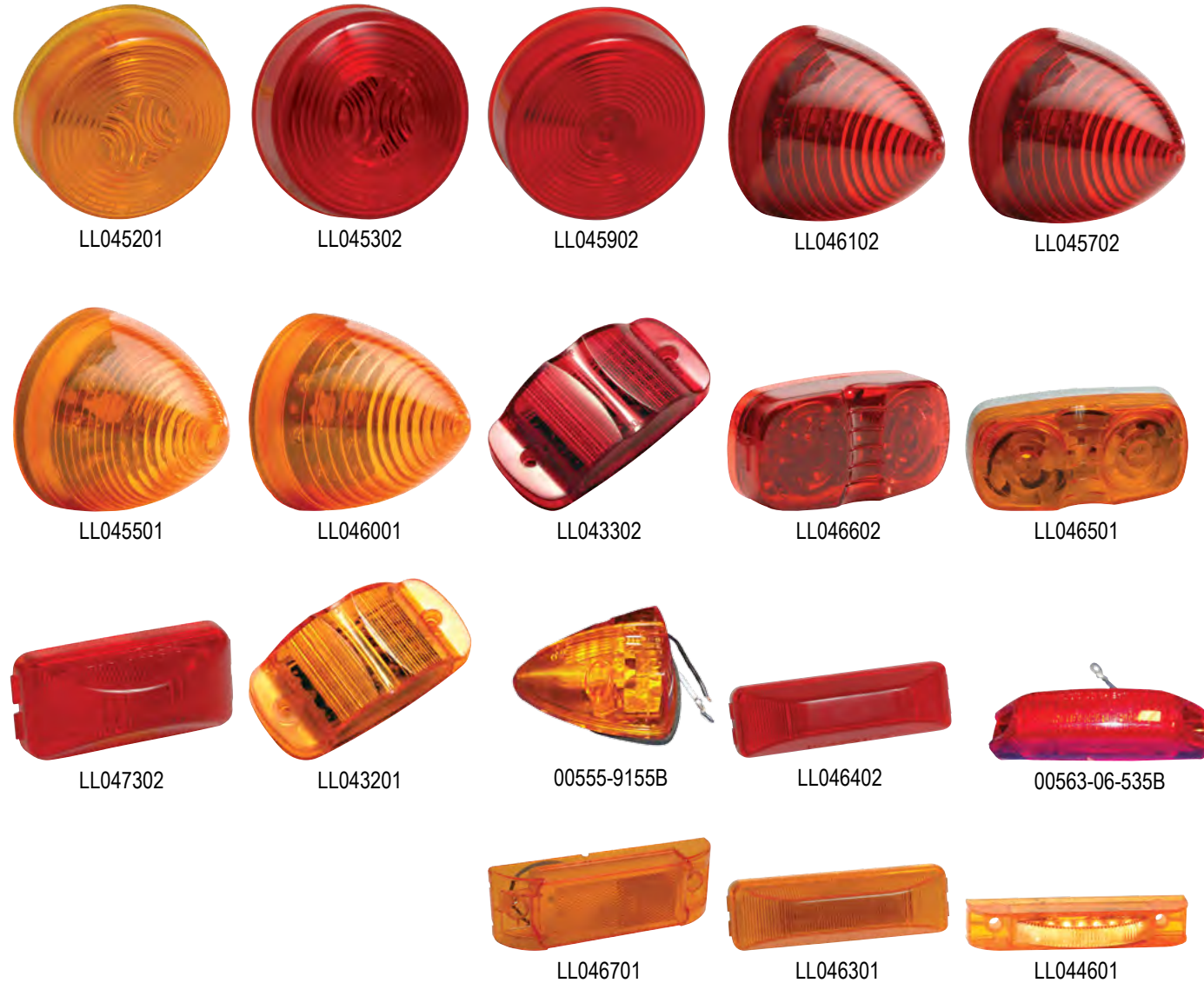


Table 17-4: LED Clearance & Marker Lamps

Part Number	Description	Base/Bezel
SMALL ROUND		
LL045201	9 LED, 2" Round, Amber	GMX1615 or GMX1616
LL045302	9 LED, 2" Round, Red	GMX1615 or GMX1616
MEDIUM ROUND		
LL040203	13 LED, 2-1/2" Round, Amber, Clear Lens	GMX0101 or GMX0105
LL045902	13 LED, 2-1/2" Round, Red	

Part Number	Description	Base/Bezel
SMALL BEEHIVE		
LL045501	9 LED, 2" Round Beehive, Amber	GMX1615 or GMX1616
LL045702	9 LED, 2" Round Beehive, Red	GMX1615 or GMX1616
MEDIUM BEEHIVE		
LL046102	13 LED, 2-1/2" Round Beehive, Red	
LL046001	13 LED, 2-1/2" Round Beehive, Amber	
SMALL RECTANGLE, 3 LED		
LL047302	3 LED, 1-1/4" x 2-1/2" Rectangle, Red	LL091110
SMALL RECTANGLE, 12 LED		
LL046301	12 LED, 1-1/4" x 4" Rectangle, Amber	LL091010
LL046402	12 LED, 1-1/4" x 4" Rectangle, Red	LL091010
DOUBLE BULL'S-EYE		
LL046501	13 LED 2" x 3-7/8" Double Bull's-Eye, Amber	MC8973
LL046602	13 LED 2" x 3-7/8" Double Bull's-Eye, Red	MC8973
MEDIUM RECTANGLE		
LL043201	14 LED, 2" x 4" Rectangle, Amber, Combination Side Marker, P2	
LL043302	14 LED, 2" x 4" Rectangle, Red, Combination Side Marker, P2	
SMALL RECTANGLE, THIN LINE		
LL044601	7 LED, Amber, 3/4" x 4" Rectangle, Thin Line	
LL043802	7 LED, Red, 3/4" x 4" Rectangle, Thin Line	
MEDIUM-LARGE RECTANGLE		
LL046701	10 LED Super 21, 2" x 5-7/8" Rectangle, Amber	
LL046802	10 LED Super 21, 2" x 5-7/8" Rectangle, Red	
SMALL OVAL		
LL047201	4 LED, 2-1/4" x 6-1/2" Oval, Amber	MD4307
LARGE RECTANGLE		
00563-01-535B	6 LED, 4" x 7/8" x 13/16" Rectangle, Amber; 8-14 VDC Voltage	
00563-06-535B	6 LED, 4" x 7/8" x 13/16" Rectangle, Red; 8-14 VDC Voltage	

Part Number	Description	Base/Bezel
-------------	-------------	------------

LARGE WEDGE

00555-9155B	15 LED, Wedge, Amber, Exterior Mount; 8-14 VDC Voltage; 3-1/2" x 2-3/4" x 1-11/16"	
00555-9655B	15 LED, Wedge, Red, Exterior Mount; 8-14 VDC Voltage; 3-1/2" x 2-3/4" x 1-11/16"	

INTERIOR & COURTESY LAMPS

- Hardwired, color-coded pigtail
- Conformal coated circuit board for exterior applications
- Surface mount, no grommet required



LL073105

Table 17-5: LED Interior & Courtesy Lamps

Part Number	Description	Base/Bezel
-------------	-------------	------------

LARGE CLEAR LENS

LL073105	Clear Lens, 14" x 3-5/8", 50 LED, ABS Housing, 3-way Switch	
----------	---	--



MOUNTING ACCESSORIES

Table 17-6: LED Mounting Accessories

Part Number	Description
-------------	-------------

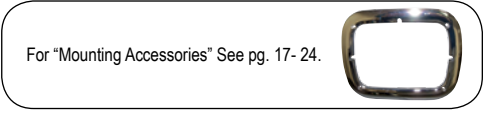
BASES

LL091010	1" x 4", Chrome
LL091110	2-1/2" x 1-1/4", Chrome

Part Number	Description
-------------	-------------

BEZELS

MC0102	4" Round
MC0104	6" Oval
MC0105	2 1/2" Round w/ Visor
MC0106	4" Round w/ Visor
MC0107	6" Oval w/ Visor
MC1615	2" Round
MC1616	2" Round w/ Visor
MD4307	6 5/8" x 2 1/4", Chrome
MC8973	Visor for Double Bull's-Eye



STOP, TURN & TAIL LAMPS

- Hardwired, with standard 3-pin connector
- Draws approximately 435 milliamps at 12.8 volts

Table 17-7: LED Stop, Turn & Tail Lamps

Part Number	Description	Base/Bezel
-------------	-------------	------------

SMALL RECTANGULAR

LL011801	52 LED, 3" x 5" Rectangular, Amber, Turn, Grommet Mount	
LL047702	52 LED, 3" x 5" Rectangular, Red, Grommet Mount	

SMALL ROUND

LL011402	10 LED, 4" Round, Surface Mount	
LL010902	12 LED, 4" Round, Red, Grommet Mount	

Part Number	Description	Base/Bezel
LL010301	44 LED, 4" Round, Amber, Turn, Grommet Mount	GMX0102 or GMX0106
LL010402	44 LED, 4" Round, Red, Grommet Mount	GMX0102 or GMX0106
LL010702	44 LED, 4" Round, Red, Flange Mount	GMX0102 or GMX0106
LL011302	52 LED, 4" Round, Red, Grommet Mount	

SMALL OVAL

LL012001	52 LED, 6" Oval, Amber, Turn, Grommet Mount	GMX0104 or GMX0107
LL012202	52 LED, 6" Oval, Red, Grommet Mount	GMX0104 or GMX0107
LL012401	52 LED, 6" Oval, Amber, Turn, Flange Mount	GMX0104 or GMX0107
LL012502	52 LED, 6" Oval, Red, Flange Mount	GMX0104 or GMX0107

ROUND TURN SIGNAL

00744-91-010B	31 Super LED with Reflector, 7" x 1-7/16" Round Turn Signal, Amber; 8-14 DC Voltage	
---------------	---	--

STOP, TURN & TAIL LAMP WITH LICENSE PLATE LIGHT

00200-2601B	31 Super LED, 7" x 1-7/16" Stop, Turn & Tail Lamp with License Plate Light, Red Lens, Clear License Plate Light, Stud Mount; 8-14 DC Voltage	
-------------	--	--

INCANDESCENT LAMPS



CLEARANCE & MARKER LAMPS

- Mounting pad and lens gasket included (where needed)

Table 17-8: Incandescent Clearance & Marker Lamps

Part Number	Description	Measurements (L/ W/ H or Diam/ H)	Housing	Lens
RECTANGLE INCANDESCENT				
00556-9101B	Amber, Interior Mount, Incandescent, 1 Wire Terminal; Blue Bird Aftermarket	3-3/4" x 1-7/16" x 1-13/16"		
00556-9601B	Red, Interior Mount, Incandescent, 1 Wire Terminal; Blue Bird Aftermarket	3-3/4" x 1-7/16" x 1-13/16"		
00500-01-637B	Amber, protective bulb hard-coating, Brush Guard, Flush mount; Snap-on lens. Bulb #1895. : 4-5/16" x 1-1/4" x 15/16" Bulb #904. : 3-3/4" x 1-1/2" x 1-3/4"	4-5/16" x 1-1/4" x 15/16"	Zinc di-chromate	
00541-1603B	Red, Brush Guard, 12 Volt, Aluminum die-cast housing with protective bulb hard-coating. 5-1/4" x 2-1/8" x 1-3/8" Bulb #67, 4 Candlepower Bulb #904. : 3-3/4" x 1-1/2" x 1-3/4"	5-1/4" x 2-1/8" x 1-3/8"	Aluminum	

WEDGE INCANDESCENT

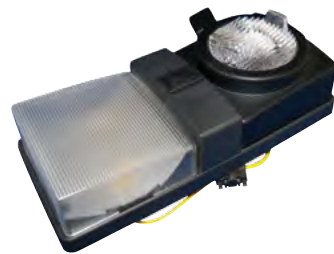
00555-9101B	Amber, Interior Mount, Incandescent; Acrylic. ABS housing. 12V bulb. Two holes in body for mount. 3-1/2" x 2-3/4" x 1-1/2"	3-1/2" x 2-3/4" x 1-1/2"	ABS plastic	Acrylic
00555-9169B	Amber, Exterior Mount, Incandescent; Acrylic lens; Steel housing. Two holes in body and lens; 12V bulb. Blue Bird Aftermarket. 3-1/2" x 2-3/4" x 1-1/2"	3-1/2" x 2-3/4" wide x 1-1/2"	Steel	Acrylic
00555-9601B	Red, Interior Mount, Incandescent; Acrylic; ABS housing; 12V bulb. 3-1/2" long x 2-3/4" x 1-1/2"	3-1/2" x 2-3/4" wide x 1-1/2"	ABS plastic	Acrylic
00555-9669B	Amber, Exterior Mount, Incandescent; Acrylic. Steel housing. Two holes in body and lens; Mount without removing lens. 12V bulb. 3-1/2" x 2-3/4" x 1-1/2"	3-1/2" x 2-3/4" x 1-1/2"	Steel	Acrylic

INTERIOR & COURTESY LAMPS

- Heavy Duty on/off rocker switch is weather-resistant.



00529-1344B



499-8060011



00596-00-047B

Table 17-9: Incandescent Interior & Courtesy Lamps

Part Number	Description	Measurements (L/ W/ H or Diam/ H)	Housing	Lens
-------------	-------------	-----------------------------------	---------	------

ROUND INTERIOR DOME LIGHT

00596-00-047B	Clear, 12 Candlepower: No Lens, Shallow body for small areas.	5-7/8" x 2-3/4" x 1-1/2"		
00529-1344B	Clear, 21 Candlepower bulb, Aluminum base, High output bulb #1141; 6-1/8" x 1-5/8"	6-1/8" x 1-5/8"	Aluminum	Polycarbonate
00596-00-048B	Clear, 21 Candlepower: No Lens, Shallow body for small areas.	5-7/8" x 2-3/4" x 1-1/2"		
00529-13-240B	Clear, Polycarbonate lens, Aluminum finish, High light output bulb #1141; 6-1/8" x 1-5/8"	6-1/8" x 1-5/8"		Polycarbonate
00529-1319B	Clear, Polycarbonate lens, Aluminum finish, with Ground and Connector, High light output bulb #1142. 6-1/8" x 1-5/8"	6-1/8" x 1-5/8"		Polycarbonate
499-8060011	Clear, Polycarbonate lens, Hole Mount, black ABS housing	7" x 3-1/8" x 2-3/8"	ABS plastic	Polycarbonate

STEP LAMPS

- Chrome-plated brass is rust and corrosion resistant.



00856-3360B

Table 17-10: Incandescent Step Lamps

Part Number	Description	Measurements (L/ W/ H or Diam/ H)	Housing	Lens
-------------	-------------	-----------------------------------	---------	------

STEP LIGHT

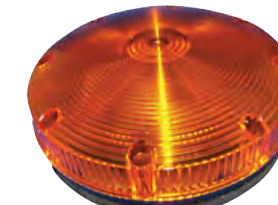
00856-3360B	Clear, Polycarbonate lens, Chrome-plated brass, with Hood over light; 3-11/16" x 2-7/8" x 2-1/8"	3-11/16" x 2-7/8" x 2-1/8"	Chrome-plated brass	
00856-33-240B	Clear, Polycarbonate lens, Chrome-plated brass, with Hood over light; 3-11/16" x 2-7/8" x 2-1/8"; 10 /Pack	3-11/16" x 2-7/8" x 2-1/8"	Chrome-plated brass	

STOP, TURN & TAIL LAMPS

- Mounting pad and lens gasket included (where needed)



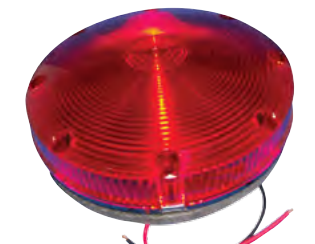
00744-2668B



00744-2165B



00744-26-240B



00744-2655B

Table 17-11: Incandescent Stop, Turn & Tail Lamps

Part Number	Description	Measurements (L/ W/ H or Diam/ H)	Housing	Lens
-------------	-------------	-----------------------------------	---------	------

ROUND PARK & TURN SIGNAL

00744-2165B	Amber, Double Optics ; Acrylic; Steel housing. Surface mounted design; 1 Wire Terminal. 7" x 2-3/16"	7" x 2-3/16"	Steel	Acrylic
00744-26-240B	Red, with Connectors; Acrylic; Steel housing. Surface mounted design; 1 Wire Terminal. Blue Bird Aftermarket. 7" x 2-3/16"	7" x 2-3/16"	Steel	Acrylic

Part Number	Description	Measurements (L/ W/ H or Diam/ H)	Housing	Lens
00744-2655B	Red, 2 Wire Terminal; Acrylic; Steel housing. Surface mounted design; Blue Bird Aftermarket. 7" x 2-3/16"	7" x 2-3/16"	Steel	Acrylic
00744-2668B	Red, 2 Wire Terminal; Double Optic; Acrylic; Steel housing. Surface mounted design; 7" x 2-3/16"	7" x 2-3/16"	Steel	Acrylic
0744-21-240B	Amber, with Connector; OE; Heavy-gauge ground strap. 1 Wire Terminal; 7-1/16" diameter x 2" high.	7-1/16" x 2"		
00744-21-245B	Amber, with Ground and Connector; OE; 2 Wire Terminal; 7-1/16" diameter x 2"	7-1/16" x 2"		

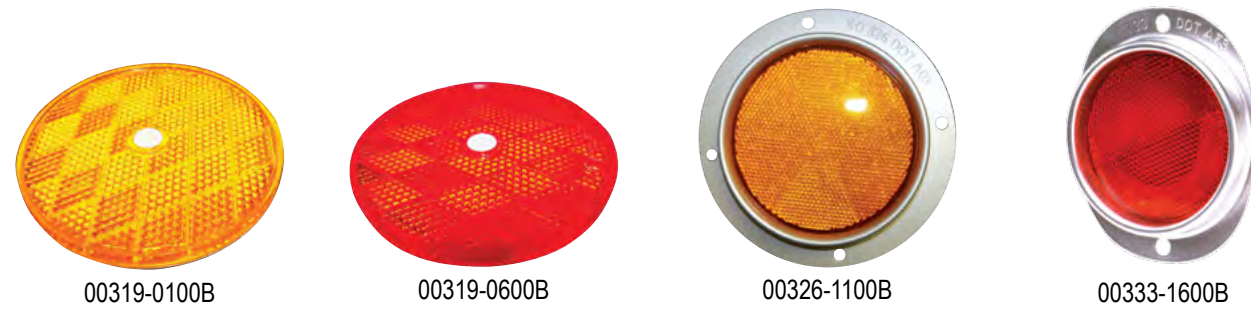
BACKUP/REVERSE LAMPS

- OE-style lamp
- Downward slanted socket for access and wiring.



Table 17-12: Incandescent Backup Lamps

Part Number	Description	Measurements (L/ W/ H or Diam/ H)	Housing	Lens
ROUND REVERSE LIGHT				
00744-2501B	Moonstone (White); OE; Heavy-gauge ground strap; 1 Wire Terminal; 7-1/16" x 2"	7-1/16" x 2"		
00744-25-240B	Moonstone (White); OE; with Connections; Heavy-gauge ground strap; 1 Wire Terminal; 7-1/16" x 2"	7-1/16" x 2"		
00852-2301B	Clear, OE-style; 3.87" Diam.; Bulb #1156. 3-7/8" x 1-17/32"	3-7/8" x 1-17/32" width		
00852-23-240B	Clear, OE-style (AmTran); Bulb #1156. 2 Wire Terminal with Connector; 3-7/8" x 1-17/32"	3-7/8" x 1-17/32" width		
00852-23-250B	Clear, OE-style (AmTran); 2 Wire Terminal with Ground and Connector; 3-7/8" x 1-17/32"	3-7/8" x 1-17/32" width		
00852-23-940B	Clear, OE-style (AmTran); 1 Wire Terminal with Connector; 3-7/8" x 1-17/32"	3-7/8" x 1-17/32" width		



REFLECTORS

Table 17-13: Incandescent Reflectors

Part Number	Description	Measurements (L/ W/ H or Diam/ H)	Housing	Lens
00319-0100B	Amber (Front or Rear Engine Platform); Sealed reflector mount with screw through bushed 3.25" center hole.	3-3/16", 3.25" Center Hole		
00319-0600B	Red, Sealed reflector mount with screw through bushed 3.25" center hole.	3-3/16", 3.25" Center Hole		
00326-1100B	Amber, 4" Aluminum, Acrylic lens recessed into housing 3/16"; Mounted in a 2-piece heavy gauge steel housing; Aluminum powder-coated; 5-1/8" x 5/8" deep body.	5-1/8" x 5/8" deep body	Steel	Acrylic
00333-1600B	Red, 3" Steel ; Acrylic lens recessed into housing 5/16"; Mounted in a 2-piece heavy gauge stamped steel oval housing; Aluminum powder-coated; 4-1/2" x 3-5/8" x 5/8"	4-1/2" x 3-5/8" x 5/8" deep body	Steel	Acrylic

LENSES

- Refractions designed to amplify lighting.

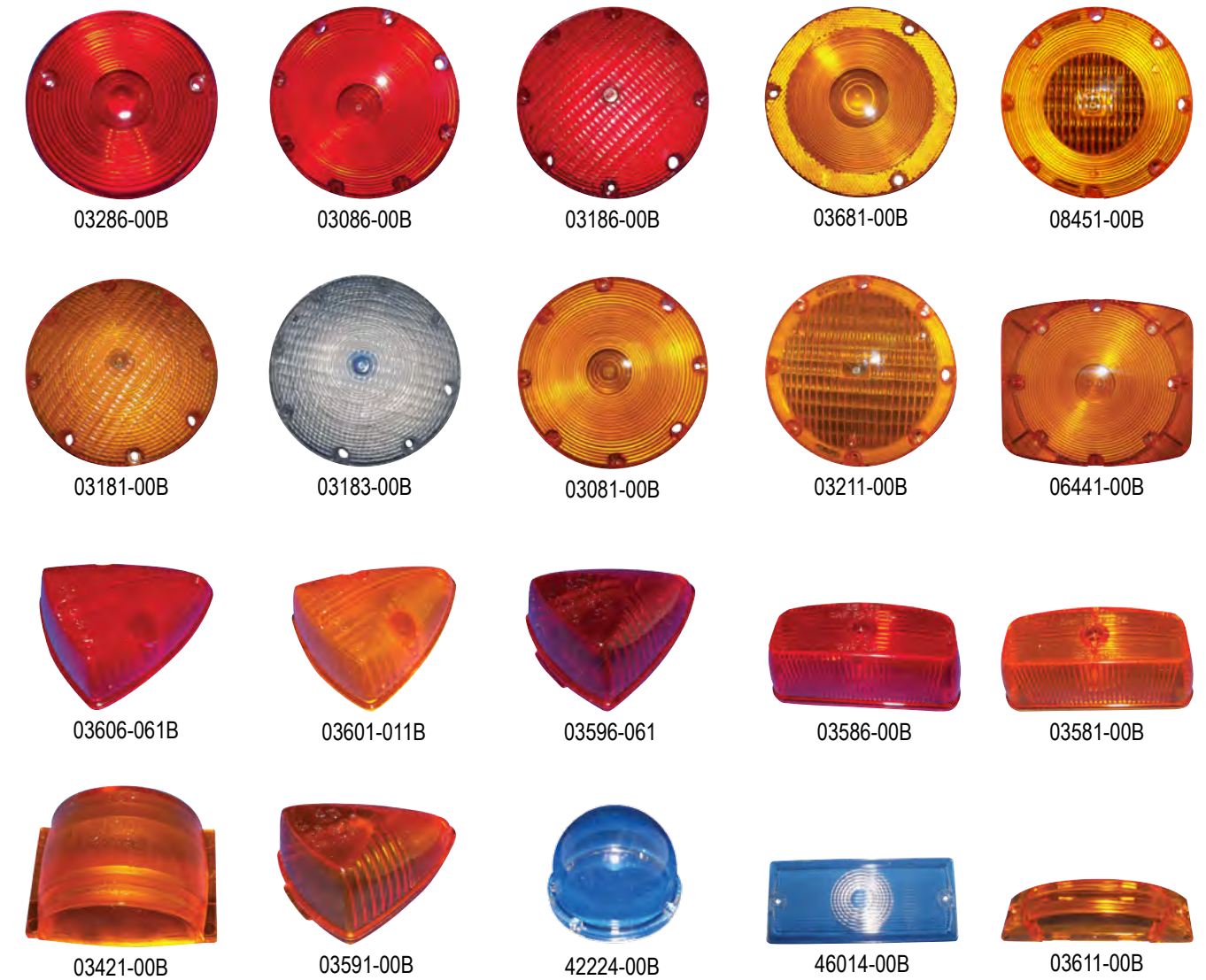
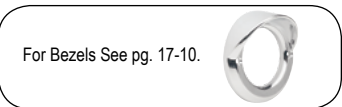


Table 17-14: Incandescent Lenses

Part Number	Description	Lens Material
7" ROUND LENSES		
03081-00B	Amber, Lens 744, 7", Acrylic	Acrylic
03085-00B	Moonstone (White) Lens, 7" Acrylic	Acrylic
03086-00B	Red, Lens 744, 7", Acrylic	Acrylic
03181-00B	Amber, Lens 744, 7", Double Optics	
03183-00B	Clear, Lens 744, 7", Double Optics	
03186-00B	Amber, Lens 744, 7", Double Optics	

Part Number	Description	Lens Material
-------------	-------------	---------------

7.06" ROUND LENSES

03211-00B	Amber, Lens 745, 7.06" Diameter, Acrylic	Acrylic
08451-00B	Amber, Lens 845, 7.06" Diameter	
08456-00B	Red, Lens 845, 7.06" Diameter	

ROUND LENS (OLD STYLE)

03286-00B	Red, Lens 200, 3.97" Diameter, Old Style	
-----------	--	--

LARGE SCONCE LENSES

03421-00B	Amber, 2-1/2" x 19/16" x 1-1/16", Lens 541	
-----------	--	--

LARGE BLOCK RECTANGLE LENSES

03581-00B	Amber, Lens 556, Acrylic, 3-3/16" x 1-7/16" x 1-11/16", 10 /Pack	Acrylic
03586-00B	Red, Lens 556, Acrylic, 3-3/16" x 1-7/16" x 1-11/16", 10/Pack	Acrylic

LARGE WEDGE LENSES

03591-00B	Amber, Lens 555 Interior Mount, Acrylic, 2-3/4" x 3-5/8" x 1-1/2", 10 /Pack	Acrylic
03596-061	Red, Lens 555, Interior Mount, Acrylic, 2-3/4" x 3-5/8" x 1-1/2", 10 /Pack	Acrylic
03601-011B	Amber, Lens 555, 3-Screw Mount, Acrylic, 2-3/4" x 3-5/8" x 1-1/2", 10 /Pack	Acrylic
03606-061B	Red, Lens 555, 3-Screw Mount, Acrylic, 2-3/4" x 3-5/8" x 1-1/2", 10 /Pack	Acrylic
03611-00B	Amber, Lens 500, Protective bulb hard-coating, Brush Guard, 4-3/8" x 1-1/4" x 1-3/8"	Acrylic

LARGE ROUND LENSES WITH REFLECTORS

03681-00B	Amber, Lens/Reflector 772, 5.18" Diameter, Acrylic	Acrylic
03686-00B	Red, Lens/Reflector 772, 5.18" Diameter, Acrylic	Acrylic

LARGE SQUARE LENSES

06441-00B	Amber, Lens 644, 7.0" x 8.0"	
-----------	------------------------------	--

SMALL CLEAR BUBBLE LENSES

42224-00B	Clear, Lens 856, 2.50" Diameter, 10 /Pack, Blue Bird Aftermarket	
-----------	--	--

LARGE RECTANGLE CLEAR LENSES

46120-00B	Clear, Lens 596, Polycarbonate (replacement for Blue Bird and AmTran) 2 mounting holes; 6-7/8" x 3-1/8"	Polycarbonate
46014-00B	Clear, Lens 596, Acrylic, No Branded NamePlate, 6-7/8" x 3-1/8"	

HALOGEN LAMPS**FLOOD LAMPS**

- Designed for construction, agriculture and heavy-duty applications.
- Unit made of glass-filled nylon.
- 55-watt H3 halogen bulb with a clear lens.
- Universal bracket with 90° up/30° down rotation from vertical.

Table 17-15: Halogen Flood Lamps

Part Number	Description	Measurements (L/ W/ H or Diam/ H)	Lens	Body
-------------	-------------	---	------	------

HALOGEN UTILITY FLOOD LIGHT KITS

00810-23411	Clear, Glass-filled nylon; 55-watt H3 halogen bulb; 6-3/4" x 4-1/2" x 3-3/4"	6-3/4" x 4-1/2" x 3-3/4"	Clear	Steel
-------------	--	--------------------------	-------	-------

WARNING LAMPS

- Flat back warning lamp, 55-watt quartz, plug-in halogen bulb.
- Draws 30% less current and has 20% longer life than old incandescent bulbs.
- More effective in bright sunlight.
- Can be retrofitted on older model buses. Body has a Black powder-coated finish, over galvanized steel.



Table 17-16: Halogen Warning Lamps

Part Number	Description	Measurements (L/ W/ H or Diam/ H)	Lens	Body
-------------	-------------	---	------	------

WARNING LIGHTS

00845-21-241B	Amber, Halogen, 2 Wire Terminal; Bulb #H3-55. Steel Body; 7-1/16" x 1-7/8"	7-1/16" x 1-7/8"	Amber	Steel
00845-26-241B	Red, Halogen, 2 Wire Terminal; 55-watt quartz, plug-in bulb. Bulb #H3-55. Steel Body; 7-1/16" x 1-7/8"	7-1/16" x 1-7/8"	Red	Steel
00845-26-240B	Red, Halogen, 1 Wire Terminal; 55-watt quartz, plug-in bulb. Bulb #H3-55. Steel Body; 7-1/16" x 1-7/8"	7-1/16" x 1-7/8"	Red	Steel

HEADLAMP BULBS

HALOGEN BULBS

Table 17-17: Halogen Headlamp Bulbs

Part Number	Description	Quantity
10695-055	Seal beam H3 Bulb for 7" round red or yellow warning lights, 12 Volt, 55 Watt	10 / pack

HEADLAMP ASSEMBLIES & MOUNTING ACCESSORIES



HEADLAMP ASSEMBLIES

Table 17-18: Headlamp Assemblies

Part Number	Description	Size	Location
HEADLIGHT BODY/BUCKET			
92872-00B	Large Rectangle Headlight Assembly Body/ Inner Plastic Bucket	Large - Rectangle	
SMALL HEADLIGHT ASSEMBLIES			
00931-0301	Small Headlight Assembly, Hi or Lo Beam Position, DOT standard 2A1 location	Small - Dual	2A1
499-4130101	Small Rectangle Right Hand Dual Headlight Assembly, with Halogen Bulb - uses #4651 & #4656 Halogen Bulbs, without Bezel, 22" cable, Black, Red, Green with 220 Series Packard Connector	Small - Dual	Right Hand
499-4130201	Small Rectangle Right Hand Dual Headlight Assembly, with Halogen Bulb - uses #4651 & #4656 Halogen Bulbs, without Bezel, 22" cable, Black, Red, Green with 280 Series Packard Connector	Small - Dual	Right Hand
499-4113301	Small Rectangle Right Hand Dual Headlight Assembly, with Halogen Bulb - uses #4651 & #4656 Halogen Bulbs, with Chrome Bezel, 26" cable, Green, Black, White with 220 Series Packard Connector	Small - Dual	Right Hand
499-4113311	Small Rectangle Left Hand Dual Headlight Assembly, with Halogen Bulb - uses #4651 & #4656 Halogen Bulbs, with Chrome Bezel, 26" cable, Green, Black, White with 220 Series Packard Connector	Small - Dual	Left Hand
499-4114301	Small Rectangle Left Hand Dual Headlight Assembly, with Halogen Bulb - uses #4651 & #4656 Halogen Bulbs, with Chrome Bezel, 26" cable, Green, Black, White with No Connector	Small - Dual	Left Hand
499-4130111	Small Rectangle Left Hand Dual Headlight Assembly, with Halogen Bulb - uses #4651 & #4656 Halogen Bulbs, without Bezel, 22" cable, Black, Red, Green with 220 Series Packard Connector	Small - Dual	Left Hand
499-4130211	Small Rectangle Left Hand Dual Headlight Assembly, with Halogen Bulb - uses #4651 & #4656 Halogen Bulbs, without Bezel, 22" cable, Black, Red, Green with 280 Series Packard Connector	Small - Dual	Left Hand
499-4157001	Small Rectangle Right Hand Dual Headlight Assembly, Left Hand Rule, with Halogen Bulb - uses Hella Reflector and Bulbs, without Bezel, 22" cable, Green, Black, White with No Connector	Small - Dual	Right Hand
499-4157011	Small Rectangle Left Hand Dual Headlight Assembly, Left Hand Rule, with Halogen Bulb - uses Hella Reflector and Bulbs, without Bezel, 22" cable, Green, Black, White with No Connector	Small - Dual	Left Hand

All Small Rectangle Dual Headlight assemblies are Right Hand Rule unless noted otherwise.

Part Number	Description	Size	Location
-------------	-------------	------	----------

LARGE ROUND HEADLIGHT ASSEMBLIES

499-1011911	Large Round Right Hand Headlight Assembly, with Halogen Bulb	Large - Round	Right Hand
499-1011901	Large Round Left Hand Headlight Assembly, with Halogen Bulb	Large - Round	Left Hand

LARGE RECTANGLE HEADLIGHT ASSEMBLIES

499-3014591	Large Rectangle Headlight Assembly in a Nylon Housing, with Halogen Bulb	Large - Rectangle	
499-301462NB	Large Rectangle Headlight Assembly without BEZEL, with Halogen Bulb	Large - Rectangle	
499-3014621	Large Rectangle Headlight Assembly with BEZEL, with Halogen Bulb	Large - Rectangle	
499-3154211	Large Rectangle Headlight Assembly; with Cable, Bulb: 5" X 7"	Large - Rectangle	
499-3054741	Large Rectangle Headlight Assembly in a Nylon Housing, with Halogen Bulb	Large - Rectangle	

All Small Rectangle Dual Headlight assemblies are Right Hand Rule unless noted otherwise.



MOUNTING ACCESSORIES

Table 17-19: Headlamp Bezels, Gaskets & Nests

Part Number	Description
-------------	-------------

BEZELS

410-4112041	Bezel, Small, Dual, Chrome
447-3022151	Bezel, Large Rectangle with Screws

GASKETS

37879-00B	Gasket, Lens 210/211/722/854
420-3020411	Gasket, Exterior Light, 10 /pack
430-3012111	Retainer Ring Large Rectangle
45883-00B	Mounting Pad/ Gasket for Cab (Clearance) Marker, 555 Shield

NESTS

427-3026221	Nest for Large Rectangular Headlight, Adjustment Ears set to 9 o'clock, 12 o'clock and 3 o'clock
427-4095211	Nest for Sealed Beam Bulb, Stamped Galvanized Steel, Small Rectangle, Adjustment Ears set to 9 o'clock and 12 o'clock

BUS APPLICATIONS FOR LIGHTING

BUS APPLICATIONS FOR LIGHTING

BLUE BIRD

Table 17-20: Lighting - Blue Bird

OE Part Number	Part Number
00014581	00200-2601B
00214670	00319-0100B
02146710	00319-0100B
02146702	00319-0600B
01481290	00333-1600B
01135649	00500-01-637B
01280601	00500-01-637B
01281369	00500-06-637B
00107168	00529-1344B
01228451	00541-1603B
00105521	00543-53-602B
00082819	00555-9155B
00082820	00555-9155B
00103205	00563-01-535B
00103214	00563-06-535B
01257997	00596-00-047B
00011383	00596-00-048B
00817098	00744-2165B
0817098	00744-2165B
00025926	00744-2501B
00857656	00744-2668B
00099737	00744-91-010B
00099738	00744-96-010B
00031978	00845-21-241B

OE Part Number	Part Number
00031979	00845-26-241B
00098402	00852-2301B
00099776	00853-93-701B
01719293	00856-33-240B
03945268	00931-0301
04326146	03081-00B
04311775	03085-00B
04326153	03086-00B
02130516	03183-00B
003286-00B	03286-00B
04288080	03421-00B
04306031	03611-00B
02104099	03681-00B
02104081	03686-00B
00071188	08451-00B
00071190	08456-00B
00047639	10695-055
08307662	10695-055
02146173	37879-00B
04286969	410-4112041
04304143	427-3026221
00102623	427-4095211
02157253	430-3012111
02157238	447-3022151
043613-30	447-3022151
01125491	45883-00B
01258003	46120-00B
01644533	499-3014591
01746643	499-3054741
00040832	499-4113301
00040833	499-4113311
00025624	499-4114301
00025625	499-4114301
00027994	499-4130101
00027995	499-4130111
00025628	499-4130201
00025629	499-4130211
00044141	499-4157001

OE Part Number	Part Number
00044142	499-4157011
02157261	92872-00B

INTERNATIONAL/IC BUS

Table 17-21: Lighting - International/IC Bus

OE Part Number	Part Number
92808000	00326-1100B
433259001	00529-13-240B
3884912C91	00529-1319B
433254001	0744-21-240B
2230585C1	00744-21-245B
2210996C91	00845-26-240B
433261001	00852-23-240B
2230586C1	00852-23-250B
433261003	00852-23-940B
433257001	00856-33-240B
90201000	00909-0000B
2013807C91	499-3154211
5788	499-8060011

THOMAS BUILT

Table 17-22: Lighting - Thomas Built

OE Part Number	Part Number
148023	00810-23411
148011	420-3020411
53003373	499-1011901
53003707	499-1011911
52001886	499-3014621
52001886	499-301462NB



*For information, updates, or corrections,
please contact us at TRPBus@TRPParts.com*

*No part of this marketing material may be
reproduced in any manner without written
permission from TRP® North America.*

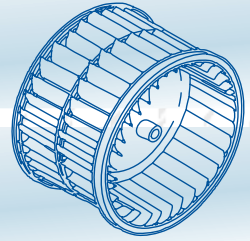
TRP® North America

750 Houser Way N.
Renton, WA 98057

www.trpparts.com



Parts for all brands of buses.



18

BUS PARTS

HVAC

*Proven, reliable and
always innovative.*

TRP® offers reliable
aftermarket products
that are designed
and tested to exceed
customers' expectations
regardless of the bus
make, model or age.



COMPRESSORS • BLOWER MOTORS • BLOWER
WHEELS • PUMPS • FANS • HEATER CORES



BUS PARTS

Tested. Reliable. Guaranteed.

HVAC

Choosing the right replacement part or service for your vehicle—whether you own one, or a fleet—is one of the most important decisions you can make for your business. And, with tested TRP® parts it's an easy decision.

Regardless of the make you drive, TRP® quality replacement parts are engineered to fit your truck, trailer or bus. Choose the parts that give you the best value for your business. Check them out at an approved TRP® retailer near you.

The cross reference information in this catalog is based upon data provided by several industry sources and our partners. While every attempt is made to ensure the information presented is accurate, we bear no liability due to incorrect or incomplete information.

Product Availability

Due to export restrictions and market demands, not all products are always available in every location. Check for availability in your area with your local TRP® Distributor.

No part of this marketing material may be reproduced in any manner without written permission from TRP® North America.

CONTENTS

COMPRESSORS

<u>Heavy Duty Transit Bus HVAC</u>	18-4
TM16 Series - Ear Mount	18-4
TM16 Series - Direct Mount	18-5
TM21 Series - Direct Mount	18-6
TM31 Series - Direct Mount	18-7

BLOWER MOTORS

<u>Single Shaft Blower Motors</u>	18-8
<u>Double Shaft Blower Motors</u>	18-12

BLOWER WHEELS

<u>Double Entry Blower Wheels</u>	18-13
---	-------

BOOSTER PUMPS

<u>Booster Pump Motors</u>	18-14
<u>Booster Pumps</u>	18-14

DEFROST FANS

<u>24v and12v Defrost Fans</u>	18-15
--------------------------------------	-------

TRP® North America

750 Houser Way N.
Renton, WA 98057

www.trpparts.com

HEATER CORES

<u>Heater Cores</u>	18-16
---------------------------	-------

FILTERS

<u>Air Filters</u>	18-17
--------------------------	-------

WATER VALVES

<u>Manual Valves</u>	18-18
<u>Cable-Controlled Valves</u>	18-18

BUS APPLICATIONS FOR HVAC

A.R. Lintern	18-19
Amtram	18-19
Bluebird	18-19
IHC	18-19
Kysor	18-19
Navistar	18-19
Superior	18-19
Thomas Built	18-19

CROSS REFERENCE

QUE	18-20
Seltec/Valeo	18-20
TransAir	18-20
Carrier	18-20
MEI	18-20
ThermoKing	18-20

COMPRESSORS

HEAVY DUTY TRANSIT BUS HVAC

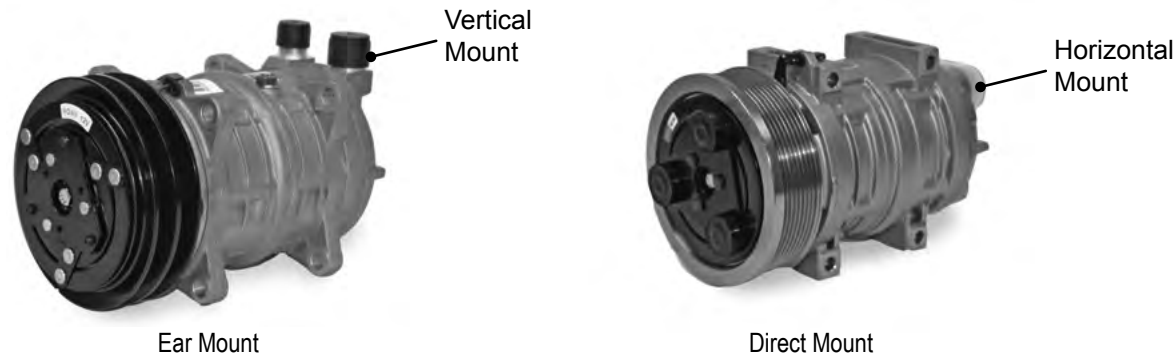


Table 18-1: HVAC - Transit Bus TM16 Series

Part Number	Description	Mount Style	Fitting Description (V=Vertical H=Horizontal)	Pulley Diameter (mm)	Pulley Type	Voltage
TM16 SERIES - EAR MOUNT						
LE1180	Transit Bus HVAC Compressor - 163cc (9.95 cu inch) displacement per revolution - Ear Mount	Ear	V- 3/4" x 7/8"	135	2A	12
LE1186	Transit Bus HVAC Compressor - 163cc (9.95 cu inch) displacement per revolution - Ear Mount	Ear	H - 3/4" x 7/8"	135	2A	12
LE1197	Transit Bus HVAC Compressor - 163cc (9.95 cu inch) displacement per revolution - Ear Mount	Ear	H - 3/4" x 7/8"	123	8PV	12
LE1348	Transit Bus HVAC Compressor - 163cc (9.95 cu inch) displacement per revolution - Ear Mount	Ear	H - 3/4" x 7/8"	123	6PV	12
LE1596	Transit Bus HVAC Compressor - 163cc (9.95 cu inch) displacement per revolution - Ear Mount	Ear	H - 3/4" x 7/8"	135	2A	12
LE1198	Transit Bus HVAC Compressor - 163cc (9.95 cu inch) displacement per revolution - Ear Mount	Ear	H-Pad	135	2A	12
LE1206	Transit Bus HVAC Compressor - 163cc (9.95 cu inch) displacement per revolution - Ear Mount	Ear	H-Pad	123	8PV	12
LE1357	Transit Bus HVAC Compressor - 163cc (9.95 cu inch) displacement per revolution - Ear Mount	Ear	H-Pad	123	6PV	12
LE1616	Transit Bus HVAC Compressor - 163cc (9.95 cu inch) displacement per revolution - Ear Mount	Ear	H-Pad	123	8PV	12
LE1705	Transit Bus HVAC Compressor - 163cc (9.95 cu inch) displacement per revolution - Ear Mount	Ear	H-Pad	123	10PV	12
LE1184	Transit Bus HVAC Compressor - 163cc (9.95 cu inch) displacement per revolution - Ear Mount	Ear	V- 3/4" x 7/8"	123	6PV	12

Note: Pulley Types:

Example: 2A
 2 = number of grooves
 A = type of groove

A = V-Belt
 PV = Poly-V or Serpentine Belt

Part Number	Description	Mount Style	Fitting Description (V=Vertical H=Horizontal)	Pulley Diameter (mm)	Pulley Type	Voltage
LE1195	Transit Bus HVAC Compressor - 163cc (9.95 cu inch) displacement per revolution - Ear Mount	Ear	V- 3/4" x 7/8"	123	8PV	12
LE1472	Transit Bus HVAC Compressor - 163cc (9.95 cu inch) displacement per revolution - Ear Mount	Ear	V- 3/4" x 7/8"	135	2A	12

TM16 SERIES - DIRECT MOUNT

LE1641	Transit Bus HVAC Compressor - 163cc (9.95 cu inch) displacement per revolution - Direct Mount	Direct	V- 3/4" x 7/8"	123	8PV	12
LE1672	Transit Bus HVAC Compressor - 163cc (9.95 cu inch) displacement per revolution - Direct Mount	Direct	V- 3/4" x 7/8"	135	2A	12
LE1677	Transit Bus HVAC Compressor - 163cc (9.95 cu inch) displacement per revolution - Direct Mount	Direct	H- 3/4" x 7/8"	123	8PV	12
LE1686	Transit Bus HVAC Compressor - 163cc (9.95 cu inch) displacement per revolution - Direct Mount	Direct	H-Pad	135	2A	12
LE1687	Transit Bus HVAC Compressor - 163cc (9.95 cu inch) displacement per revolution - Direct Mount	Direct	H-Pad	123	8PV	12
LE1716	Transit Bus HVAC Compressor - 163cc (9.95 cu inch) displacement per revolution - Direct Mount	Direct	3/4" x 7/8"	123	10PV	12
LE1717	Transit Bus HVAC Compressor - 163cc (9.95 cu inch) displacement per revolution - Direct Mount	Direct	H-Pad	123	8PV	12
LE1719	Transit Bus HVAC Compressor - 163cc (9.95 cu inch) displacement per revolution - Direct Mount	Direct	H - 3/4" x 7/8"	135	2A	12

Note: Pulley Types:

Example: 2A
 2 = number of grooves
 A = type of groove

A = V-Belt
 PV = Poly-V or Serpentine Belt



Direct Mount

Table 18-2: HVAC - Transit Bus - TM21 Series

Part Number	Description	Mount Style	Fitting Description	Pulley Diameter (mm)	Pulley Type	Voltage	Note
-------------	-------------	-------------	---------------------	----------------------	-------------	---------	------

TM21 SERIES - DIRECT MOUNT

LE1562	Transit Bus HVAC Compressor - 215cc (13 cu inch) displacement per revolution - Direct Mount	Direct	H-Pad	141	8PV	12	
LE1564	Transit Bus HVAC Compressor - 215cc (13 cu inch) displacement per revolution - Direct Mount	Direct	H-Pad	145	2A	12	
LE1657	Transit Bus HVAC Compressor - 215cc (13 cu inch) displacement per revolution - Direct Mount	Direct	H-Pad	127	8PV	12	49mm Gauge Line
LE1700	Transit Bus HVAC Compressor - 215cc (13 cu inch) displacement per revolution - Direct Mount	Direct	H-Pad	127	10PV	12	49mm Gauge Line
LE1731	Transit Bus HVAC Compressor - 215cc (13 cu inch) displacement per revolution - Direct Mount	Direct	H-Pad	127	10PV	12	49mm Gauge Line
LE1733	Transit Bus HVAC Compressor - 215cc (13 cu inch) displacement per revolution - Direct Mount	Direct	H-Pad	145	2A	12	

Note: Pulley Types:

Example: 2A
 2 = number of grooves
 A = type of groove
 A = V-Belt
 PV = Poly-V or Serpentine Belt



Direct Mount

Table 18-3: HVAC - Transit Bus - TM31 Series

Part Number	Description	Mount Style	Fitting Description	Pulley Diameter (mm)	Pulley Type	Voltage
-------------	-------------	-------------	---------------------	----------------------	-------------	---------

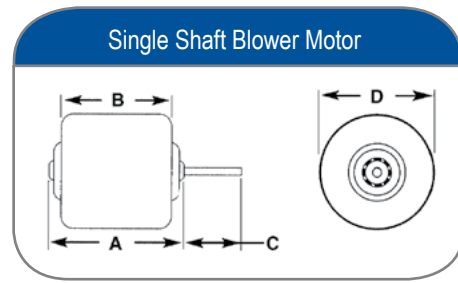
TM31 SERIES - DIRECT MOUNT

LE1209	Transit Bus HVAC Compressor - 313cc (19.1 cu inch) displacement per revolution - Direct Mount	Direct	1-1/6" x 7/8" Bolt	152	2A	12
LE1211	Transit Bus HVAC Compressor - 313cc (19.1 cu inch) displacement per revolution - Direct Mount	Direct	1-1/6" x 7/8" Bolt	152	2B	12
LE1213	Transit Bus HVAC Compressor - 313cc (19.1 cu inch) displacement per revolution - Direct Mount	Direct	1-1/6" x 7/8" Bolt	152	8PV	12
LE1702	Transit Bus HVAC Compressor - 313cc (19.1 cu inch) displacement per revolution - Direct Mount	Direct	1-1/6" x 7/8" Bolt	152	10PV	12

Note: Pulley Types:

Example: 2A
 2 = number of grooves
 A = type of groove
 A = V-Belt
 PB = Poly-V or Serpentine Belt

BLOWER MOTORS



SINGLE SHAFT BLOWER MOTORS

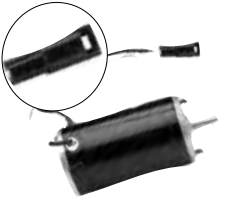

Table 18-4: Blower Motors- Single Shaft

Product	Part Number	Description	Speed	Voltage	Rotation	Mount	Available Vent	Dim. A	Dim. B	Dim. C	Dim. D	Shaft Diam.
	HA11250	Single Shaft Blower Motor, 1 Speed, CW	1	12	CW	Stud	Vented	n/a	3-5/8"	1-1/4"	3"	5/16"
	HA11550	Single Shaft Blower Motor, 1 Speed, CCW	1	12	CCW	Stud	Vented	n/a	3-5/8"	1-1/2"	3"	5/16"
	HA15750	Single Shaft Blower Motor, 2 Speed, CW	2	12	CW	Stud	Non-vented	3-11/32"	2-17/32"	1-1/8"	3"	1/4"
	HA15950	Single Shaft Blower Motor, 2 Speed, CW	2	12	CW	Stud	Vented	4-3/8"	3-1/2"	1-5/16"	3"	5/16"
	HA18050	Single Shaft Blower Motor, 2 Speed, CW	2	12	CW	Stud	Vented	4-3/8"	3-1/2"	1-5/16"	3"	5/16"
	HA18500	Single Shaft Blower Motor, 2 Speed, CW	2	12	CW	Stud	Vented	4-3/16"	3-35/64"	1"	3"	5/16"


Note: CW = Clockwise; CCW = Counter-Clockwise

Product	Part Number	Description	Speed	Voltage	Rotation	Mount	Available Vent	Dim. A	Dim. B	Dim. C	Dim. D	Shaft Diam.
	HA18550	Single Shaft Blower Motor, 1 Speed, CW	1	12	CW	Stud	Non-vented	4"	3-51/64"	1-17/32"	3"	5/16"
	HA19500	Single Shaft Blower Motor, 2 Speed, CW	2	12	CW	Stud	Non-vented	3-11/32"	2-1/2"	1"	3"	1/4"
	HA19600	Single Shaft Blower Motor, 1 Speed, CW/CCW	1	12	CW/CCW	Strap	Vented	4-3/8"	3-15/32"	1-17/32"	3"	5/16"
	HA19650	Single Shaft Blower Motor, 1 Speed, CW/CCW	1	12	CW/CCW	Stud	Vented	6-13/64"	3-21/32"	1-17/32"	3"	5/16"
	HA19700	Single Shaft Blower Motor, 2 Speed, CW	2	12	CW	Stud	Vented	4-19/32"	3-17/32"	1"	3"	5/16"
	HA19800	Single Shaft Blower Motor, 2 Speed, CCW	2	12	CCW	Stud	Vented	4-21/32"	3-15/16"	1-1/4"	3"	5/16"
	HA21750	Single Shaft Blower Motor, 2 Speed, CW	2	12	CW	Stud	Vented	4-1/2"	3-5/8"	1-5/16"	3"	5/16"

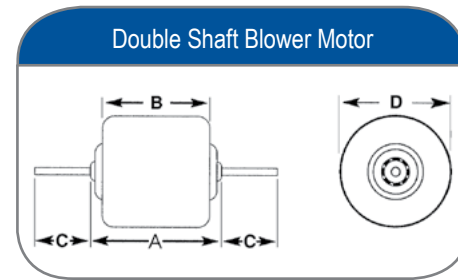
Note: CW = Clockwise; CCW = Counter-Clockwise

Product	Part Number	Description	Speed	Voltage	Rotation	Mount	Available Vent	Dim. A	Dim. B	Dim. C	Dim. D	Shaft Diam.
	HA21800	Single Shaft Blower Motor, 1 Speed, CCW	1	12	CCW	Stud	Vented	6-17/32"	4-17/32"	1-17/32"	3"	5/16"
	HA21850	Single Shaft Blower Motor, 1 Speed, CW	1	12	CW	Stud	Vented	6-17/32"	4-17/32"	1-17/32"	3"	5/16"
	HA21900	Single Shaft Blower Motor, 1 Speed, CCW	1	12	CCW	Strap	Vented	n/a	5-1/3"	1-1/3"	3-1/5"	5/16"
	HA22000	Single Shaft Blower Motor, 2 Speed, CW/CCW	2	12	CW/CCW	Case-bolt	Non-vented	3-7/8"	3-1/8"	1-9/16"	3"	5/16"
	HA22050	Single Shaft Blower Motor, 2 Speed, CW	2	12	CW	Stud	Non-vented	5-15/16"	3-35/64"	1-5/16"	3"	5/16"
	HA22100	Single Shaft Blower Motor, 2 Speed, CCW	2	12	CCW	Stud	Vented	5-15/16"	3-35/64"	7/8"	3"	5/16"
Image Not Available	HA22150	Single Shaft Blower Motor, 2 Speed, CCW	2	12	CCW	Stud	Non-vented	4-17/64"	2-39/64"	1/2"	3"	1/4"

Note: CW = Clockwise; CCW = Counter-Clockwise

Product	Part Number	Description	Speed	Voltage	Rotation	Mount	Available Vent	Dim. A	Dim. B	Dim. C	Dim. D	Shaft Diam.
	HA22200	Single Shaft Blower Motor, 2 Speed, CW/CCW	2	12	CW/CCW	Stud	Vented	5-19/32"	3-7/64"	1-13/32"	3"	5/16"
Image Not Available	HA22250	Single Shaft Blower Motor, 2 Speed, CCW	2	12	CCW	Stud	Vented	5-11/32"	3-23/64"	1"	3"	5/16"
Image Not Available	HA22300	Single Shaft Blower Motor, 2 Speed, CW	2	12	CW	Stud	Non-vented	4-49/64"	2-39/64"	1-7/64"	3"	1/4"

Note: CW = Clockwise; CCW = Counter-Clockwise



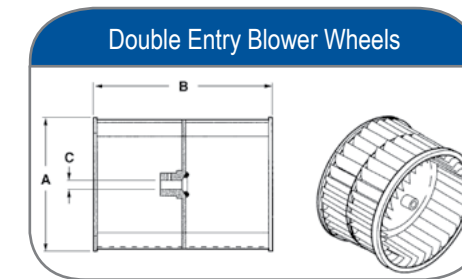
DOUBLE SHAFT BLOWER MOTORS

Table 18-5: Blower Motors - Double Entry

Product	Part Number	Description	Speed	Voltage	Rotation	Mount	Available Vent	Dim. A	Dim. B	Dim. C	Dim. D	Shaft Diam.
	HA21950	Double Shaft Blower Motor, 1 Speed, CCW	1	12	CCW	Strap	Vented	n/a	4-1/32"	1-1/2"	3"	5/16"
	HB10500	Double Shaft Blower Motor, 1 Speed, CCW	1	12	CCW	Strap	Vented	4-3/4"	3-7/8"	2-5/8"	3"	5/16"
	HB16250	Double Shaft Blower Motor, 1 Speed, CCW	1	12	CCW	Strap	Vented	5-9/32"	4-17/32"	2-9/32"	3"	5/16"
	HB16700	Double Shaft Blower Motor, 1 Speed, CCW	1	12	CCW	Strap	Vented	4-3/4"	3-15/16"	2-21/32"	3"	5/16"
	HB16800	Double Shaft Blower Motor, 1 Speed, CCW	1	12	CCW	Strap	Vented	5-9/32"	4-17/32"	2-7/8"	3"	5/16"

Note: CW = Clockwise; CCW = Counter-Clockwise

BLOWER WHEELS



DOUBLE ENTRY BLOWER WHEELS

Table 18-6: Blower Wheels - Double Entry

Part Number	Description	Rotation	Material	Diameter - A	Width - B	Bore Diameter - C
HC10050	Double Entry Blower Wheel, CW, Plastic	CW	Plastic	5-19/32"	3-15/32"	5-16"
HC10500	Double Entry Blower Wheel, CCW, Plastic	CCW	Plastic	4-17/32"	3-13/32"	5-16"
HC11850	Double Entry Blower Wheel, CCW, Steel	CCW	Steel	5-19/32"	3-1/8"	5-16"
HC14850	Double Entry Blower Wheel, CW, Steel	CW	Steel	5-1/2"	4-21/32"	5/16"
HC14900	Double Entry Blower Wheel, CW, Steel	CW	Steel	5-17/32"	5-5/8"	5/16"
HC16450	Double Entry Blower Wheel, CW, Steel	CW	Steel	5-3/4"	5"	5/16"
HC16500	Double Entry Blower Wheel, CCW, Steel	CCW	Steel	5-3/4"	5"	5/16"

BOOSTER PUMPS

BOOSTER PUMP MOTORS

Table 18-7: Booster Pump Motors

Part Number	Description	Speed	Voltage	Rotation	Mount	Available Vent	Dim. A	Dim. B	Dim. C	Dim. D	Diam.
HA1955	Booster Pump Motor, 1 Speed, CW	1	12	CW	Strap	Non-vented	4-3/4"	4-11/32"	1-3/8"	3"	5/16"
HA1975	Booster Pump Motor, 1 Speed, CCW	1	12	CCW	Stud	Vented	4-7/8"	4"	1-21/32"	3"	5/16"




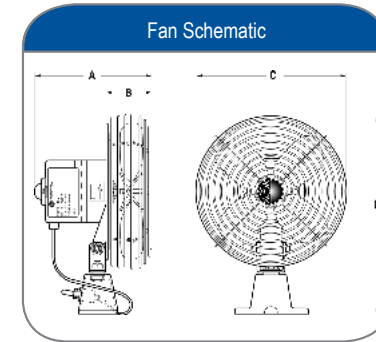
BOOSTER PUMPS

Table 18-8: Booster Pumps

Part Number	Description	Kysor Replacement Motor	OE Interchanges
RD1020	Booster Pump, 12v, 90° 1" Inlet Tube	HA1955	6123-0214
RD1060	Booster Pump, 12v, Straight 1" Inlet Tube	HA1955	6123-0214
RD1070	Booster Pump, 12v, 90° 1" Inlet Tube	n/a	6123-0214
RD1065	Booster Pump, 24v, Straight 1" Inlet Tube	n/a	6123-0214

DEFROST FANS

For Compressors See pg. 18-4. 



12V DEFROST FANS

Table 18-9: Defrost Fans - 12v

Part Number	Description	Speed	Voltage	Cage	Color	Base	Dim. A	Dim. B	Dim. C	Dim. D
HD11450	Defrost Fan, 2 Speed, 12v	2	12	Metal	Chrome	U Joint	4-31/32"	2-3/16"	7-7/16"	9-21/32"
HD11500	Defrost Fan, 2 Speed, 12v	2	12	Metal	Chrome	U Joint	4-31/32"	2-13/64"	7-1/2"	9-7/8"
HD12400	Defrost Fan, 2 Speed, 12v	2	12	Metal	Black	U Joint	5-5/16"	2-1/4"	7-1/2"	9-7/8"
HD12450	Defrost Fan, 2 Speed, 12v	2	12	Steel	Chrome with Black Base	U Joint	4-31/32"	2-3/16"	7-7/16"	9-21/32"
HD11500	Defrost Fan, 2 Speed, 12v	2	12	Metal	Chrome	U Joint	4-31/32"	2-13/64"	7-1/2"	9-7/8"
HD12400	Defrost Fan, 2 Speed, 12v	2	12	Metal	Black	U Joint	5-5/16"	2-1/4"	7-1/2"	9-7/8"
HD12450	Defrost Fan, 2 Speed, 12v	2	12	Steel	Chrome with Black Base	Plate	4-31/32"	2-1/4"	7-1/2"	11-1/4"

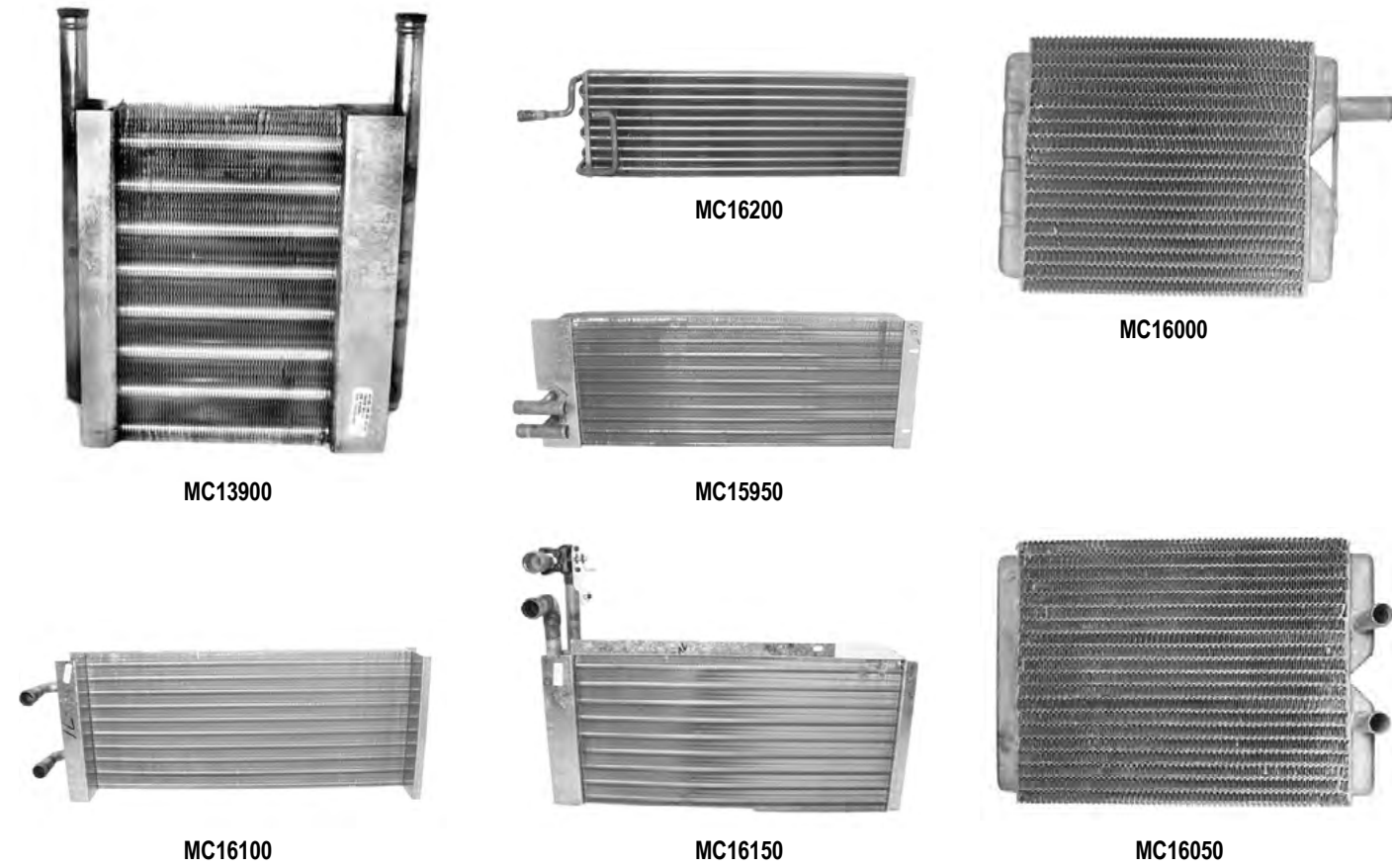


24V DEFROST FANS

Table 18-10: Defrost Fans - 24v

Part Number	Description	Speed	Voltage	Cage	Color	Base	Dim. A	Dim. B	Dim. C	Dim. D
HD10900	Defrost Fan, 2 Speed, 24v	2	24	Metal	Chrome	U Joint	5-5/16"	2-1/4"	7-1/2"	9-7/8"

HEATER CORES



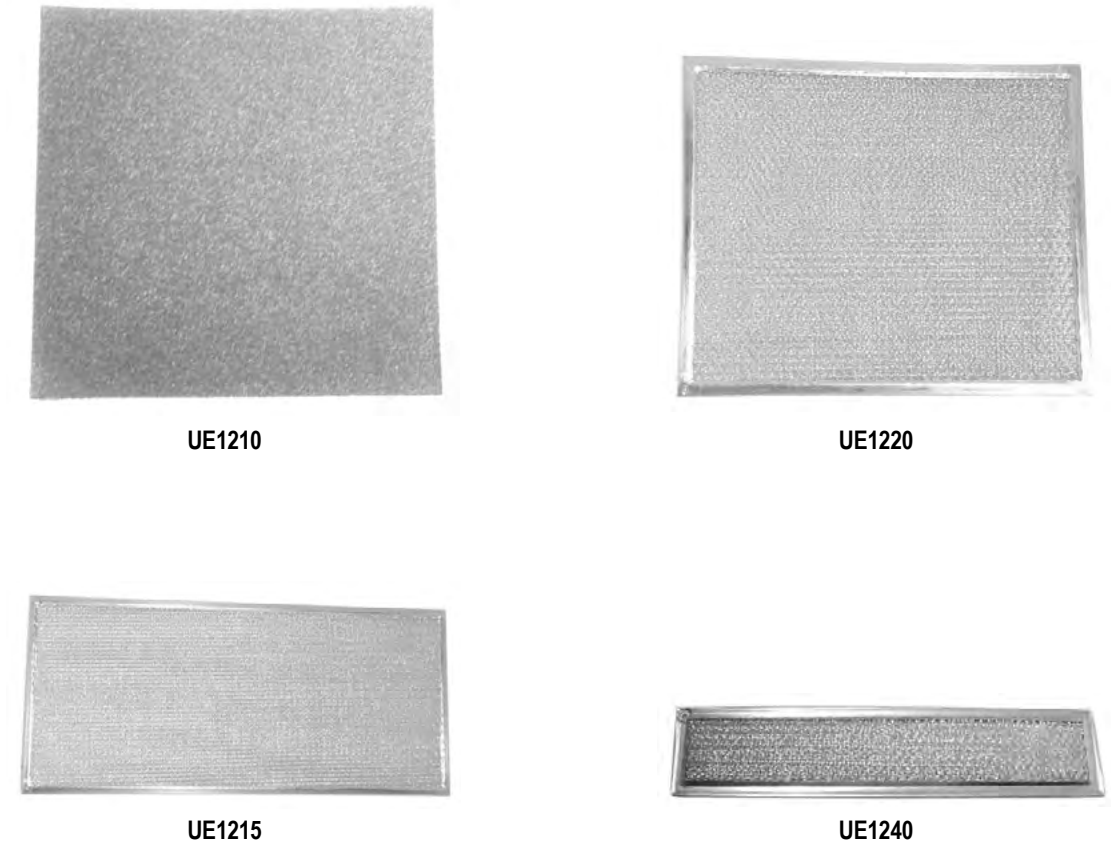
HEATER CORES

Table 18-11: Heater Cores

Part Number	Description	Width - A	Height - B	Length - C	OE Interchanges
MC13900	Heater Core	2-37/64"	8"	5-1/32"	8566-0129
MC15950	Heater Core	3-1/4"	10"	12-1/4"	8566-0244
MC16000	Heater Core	2-1/2"	12"	12-1/4"	8566-0296
MC16050	Heater Core	n/a	n/a	n/a	8566-0384
MC16100	Heater Core	1-3/4"	10"	22-3/4"	8566-0377
MC16150	Heater Core	4-1/4"	9-1/8"	18"	n/a
MC16200	Heater Core	2-19/32"	10"	30"	n/a

FILTERS

For Blower Wheels See pg. 18-13.



AIR FILTERS

Table 18-12: Air Filters

Part Number	Description	Height	Length	Thickness	OE Interchanges
UE1205	Recirculation Air Filter	7-3/32"	28-1/2"	1/4"	8566-0237
UE1210	Recirculation Air Filter	12-3/4"	12-15/16"	1/2"	n/a
UE1215	Recirculation Air Filter	10-1/4"	22-17/32"	1/4"	n/a
UE1220	Recirculation Air Filter	10-1/4"	12-1/4"	1/4"	8566-0385
UE1225	Recirculation Air Filter	9"	9"	5/8"	8566-0439
UE1230	Recirculation Air Filter	7-7/8"	8-3/4"	1/4"	n/a
UE1240	Fresh Air Filter	10-3/8"	33-5/64"	1/4"	n/a

WATER VALVES



MA1620

MA1625

MANUAL VALVES

Table 18-13: HVAC Manual Water Valves

Part Number	Description	OE Interchanges
MA1620	Elbow Water Valve - manual shutoff, 3/4" NPT x 3/4" NPT	8566-0156
MA1625	Straight Water Valve - manual shutoff, 3/4" NPT x 3/4" NPT	n/a

CABLE-CONTROLLED VALVES

Table 18-14: HVAC Cable-Controlled Water Valves

Part Number	Description	OE Interchanges
MA1635	Cable-Controlled Water Valve - 5/8" x 1", pull to open	8566-0776

BUS APPLICATIONS FOR HVAC

BUS APPLICATIONS FOR HVAC

A.R. LINTERN

Table 18-15: HVAC - A.R. Lintern

OEM Number	Part Number
6215	HA2200
6325	HA2200

AMTRAM

Table 18-16: HVAC - Amtram

OEM Number	Part Number
2503276C1	HB1670
2503278C1	HA1965
2503279C1	HA1970
427484008	HC1185
1691708C91	HA1155
2586986C1	HA1855
2589563C1	HA1850

BLUEBIRD

Table 18-17: HVAC - Bluebird

OEM Number	Part Number
0159723	HA2200
0228080	HA2210
1438480	HA2230
2103414	HA2215
2130656	HA2220
2152270	HA2225
4316238	HA1125

OEM Number	Part Number
8307373	HA2195
6123-0211	RD1020
6123-0211	RD1060
6123-0214	RD1065

IHC

Table 18-18: HVAC - IHC

OEM Number	Part Number
2227279C92	RD1070

KYSOR

Table 18-19: HVAC - Kysor

OEM Number	Part Number
1672003C9	RD1060
6600-0784	RD1020

NAVISTAR

Table 18-20: HVAC - Navistar

OEM Number	Part Number
783966C93	HD1145

SUPERIOR

Table 18-21: HVAC - Superior

OEM Number	Part Number
260534	HA2200
329030	HA2200

OEM Number	Part Number
329094	HA2200

THOMAS BUILT

Table 18-22: HVAC - Thomas Built

OEM Number	Part Number
1118390	HB1625
1476183	HA2190
2602-0369	HD1150
2602-4374	HC1005
2602-6374	HC1485
6500-0439	HA1805
8566-0050	HC1050
8566-0101	HA1980
8566-0102	HB1670
8566-0130	HA1575
8566-0227	HA1965
8566-0233	HC1490
8566-0256	HA1960
8566-0297	HB1680
8566-0378	HA1970
ABP N83 301222	HB1680
ABP N83 301292	HB1670
ABP N83 301322	HB1625
ABP N83 301601	HA1960
ABP N83 301871	HA1805
ABP N83 301881	HA1970
ABP N83 301911	HA1965
n/a	HA2175
n/a	HA2180
n/a	HA2185
n/a	HB1050
RD5-10069-0	HA1805
RD5-10070-0	HA1970
RD5-10072-0	HA1965
RD5-1068-0	HB1625



*For information, updates, or corrections,
please contact us at TRPBus@TRPParts.com*

*No part of this marketing material may be
reproduced in any manner without written
permission from TRP® North America.*

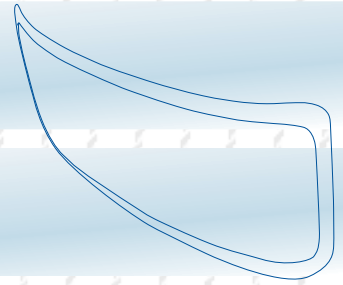
TRP® North America

750 Houser Way N.
Renton, WA 98057

www.trpparts.com



Parts for all brands of buses.



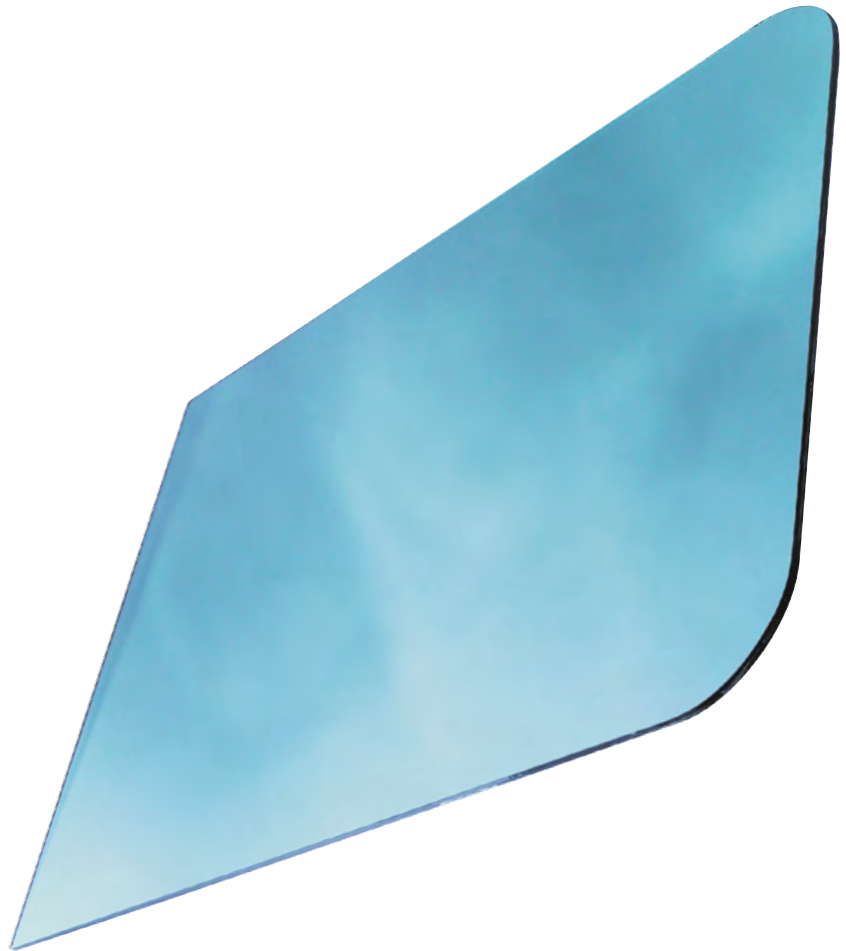
19

BUS PARTS

GLASS

*Proven, reliable and
always innovative.*

TRP® offers reliable aftermarket products that are designed and tested to exceed customers' expectations regardless of the bus make, model or age.



WIPERS • WINDSHIELDS



Tested. Reliable. Guaranteed.

Glass

Choosing the right replacement part or service for your vehicle—whether you own one, or a fleet—is one of the most important decisions you can make for your business. And, with tested TRP® parts it's an easy decision.

Regardless of the make you drive, TRP® quality replacement parts are engineered to fit your truck, trailer or bus. Choose the parts that give you the best value for your business. Check them out at an approved TRP® retailer near you.

The cross reference information in this catalog is based upon data provided by several industry sources and our partners. While every attempt is made to ensure the information presented is accurate, we bear no liability due to incorrect or incomplete information.

Product Availability

Due to export restrictions and market demands, not all products are always available in every location. Check for availability in your area with your local TRP® Distributor.

No part of this marketing material may be reproduced in any manner without written permission from TRP® North America.

CONTENTS

WIPERS

Windshield Wipers	3
Premium Wiper Blades	3
Premium Winter Wiper Blades	3

WINDSHIELDS

AmTran	4
Two-Piece Flat	4
Blue Bird	5
All American	5
Conventional – One-Piece	5
Conventional – Two-Piece Curved	5
TC/2000 – Two-Piece Curved/Green Blue	6
TC/2000 – Two-Piece Curved/Green Tint	6
TC/2000 – Two-Piece Flat	6
Carpenter	7
Two-Piece Flat	7
Navistar	8
Conventional Cab – One-Piece Flat	8
Thomas Built	9
One-Piece Curved	10
Two-Piece Curved/Green Tint	10
Two-Piece Curved/Blue Tint	10
Ward	12
Two-Piece Flat	12
Wayne	13
Two-Piece Flat	13

CROSS REFERENCE

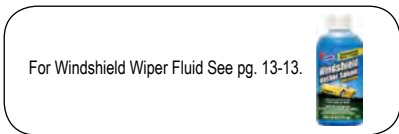
Cross Reference for Glass	14
---------------------------	----

TRP® North America

750 Houser Way N.
Renton, WA 98057

www.trpparts.com

WIPERS



WINDSHIELD WIPERS

- These premium wiper blades, lead the industry in offering our customers high quality products at competitive pricing.
- These blades have been tested by an independent laboratory against competitors' blades, with excellent performance results.
- Superior Rubber Compound & Heavy Duty Construction
- Superior Wipe Quality
- Chatter Resistant, Set, Temperature Extremes, UV, Ozone, Ice & Snow, Chemicals, Corrosions
- Include Common Universal Adapters
- All Steel Construction - Extended Life
- Clean & Quiet Wipe
- Holds Up in Extreme Conditions - More Durable
- Makes for Easy Installation



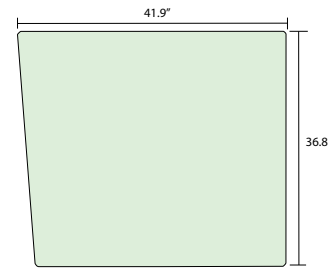
Table 19-1: Wipers - Premium & Winter

Part Number	Description
PREMIUM WIPER BLADES	
WP26031	Premium Wiper Blade, 26", J-Hook
WP26021	Premium Wiper Blade, 26", Saddle Mount
WP28031	Premium Wiper Blade, 28", J-Hook
WP28021	Premium Wiper Blade, 28", Saddle Mount
PREMIUM WINTER WIPER BLADES	
WW26011	Winter Wiper Blade, 26", J-Hook
WW28011	Winter Wiper Blade, 28", J-Hook

WINDSHIELDS

AMTRAN

- Manufactured to OEM specifications to ensure consistent fit and easy installation.
- All-makes coverage means one source for all your windshield requirements.
- Convenient package quantities fit your business requirements.
- Packed in cardboard that is easily recyclable.
- Design meets all DOT standards for safety.



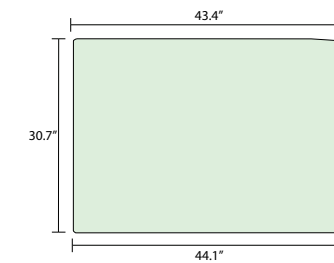
GB482061

Table 19-2: Windshields - AmTran

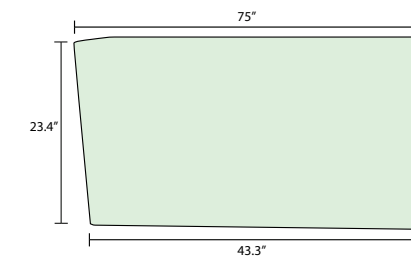
Part Number	Description	OEM Part Number
TWO-PIECE FLAT		
GB482061-5	AmTran Bus - Two-Piece Flat, 41.9" Length x 36.8" Height, Green Tint, AmTran RE GT, 5 Pack	431339001
GB482061-30	AmTran Bus - Two-Piece Flat, 41.9" Length x 36.8" Height, Green Tint, AmTran RE GT, 30 Pack	431339001
GB482060-5	AmTran Bus - Two-Piece Flat, 41.9" Length x 36.7" Height, Green Blue, AmTran RE GB, 5 Pack	431339002
GB482060-30	AmTran Bus - Two-Piece Flat, 41.9" Length x 36.7" Height, Green Blue, AmTran RE GB, 30 Pack	431339002
GB482010-5	AmTran Bus - Two-Piece Flat, 42.4" Top Length x 26.3" Right Height x 40.2" Bottom Length x 26.4" Left Height, Green Blue, Am-Tran GB, 5 Pack	437282002
GB482010-25	AmTran Bus - Two-Piece Flat, 42.4" Top Length x 26.3" Right Height x 40.2" Bottom Length x 26.4" Left Height, Green Blue, Am-Tran GB, 25 Pack	437282002

BLUE BIRD

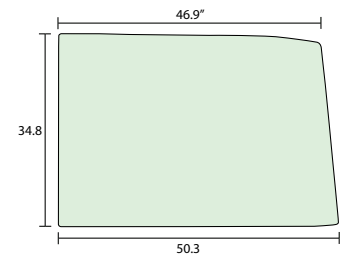
- Manufactured to OEM specifications to ensure consistent fit and easy installation.
- All makes coverage means one source for all your windshield requirements.
- Convenient package quantities fit your business requirements.
- Corrugated cardboard that is easily recyclable.
- Design meets all DOT standards for safety.



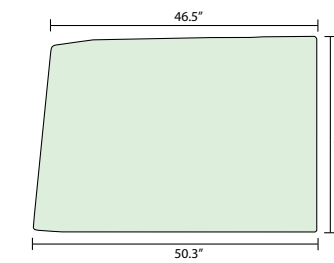
GB482030



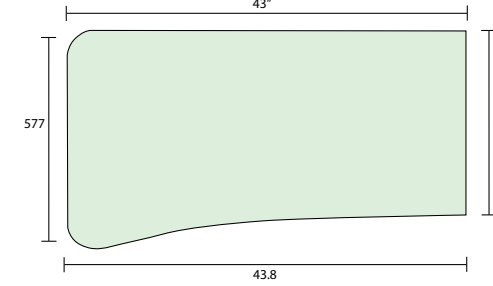
GB48202



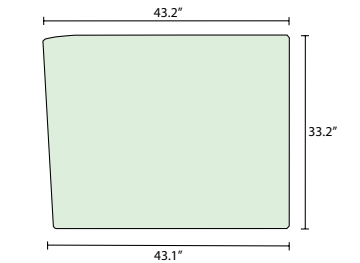
GB482057



GB482055



GB482050



GB482053

Table 19-3: Windshields - Blue Bird

Part Number	Description	OEM Part Number	NAGS Part Number
ALL AMERICAN			
GB482030-5	Bluebird All American - Two-Piece Flat, TC/2000 1987 to 1991, 43.4" Top Length x 30.7" Height x 44.1" Bottom Length, 5 Pack	357335	N/A
GB482030-25	Bluebird All American - Two-Piece Flat, TC/2000 1987 to 1991, 43.4" Top Length x 30.7" Height x 44.1" Bottom Length, 25 Pack	357335	N/A
CONVENTIONAL – ONE-PIECE			
GB48202-5	Bluebird Conventional, 1968 & Later, 75" Top Length x 23.4" Height x 43.3" Bottom Length, 5 Pack	357376	N/A
GB48202-25	Bluebird Conventional, 1968 & Later, 75" Top Length x 23.4" Height x 43.3" Bottom Length, 25 Pack	357375	N/A

Part Number	Description	OEM Part Number	NAGS Part Number
CONVENTIONAL – TWO-PIECE CURVED			
GB482051-5	Bluebird Conventional - Two-Piece Curved, 1962 to Present, 43" Top Length x 23" Left Height x 43.8" Bottom Length x 19.8" Right Height, 5 Pack (RH)	343822	N/A
GB482050-5	Bluebird Conventional - Two-Piece Curved, 1962 to Present, 43" Top Length x 23" Left Height x 43.8" Bottom Length x 19.8" Right Height, 5 Pack (LH)	343830	N/A
GB482051-25	Bluebird Conventional - Two-Piece Curved, 1962 to Present, 43" Top Length x 23" Left Height x 43.8" Bottom Length x 19.8" Right Height, 25 Pack (RH)	343822	N/A
GB482050-25	Bluebird Conventional - Two-Piece Curved, 1962 to Present, 43" Top Length x 23" Left Height x 43.8" Bottom Length x 19.8" Right Height, 25 Pack (LH)	343830	N/A

TC/2000 – TWO-PIECE CURVED/GREEN BLUE

GB482054-5	Bluebird TC/2000 - Two-Piece Curved, 1991 to Present, 46.5" Top Length x 34.7" Height x 50.3" Bottom Length, Green Blue, TC/2000, GB, 5 Pack (LH)	1551217	N/A
GB482054-25	Bluebird TC/2000 - Two-Piece Curved, 1991 to Present, 46.5" Top Length x 34.7" Height x 50.3" Bottom Length, Green Blue, TC/2000, GB, 25 Pack (LH)	1551217	N/A
GB482056-5	Bluebird TC/2000 - Two-Piece Curved, 1991 to Present, 46.9" Top Length x 34.8" Height x 50.3" Bottom Length, Green Blue, TC/2000, GB, 5 Pack (RH)	1551209	N/A
GB482056-25	Bluebird TC/2000 - Two-Piece Curved, 1991 to Present, 46.9" Top Length x 34.8" Height x 50.3" Bottom Length, Green Blue, TC/2000, GB, 25 Pack (RH)	1551209	N/A

TC/2000 – TWO-PIECE CURVED/GREEN TINT

GB482055-5	Bluebird TC/2000 - Two-Piece Curved, 1991 to Present, 46.5" Top Length x 34.7" Height x 50.3" Bottom Length, Green Tint, TC/2000, GT, 5 Pack (LH)	1551191	N/A
GB482055-25	Bluebird TC/2000 - Two-Piece Curved, 1991 to Present, 46.5" Top Length x 34.7" Height x 50.3" Bottom Length, Green Tint, TC/2000, GT, 25 Pack (LH)	1551191	N/A
GB482057-5	Bluebird TC/2000 - Two-Piece Curved, 1991 to Present, 46.9" Top Length x 34.8" Height x 50.3" Bottom Length, Green Tint (RH), TC/2000, GT, 5 Pack (RH)	1551183	N/A
GB482057-25	Bluebird TC/2000 - Two-Piece Curved, 1991 to Present, 46.9" Top Length x 34.8" Height x 50.3" Bottom Length, Green Tint, TC/2000, GT, 25 Pack (RH)	1551183	N/A

TC/2000 – TWO-PIECE FLAT

GB482053-5	Bluebird TC/2000 - Two-Piece Flat, 1991 to Present, 43.2" Top Length x 33.2" Height x 43.1" Bottom Length, Green Tint, TC2000, GT, 5 Pack	1551233	N/A
GB482053-30	Bluebird TC/2000 - Two-Piece Flat, 1991 to Present, 43.2" Top Length x 33.2" Height x 43.1" Bottom Length, Green Tint, TC2000, GT, 30 Pack	1551233	N/A
GB482052-5	Bluebird TC/2000 - Two-Piece Flat, 1991 to Present, 43.2" Top Length x 33.2" Height x 43.1" Bottom Length, Green Blue, TC2000, GB, 5 Pack	1551241	N/A
GB482052-30	Bluebird TC/2000 - Two-Piece Flat, 1991 to Present, 43.2" Top Length x 33.2" Height x 43.1" Bottom Length, Green Blue, TC2000, GB, 30 Pack	1551241	N/A

CARPENTER

- Manufactured to OEM specifications to ensure consistent fit and easy installation.
- All makes coverage means one source for all your windshield requirements.
- Convenient package quantities fit your business requirements.
- Corrugated cardboard that is easily recyclable.
- Design meets all DOT standards for safety.

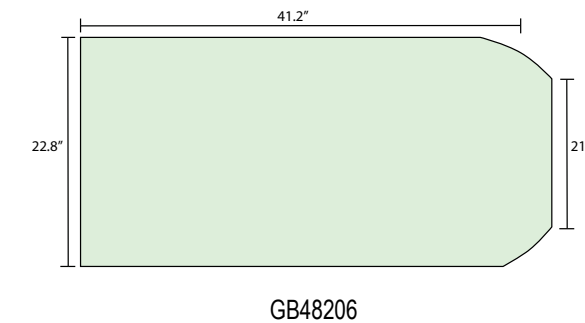


Table 19-4: Windshields - Carpenter

Part Number	Description	OEM Part Number	NAGS Part Number
TWO-PIECE FLAT			
GB48206-5	Carpenter Bus - Two-Piece Flat, 41.2" Length x 21" Height, Special, 5 Pack	N/A	N/A
GB48206-25	Carpenter Bus - Two-Piece Flat, 41.2" Length x 21" Height, Special, 25 Pack	N/A	N/A
GB48203-5	Carpenter Bus - Two-Piece Flat, 41.1" Top Length x 22.6" Right Height x 43.1" Bottom Length x 24.3" Left Height, Green Tint, GT, 5 Pack	N/A	N/A
GB48203-25	Carpenter Bus - Two-Piece Flat, 41.1" Top Length x 22.6" Right Height x 43.1" Bottom Length x 24.3" Left Height, Green Tint, GT, 25 Pack	N/A	N/A

NAVISTAR

- Manufactured to OEM specifications to ensure consistent fit and easy installation.
- All makes coverage means one source for all your windshield requirements.
- Convenient package quantities fit your business requirements.
- Corrugated cardboard that is easily recyclable.
- Design meets all DOT standards for safety.

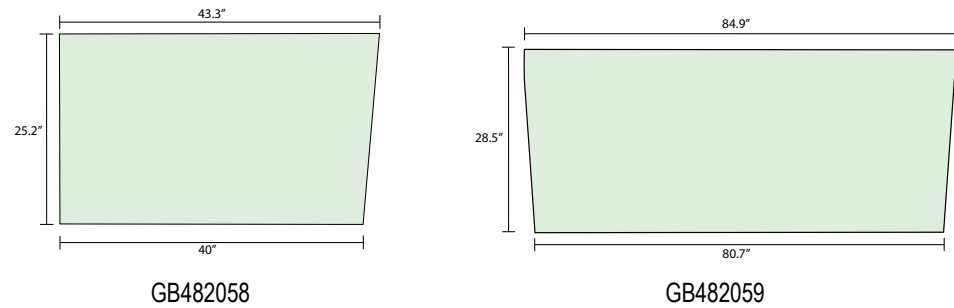


Table 19-5: Windshields - Navistar

Part Number	Description	OEM Part Number	NAGS Part Number
-------------	-------------	-----------------	------------------

CONVENTIONAL CAB – ONE-PIECE FLAT

GB482058-5	Navistar IC 1 - One-Piece Flat, IC- Large, 43.3" Top Length x 25.2" Height x 40" Bottom Length, 5 Pack	446177002	N/A
GB482058-20	Navistar IC 1 - One-Piece Flat, IC- Large, 43.3" Top Length x 25.2" Height x 40" Bottom Length, 20 Pack	226177002	N/A
GB482059-5	Navistar IC 1 - One-Piece Flat, IC- Conventional, 84.9" Top Length x 28.5" Height x 80.7" Bottom Length, 5 Pack	2202541C3	N/A
GB482059-25	Navistar IC 1 - One-Piece Flat, IC- Conventional, 84.9" Top Length x 28.5" Height x 80.7" Bottom Length, 25 Pack	2202541C3	N/A

THOMAS BUILT

- Manufactured to OEM specifications to ensure consistent fit and easy installation.
- All makes coverage means one source for all your windshield requirements.
- Convenient package quantities fit your business requirements.
- Corrugated cardboard that is easily recyclable.
- Design meets all DOT standards for safety.

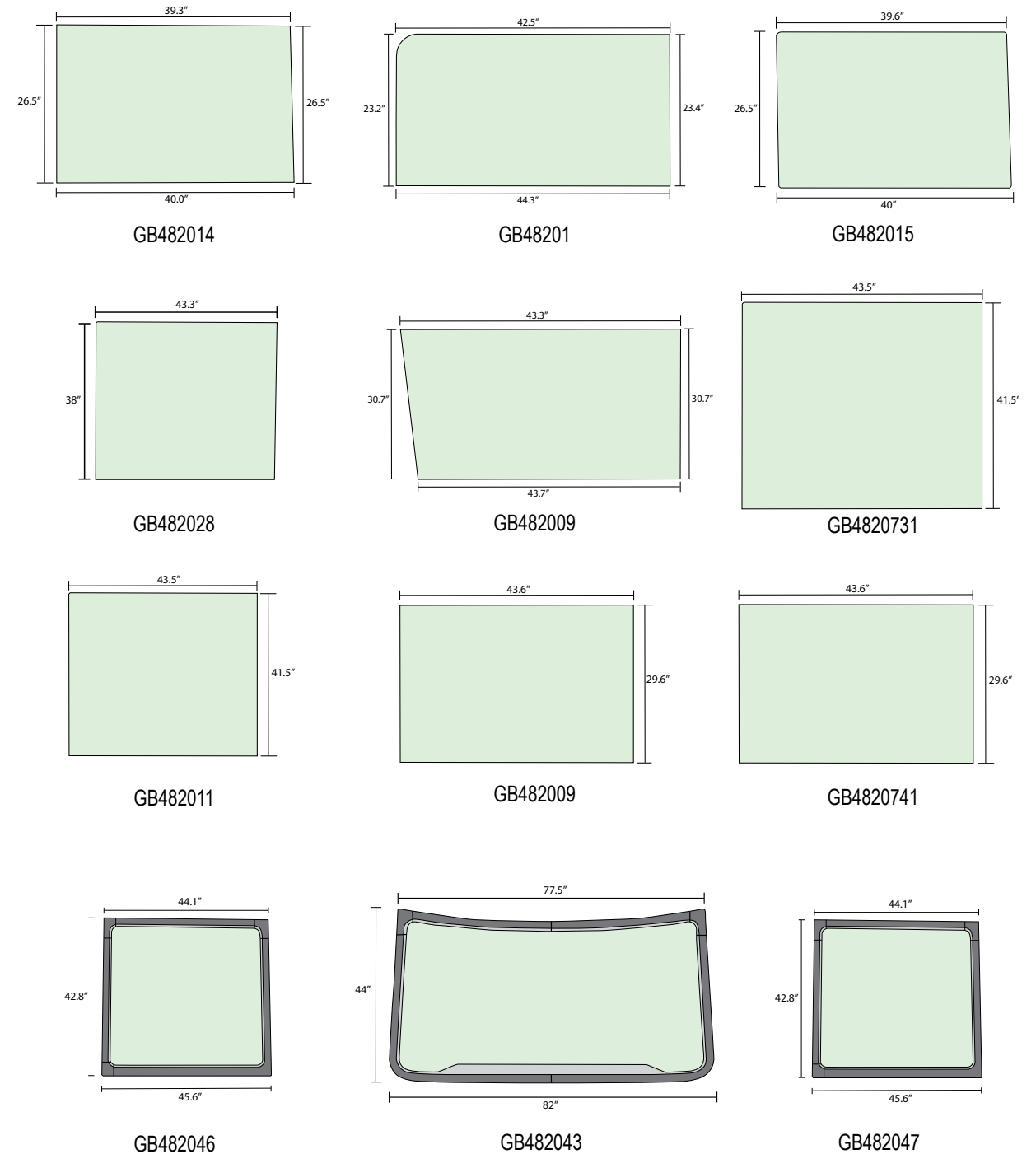


Table 19-6: Windshields - Thomas Built

Part Number	Description	OEM Part Number	NAGS Part Number
ONE-PIECE CURVED			
GB482043-5	Thomas Built C2 Bus - One-Piece Curved, 77.5" Top Length x 44" Height x 82" Bottom Length, Green Tint, C2, GT, 5 Pack	105371	N/A
GB482043-25	Thomas Built C2 Bus - One-Piece Curved, 77.5" Top Length x 44" Height x 82" Bottom Length, Green Tint, C2, GT, 25 Pack	105371	N/A
GB482042-5	Thomas Built C2 Bus - One-Piece Curved, 77.5" Top Length x 44" Height x 82" Bottom Length, Green Blue, C2, GB, 5 Pack	100614	N/A
GB482042-25	Thomas Built C2 Bus - One-Piece Curved, 77.5" Top Length x 44" Height x 82" Bottom Length, Green Blue, C2, GB, 25 Pack	100614	N/A
TWO-PIECE CURVED/GREEN TINT			
GB482047-5	Thomas Built Bus - Two-Piece Curved, 44.1" Top Length x 42.8" Height x 45.6" Bottom Length, Green Tint, Saf-T-Liner, GT, 5 Pack (RH)	53003184	N/A
GB482047-25	Thomas Built Bus - Two-Piece Curved, 44.1" Top Length x 42.8" Height x 45.6" Bottom Length, Green Tint, Saf-T-Liner, GT, 25 Pack (RH)	53003184	N/A
GB482045-5	Thomas Built Bus - Two-Piece Curved, 44.1" Top Length x 42.8" Height x 45.6" Bottom Length, Green Tint, Saf-T-Liner, GT, 5 Pack (LH)	53003183	N/A
GB482045-25	Thomas Built Bus - Two-Piece Curved, 44.1" Top Length x 42.8" Height x 45.6" Bottom Length, Green Tint, Saf-T-Liner, GT, 25 Pack (LH)	53003183	N/A
TWO-PIECE CURVED/BLUE TINT			
GB482046-5	Thomas Built Bus - Two-Piece Curved, 44.1" Top Length x 42.8" Height x 45.6" Bottom Length, Green Blue, Saf-T-Liner, GB, 5 Pack (RH)	53003383	N/A
GB482046-25	Thomas Built Bus - Two-Piece Curved, 44.1" Top Length x 42.8" Height x 45.6" Bottom Length, Green Blue, Saf-T-Liner, GB, 25 Pack (RH)	53003383	N/A
GB482044-5	Thomas Built Bus - Two-Piece Curved, 44.1" Top Length x 42.8" Height x 45.6" Bottom Length, Green Blue, Saf-T-Liner, GB, 5 Pack (LH)	53003382	N/A
GB482044-25	Thomas Built Bus - Two-Piece Curved, 44.1" Top Length x 42.8" Height x 45.6" Bottom Length, Green Blue, Saf-T-Liner, GB, 25 Pack (LH)	53003382	N/A
TWO-PIECE FLAT			
GB482014-5	Thomas Built FS 65 Bus - Two-Piece Flat, 39.3" Top Length x 26.5" Right Height x 40" Bottom Length x 26.5" Left Height, Green Tint, FS 65 GT, 5 Pack	53002859	N/A
GB482014-25	Thomas Built FS 65 Bus - Two-Piece Flat, 39.3" Top Length x 26.5" Right Height x 40" Bottom Length x 26.5" Left Height, Green Tint, FS 65 GT, 25 Pack	53002859	N/A
GB482015-5	Thomas Built FS 65 Bus - Two-Piece Flat, 39.6" Top Length x 26.5" Height x 40" Bottom Length, Green Blue, FS 65 GB, 5 Pack	53002860	N/A
GB482015-25	Thomas Built FS 65 Bus - Two-Piece Flat, 39.6" Top Length x 26.5" Height x 40" Bottom Length, Green Blue, FS 65 GB, 25 Pack	53002860	N/A
GB48201-5	Thomas Built Bus - Two-Piece Flat, 42.5" Top Length x 23.4" Right Height x 44.3" Bottom Length x 23.2" Left Height, Conventional, 5 Pack	13003372	N/A
GB48201-25	Thomas Built Bus - Two-Piece Flat, 42.5" Top Length x 23.4" Right Height x 44.3" Bottom Length x 23.2" Left Height, Conventional, 25 Pack	13003372	N/A
GB482028-5	Thomas Built Bus - Two-Piece Flat, 43.3" Length x 38" Height, Saf-T-Liner & MVP-EF, 5 Pack	53001481	N/A
GB482028-25	Thomas Built Bus - Two-Piece Flat, 43.3" Length x 38" Height, Saf-T-Liner & MVP-EF, 25 Pack	53001481	N/A
GB482009-5	Thomas Built Bus - Two-Piece Flat, 43.3" Top Length x 30.7" Right Height x 43.7" Bottom Length x 30.7" Left Height, Green Tint, MVP & Saf-T-Liner GT, 5 Pack	13005374	N/A
GB482009-25	Thomas Built Bus - Two-Piece Flat, 43.3" Top Length x 30.7" Right Height x 43.7" Bottom Length x 30.7" Left Height, Green Tint, MVP & Saf-T-Liner GT, 25 Pack	13005374	N/A

Part Number	Description	OEM Part Number	NAGS Part Number
GB482011-5	Thomas Built Bus - Two-Piece Flat, 43.5" Length x 41.5" Height, Green Tint, MVP & Saf-T-Liner GT, 5 Pack	53000901	N/A
GB482011-25	Thomas Built Bus - Two-Piece Flat, 43.5" Length x 41.5" Height, Green Tint, MVP & Saf-T-Liner GT, 25 Pack	53000901	N/A
GB4820731-5	Thomas Built Bus - Two-Piece Flat, 43.5" Length x 41.5" Height, Green Blue, MVP & Saf-T-Liner GB, 5 Pack	53000902	N/A
GB4820731-25	Thomas Built Bus - Two-Piece Flat, 43.5" Length x 41.5" Height, Green Blue, MVP & Saf-T-Liner GB, 25 Pack	53000902	N/A
GB482041-5	Thomas Built Vista Bus - Two-Piece Flat, 43.6" Length x 29.6" Height, Green Tint, Vista GT, 5 Pack	53002002	N/A
GB482041-30	Thomas Built Vista Bus - Two-Piece Flat, 43.6" Length x 29.6" Height, Green Tint, Vista GT, 30 Pack	53002002	N/A
GB482040-5	Thomas Built Vista Bus - Two-Piece Flat, 43.6" Length x 29.6" Height, Green Blue, Vista GB, 5 Pack	53002003	N/A
GB482040-30	Thomas Built Vista Bus - Two-Piece Flat, 43.6" Length x 29.6" Height, Green Blue, Vista GB, 30 Pack	53002003	N/A

WARD

- Manufactured to OEM specifications to ensure consistent fit and easy installation.
- All makes coverage means one source for all your windshield requirements.
- Convenient package quantities fit your business requirements.
- Corrugated cardboard that is easily recyclable.
- Design meets all DOT standards for safety.

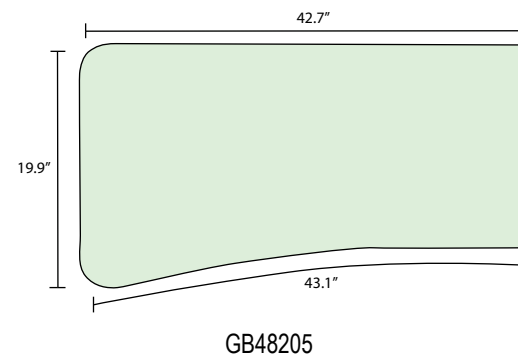


Table 19-7: Windshields - Ward

Part Number	Description	OEM Part Number	NAGS Part Number
TWO-PIECE FLAT			
GB48205-5	Ward Bus - Two-Piece Flat, 42.7" Top Length x 19.9" Height x 43.1" Bottom Length, 5 Pack	413287000	N/A
GB48205-25	Ward Bus - Two-Piece Flat, 42.7" Top Length x 19.9" Height x 43.1" Bottom Length, 25 Pack	413287000	N/A

WAYNE

- Manufactured to OEM specifications to ensure consistent fit and easy installation.
- All makes coverage means one source for all your windshield requirements.
- Convenient package quantities fit your business requirements.
- Corrugated cardboard that is easily recyclable.
- Design meets all DOT standards for safety.

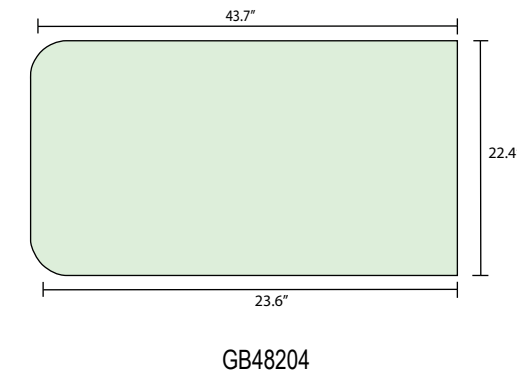


Table 19-8: Windshields - Wayne

Part Number	Description	OEM Part Number	NAGS Part Number
TWO-PIECE FLAT			
GB48204-5	Wayne Bus - Two-Piece Flat, 43.7" Length x 22.4" Left Height x 23.6" Right Height, 5 Pack	659733	N/A
GB48204-25	Wayne Bus - Two-Piece Flat, 43.7" Length x 22.4" Left Height x 23.6" Right Height, 25 Pack	659733	N/A

CROSS REFERENCE

CROSS REFERENCE FOR GLASS

Table 19-9: Cross Reference for Glass

OEM Part Number	TRP Part Number
-----------------	-----------------

ACRAFIT

AMG-TM482009-25	GB482009-25
AMG-TM482009-5	GB482009-5
AMG-AT482010-25	GB482010-25
AMG-AT482010-5	GB482010-5
AMG-TM482011-25	GB482011-25
AMG-TM482011-5	GB482011-5
AMG-TM48201-25	GB48201-25
AMG-TM482014-25	GB482014-25
AMG-TM482014-5	GB482014-5
AMG-TM48201-5	GB48201-5
AMG-TM482015-25	GB482015-25
AMG-TM482015-5	GB482015-5
AMG-BB48202-25	GB48202-25
AMG-BB48202-5	GB48202-5
AMG-TM482028-25	GB482028-25
AMG-TM482028-5	GB482028-5
AMG-BB482030-25	GB482030-25
AMG-BB482030-5	GB482030-5
AMG-CP48203-25	GB48203-25
AMG-CP48203-5	GB48203-5
AMG-TM482040-30	GB482040-30
AMG-TM482040-5	GB482040-5
AMG-TM482041-30	GB482041-30
AMG-TM482041-5	GB482041-5
AMG-TM482042-25	GB482042-25
AMG-WN48204-25	GB48204-25
AMG-TM482042-5	GB482042-5

OEM Part Number	TRP Part Number
AMG-TM482043-25	GB482043-25
AMG-TM482043-5	GB482043-5
AMG-TM482044-25	GB482044-25
AMG-TM482044-5	GB482044-5
AMG-WN48204-5	GB48204-5
AMG-TM482045-25	GB482045-25
AMG-TM482045-5	GB482045-5
AMG-TM482046-25	GB482046-25
AMG-TM482046-5	GB482046-5
AMG-TM482047-25	GB482047-25
AMG-TM482047-5	GB482047-5
AMG-BB482050-25	GB482050-25
AMG-BB482050-5	GB482050-5
AMG-BB482051-25	GB482051-25
AMG-BB482051-5	GB482051-5
AMG-BB482052-30	GB482052-30
AMG-WD48205-25	GB48205-25
AMG-BB482052-5	GB482052-5
AMG-BB482053-30	GB482053-30
AMG-BB482053-5	GB482053-5
AMG-BB482054-25	GB482054-25
AMG-BB482054-5	GB482054-5
AMG-WD48205-5	GB48205-5
AMG-BB482055-25	GB482055-25
AMG-BB482055-5	GB482055-5
AMG-BB482056-25	GB482056-25
AMG-BB482056-5	GB482056-5
AMG-BB482057-25	GB482057-25
AMG-BB482057-5	GB482057-5
AMG-NA482058-20	GB482058-20
AMG-NA482058-5	GB482058-5
AMG-NA482059-25	GB482059-25
AMG-NA482059-5	GB482059-5
AMG-NA482060-30	GB482060-30
AMG-NA482060-5	GB482060-5
AMG-NA482061-30	GB482061-30
AMG-NA482061-5	GB482061-5
AMG-CP48206-25	GB48206-25
AMG-CP48206-5	GB48206-5

OEM Part Number	TRP Part Number
AMG-TM4820731-25	GB4820731-25
AMG-TM4820731-5	GB4820731-5

AMTRAN CORP

437282002	GB482010-25
437282002	GB482010-5

BLUE BIRD CORP

357375	GB48202-25
357375	GB48202-5
357335	GB482030-25
357335	GB482030-5
343830	GB482050-25
343830	GB482050-5
343822	GB482051-25
343822	GB482051-5
1551241	GB482052-30
1551241	GB482052-5
1551233	GB482053-30
1551233	GB482053-5
1551217	GB482054-25
1551217	GB482054-5
1551191	GB482055-25
1551191	GB482055-5
1551209	GB482056-25
1551209	GB482056-5
1551183	GB482057-25
1551183	GB482057-5

NAVISTAR

446177002	GB482058-20
226177002	GB482058-20
226177002	GB482058-5
446177002	GB482058-5
2202541C3	GB482059-25
2202541C3	GB482059-5
431339002	GB482060-30
431339002	GB482060-5
431339001	GB482061-30
431339001	GB482061-5

OEM Part Number	TRP Part Number
-----------------	-----------------

THOMAS BUILT

13005374	GB482009-25
13005374	GB482009-5
53000901	GB482011-25
53000901	GB482011-5
13003372	GB48201-25
53002859	GB482014-25
53002859	GB482014-5
13003372	GB48201-5
53002860	GB482015-25
53002860	GB482015-5
53001481	GB482028-25
53001481	GB482028-5
53002003	GB482040-30
53002003	GB482040-5
53002002	GB482041-30
53002002	GB482041-5
100614	GB482042-25
100614	GB482042-5
105371	GB482043-25
105371	GB482043-5
53003382	GB482044-25
53003382	GB482044-5
53003183	GB482045-25
53003183	GB482045-5
53003383	GB482046-25
53003383	GB482046-5
53003184	GB482047-25
53003184	GB482047-5
53000902	GB4820731-25
53000902	GB4820731-5

WARD TRANSPORTATION

413287000	GB48205-25
413287000	GB48205-5

WAYNE

659733	GB48204-25
659733	GB48204-5



*For information, updates, or corrections,
please contact us at TRPBus@TRPParts.com*

*No part of this marketing material may be
reproduced in any manner without written
permission from TRP® North America.*

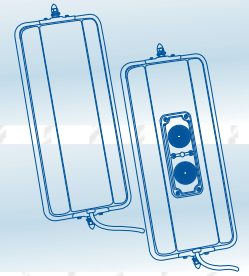
TRP® North America

750 Houser Way N.
Renton, WA 98057

www.trpparts.com



Parts for all brands of buses.



20

BUS PARTS

MIRRORS

*Proven, reliable and
always innovative.*

TRP® offers reliable aftermarket products that are designed and tested to exceed customers' expectations regardless of the bus make, model or age.



BLIND SPOT • CROSS VIEW • DUAL LENS



Tested. Reliable. Guaranteed.

Mirrors

Choosing the right replacement part or service for your vehicle—whether you own one, or a fleet—is one of the most important decisions you can make for your business. And, with tested TRP® parts it's an easy decision.

Regardless of the make you drive, TRP® quality replacement parts are engineered to fit your truck, trailer or bus. Choose the parts that give you the best value for your business. Check them out at an approved TRP® retailer near you.

The cross reference information in this catalog is based upon data provided by several industry sources and our partners. While every attempt is made to ensure the information presented is accurate, we bear no liability due to incorrect or incomplete information.

Product Availability

Due to export restrictions and market demands, not all products are always available in every location. Check for availability in your area with your local TRP® Distributor.

No part of this marketing material may be reproduced in any manner without written permission from TRP® North America.

CONTENTS

MIRRORS

TRP® Mirrors	20-3
Stainless Steel Tripod (SA50) Assembly	20-3
Stainless Steel Tripod (SA50) Replacement Parts	20-3
Stainless Steel Unipod Blind Spot Mirror Assembly	20-3
Rosco Mirrors	20-4
Mini Front Cross View	20-4
Front Cross View	20-4
Eurostyle Dual Lens	20-5
Eurostyle Dual Lens - AccuStyle	20-6

TRP® North America








750 Houser Way N.
Renton, WA 98057

www.trpparts.com

MIRRORS







TRP® MIRRORS






Table 20-1: TRP® Fender & Blind Spot Mirrors

Product	Part Number	Description
STAINLESS STEEL TRIPOD (SA50) ASSEMBLY		
	SA50	Tripod Fender Mount, Conventional Kit, with 8-1/2" Convex Mirror
	SA50F	Tripod Fender Mount, Aero-Style Kit, Shortened with 8-1/2" Convex Mirror
STAINLESS STEEL TRIPOD (SA50) REPLACEMENT PARTS		
	SM3210	Tripod Fender Mount, Center Post Tube, 5/8" x 15"
	SM3211	Tripod Fender Mount, Gooseneck Tube, 3/4"
	SM3212	Tripod Fender Bell Mount, Non-Adjustable Leg
STAINLESS STEEL UNIPOD BLIND SPOT MIRROR ASSEMBLY		
	SA917S	Unipod Blind Spot Mirror Kit, Hood Mount, with 8-1/2" Convex Mirror, Straight & Curved Arms Included
	SA52	Unipod Blind Spot Mirror Kit, Hood Mount, with 8-1/2" Fish-eye Mirror, Straight & Curved Arm Included

ROSCO MIRRORS

Table 20-2: Rosco School Bus Mirrors

Product	Part Number	Description
MINI FRONT CROSS VIEW		
	33651H	Rosco Mini Hawk Eye™ 12-1/2" x 10" Front Cross View Mirror Head only, with Ball Stud Mount System, heated mirror surfaces, Internal Harness Connector
	3365H	Rosco Mini Hawk Eye™ 12-1/2" x 10" Front Cross View Mirror Head only, with Ball Stud Mount System, heated mirror surfaces, Internal Harness Connector
	3365RSC	Rosco Mini Hawk Eye™ 12-1/2" x 10" Front Cross View Mirror Head only, with Ball Stud Mount System
FRONT CROSS VIEW		
	23651H	Rosco Hawk Eye™ 12-1/2" x 11" Front Cross View Mirror Head only, with Ball Stud Mount System, heated mirror surfaces, Internal Harness
	2365H	Rosco Hawk Eye™ 12-1/2" x 11" Front Cross View Mirror Head only, with Ball Stud Mount System, Heated Mirror Surfaces
	2365RSC	Rosco Hawk Eye™ 12-1/2" x 11" Front Cross View Mirror Head only, with Ball Stud Mount System

Product	Part Number	Description
EUROSTYLE DUAL LENS		
	7150GH	Rosco EuroStyle 8" x 15" Dual Lens Mirror, overhang mount with 12 volt, motorized, heated mirror surfaces
	715H	Rosco EuroStyle 8" x 15" Dual Lens Mirror, upright mount with 12 volt, motorized, heated mirror surfaces
	7170GH	Rosco EuroStyle 8" x 17" Dual Lens Mirror, overhang mount with 12 volt motorized, heated mirror surfaces
	71710G	Rosco EuroStyle 8" x 17" Dual Lens Mirror, overhang mount with 12 volt motorized mirror surfaces; Wired for International
	71710GH	Rosco EuroStyle 8" x 17" Dual Lens Mirror, overhang mount with 12 volt motorized, heated mirror surfaces; Wired for International
	M7150G	Rosco EuroStyle 8" x 15" Dual Lens Mirror, overhang mount, hand adjustable mirror surfaces



*For information, updates, or corrections,
please contact us at TRPBus@TRPParts.com*

*No part of this marketing material may be
reproduced in any manner without written
permission from TRP® North America.*

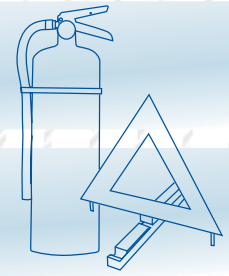
TRP® North America

750 Houser Way N.
Renton, WA 98057

www.trpparts.com



Parts for all brands of buses.



21

BUS PARTS

SAFETY

Proven, reliable and always innovative.

TRP® offers reliable aftermarket products that are designed and tested to exceed customers' expectations regardless of the bus make, model or age.



CONSPICUITY TAPE • FIRE EXTINGUISHER • FIRST AID • TIRE SYSTEMS



Tested. Reliable. Guaranteed.

Safety

Choosing the right replacement part or service for your vehicle—whether you own one, or a fleet—is one of the most important decisions you can make for your business. And, with tested TRP® parts it's an easy decision.

Regardless of the make you drive, TRP® quality replacement parts are engineered to fit your truck, trailer or bus. Choose the parts that give you the best value for your business. Check them out at an approved TRP® retailer near you.

The cross reference information in this catalog is based upon data provided by several industry sources and our partners. While every attempt is made to ensure the information presented is accurate, we bear no liability due to incorrect or incomplete information.

Product Availability

Due to export restrictions and market demands, not all products are always available in every location. Check for availability in your area with your local TRP® Distributor.

No part of this marketing material may be reproduced in any manner without written permission from TRP® North America.

CONTENTS

CONSPICUITY TAPE

[School Bus Signs](#) 21-4
[Conspicuity Tape for School Buses](#) 21-4

FIRST AID KITS

[First Aid Kits](#) 21-6
 Small All-Purpose First Aid Kit 21-6
[First Aid Kits](#) 21-7
 Large All-Purpose First Aid Kit 21-7
 Automotive First Aid Kit 21-8
[First Aid Kits](#) 21-9
 10-Person First Aid Kit 21-9
[First Aid Kits](#) 21-10
 25-Person First Aid Kit 21-10

FIRE EXTINGUISHER RATINGS

[Fire Extinguisher Ratings](#) 21-11

FIRE EXTINGUISHERS

[Fire Extinguishers](#) 21-13

TRP® North America

750 Houser Way N.
 Renton, WA 98057

www.trpparts.com

TRP® TRIANGLE KITS

[Triangle Kits](#) 21-14

MISCELLANEOUS

[Permit Holders](#) 21-14

TIRE CHAINS

[Tire Chains – Onspot of North America Inc.](#) 21-15
 Onspot Chain System 21-15
 Service Parts for Onspot 21-15

TIRE PRESSURE MAINTENANCE SYSTEM

[Pressure Pro Tire Pressure Maintenance System](#) 21-16
[Bendix CVS - SmarTire™ Tire Pressure Monitoring System](#) 21-16
[Bendix CVS - SmarTire™ Retrofit Kit](#) 21-16
[Bendix CVS - SmarTire™ Tools and Diagnostic Aids](#) 21-16
[Service Parts for SmarTire™ by Bendix CVS](#) 21-16
[Cat's Eye \(Link\) Tire Pressure Monitoring System](#) 21-17
 Cat's Eye: 2-unit Bubble Pack - Rubber Hoses, Dual Tires 21-17
 Cat's Eye: 2-unit Bubble Pack - Rubber Hoses, Super Single 21-17
 Cat's Eye: 2-unit Bubble Pack - Stainless Steel Hoses, Dual Tires 21-17
 Cat's Eye: 2-unit Bubble Pack - Stainless Steel Hoses, Super Single 21-18
 Cat's Eye: 4-unit Box - Rubber Hoses, Dual Tires 21-18
 Cat's Eye: 4-unit Box - Rubber Hoses, Super Single 21-18
 Cat's Eye: 4-unit Box - Stainless Steel, Dual Tires 21-18
 Cat's Eye: 4-unit Box - Stainless Steel, Super Single 21-19
 Service Parts for Cat's Eye 21-19

CONSPICUITY TAPE

2 KINDS OF MICRO-PRISMATIC RETRO-REFLECTIVE TAPE OFFERED:

- Traditional conspicuity tape with Poly-Carbonate prism layer for high visibility during daylight hours and traditional coloration. (White Base Layer, thicker, more rigid)
- New, thin and impact resistant tape with Polyester prism layer for durable, longer-lasting product. (Metallic Silver Base Layer, more malleable)
- Both tapes offer similar reflective qualities in low light.




SCHOOL BUS SIGNS

Table 21-1: School Bus Signs

Part Number	Description	Fits Best
E98-4441-S01EA	"School Bus" Signs fits Front or Rear, School Bus Yellow & Black 8-3/4" x 36" Each	Blue Bird
E88-4441-0005EA	"School Bus" Signs fits Front or Rear, School Bus Yellow & Black, 9-1/5" x 36"	IC Corp
E98-4436-S01EA	"School Bus" Sign fits Front or Rear, School Bus Yellow & Black, 8-3/4" x 36", Each	Thomas / Daimler
E88-4441EA	"School Bus" Sign fits Front or Rear, School Bus Yellow & Black, 9-1/4" x 42", Each	Thomas / Daimler
E99-4441EA	"School Bus" Sign fits Front or Rear, School Bus Yellow & Black, 9-1/4" x 42", Each	Thomas / Daimler
E99-4441-471EA	"School Bus" Sign fits Front or Rear, School Bus Yellow & Black, 10-3/4" x 46-3/4", Each	Thomas / Daimler
E99-4441-124EA	"School Bus" Sign fits Front or Rear, School Bus Yellow & Black, 12" x 42-1/2", Each	Thomas / Daimler
E99-4441-401EA	"School Bus" Sign fits Front or Rear, School Bus Yellow & Black, 12-1/2" x 38", Each	Thomas / Daimler
E88-4441-005EA	"School Bus" Sign fits Front or Rear, School Bus Yellow & Black, 9-1/4" x 36", Each	Navistar
31120MMM	"School Bus" Sign fits Front or Rear, School Bus Yellow & Black, Diamond Grade, " 44" x 10" Each	Not available
E99-4441-965EA	"Emergency Exit" Sign fits Rear, School Bus Yellow & Black 2-3/4" x 16-1/2" Each	Thomas / Daimler

CONSPICUITY TAPE FOR SCHOOL BUSES

Table 21-2: School Bus Conspicuity Tape

Product	Part Number	Description
	V92-4441-010150	5 Year School Bus Yellow, 1" x 150' Roll
	V82-4441-010150	10 Year School Bus Yellow, 1" x 150' Roll

Product	Part Number	Description
	V92-4441-020150	5 Year School Bus Yellow, 2" x 150' Roll
	V82-4441-020150	10 Year School Bus Yellow, 2" x 150' Roll
	V82-1541-010150	10 Year White, 1" x 150' Roll
	V99-4441-020150	10 Year School Bus Yellow, 2" x 150' Roll
	67885MMM	School Bus Yellow, 2" x 150' Roll
	30887MMM	Diamond Grade, School Bus Yellow, 1" x 150' Roll
	30926MMM	Diamond Grade, School Bus Yellow, 1-3/4" x 150' Roll
	30925MMM	Diamond Grade, School Bus Yellow, 2" x 150' Roll
	30866MMM	Diamond Grade, School Bus Yellow, 3" x 150' Roll

FIRST AID KITS

FIRST AID KITS

Be ready for all potential emergencies at home, in the car, outdoors or on the water. Our new generation of hard kit is developed to save time and frustration in the midst of emergency situations. Supplies are easy to find in our newly designed organizer case.

Kit Dimensions: 6-3/8"x4-1/2"x1-7/8"



Kit Includes:

- (10) 3/4"x3" Adhesive plastic bandages
- (1) Knuckle fabric bandage
- (1) Fingertip fabric bandage
- (1) 2"x4" Elbow & knee plastic bandage
- (10) 3/8"x1-1/2" Junior plastic bandages
- (2) Butterfly wound closures
- (2) Aspirin tablets
- (2) Ibuprofen tablets
- (4) Extra-strength non-aspirin tablets
- (6) Alcohol cleansing pads
- (6) Antiseptic cleansing wipes (sting free)
- (2) Antibiotic ointment packs
- (1) Medium #2 safety pin
- (2) Exam quality vinyl gloves
- (1) First aid guide

Table 21-3: First Aid Kit - Small All-Purpose

Part Number	Description
SMALL ALL-PURPOSE FIRST AID KIT	
FA0-122PAC	52-piece Small All-Purpose First Aid Kit

FIRST AID KITS



Kit Includes:

- (50) 3/4"x3" Adhesive plastic bandages
- (10) 3/4"x3" Fabric bandages
- (20) 1"x3" Fabric bandages
- (8) Knuckle fabric bandages
- (8) Fingertip fabric bandages
- (1) 2"x4" Elbow & knee plastic bandage
- (20) 3/8"x1-1/2" Junior plastic bandages
- (5) Butterfly wound closures
- (12) 7/8" Spot plastic bandages
- (10) 2"x2" Gauze dressing pads
- (2) 3"x3" Gauze dressing pads
- (1) 5"x9" Trauma pad
- (2) Aspirin tablets
- (2) Ibuprofen tablets
- (4) Extra-strength non-aspirin tablets
- (8) Alcohol cleansing pads
- (12) BZK antiseptic towelettes
- (4) Antibiotic ointment packs
- (1) 1/2"x5 yd. First aid tape roll
- (1) 4"x5" Instant cold compress
- (1) Burn relief pack, 3.5 gm.
- (1) Sterile eye pad
- (1) Emergency blanket
- (10) 3" Cotton tipped applicators
- (1) 6"x11/16" Finger splint
- (2) Exam quality vinyl gloves
- (1) 4" Tweezers, plastic
- (1) First aid guide

Table 21-4: First Aid Kit - Large All-Purpose

Part Number	Description
LARGE ALL-PURPOSE FIRST AID KIT	
FA0-134PAC	200-piece Large All-Purpose First Aid Kit

FIRST AID KITS

This small auto first aid kit allows you to be prepared for all potential first aid emergencies on the road. It contains medications, antiseptics, bandages, and wound care items. The size makes it ideal for the glove compartment or console storage.



Kit includes:

- (2) Extra-strength non-aspirin tablets
- (2) Aspirin tablets
- (2) Motion sickness tablets
- (1) Insect sting relief pad
- (2) Antibiotic ointment packs
- (6) Alcohol cleansing pads
- (3) Antiseptic cleansing wipes (sting free)
- (10) 3/4" x 3" Adhesive plastic bandage
- (1) 2" x 4" Elbow & knee plastic bandage
- (1) Fingertip fabric bandage
- (1) Knuckle fabric bandage
- (1) 2" x 3" Non-stick pad with adhesive tabs
- (4) 2" x 2" Gauze dressing pads
- (1) 1/2" x 5 yd First aid tape roll
- (2) Exam quality vinyl gloves
- (1) First aid guide

Table 21-5: First Aid Kit - Automotive

Part Number	Description
AUTOMOTIVE FIRST AID KIT	
FA0-320PAC	41-piece Automotive First Aid Kit

FIRST AID KITS

This 63-piece first aid kit is ideal for contractors, vehicles or small companies with less than 10 employees. It meets federal OSHA requirements 1910.151b (State requirements may vary). Sturdy and convenient, the 10-unit plastic case contains the first aid essentials to prepare each vehicle for work-related accidents. The partitioned, water-resistant plastic case is wall mountable yet has a handle for easy carrying.

Kit Dimensions: 9"x8-3/8"x2-1/2"



Kit Includes:

- (16) 3/4"x3" Adhesive plastic bandages
- (1) 2"x4" Elbow & knee plastic bandage
- (1) fingertip fabric bandage
- (4) 2"x2" Gauze dressing pads
- (4) 3"x3" Gauze dressing pads
- (2) 4"x4" Gauze dressing pads
- (1) 5"x9" Trauma pad
- (1) 2" Conforming gauze roll bandage
- (1) 3" Conforming gauze roll bandage
- (1) 36" Triangular sling/bandage, w/2 safety pins
- (6) Aspirin tablets, (3) 2-pks
- (6) Alcohol cleansing pads
- (6) BZK antiseptic towelettes
- (1) 2" Conforming gauze roll bandage
- (1) 1"x5 yd. First aid tape roll
- (1) 6"x9" Instant cold compress
- (1) Sterile eye pad
- (2) Exam quality vinyl gloves, 1 pair
- (1) 4-1/2" Scissors, nickel plated
- (1) 4" Tweezers, plastic
- (1) First aid guide
- (3) Triple antibiotic ointment packs

Table 21-6: First Aid Kit - 10-Person

Part Number	Description
10-PERSON FIRST AID KIT	
222UPAC	10-person OSHA First Aid Kit

FIRST AID KITS

This 107-piece first aid kit is ideal for contractors, fleet vehicles, worksites or small companies with up to 25 employees. It meets federal OSHA recommendations and carries 17 critical products including a 4 oz. eye wash. The partitioned, water-resistant plastic case is wall mountable yet has a handle for easy carrying.

Kit Dimensions: 9"x8-3/8"x2-1/2"



Kit Includes:

- (50) Adhesive plastic bandages, 3/4" x 3"
- (3) Large fingertip fabric bandages
- (2) Knuckle fabric bandages
- (1) Triangular sling/bandage, w/2 safety pins, 36"
- (6) Gauze dressing pads, 2" x 2"
- (1) Conforming gauze roll bandage, 2"
- (1) Trauma pad, 5" x 9"
- (1) Sterile eye pad
- (12) BZK antiseptic towelettes
- (6) Triple antibiotic ointment packs
- (3) Insect sting relief pads
- (1) Eye wash, 4 oz.
- (1) Instant cold compress, 4" x 5"
- (12) Aspirin tablets, (6) 2-pks
- (1) First aid tape roll, 1/2" x 5 yd.
- (1) Scissors, 4-1/2", nickel plated
- (1) Tweezers, 4", plastic
- (2) Exam quality vinyl gloves, 1 pair
- (1) First aid guide

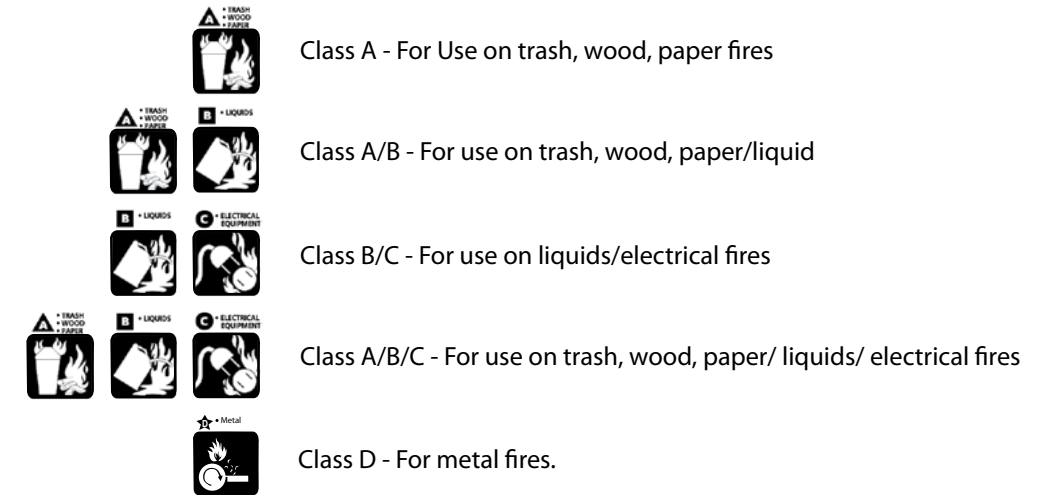
Table 21-7: First Aid Kit - 25-Person

Part Number	Description
25-PERSON FIRST AID KIT	
223UPAC	25 Person Plastic Case OSHA First Aid Kit

FIRE EXTINGUISHER RATINGS

SPECIFIC TYPED SYMBOLS

Fire extinguishers are classified to indicate their ability to handle specific classes and sizes of fires. There are four types of extinguishers:



LETTER-SHAPED SYMBOLS

These are also used to indicate extinguisher suitability according to class of fire.

Class A
ORDINARY
A
COMBUSTIBLES
An extinguisher for Class A fires could have any one of the following ratings: 1-A, 2-A, 3-A, 4-A, 6-A, 10-A, 20-A, 30-A, and 40-A. A 4-A extinguisher, for example, should extinguish about twice as much fire as a 2-A extinguisher.

Class B
FLAMMABLE
B
LIQUIDS
An extinguisher for Class B fires could have any one of the following ratings: 1-B, 2-B, 5-B, 10-B, 20-B, 30-B, 40-B, and up to 640-B.

Class C
ELECTRICAL
C
EQUIPMENT
Extinguishers rated for Class C fires are tested only for electrical conductivity. However, no extinguisher gets a Class C rating without a Class A and/or Class B rating.

Class D
COMBUSTIBLE
D
METALS
Class D extinguishers are tested on metal fires. The agent used depends on the metal for which the extinguisher was designed. Check the extinguisher faceplate for the unit's effectiveness on specific metals.

FIRE EXTINGUISHER RATINGS

Extinguishers are rated according to the extinguishing ability of each unit. As a result of testing by Underwriters' Laboratories, Inc., all extinguishers have a classification on them that consist of a number and a letter. The number indicates the approximate capacity of the extinguisher when applied to an estimated size of fire and the letter identifies a class of fire.

Fire suppression capacity is related to experience of the operator. Class B: the numeric rating also indicates the fire suppression capacity of the extinguisher when used. Anyone should be able to put out a fire encompassing 10 sq ft (.9 m2) with a 10-B:C extinguisher and a 20 sq ft (1.8 m2) fire with a 20-B:C extinguisher. An experienced operator could put out a fire covering 25 sq ft (2.3 m2) with a 10-B:C extinguisher and 50 sq. ft. (4.6 m2) with a 20-B:C extinguisher. Class C: only the symbol is present and no numerical rating because these fires are basically more complex Class A or Class B fires.

DOT requirements:

Each State DOT has its own special rules regarding fire extinguishers requirements for commercial motor vehicle. Operators should check their states DOT for specifics. United States Department of Transportation's Basic Guidelines:

Fire extinguishers must be securely mounted and readily accessible for use. Each extinguisher must have a gauge or other indicator that shows whether the extinguisher is fully charged, and a label showing its Underwriters' Laboratories (UL) rating.

EMERGENCY EQUIPMENT

Commercial motor vehicles must carry the following emergency equipment:

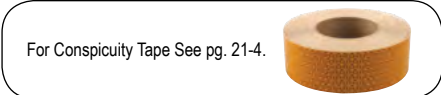
- Fire extinguisher
- Warning devices for stopped vehicles

Fire extinguishers must be securely mounted and readily accessible for use. Each extinguisher must have a gauge or other indicator that shows whether the extinguisher is fully charged, and a label showing its Underwriters' Laboratories (UL) rating.

Fire extinguisher(s) must meet one of the following standards:

- One extinguisher with a UL rating of 5 B:C or more
- Or two extinguishers each with a UL rating of 4 B:C or more

FIRE EXTINGUISHERS



FIRE EXTINGUISHERS

Table 21-8: Fire Extinguishers

Part Number	Description
466141-01	Fire Extinguisher (Red) - UL Listed 10B:C - 2-1/2 lb. Extinguisher (Qty: 6 per box)
440161	Fire Extinguisher (Red) - UL Listed 10B:C - 2-1/2 lb. Extinguisher w/ Zytel Valve & Nylon Strap (Qty: 6 per box)
468129-006	Fire Extinguisher (Special Finish - Silver) - UL Listed 5B:C - 2 lb (Qty: 6 per box)
468155-006	Fire Extinguisher (Special Finish - Blue) - UL Listed 5B:C - 2 lb (Qty: 6 per box)
468154-006	Fire Extinguisher (Special Finish - Burgandy) - UL Listed 5B:C - 2 lb (Qty: 6 per box)

Fire Extinguishers for buses are highly regulated and are state-specific. Please check with your local regulations before ordering or installing a fire extinguisher.

TRIANGLE KITS



TRP® WARNING TRIANGLE KITS

Table 21-9: Emergency & Safety Kits

Part Number	Description
MD1005K	TRP® Warning Triangle Kit
1005B1	Triangle Kit Bracket

MISCELLANEOUS




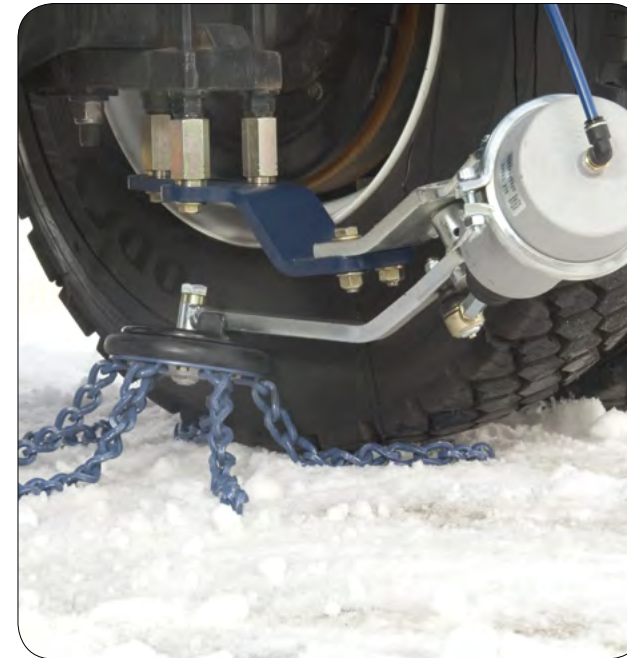
PERMIT HOLDERS

Table 21-10: Permit Holders

Part Number	Description
00909-0000B	Permit Pouch, OE, Clear front, Green Vinyl, Self- Sealing Zipper; 6" x 9"

TIRE CHAINS

For Air Springs See pg. 6-5. 



TIRE CHAINS – ONSPOT OF NORTH AMERICA INC.

Table 21-11: Tire Chains - Onspot of North America Inc.

Part Number	Description
-------------	-------------

ONSPOT CHAIN SYSTEM

P0AC10000	Primary new kit fit for all makes/ models: Use Part# P0AC10000 for any school bus with air brakes and spring or air suspension. If no air source, Add PN P0AC9603 to your order.
-----------	--

SERVICE PARTS FOR ONSPOT

P0AC1037B	Complete Cylinder, 235mm with Extender
P0AC5047B	Electric Valve for PN#s 5979603, 5047
P0AC9603	ONSPOT Stainless Steel Cable Tie or Kit, 12 Volt Air Kit (9612 compressor)
P0AC9054	Air Compressor Protective Housing (9612 compressor)

Automatic Tire Chain System by ONSPOT. Grips with the touch of a button. No downtime!

TIRE PRESSURE MAINTENANCE SYSTEM



PRESSURE PRO TIRE PRESSURE MAINTENANCE SYSTEM

Table 21-12: Pressure Pro Tire Pressure Monitoring System

Part Number	Description
PP803978	Pressure Pro tire pressure monitoring system, 6-wheel
PP803980	Pressure Pro tire pressure monitoring system, 10-wheel
PP804146	Pressure Pro tire pressure monitoring system, 6-wheel, data-logging
PP804148	Pressure Pro tire pressure monitoring system, 10-wheel, data-logging



BENDIX CVS SMARTIRE™ TIRE PRESSURE MONITORING SYSTEM

Table 21-13: Bendix CVS SmarTire™ Tire Pressure Monitoring System

Part Number	Description
-------------	-------------

BENDIX CVS - SMARTIRE™ RETROFIT KIT

108.1204	SmarTire™ TPMS 4 wheel kit
----------	----------------------------

BENDIX CVS - SMARTIRE™ TOOLS AND DIAGNOSTIC AIDS

090.0011	SmarTire™ Maintenance Tool
090.0021	SmarTire™ Low Frequency Tool
108.9003	SmarTire™ Diagnostic Cable

SERVICE PARTS FOR SMARTIRE™ BY BENDIX CVS

201.0007N	SmarTire™ Sensor/Transmitter with Cradle
264.0115N	SmarTire™ Strap-Stainless Steel Clamp
264.0228N	SmarTire™ Sensor/ Transmitter Cradle
108.9002N	SmarTire™ Warning Light Kit

CAT'S EYE (LINK) TIRE PRESSURE MONITORING SYSTEM



2 Unit Retail Bubble Pack:
2 Cat's Eye® units with reinforced rubber/stainless steel hoses, mounting brackets, "How To Read Cat's Eye" decal, installation instructions & warranty card.

Table 21-14: Cat's Eye 2-Unit Retail Bubble Pack

Part Number	Description
-------------	-------------

CAT'S EYE: 2-UNIT BUBBLE PACK - RUBBER HOSES, DUAL TIRES

6080AA00	Cat's Eye - 80 PSI - 2 Pack - 16" Rubber Hoses - Dual Tires
6085AA00	Cat's Eye - 85 PSI - 2 Pack - 16" Rubber Hoses - Dual Tires
6090AA00	Cat's Eye - 90 PSI - 2 Pack - 16" Rubber Hoses - Dual Tires
6095AA00	Cat's Eye - 95 PSI - 2 Pack - 16" Rubber Hoses - Dual Tires
6100AA00	Cat's Eye - 100 PSI - 2 Pack - 16" Rubber Hoses - Dual Tires
6105AA00	Cat's Eye - 105 PSI - 2 Pack - 16" Rubber Hoses - Dual Tires
6110AA00	Cat's Eye - 110 PSI - 2 Pack - 16" Rubber Hoses - Dual Tires
6115AA00	Cat's Eye - 115 PSI - 2 Pack - 16" Rubber Hoses - Dual Tires

CAT'S EYE: 2-UNIT BUBBLE PACK - RUBBER HOSES, SUPER SINGLE

6080AC00	Cat's Eye - 80 PSI - 2 Pack - 12" Rubber Hoses - Super Single
6085AC00	Cat's Eye - 85 PSI - 2 Pack - 12" Rubber Hoses - Super Single
6090AC00	Cat's Eye - 90 PSI - 2 Pack - 12" Rubber Hoses - Super Single
6095AC00	Cat's Eye - 95 PSI - 2 Pack - 12" Rubber Hoses - Super Single
6100AC00	Cat's Eye - 100 PSI - 2 Pack - 12" Rubber Hoses - Super Single
6105AC00	Cat's Eye - 105 PSI - 2 Pack - 12" Rubber Hoses - Super Single
6110AC00	Cat's Eye - 110 PSI - 2 Pack - 12" Rubber Hoses - Super Single
6115AC00	Cat's Eye - 115 PSI - 2 Pack - 12" Rubber Hoses - Super Single

CAT'S EYE: 2-UNIT BUBBLE PACK - STAINLESS STEEL HOSES, DUAL TIRES

6090AB00	Cat's Eye - 90 PSI - 2 Pack - 16" Stainless Steel - Dual Tires
6095AB00	Cat's Eye - 95 PSI - 2 Pack - 16" Stainless Steel - Dual Tires
6100AB00	Cat's Eye - 100 PSI - 2 Pack - 16" Stainless Steel - Dual Tires
6105AB00	Cat's Eye - 105 PSI - 2 Pack - 16" Stainless Steel - Dual Tires
6110AB00	Cat's Eye - 110 PSI - 2 Pack - 16" Stainless Steel - Dual Tires
6110AJ00	Cat's Eye - 110 PSI - 2 Pack - 12" Stainless Steel - Super Single
6115AB00	Cat's Eye - 115 PSI - 2 Pack - 16" Stainless Steel - Dual Tires
6115AJ00	Cat's Eye - 115 PSI - 2 Pack - 12" Stainless Steel - Super Single

Part Number	Description
-------------	-------------

CAT'S EYE: 2-UNIT BUBBLE PACK - STAINLESS STEEL HOSES, SUPER SINGLE

6080AJ00	Cat's Eye - 80 PSI - 2 Pack - 12" Stainless Steel - Super Single
6085AJ00	Cat's Eye - 85 PSI - 2 Pack - 12" Stainless Steel - Super Single
6090AJ00	Cat's Eye - 90 PSI - 2 Pack - 12" Stainless Steel - Super Single
6095AJ00	Cat's Eye - 95 PSI - 2 Pack - 12" Stainless Steel - Super Single
6100AJ00	Cat's Eye - 100 PSI - 2 Pack - 12" Stainless Steel - Super Single
6105AJ00	Cat's Eye - 105 PSI - 2 Pack - 12" Stainless Steel - Super Single
6110AJ00	Cat's Eye - 110 PSI - 2 Pack - 12" Stainless Steel - Super Single

4 Unit Box:

4 Cat's Eye® units with reinforced rubber/stainless steel hoses, mounting brackets, "How To Read Cat's Eye" decal, installation instructions & warranty card.



Table 21-15: Cat's Eye 4-Unit Box

Part Number	Description
-------------	-------------

CAT'S EYE: 4-UNIT BOX - RUBBER HOSES, DUAL TIRES

6080BA00	Cat's Eye - 80 PSI - 4 Pack - 16" Rubber Hoses - Dual Tires
6085BA00	Cat's Eye - 85 PSI - 4 Pack - 16" Rubber Hoses - Dual Tires
6090BA00	Cat's Eye - 90 PSI - 4 Pack - 16" Rubber Hoses - Dual Tires
6095BA00	Cat's Eye - 95 PSI - 4 Pack - 16" Rubber Hoses - Dual Tires
6100BA00	Cat's Eye - 100 PSI - 4 Pack - 16" Rubber Hoses - Dual Tires
6105BA00	Cat's Eye - 105 PSI - 4 Pack - 16" Rubber Hoses - Dual Tires
6110BA00	Cat's Eye - 110 PSI - 4 Pack - 16" Rubber Hoses - Dual Tires
6115BA00	Cat's Eye - 115 PSI - 4 Pack - 16" Rubber Hoses - Dual Tires

CAT'S EYE: 4-UNIT BOX - RUBBER HOSES, SUPER SINGLE

6080BC00	Cat's Eye - 80 PSI - 4 Pack - 12" Rubber Hoses - Super Single
6085BC00	Cat's Eye - 85 PSI - 4 Pack - 12" Rubber Hoses - Super Single
6090BC00	Cat's Eye - 90 PSI - 4 Pack - 12" Rubber Hoses - Super Single
6095BC00	Cat's Eye - 95 PSI - 4 Pack - 12" Rubber Hoses - Super Single
6100BC00	Cat's Eye - 100 PSI - 4 Pack - 12" Rubber Hoses - Super Single
6105BC00	Cat's Eye - 105 PSI - 4 Pack - 12" Rubber Hoses - Super Single
6110BC00	Cat's Eye - 110 PSI - 4 Pack - 12" Rubber Hoses - Super Single
6115BC00	Cat's Eye - 115 PSI - 4 Pack - 12" Rubber Hoses - Super Single

CAT'S EYE: 4-UNIT BOX - STAINLESS STEEL, DUAL TIRES

6080BB00	Cat's Eye - 80 PSI - 4 Pack - 16" Stainless Steel - Dual Tires
6085BB00	Cat's Eye - 85 PSI - 4 Pack - 16" Stainless Steel - Dual Tires
6090BB00	Cat's Eye - 90 PSI - 4 Pack - 16" Stainless Steel - Dual Tires

Part Number	Description
-------------	-------------

6095BB00	Cat's Eye - 95 PSI - 4 Pack - 16" Stainless Steel - Dual Tires
6100BB00	Cat's Eye - 100 PSI - 4 Pack - 16" Stainless Steel - Dual Tires
6105BB00	Cat's Eye - 105 PSI - 4 Pack - 16" Stainless Steel - Dual Tires
6110BB00	Cat's Eye - 110 PSI - 4 Pack - 16" Stainless Steel - Dual Tires
6115BB00	Cat's Eye - 115 PSI - 4 Pack - 16" Stainless Steel - Dual Tires

CAT'S EYE: 4-UNIT BOX - STAINLESS STEEL, SUPER SINGLE

6080BJ00	Cat's Eye - 80 PSI - 4 Pack - 12" Stainless Steel - Super Single
6085BJ00	Cat's Eye - 85 PSI - 4 Pack - 12" Stainless Steel - Super Single
6090BJ00	Cat's Eye - 90 PSI - 4 Pack - 12" Stainless Steel - Super Single
6095BJ00	Cat's Eye - 95 PSI - 4 Pack - 12" Stainless Steel - Super Single
6100BJ00	Cat's Eye - 100 PSI - 4 Pack - 12" Stainless Steel - Super Single
6105BJ00	Cat's Eye - 105 PSI - 4 Pack - 12" Stainless Steel - Super Single
6110BJ00	Cat's Eye - 110 PSI - 4 Pack - 12" Stainless Steel - Super Single

SERVICE PARTS FOR CAT'S EYE

6000-3009	Universal Wheel Bracket
6000-3010	Universal Hub Bracket
6000-4312	Hose Protector - 6" length
6000-5032	16" Rubber Hose with Straight Hose End
6000-5832	6" Rubber Hose with 180° Hose End
6000-5082	16" Stainless Steel Hose with Straight Hose End
6000-5882	16" Stainless Steel Hose with 180° Hose End
6000-5028	14" Rubber Hose with Straight Hose End
6000-5828	14" Rubber Hose with 180° Hose End
6000-5078	14" Stainless Steel Hose with Straight End
6000-5878	14" Stainless Steel Hose with 180° Hose End
6000-5024	12" Rubber Hose with Straight Hose End
6000-5824	12" Rubber Hose with 180° Hose End
6000-5074	12" Stainless Steel Hose with Straight Hose End
6000-5874	12" Stainless Steel Hose with 180° Hose End
6000-9050	Valve Stem Repair Tool
6000-9060	Deluxe Valve Stem Repair Tool
6000-2019	Air Inlet Fitting
6000-4222	Replacement Seal Pack (24 seals)



*For information, updates, or corrections,
please contact us at TRPBus@TRPParts.com*

*No part of this marketing material may be
reproduced in any manner without written
permission from TRP® North America.*

TRP® North America

750 Houser Way N.
Renton, WA 98057

www.trpparts.com

PART NUMBER INDEX

Brakes	1		
1205E2527	1-73	2210D7674	1-92
1205F25828	1-73	2210D7700	1-92
1205G761	1-72	2210D7726	1-92
1205G761	1-73	2210D8220	1-92
1205Z2652	1-73	2210E7493	1-89
1225C1277	1-73	2210E7597	1-91
1225J1362	1-73	2210E7649	1-92
1225L1208	1-71	2210E7675	1-92
1225R512	1-70	2210E7701	1-92
1229D2942	1-72	2210E7727	1-92
1229E4685	1-72	2210E8351	1-94
1229F4686	1-73	2210E8403	1-93
1229G2971	1-72	2210F7416	1-88
1229H4090	1-73	2210F7442	1-89
1229J3130	1-73	2210F7468	1-89
1229R122	1-71	2210F7546	1-90
1229S2697	1-72	2210F8352	1-94
1229W3117	1-73	2210F8404	1-93
1229X1116	1-72	2210G7417	1-88
123573	1-132	2210G7443	1-89
1250J1284	1-73	2210G7469	1-89
141476	1-132	2210G7547	1-90
145086	1-132	2210G8353	1-94
18A643	1-132	2210G8431	1-87
18A808	1-132	2210H7418	1-88
2007173C1	1-132	2210H7496	1-89
2210A4915	1-86	2210H7522	1-90
2210A6007	1-87	2210H7626	1-91
2210A6813	1-86	2210H7652	1-92
2210A7515	1-90	2210H7730	1-93
2210A7593	1-91	2210H7782	1-93
2210A7619	1-91	2210H8354	1-94
2210A7645	1-91	2210H8432	1-87
2210A7671	1-92	2210J7420	1-88
2210A7697	1-92	2210J7498	1-89
2210A7749	1-93	2210J7524	1-90
2210A8217	1-92	2210J7628	1-91
2210B4916	1-86	2210J7654	1-92
2210B6008	1-87	2210J7732	1-93
2210B7412	1-88	2210J7784	1-93
2210B7464	1-89	2210J8330	1-88
2210B7542	1-90	2210K7265	1-90
2210B7568	1-90	2210K7343	1-88
2210B7594	1-91	2210K7395	1-88
2210B8218	1-92	2210K7473	1-89
2210B8582	1-94	2210K7499	1-89
2210C7413	1-88	2210K7551	1-90
2210C7465	1-89	2210K7603	1-91
2210C7543	1-90	2210K7837	1-91
2210C7569	1-90	2210K8331	1-88
2210C7595	1-91	2210L7266	1-90
2210C8219	1-92	2210L7344	1-88
2210C8583	1-94	2210L7396	1-88
2210D7492	1-89	2210L7474	1-89
2210D7596	1-91	2210L7500	1-89
2210D7648	1-92	2210L7552	1-90
		2210L7604	1-91
		2210L7838	1-91
		2210L8176	1-92
		2210L8332	1-91
		2210M7449	1-89
		2210M7501	1-89
		2210M7683	1-92
		2210M7787	1-93
		2210M8177	1-92
		2210M8333	1-91
		2210M8489	1-94
		2210N7450	1-89
		2210N7502	1-89
		2210N7684	1-92
		2210N7788	1-93
		2210N8282	1-92
		2210N8490	1-94
		2210P7374	1-88
		2210P7426	1-88
		2210P7452	1-89
		2210P7478	1-89
		2210P7530	1-90
		2210P7582	1-91
		2210P7608	1-91
		2210P7660	1-92
		2210P7842	1-89
		2210P8284	1-92
		2210Q4905	1-86
		2210Q5165	1-86
		2210Q7375	1-88
		2210Q7427	1-88
		2210Q7453	1-89
		2210Q7479	1-89
		2210Q7531	1-90
		2210Q7583	1-91
		2210Q7609	1-91
		2210Q7661	1-92
		2210Q7843	1-89
		2210Q8181	1-89
		2210Q8285	1-90
		2210R4906	1-86
		2210R7428	1-88
		2210R7454	1-89
		2210R7636	1-91
		2210R7688	1-92
		2210R7714	1-92
		2210R7766	1-93
		2210R7844	1-91
		2210R8182	1-89
		2210R8286	1-90
		2210S4907	1-86
		2210S7429	1-88
		2210S7455	1-89
		2210S7637	1-91
		2210S7689	1-92
		2210S7715	1-92
		2210S7767	1-93
		2210S7845	1-90
		2210S8183	1-89
		2210S8287	1-90
		2210T4908	1-86
		2210T7430	1-88

2210T7456	1-89	2210Z7696	1-92	65175B	1-48
2210T7534	1-90	2210Z7748	1-93	65176B	1-48
2210T7560	1-90	2210Z8216	1-90	65177B	1-48
2210T7586	1-91	2210Z8294	1-86	65179B	1-48
2210T7664	1-92	2210Z8346	1-89	65516B	1-48
2210T8184	1-89	221DF6298	1-86	65551B	1-48
2210T8288	1-90	221DG5753	1-86	65670B	1-49
2210U4909	1-86	221DG6299	1-86	65710B	1-48
2210U7431	1-88	221DH5754	1-86	66353B	1-49
2210U7457	1-89	221DK6303	1-86	66800B	1-49
2210U7535	1-90	221DK6537	1-86	66812B	1-49
2210U7561	1-90	221DL6304	1-86	66843B	1-49
2210U7587	1-91	221DL6538	1-86	66864B	1-49
2210U7665	1-92	221DN8204	1-86	66873B	1-49
2210U8315	1-90	221DP5164	1-86	68918B	1-49
2210U8341	1-91	221DP8200	1-86	68958B	1-49
2210U8393	1-91	221DW5535	1-86	68981B	1-49
2210V4910	1-86	221DX5536	1-86	68981B	1-49
2210V7484	1-89	2297X7304	1-73	69160441	1-111
2210V7510	1-90	23-123573-004	1-132	69160457	1-111
2210V7536	1-90	23-123648-002	1-132	69270757	1-111
2210V7614	1-91	2594594C1	1-132	71528B	1-48
2210V7666	1-92	2594595C1	1-132	76854B	1-49
2210V7692	1-92	3230008X	1-137	76864B	1-49
2210V7718	1-92	3230051X	1-137	76884B	1-49
2210V8316	1-90	3430008X	1-137	A1205K2533	1-73
2210V8342	1-91	3430051X	1-137	A1205V1556	1-70
2210V8394	1-91	3531661C2	1-132	A1205V1556	1-72
2210W7485	1-89	3531662C2	1-132	A1205V1556	1-73
2210W7511	1-90	4C4Z1125JA	1-132	A1250V1556	1-73
2210W7537	1-90	54102P	1-125	A4S8644	1-35
2210W7615	1-91	54103P	1-125	D6153	1-132
2210W7667	1-92	54104P	1-125	D6176M	1-132
2210W7693	1-92	54105P	1-125	D6178M	1-132
2210W7719	1-92	54106P	1-125	E10901840BXW	1-11
2210W8213	1-90	54251P	1-125	E10902240BXW	1-12
2210W8265	1-91	54255P	1-125	E10902250BXW	1-11
2210W8317	1-88	54256P	1-125	E10902360BXW	1-12
2210W8369	1-89	54280P	1-125	E10906550BXW	1-12
2210W8395	1-93	54281P	1-126	E10907860BXW	1-12
2210X7408	1-88	54282P	1-125	E10907861BXW	1-13
2210X7538	1-90	54301P	1-126	E10908020BXW	1-13
2210X7564	1-90	54351P	1-125	E11101840BXW	1-11
2210X7590	1-91	54352P	1-125	E11102240BXW	1-13
2210X8214	1-90	54360P	1-126	E11102250BXW	1-11
2210X8266	1-91	54769P-65	1-132	E11102360BXW	1-13
2210X8318	1-88	54770P-65	1-125	E11104110BXW	1-11
2210X8370	1-89	54771P65	1-126	E11106550BXW	1-13
2210X8396	1-93	54773P65	1-126	E11107170BXW	1-11
2210Y6005	1-87	54775P-65	1-132	E11107690BXW	1-13
2210Y7409	1-88	60050312	1-123	E11107770BXW	1-14
2210Y7539	1-90	60050313	1-123	E11107840BXW	1-14
2210Y7565	1-90	60050334	1-112	E11107860BXW	1-14
2210Y7591	1-91	60450454	1-123	E11107861BXW	1-14
2210Y8215	1-90	60450455	1-123	E11108020BXW	1-14
2210Y8293	1-86	60450473001	1-122	E11109740BXW	1-14
2210Y8345	1-89	60450474001	1-122	E11109741BXW	1-14
2210Z6006	1-87	60450482	1-124	E11109890BXW	1-15
2210Z6812	1-86	60450483	1-124	E11110640BXW	1-15
2210Z7514	1-90	61950B	1-48	E11110660BXW	1-15
2210Z7592	1-91	61991B	1-48	E11110670BXW	1-15
2210Z7618	1-91	65152B	1-48	E11110680BXW	1-15
2210Z7644	1-91	65163B	1-48	E11110690BXW	1-15
2210Z7670	1-92	65169B	1-48	E11113280BXW	1-15

E11113290BXW	1-12	E125-88-020	1-134	KSMA2124514QR	1-28
E11113300BXW	1-15	E12588020BXW	1-128	KSMA2124515Q	1-30
E-11470	1-132	E12588021	1-132	KSMA2124515QBL	1-30
E12570047BXW	1-131	E125-88-021	1-133	KSMA2124524Q	1-27
E12570048BXW	1-131	E125-88-021	1-134	KSMA2124551Q	1-32
E12570069BXW	1-129	E12588021BXW	1-127	KSMA2124702QP	1-26
E12570131BXW	1-131	E12588021BXW	1-132	KSMA2124702QPBL	1-26
E12570132BXW	1-129	E125-88-022	1-133	KSMA2124707QP	1-31
E125-84-019	1-133	E12588022BXW	1-128	KSMA2124707QPBL	1-31
E12584019BXW	1-129	E125-88-025	1-134	KSMA2124709E1	1-29
E125-84-020	1-133	E125-88-025	1-135	KSMA2124709E2	1-29
E12584020BXW	1-128	E12588025BXW	1-130	KSMA2124709E2BL	1-29
E125-84-021	1-133	E126-84-022	1-133	KSMA2124719E	1-26
E12584021BXW	1-131	E12684022BXW	1-129	KSMA2124725E	1-27
E125-84-025	1-133	E126-85-009	1-133	KSMA3104311E	1-28
E12584025BXW	1-129	E12685009BXW	1-129	KSMA3104514Q	1-28
E125-84-027	1-133	E14670092BXW	1-119	KSMA3104514QR	1-28
E12584027BXW	1-130	E14670093BXW	1-119	KSMA3104515Q	1-30
E125-84-028	1-133	E14670540BXW	1-119	KSMA3104524Q	1-27
E12584028BXW	1-130	E14675011BXW	1-119	KSMA3104702QP	1-26
E125-85-006	1-133	E14675012BXW	1-119	KSMA3104707QP	1-31
E12585006BXW	1-130	E14684013BXW	1-119	KSMA3104709E1	1-29
E125-85-007	1-133	E14684014BXW	1-119	KSMA3104709E2	1-29
E12585007BXW	1-131	E14684015BXW	1-119	KSMA3121443E	1-26
E125-85-010	1-133	E14684016BXW	1-119	KSMA3124311E	1-28
E12585010BXW	1-128	E14684017BXW	1-119	KSMA3124311EBL	1-29
E125-85-012	1-133	E14684018BXW	1-119	KSMA3124514Q	1-28
E12585012BXW	1-127	E14684019BXW	1-119	KSMA3124514QR	1-28
E125-85-013	1-133	E14685009BXW	1-119	KSMA3124515Q	1-30
E12585013BXW	1-127	E14688006BXW	1-119	KSMA3124524Q	1-27
E125-85-019	1-133	E14688014BXW	1-119	KSMA3124702QP	1-26
E12585019BXW	1-130	E14688015BXW	1-119	KSMA3124702QPBL	1-26
E125-85-020	1-133	E14770020BXW	1-119	KSMA3124707QP	1-31
E12585020BXW	1-131	E14770021BXW	1-119	KSMA3124707QPBL	1-31
E125-88-005	1-134	E14770036BXW	1-119	KSMA3124709E1	1-29
E12588005BXW	1-127	E14770037BXW	1-119	KSMA3124719E	1-27
E125-88-006	1-134	E14771014BXW	1-119	KSMA3124719R	1-27
E12588006BXW	1-129	E14771015BXW	1-119	KSMA3124725E	1-27
E125-88-007	1-134	E14775008BXW	1-119	KSMA3124725R	1-27
E12588007BXW	1-127	E14784106BXW	1-119	KSMA3124726R	1-32
E125-88-008	1-134	E14785008BXW	1-119	KSR3014311E	1-29
E12588008BXW	1-128	E14785012BXW	1-119	KSR3014514Q	1-28
E125-88-011	1-134	E14788008BXW	1-119	KSR3014514QR	1-28
E12588011BXW	1-127	E14788010BXW	1-119	KSR3014515Q	1-30
E125-88-012	1-133	E-6114	1-132	KSR3014524Q	1-27
E12588012BXW	1-131	GC3030LP40M1D	1-137	KSR3014551Q	1-32
E125-88-013	1-133	GC3030P40	1-137	KSR3014702QP	1-26
E12588013BXW	1-128	K1T8000	1-45	KSR3014707QP	1-31
E125-88-014	1-134	K1T8000MBHD	1-45	KSR3014709E1	1-29
E12588014BXW	1-127	K1T8080	1-46	KSR4034514Q	1-28
E125-88-015	1-134	K1T8081	1-46	KSR4034514QR	1-28
E12588015BXW	1-128	K1T8824HD	1-40	KSR4034515Q	1-30
E125-88-018	1-133	K1T8847HDA	1-40	KSR4034524Q	1-27
E12588018BXW	1-130	K1TD769AM	1-112	KSR4034707QP	1-31
E12588019	1-132	KSMA2104311E	1-28	LC3030P40	1-136
E125-88-019	1-133	KSMA2104515Q	1-29	LP3030KP40	1-136
E12588019BXW	1-130	KSMA2104524Q	1-27	MD1066	1-10
E12588019BXW	1-132	KSMA2104702QP	1-26	MD1067	1-10
E125-88-019	1-133	KSMA2104709E1	1-29	MD1068	1-10
E12588019BXW	1-130	KSMA2104709E2	1-29	MD1069	1-10
E12588019BXW	1-132	KSMA2121443E	1-26	MD1328	1-10
E125-88-020	1-133	KSMA2124311E	1-28	MD1329	1-17
		KSMA2124311EBL	1-28	MD1330	1-10
		KSMA2124514Q	1-27	MD184	1-16

MD224.....	1-9	PKSMA3124515QBL.....	1-30	R45B460.....	1-34
MD225.....	1-16	PKSMA3124707QP.....	1-31	R45B508.....	1-34
MD380.....	1-16	PKSR3014515Q.....	1-30	R45B512.....	1-34
MD411.....	1-16	PKSR3014707QP.....	1-31	R45B520.....	1-34
MD655.....	1-9	PLBPS-3030K.....	1-137	R45B530.....	1-34
MD769.....	1-112	PLBPS-3030KLS.....	1-137	R45B540.....	1-34
MD777.....	1-9	PLBTS-3030LS.....	1-137	R45B551.....	1-34
MD784.....	1-9	R4010771.....	1-114	R45B560.....	1-34
MD786.....	1-17	R4011511.....	1-112	R45B565.....	1-35
MD786A.....	1-17	R4011729.....	1-111	R45B568.....	1-35
MD802.....	1-9	R4011730.....	1-112	R45B608.....	1-34
MD974.....	1-17	R4011731.....	1-112	R45B612.....	1-34
MD989.....	1-9	R4011751.....	1-117	R45B630.....	1-34
MKT1308E.....	1-37	R4011752.....	1-117	R45B651.....	1-34
MKT409ES2N.....	1-44	R4011754.....	1-117	R45B660.....	1-34
MKT4311EHDN.....	1-41	R4011758.....	1-118	R4S8640.....	1-35
MKT4515HDN.....	1-47	R404153343.....	1-117	R507002.....	1-41
MKT4515QN.....	1-47	R4066365.....	1-115	R507004.....	1-37
MKT4709ESN.....	1-41	R4066780.....	1-111	R507057.....	1-42
MM786.....	1-118	R4090096.....	1-115	R507064.....	1-44
MM786A.....	1-117	R4090100P.....	1-114	R507077.....	1-42
MMCB466-4.....	7-26	R40H5010.....	1-115	R507084.....	1-43
MMD1064.....	1-10	R40H5519.....	1-111	R507085.....	1-43
MMD1066.....	1-10	R40H5522.....	1-115	R507094.....	1-44
MMD1067.....	1-10	R40HS010.....	1-111	R508030.....	1-40
MMD1068.....	1-10	R40S0021.....	1-113	R607015.....	1-84
MMD1069.....	1-10	R42R55604.....	1-120	R607016.....	1-84
MMD1328.....	1-10	R42R55605.....	1-120	R607017.....	1-84
MMD1329.....	1-17	R42R55855.....	1-122	R607018.....	1-84
MMD1330.....	1-10	R42R55856.....	1-122	R607029.....	1-84
MMD184.....	1-113	R42R55994.....	1-122	R607030.....	1-84
MMD224.....	1-111	R42R55995.....	1-121	R607035.....	1-84
MMD225.....	1-16	R42R65533.....	1-121	R607036.....	1-84
MMD380.....	1-16	R42R65534.....	1-121	R607105.....	1-85
MMD411.....	1-16	R42R65535.....	1-121	R607106.....	1-85
MMD655.....	1-9	R42R65536.....	1-121	R607111.....	1-85
MMD769.....	1-112	R457013701.....	1-36	R607112.....	1-85
MMD777.....	1-9	R457013702.....	1-36	R607117.....	1-70
MMD784.....	1-9	R457013703.....	1-36	R607118.....	1-70
MMD786.....	1-17	R458340.....	1-34	R607119.....	1-70
MMD786A.....	1-17	R458564.....	1-35	R607120.....	1-70
MMD802.....	1-9	R458566.....	1-35	R607121.....	1-70
MMD974.....	1-17	R458569.....	1-35	R607122.....	1-70
MMD989.....	1-9	R458570.....	1-35	R607123.....	1-70
MRS466-4.....	7-26	R458620.....	1-34	R607124.....	1-70
MT643WEL.....	11-6	R458639.....	1-35	R607125.....	1-84
MVD224.....	1-111	R458640.....	1-34	R607126.....	1-84
MVD225.....	1-116	R458641.....	1-35	R607127.....	1-69
MVD380.....	1-115	R458642.....	1-35	R607128.....	1-69
MVD769.....	1-112	R458643.....	1-35	R607129.....	1-69
MVD786.....	1-118	R458645.....	1-35	R607130.....	1-69
MVD786A.....	1-117	R458646.....	1-35	R607131.....	1-69
PFC381.081.20.....	1-126	R45B308.....	1-34	R607132.....	1-69
PFC381.181.30.....	1-126	R45B312.....	1-34	R607133.....	1-69
PKSMA2104515Q.....	1-30	R45B320.....	1-34	R607134.....	1-69
PKSMA2104707QP.....	1-31	R45B330.....	1-34	R607135.....	1-69
PKSMA2124515Q.....	1-30	R45B351.....	1-34	R607136.....	1-69
PKSMA2124515QBL.....	1-30	R45B360.....	1-34	R607137.....	1-69
PKSMA2124515QHD.....	1-30	R45B408.....	1-34	R607138.....	1-69
PKSMA2124707QP.....	1-31	R45B412.....	1-34	R607139.....	1-69
PKSMA2124707QPBL.....	1-31	R45B420.....	1-34	R607140.....	1-69
PKSMA3104515Q.....	1-30	R45B430.....	1-34	R607141.....	1-69
PKSMA3104707QP.....	1-31	R45B440.....	1-34	R607142.....	1-69
PKSMA3124515Q.....	1-30	R45B451.....	1-34	R607143.....	1-69

R607144.....	1-69	R802033.....	1-50	R802423.....	1-52
R607147.....	1-84	R802040.....	1-50	R802430.....	1-52
R607148.....	1-84	R802041.....	1-51	R802431.....	1-52
R607149.....	1-84	R802042.....	1-50	R802440.....	1-53
R607150.....	1-84	R802043.....	1-50	R802441.....	1-53
R607151.....	1-85	R802048.....	1-50	R802444.....	1-53
R607152.....	1-85	R802049.....	1-50	R802445.....	1-53
R607153.....	1-85	R802050.....	1-51	R802446.....	1-53
R607154.....	1-85	R802051.....	1-51	R802447.....	1-53
R607155.....	1-85	R802052.....	1-51	R802462.....	1-53
R607156.....	1-85	R802053.....	1-51	R802463.....	1-53
R607261.....	1-84	R802060.....	1-51	R802486.....	1-53
R607262.....	1-84	R802061.....	1-51	R802487.....	1-53
R607279.....	1-85	R802062.....	1-51	R802490.....	1-53
R607280.....	1-85	R802063.....	1-51	R802491.....	1-53
R607281.....	1-85	R802070.....	1-51	R802512.....	1-53
R607282.....	1-85	R802071.....	1-51	R802513.....	1-53
R607283.....	1-85	R802072.....	1-51	R802610.....	1-53
R607284.....	1-85	R802073.....	1-51	R802611.....	1-53
R627005.....	1-71	R802074.....	1-51	R802616.....	1-53
R627006.....	1-72	R802075.....	1-51	R802617.....	1-53
R627008.....	1-72	R802260.....	1-51	R802620.....	1-53
R627012.....	1-71	R802261.....	1-51	R802621.....	1-53
R627018.....	1-71	R802262.....	1-51	R802630.....	1-53
R627029.....	1-71	R802263.....	1-51	R802631.....	1-53
R627030.....	1-71	R802280.....	1-51	R802644.....	1-52
R627031.....	1-71	R802281.....	1-51	R802645.....	1-52
R627032.....	1-71	R802290.....	1-51	R802648.....	1-53
R627033.....	1-71	R802291.....	1-51	R802649.....	1-53
R657005.....	1-71	R802292.....	1-51	R802656.....	1-51
R801001.....	1-50	R802293.....	1-51	R802657.....	1-51
R801002.....	1-51	R802300.....	1-51	R802666.....	1-52
R801003.....	1-51	R802301.....	1-51	R802667.....	1-52
R801004.....	1-51	R802310.....	1-51	R802684.....	1-53
R801040.....	1-52	R802311.....	1-51	R802685.....	1-53
R801041.....	1-51	R802316.....	1-51	R806001.....	1-54
R801042.....	1-52	R802317.....	1-51	R806002.....	1-54
R801043.....	1-52	R802320.....	1-51	R806003.....	1-54
R801044.....	1-52	R802321.....	1-51	R806004.....	1-55
R801045.....	1-52	R802332.....	1-52	R806009.....	1-55
R801048.....	1-52	R802333.....	1-52	R806010.....	1-55
R801070.....	1-52	R802354.....	1-52	R806011.....	1-55
R801071.....	1-53	R802355.....	1-52	R806012.....	1-55
R801072.....	1-53	R802356.....	1-52	R806016.....	1-54
R801073.....	1-53	R802357.....	1-52	R806017.....	1-54
R801074.....	1-53	R802361.....	1-52	R806018.....	1-54
R801075.....	1-53	R802371.....	1-52	R806022.....	1-55
R801077.....	1-52	R802380.....	1-52	R806023.....	1-55
R801079.....	1-53	R802381.....	1-52	R806024.....	1-55
R801080.....	1-53	R802382.....	1-52	R806025.....	1-55
R801100.....	1-53	R802383.....	1-52	R806026.....	1-55
R801101.....	1-53	R802400.....	1-52	R806500.....	1-56
R801102.....	1-53	R802401.....	1-52	R806501.....	1-56
R802000.....	1-50	R802402.....	1-52	R806502.....	1-56
R802001.....	1-50	R802403.....	1-52	R806503.....	1-56
R802002.....	1-50	R802412.....	1-52	R806504.....	1-56
R802003.....	1-50	R802413.....	1-52	R806505.....	1-56
R802020.....	1-50	R802414.....	1-52	R806507.....	1-56
R802021.....	1-50	R802415.....	1-52	R806508.....	1-56
R802022.....	1-50	R802416.....	1-52	R806521.....	1-61
R802023.....	1-50	R802417.....	1-52	R806522.....	1-63
R802030.....	1-50	R802420.....	1-52	R806523.....	1-61
R802031.....	1-50	R802421.....	1-53	R806524.....	1-64
R802032.....	1-50	R802422.....	1-52	R806525.....	1-58

R806526.....	1-59	08-205741.....	2-29	09-869702.....	2-19
R806527.....	1-58	08-205833.....	2-29	222UPAC.....	21-9
R806528.....	1-59	08-205879.....	2-29	27403PW.....	2-4
R806529.....	1-59	08-205967.....	2-29	27404PKBLK21.....	2-4
R806530.....	1-61	09-001254.....	2-20	27404PKYEL21.....	2-5
R806531.....	1-62	09-001255.....	2-20	27404PW.....	2-4
R806532.....	1-59	09-001484.....	2-20	28157PG.....	2-4
R806533.....	1-59	09-001485.....	2-20	28440PKBLK21.....	2-4
R806534.....	1-61	09-001525.....	2-21	28440PKWHT21.....	2-5
R806535.....	1-57	09-001526.....	2-21	28869BLK21.....	2-4
R806536.....	1-57	09-001539.....	2-20	29001BLK21.....	2-4
R806537.....	1-59	09-001540.....	2-20	29001PKBLK21.....	2-4
R806538.....	1-60	09-001555.....	2-21	29001PKWHT21.....	2-4
R806539.....	1-62	09-001556.....	2-21	29001PW.....	2-4
R806540.....	1-62	09-001614.....	2-20	29195BLK21.....	2-4
R806541.....	1-60	09-001615.....	2-20	29195PW.....	2-4
R806542.....	1-62	09-001650.....	2-20	29300PKBLK21.....	2-5
R806543.....	1-58	09-001651.....	2-20	29300PKWHT21.....	2-5
R806544.....	1-60	09-001652.....	2-20	29300PW.....	2-4
R806545.....	1-60	09-001653.....	2-20	40008AOP.....	2-5
R806546.....	1-62	09-001727.....	2-26	40008A1P.....	2-5
R806547.....	1-61	09-001728.....	2-26	40008ANP.....	2-5
R806548.....	1-58	09-001763.....	2-20	41644ANP.....	2-5
R806549.....	1-57	09-001764.....	2-20	41644XP.....	2-5
R806550.....	1-63	09-001811.....	2-25	41644XPC.....	2-5
R806551.....	1-57	09-001853.....	2-25	50408BLK21.....	2-4
R806552.....	1-60	09-001855.....	2-25	50408PKWHT21.....	2-5
R806553.....	1-63	09-001910.....	2-21	50408PKYEL21.....	2-5
R806554.....	1-60	09-001911.....	2-21	50408PW.....	2-4
R806555.....	1-61	09-001958.....	2-26	50487PKBLK21.....	2-4
R806556.....	1-57	09-001964.....	2-25	50487PKWHT21.....	2-5
R806557.....	1-63	09-001965.....	2-20	50487PW.....	2-4
R806558.....	1-63	09-001966.....	2-20	R0010202L.....	2-22
R806559.....	1-58	09-001982.....	2-21	R0010202R.....	2-22
R806560.....	1-58	09-001983.....	2-21	R0010203L.....	2-22
R806563.....	1-64	09-001984.....	2-21	R0010203R.....	2-23
R806564.....	1-64	09-001985.....	2-21	R0010206L.....	2-23
R950055.....	1-33	09-001988.....	2-26	R0010206R.....	2-23
R950056.....	1-33	09-001989.....	2-26	R0010208L.....	2-23
R950057.....	1-33	09-001990.....	2-25	R0010208R.....	2-23
S4008508440.....	1-33	09-001991.....	2-21	R0010209L.....	2-23
S4008509150.....	1-33	09-001992.....	2-21	R0010209R.....	2-23
S4519004742.....	1-33	09-001995.....	2-21	R0010210L.....	2-23
S4519009242.....	1-33	09-001996.....	2-21	R0010210R.....	2-23
S4519009252.....	1-33	09-001997.....	2-21	R0010215.....	2-27
S4684139212.....	1-33	09-001998.....	2-21	R0010216.....	2-27
S4789010540.....	1-33	09-002001.....	2-26	R0010217.....	2-27
SB3030CC.....	1-137	09-002002.....	2-26	R0010218.....	2-27
SB3030CH.....	1-136	09-002003.....	2-26	R0010219.....	2-27
SB3030CL.....	1-136	09-002004.....	2-26	R0010220.....	2-27
SB3030PK.....	1-136	09-002005.....	2-26	R0010221.....	2-27
SB3030PKL.....	1-136	09-002013.....	2-26	R0010222.....	2-27
SC30.....	1-136	09-002047.....	2-19	R0010225L.....	2-19
		09-002048.....	2-19	R0010225R.....	2-19
		09-002049.....	2-21	R0010226L.....	2-18
		09-002050.....	2-21	R0010226R.....	2-18
		09-002085.....	2-21	R0010227L.....	2-18
		09-002086.....	2-21	R0010227R.....	2-18
		09-002184.....	2-27	R0010228L.....	2-18
		09-002204.....	2-20	R0010228R.....	2-18
		09-002205.....	2-20	R0010229.....	2-22
		09-002210.....	2-20	R0010234.....	2-16
		09-002211.....	2-19	R0010235.....	2-17
		09-869701.....	2-19	R0010242.....	2-27

Wheels 2

08-007591.....	2-29
08-205373.....	2-28
08-205435.....	2-29
08-205575.....	2-29
08-205740.....	2-29

R0010254L.....	2-16	R005047.....	2-36	R005783G.....	2-37
R0010254R.....	2-16	R005055.....	2-36	R005785G.....	2-35
R0010675.....	2-27	R005554L.....	2-16	R005796.....	2-28
R0010676.....	2-28	R005554R.....	2-16	R005798.....	2-28
R001124L.....	2-23	R005570.....	2-37	R005799.....	2-28
R001124R.....	2-23	R005571AG.....	2-37	R005800.....	2-28
R001607L.....	2-18	R005572AG.....	2-37	R005801.....	2-29
R001607R.....	2-18	R005573.....	2-33	R005820.....	2-37
R001623L.....	2-18	R005579L.....	2-16	R005821G.....	2-37
R001623R.....	2-18	R005579R.....	2-16	R005822.....	2-36
R001828.....	2-15	R005652L.....	2-16	R005823.....	2-36
R001905.....	2-22	R005652R.....	2-16	R005827G.....	2-37
R002002.....	2-30	R005702.....	2-29	R005828G.....	2-33
R004942.....	2-29	R005704.....	2-17	R005829G.....	2-35
R004944.....	2-29	R005706.....	2-32	R005837.....	2-37
R004945.....	2-29	R005708.....	2-17	R005838G.....	2-35
R004946.....	2-29	R005710.....	2-17	R005839.....	2-34
R004947.....	2-29	R005711.....	2-17	R005840.....	2-34
R004948.....	2-29	R005712.....	2-32	R005841.....	2-34
R004949.....	2-29	R005718L.....	2-25	R005868L.....	2-18
R004950.....	2-29	R005718R.....	2-25	R005868R.....	2-18
R004951.....	2-29	R005719L.....	2-25	R005869L.....	2-23
R004952.....	2-29	R005719R.....	2-25	R005869R.....	2-23
R004953.....	2-29	R005720L.....	2-25	R005870L.....	2-24
R004955.....	2-31	R005720R.....	2-25	R005870R.....	2-24
R004956A.....	2-32	R005721L.....	2-20	R005871L.....	2-25
R004957.....	2-32	R005721R.....	2-20	R005871R.....	2-25
R004958.....	2-31	R005722L.....	2-21	R005872.....	2-29
R004960.....	2-29	R005722R.....	2-21	R005882.....	2-35
R004961A.....	2-15	R005726.....	2-32	R005883.....	2-36
R004961A.....	2-15	R005727.....	2-32	R005885G.....	2-34
R004962.....	2-15	R005728.....	2-32	R005887.....	2-32
R004963.....	2-15	R005729.....	2-32	R005889.....	2-36
R004964L.....	2-23	R005734.....	2-17	R005890.....	2-34
R004964R.....	2-23	R005736.....	2-30	R005891.....	2-36
R004965L.....	2-23	R005737.....	2-30	R005892.....	2-16
R004965R.....	2-23	R005738.....	2-30	R005896L.....	2-25
R004966L.....	2-23	R005739.....	2-30	R005896R.....	2-25
R004966R.....	2-23	R005740.....	2-30	R005898L.....	2-17
R004967L.....	2-23	R005742.....	2-30	R005898R.....	2-17
R004967R.....	2-23	R005743.....	2-30	R005899L.....	2-17
R004968L.....	2-23	R005746.....	2-35	R005899R.....	2-17
R004968R.....	2-23	R005747.....	2-34	R005900L.....	2-25
R004969L.....	2-23	R005750L.....	2-17	R005900R.....	2-25
R004969R.....	2-23	R005750R.....	2-17	R005901.....	2-31
R004975R.....	2-16	R005753.....	2-35	R005902G.....	2-33
R004976R.....	2-15	R005754.....	2-33	R005904A.....	2-35
R004979R.....	2-16	R005755.....	2-36	R005905AG.....	2-36
R004987A.....	2-32	R005756L.....	2-24	R005906.....	2-34
R004989.....	2-32	R005756R.....	2-24	R005909L.....	2-20
R004989.....	2-32	R005757L.....	2-24	R005909R.....	2-20
R004990.....	2-32	R005757R.....	2-24	R005910L.....	2-20
R005007.....	2-15	R005761.....	2-32	R005910R.....	2-20
R005008.....	2-15	R005764L.....	2-24	R005911L.....	2-20
R005012.....	2-32	R005764R.....	2-24	R005911R.....	2-20
R005012.....	2-32	R005765L.....	2-24	R005926G.....	2-35
R005018.....	2-31	R005765R.....	2-24	R005927G.....	2-33
R005032.....	2-30	R005766L.....	2-24	R005944.....	2-28
R005033.....	2-34	R005766R.....	2-24	R005946.....	2-28
R005036.....	2-36	R005772.....	2-35	R005947.....	2-29
R005040AG.....	2-37	R005775.....	2-24	R005949.....	2-29
R005044.....	2-37	R005776.....	2-24	R005952.....	2-30
R005045.....	2-37	R005780.....	2-33	R005954.....	2-29
R005046.....	2-37	R005782.....	2-33	R005955.....	2-29

SPL 250.....	4-4
SPL170-4X.....	4-4
SPL250-4X.....	4-4
SS103.....	4-7
SS170.....	4-7
US170X.....	4-4
US170X.....	4-7
US250X.....	4-7

Steering 5

021407X1.....	5-6
026115.....	5-6
032308.....	5-6
1227S1527.....	5-13
EV201618L10101.....	5-5
EV221616L10106.....	5-5
EV221618L10106.....	5-5
EV221618R10106.....	5-5
PBR110FAA.....	5-6
PS221615R10301.....	5-5
PS221616L11301.....	5-5
PS221616L21301.....	5-5
PS221616L324A1.....	5-5
PS221616L334A1.....	5-5
PS221616R10301.....	5-5
PS221618L334A1.....	5-5
R002296.....	5-14
R002297.....	5-13
R002298.....	5-13
R002299.....	5-13
R002300.....	5-14
R002301.....	5-14
R002302.....	5-14
R002658.....	5-13
R002659.....	5-13
R002660.....	5-13
R002663.....	5-13
R003501.....	5-12
R003502.....	5-12
R003510.....	5-13
R004849.....	5-11
R004850.....	5-15
R004851.....	5-15
R004852.....	5-15
R004853.....	5-15
R004854.....	5-11
R004855.....	5-15
R004859.....	5-11
R004861.....	5-11
R004865.....	5-11
R004867.....	5-11
R004868.....	5-15
R004869.....	5-11
R004870.....	5-15
R004871.....	5-15
R004874.....	5-11
R004875.....	5-15
R004879.....	5-11
R006138.....	5-15
R006139.....	5-15

R230028.....	5-8
R230029.....	5-8
R230068.....	5-8
R230069.....	5-8
R230090.....	5-8
R230415.....	5-8
R230416.....	5-8
R250112.....	5-7
R250113.....	5-7
SK000282.....	5-6
SK000283.....	5-6
SK464.....	5-10
SK496.....	5-10
SK507.....	5-9
SK510.....	5-10
SK512.....	5-10
SK513.....	5-10
SK525.....	5-9
SK546.....	5-10
SK549.....	5-10
SK550.....	5-9
SK554.....	5-10
SK577.....	5-10
SK578.....	5-10
SK605.....	5-9
SK644.....	5-9
SK645.....	5-10
SK657.....	5-10
SK658.....	5-10
SK659.....	5-9
SK662.....	5-10
SK772.....	5-10
SK774.....	5-10
TAS550004.....	5-6
TAS55012.....	5-4
TAS65051A.....	5-4
TAS65115A.....	5-4
TAS65149A.....	5-4
TAS65175A.....	5-4
TAS655115.....	5-4

Suspension 6

89414.....	6-14
89414.....	6-14
0015222.....	6-13
0040015.....	6-14
0055008.....	6-15
0055017.....	6-15
0085990.....	6-15
0085991.....	6-14
0085991.....	6-15
0100-905.....	6-17
010134501-4.....	6-43
010134504-4.....	6-43
010134506-4.....	6-43
010134508-4.....	6-42
010134509.....	6-42
010234503-4.....	6-42
010234506.....	6-42
015813.....	6-25

020117504.....	6-42
020273541.....	6-42
020273541-4.....	6-43
020273544.....	6-42
020273546.....	6-42
020273547.....	6-42
020273547-4.....	6-43
020273548.....	6-42
020273549.....	6-42
020273549.....	6-43
0272-SS5.....	6-17
050134501-4.....	6-43
050134502-4.....	6-43
050134506-4.....	6-43
050134508.....	6-43
050134510.....	6-42
0501345-11.....	6-43
050134513.....	6-13
050134513.....	6-42
050230501.....	6-43
050231502-4.....	6-43
050231505.....	6-42
050231505.....	6-43
050231507.....	6-43
0523047.....	6-16
060231508.....	6-43
06-0367-00151.....	6-25
06-0367-00156.....	6-25
06-0367-00157.....	6-25
070131502.....	6-43
070131506.....	6-43
070231514.....	6-43
070231527.....	6-43
0823054.....	6-14
10 100-14.....	6-11
10 10U-13.....	6-11
1004167.....	6-15
10-13634-000.....	6-49
11 10.5-15.....	6-11
11 10.5-17.....	6-11
11 10.5C-16.....	6-11
12 TA-01-013.....	6-32
1217934.....	6-16
1260008.....	6-42
128745.....	6-49
12B-5-1.....	6-13
12J-5-10.....	6-13
12J-5-10.....	6-39
12J-5-10.....	6-41
12J-5-11.....	6-41
12L-5-100.....	6-39
12L-5-114.....	6-39
12L-5-88.....	6-13
12L-5-88.....	6-39
12L-5-89.....	6-39
12L-5-96.....	6-39
12L-5-97.....	6-39
12L-5-99.....	6-39
12L-5-99.....	6-50
1316546.....	6-15
134.....	6-38
15174902.....	6-21
15174902.....	6-32
1526417.....	6-14

15L-5-114.....	6-13
16-15676-000.....	6-27
16-16082-000.....	6-27
16-18708-000.....	6-49
16-19138-000.....	6-49
1658533.....	6-15
1667831.....	6-15
1668722.....	6-14
1668722.....	6-39
1668730.....	6-14
1675455C1.....	6-34
1677707C1.....	6-37
1690035C1.....	6-34
1690035C1.....	6-37
1707405.....	6-16
1722214.....	6-16
1722222.....	6-14
1746163.....	6-15
1750793.....	6-16
17700-007.....	6-75
17700-010.....	6-75
17700-035.....	6-59
17700-035.....	6-69
17730-015.....	6-63
17800-004.....	6-54
18831-021.....	6-59
18831-022.....	6-59
18831-023.....	6-59
1962422.....	6-16
1962430.....	6-16
1R11-039.....	6-11
1R11-204.....	6-11
1R12-095.....	6-11
1R12-132.....	6-11
1R12-188.....	6-11
1R12-505.....	6-11
1R12-512.....	6-11
1R13-039.....	6-11
1R14-115.....	6-11
1R14-147.....	6-11
1R8-009.....	6-11
1R9-003.....	6-11
1R9-003.....	6-11
1R9-038.....	6-11
1R9-041.....	6-11
1R9-065.....	6-11
200-171.....	6-28
20117501.....	6-42
20117503.....	6-42
20117505.....	6-42
2015557C1.....	6-37
2018987C1.....	6-37
2021459.....	6-16
2039549C1.....	6-37
204994R91.....	6-34
206620R91.....	6-34
206621R91.....	6-34
208664C91.....	6-34
210533R91.....	6-34
210534R92.....	6-34
210535R91.....	6-34
210919R91.....	6-35
21867-027.....	6-65
21867-035.....	6-65

21867-044.....	6-73
21867-045.....	6-73
22002293.....	6-19
22002294.....	6-19
22002295.....	6-19
2200327C1.....	6-37
22007701.....	6-19
22007702.....	6-29
22007750.....	6-19
22007751.....	6-20
22007752.....	6-20
22007753.....	6-30
22007757.....	6-30
22012067.....	6-25
22012079.....	6-40
22012079.....	6-50
22012090.....	6-21
22012090.....	6-31
22012090.....	6-32
22012091.....	6-21
22012091.....	6-32
22012095.....	6-18
22012095.....	6-20
22012095.....	6-30
22012095.....	6-31
22012096.....	6-17
22012096.....	6-18
22012096.....	6-20
22012096.....	6-28
22012096.....	6-30
22012096.....	6-31
22012096.....	6-31
22012114.....	6-25
22012166.....	6-31
22012169.....	6-31
22017530.....	6-21
22017531.....	6-21
22024061.....	6-25
22024062.....	6-24
22024506.....	6-24
22024506.....	6-33
22024673.....	6-39
22024673.....	6-41
22024673.....	6-50
22025066.....	6-24
22025066.....	6-33
22025067.....	6-25
22025067.....	6-33
22025305.....	6-33
22045526.....	6-41
22046485.....	6-50
22052014.....	6-41
22064231.....	6-21
22064232.....	6-21
22186-000.....	6-77
22962-001.....	6-59
22962-002.....	6-75
22962-007.....	6-54
22962-014.....	6-63
22962-027.....	6-75
22962-028.....	6-63
22962-031.....	6-76
22962-035.....	6-75
24-1700-106-149.....	6-40

24-1700-999-362.....	6-40
2516009.....	6-22
25-1700-101-426.....	6-40
25-1700-106-654.....	6-38
2B12-425.....	6-11
2B9-200.....	6-11
2B9-206.....	6-11
300-0614966.....	6-14
300-0614966.....	6-15
300-0614966.....	6-49
300-0614974.....	6-14
300-0614974.....	6-15
300-0823047.....	6-16
300-0823054.....	6-16
300-09612284.....	6-16
300-1316546.....	6-16
300-1317767.....	6-15
303-1350628.....	6-16
305-0961284.....	6-15
306444C91.....	6-35
308648C91.....	6-35
308649C91.....	6-35
308650C92.....	6-35
308664C91.....	6-35
308668C92.....	6-35
3166657.....	6-32
3178154.....	6-32
3178157.....	6-32
3192333.....	6-32
3192890.....	6-18
3192892.....	6-17
320444C91.....	6-35
329316C92.....	6-35
329316C92.....	6-35
34013-103.....	6-75
3533356C1.....	6-34
3533356C2.....	6-34
3605735C1.....	6-33
3605735C2.....	6-34
3633643.....	6-22
37042-002.....	6-75
37674-051.....	6-75
383379C91.....	6-35
39380353-6.....	6-22
39390340-4.....	6-22
453556C91.....	6-35
453561C91.....	6-35
453562C91.....	6-35
453564C91.....	6-35
453565C91.....	6-36
453567C91.....	6-36
453567C91.....	6-36
453568C91.....	6-36
453570C91.....	6-36
453574C91.....	6-36
453575C91.....	6-36
453579C91.....	6-36
467371C91.....	6-36
467371C91.....	6-37
467372C91.....	6-36
467983C91.....	6-36
467984C91.....	6-37
467985C91.....	6-37
471201C91.....	6-37

471203C91.....	6-37	57024-000.....	6-76	60240-000.....	6-55
472367C91.....	6-37	57096-002.....	6-75	60259-001.....	6-54
472411C91.....	6-37	57113.....	6-28	60259-002.....	6-54
472412C91.....	6-37	57131.....	6-28	60501-000.....	6-63
474002C91.....	6-37	57322-002.....	6-76	60508-000.....	6-55
47417.....	6-75	57356-000.....	6-76	6-05-1.....	6-23
4759272.....	6-16	57430-000.....	6-76	6-05-10.....	6-25
48-1-239.....	6-25	57430-003.....	6-76	60511-000.....	6-66
48-1-241.....	6-25	57724-000.....	6-75	60512-000.....	6-71
481700131250.....	6-41	58367-000.....	6-76	6-05-13.....	6-24
481700131252.....	6-41	58648-000.....	6-75	6-05-2.....	6-23
481700131438.....	6-14	586724C91.....	6-37	6-05-4.....	6-23
48531-014.....	6-75	586724C91.....	6-38	6-05-5.....	6-22
48574-000.....	6-75	58900-031.....	6-57	6-05-5.....	6-23
48718.....	6-75	58900-032.....	6-57	6-05-6.....	6-23
48718-104.....	6-75	58900-033.....	6-57	6-05-7.....	6-23
49175-026.....	6-75	58900-034.....	6-57	6-05-8.....	6-23
49177-006.....	6-76	58900-035.....	6-57	6-05-9.....	6-24
4940606.....	6-18	58900-036.....	6-57	60632-001.....	6-75
4940662.....	6-18	58900-051.....	6-57	60665-005.....	6-14
49684-014.....	6-75	58900-052.....	6-57	60779-000.....	6-75
49685-000.....	6-75	58900-053.....	6-57	60784-000.....	6-75
49689-000.....	6-77	58900-054.....	6-57	60850-001.....	6-71
4975467.....	6-19	58900-055.....	6-57	60903-016.....	6-67
4975494.....	6-19	58900-056.....	6-57	60903-046.....	6-54
4975497.....	6-19	58900-073.....	6-54	60903-055.....	6-57
4975510.....	6-19	58900-074.....	6-54	60904-001.....	6-61
4975515.....	6-40	58909-000.....	6-54	60904-002.....	6-57
4975518.....	6-24	58910-001.....	6-54	60904-034.....	6-54
49846-000.....	6-76	58913-007.....	6-15	609180.....	6-14
49983-000.....	6-77	58913-008.....	6-15	609180.....	6-15
501553C91.....	6-37	58913-009.....	6-16	60925-002.....	6-75
501553C91.....	6-38	58913-009L.....	6-66	60929-002.....	6-75
501905C91.....	6-38	58913-010L.....	6-57	60937-000.....	6-54
501906C91.....	6-37	58913-011.....	6-14	60952-XXX.....	6-57
501906C91.....	6-38	58913-011L.....	6-63	60961-009.....	6-54
501906C92.....	6-38	58937-000.....	6-54	60961-010.....	6-54
50216-000.....	6-76	58994.....	6-77	60961-011.....	6-58
50368-000.....	6-76	59013-000.....	6-63	60961-015.....	6-55
50763-004.....	6-76	59156-000.....	6-54	60961-025.....	6-54
50764-002.....	6-76	59423-002.....	6-66	60961-026.....	6-54
50764-003.....	6-76	59427-008.....	6-71	60961-027.....	6-58
50764-005.....	6-76	59427-013.....	6-53	60961-028.....	6-58
50765-000.....	6-75	59427-014.....	6-53	60961-039.....	6-54
53-14010.....	6-28	59428-004.....	6-53	60961-040.....	6-54
5316984.....	6-32	59428-005.....	6-63	60961-041.....	6-54
53-176.....	6-28	59428-006.....	6-71	60961-042.....	6-54
53-24685.....	6-28	59429-003.....	6-53	60961-043.....	6-54
537524C91.....	6-37	59483-000.....	6-14	60961-043.....	6-58
5392387.....	6-39	59828-000.....	6-54	60961-051.....	6-65
548532C1.....	6-38	59845-000.....	6-55	60961-052.....	6-65
5532026.....	6-23	59935-004.....	6-71	60961-069.....	6-55
5552451.....	6-21	59935-011.....	6-53	60961-137.....	6-67
5552452.....	6-21	59935-018.....	6-53	60961-138.....	6-67
5552456.....	6-21	59946-001.....	6-57	60961-139.....	6-67
5552552.....	6-21	59946-006.....	6-63	60961-140.....	6-69
56501-006.....	6-76	59952-003.....	6-69	60961-141.....	6-69
56501-019.....	6-76	59952-026.....	6-58	60961-142.....	6-59
56501-020.....	6-76	59952-030.....	6-55	60961-143.....	6-59
56501-021.....	6-76	59952-031.....	6-61	60961-144.....	6-59
56789-000.....	6-76	6 6.5-11.....	6-11	60961-145.....	6-59
56805-000.....	6-75	6 6.5-13.....	6-11	60961-146.....	6-65
56935-002.....	6-76	6 6.5B-11.....	6-11	60961-147.....	6-65
57022-010.....	6-75	60236-001.....	6-54	60961-161.....	6-66

60961-162.....	6-66	64536-010.....	6-59	67905-402.....	6-60
60961-163.....	6-71	64536-020.....	6-55	67905-404.....	6-60
60998-001.....	6-14	64536-025.....	6-59	67905-405.....	6-60
60998-002.....	6-14	64536-035.....	6-59	67905-407.....	6-60
61300112.....	6-49	64536-050.....	6-59	680010.....	6-49
61300-0114.....	6-50	64536-060.....	6-59	680029.....	6-25
61300224.....	6-49	64536-075.....	6-59	680054.....	6-49
61300240.....	6-49	64536-085.....	6-59	680088.....	6-49
61300285.....	6-49	64578-000.....	6-54	680091.....	6-17
6130029.....	6-49	64632-000.....	6-75	680091.....	6-43
61310101.....	6-49	64633-000.....	6-75	680155.....	6-16
61310102.....	6-49	64722-003.....	6-55	680231.....	6-41
61310103.....	6-49	64742-001.....	6-71	680232.....	6-41
61310104.....	6-49	64742-002.....	6-53	680271.....	6-43
61310232.....	6-49	64804-120.....	6-59	680274.....	6-43
61310434.....	6-49	64804-130.....	6-59	680307.....	6-40
61310478.....	6-49	64804-140.....	6-59	680308.....	6-40
614958.....	6-14	64804-150.....	6-59	680323.....	6-13
614958.....	6-15	64817-000.....	6-75	6803230300.....	6-27
614974.....	6-49	64905-002.....	6-57	680-323-0300.....	6-49
62000.....	6-77	64905-004.....	6-64	680326.....	6-41
6243-13790.....	6-13	64905-004.....	6-66	6803260000.....	6-27
6243-13790.....	6-51	64905-004.....	6-72	680-326-0000.....	6-49
6243-14040.....	6-13	64905-005.....	6-54	680328.....	6-43
63-0001.....	6-17	64905-005.....	6-57	680333.....	6-28
630127.....	6-44	64905-007.....	6-64	680350.....	6-50
630134.....	6-44	65000-002.....	6-57	680352.....	6-43
630136.....	6-44	650407.....	6-44	680378.....	6-43
630163.....	6-44	650407.....	6-44	680422.....	6-44
630252.....	6-44	651442.....	6-49	680470.....	6-41
630253.....	6-44	659287.....	6-49	680480.....	6-41
630253.....	6-44	65992-006.....	6-53	680481.....	6-41
6-367-1.....	6-25	66164-000.....	6-69	680645.....	6-45
6-367-11.....	6-25	66364-000.....	6-66	680667.....	6-16
6-367-12.....	6-25	66366-001.....	6-69	680783.....	6-16
6-367-14.....	6-25	665002.....	6-45	690029.....	6-32
6-367-16.....	6-25	665003.....	6-45	695110.....	6-28
6-367-17.....	6-25	66510-001.....	6-57	695117.....	6-39
6-367-2.....	6-25	665562.....	6-51	695125.....	6-24
6-367-3.....	6-25	665563.....	6-51	695273.....	6-50
6-367-4.....	6-25	665596.....	6-43	695279.....	6-50
6-367-6.....	6-25	665632.....	6-14	695327.....	6-43
6-367-7.....	6-25	66623-001.....	6-66	695343.....	6-43
6-367-8.....	6-25	66624-001.....	6-66	695366.....	6-43
6-367-9.....	6-25	66625-001.....	6-57	695389.....	6-43
64000-001.....	6-61	66626-001.....	6-57	695420.....	6-43
64000-002.....	6-61	66645-001.....	6-67	695421.....	6-43
64002-001.....	6-58	66645-001.....	6-73	695440.....	6-43
64002-002.....	6-58	66645-002.....	6-67	70039.....	6-17
64006-003.....	6-58	66666-000.....	6-59	70041.....	6-17
64075-002L.....	6-71	66699-001.....	6-67	70317.....	6-16
64080-000.....	6-59	66699-003.....	6-67	70397.....	6-16
64107-000.....	6-75	66805-001.....	6-63	70903-001.....	6-61
64108-000.....	6-75	66807-001.....	6-63	70952-318.....	6-54
64159-000.....	6-66	66814-001.....	6-65	70952-328.....	6-54
64246-000.....	6-54	66814-002.....	6-65	728802.....	6-49
64256-000.....	6-54	66825-001.....	6-63	74410.....	6-39
64272-000.....	6-75	66865-002L.....	6-63	74412.....	6-24
64314-000.....	6-57	671921.....	6-45	7805-M-1001.....	6-16
64316-000.....	6-66	671922.....	6-45	7805-N-1002.....	6-14
64488-002.....	6-57	671923.....	6-45	7805-S-1007.....	6-15
64506-000.....	6-69	67420-000.....	6-53	81-43701-6537.....	6-38
64516-001.....	6-73	67568-002.....	6-53	81-43701-6538.....	6-38
64519-000.....	6-69	67719-000.....	6-55	81-43701-6539.....	6-38

81-43701-6543	6-38	900 45 233	6-79	930 03 603	6-79
81-43701-6572	6-38	900 45 233	6-90	930 03 605	6-90
81-43701-6573	6-38	900 45 385	6-79	930 03 617	6-90
81-43701-6609	6-38	90044008	6-45	930 03 629	6-90
83127	6-14	90044011	6-45	930 03 635	6-79
85005	6-14	90044012	6-46	930 03 647	6-90
85013	6-14	90044016	6-46	930 03 831	6-79
85030	6-14	90044017	6-46	930 04 313	6-90
85051	6-14	90044025	6-46	934 00 136	6-79
85052	6-14	90044025	6-46	934 00 136	6-90
85304	6-14	90044025	6-46	934 00 417	6-79
85304	6-14	90044025	6-46	934 00 417	6-90
85307	6-14	90044046	6-47	934 00 490	6-90
85329	6-14	90044162	6-47	934 00 492	6-90
85337	6-14	90044448	6-14	934 00 494	6-79
85337	6-14	90044448	6-47	934 00 494	6-90
85700	6-13	90044642	6-47	934 00 496	6-79
85700	6-13	90044907	6-47	934 00 500	6-79
85708	6-13	90044907	6-47	934 00 502	6-90
85727	6-13	90044915	6-14	936 00 072	6-79
85729	6-13	90045031	6-47	936 00 072	6-90
85732	6-13	90045050	6-15	936 00 150	6-90
85733	6-13	90045050	6-47	936 00 156	6-79
85910	6-14	90045053	6-47	936 00 156	6-90
85919	6-13	90045068	6-47	936 00 162	6-79
85919	6-14	90045075	6-48	939 00 174	6-79
85959	6-14	90045083	6-14	97-2201-00001	6-25
87001-01A	6-16	90045084	6-48	97-2201-00001	6-33
87002	6-49	90045099	6-48	97-2201-00002	6-25
87-2519-00001	6-24	90045132	6-48	97-2201-00002	6-33
87-2519-00001	6-25	90045132	6-48	97-2201-00003	6-24
87-2519-00002	6-24	90045336	6-48	97-2201-00003	6-33
87-2519-00003	6-24	90045418	6-48	97-2201-00004	6-25
87-2519-00004	6-24	90045419	6-48	97-2201-00004	6-33
87-2520-00001	6-24	90045420	6-48	97-2201-00005	6-24
87-2520-00002	6-24	90045432	6-48	97-2201-00005	6-33
87-2520-00003	6-24	90045455	6-48	97-2201-00006	6-24
87-2520-00004	6-24	90045466	6-48	97-2201-00007	6-24
873622C91	6-37	90045504	6-48	97-2201-00008	6-24
874695R91	6-37	90045568	6-48	97-2201-00009	6-24
89430	6-14	90-1813	6-16	97-2201-00151	6-25
89432	6-14	90-1951-SP1	6-16	97-2201-00151	6-41
89440	6-14	90-1968	6-16	97-2210-00001	6-24
900 08 125	6-79	90-1968-SP1	6-16	97-2210-00001	6-33
900 08 125	6-90	9020M-1042	6-38	97-2210-00002	6-24
900 08 126	6-79	90-2610-SP1	6-42	97-2210-00002	6-33
900 08 194	6-79	90-2610-SP1	6-45	97-2210-00003	6-24
900 08 240	6-90	905 06 028	6-90	97-2210-00003	6-33
900 08 246	6-90	905 16 696	6-78	97-2210-00004	6-24
900 18 542	6-79	905 20 672	6-79	97-2210-00004	6-33
900 18 542	6-80	905 20 673	6-79	97-2210-00005	6-24
900 23 131	6-79	905 21 624	6-90	97-2210-00005	6-33
900 23 131	6-90	905 31 273	6-79	97-2210-00006	6-24
900 25 497	6-79	905 31 273	6-90	97-2210-00009	6-24
900 26 040	6-90	905 45 761	6-79	97-2210-00010	6-24
900 26 187	6-90	905 47 903	6-80	97-2210-00011	6-24
900 33 472	6-79	90F-1912	6-28	97-2210-00153	6-25
900 33 845	6-79	930 02 901	6-79	97-2210-00156	6-25
900 33 845	6-80	930 03 347	6-90	97-2210-00157	6-25
900 34 436	6-90	930 03 365	6-90	97-2210-00160	6-25
900 36 192	6-79	930 03 377	6-90	97-2210-00162	6-26
900 36 192	6-90	930 03 575	6-90	97-2210-00164	6-26
900 45 212	6-79	930 03 585	6-79	97-2210-00170	6-25
900 45 226	6-78	930 03 593	6-90	97-9999-00732	6-26

97-9999-02514	6-26	AS71170	6-11	D7HT-18080-BA	6-27
97-9999-02514	6-41	AS71800	6-5	D7HT-18080-DA	6-27
97-9999-02515	6-26	AS71800	6-10	D7HT-18080-DA	6-27
97-9999-02516	6-26	AS71800	6-11	DT1002002	6-40
97-9999-02519	6-26	AS80530	6-5	DT1802002	6-40
97-9999-02519	6-40	AS80530	6-7	DZ1002002	6-40
97-9999-02592	6-25	AS80530	6-11	E0HT-18045-AA	6-27
97-9999-02595	6-26	AS86160	6-11	E0HT-18045-AB	6-27
97-9999-02632	6-26	AS87390	6-11	E0HT-18080-AA	6-27
97-9999-02633	6-26	AS89000	6-5	F1HT-18045-AA	6-27
97-9999-02634	6-26	AS89000	6-10	FD 200-19	6-10
97-9999-02635	6-26	AS89000	6-11	FD 200-19	6-11
97-9999-02635	6-43	AS89370	6-11	FD 330-22	6-10
97-9999-02636	6-26	AS89970	6-5	FD 330-22	6-11
97-9999-02636	6-43	AS89970	6-11	FS 530-14	6-11
97-9999-807	6-26	AS90390	6-5	G1011822	6-39
9983-000	6-63	AS90390	6-11	G1011822	6-41
A1-6-134	6-33	AS90600	6-5	G1011822	6-50
A1-6-135	6-33	AS90600	6-11	G1011823	6-41
A-4890	6-16	AS91050	6-5	G1101590	6-41
A-4890	6-43	AS91050	6-11	G1101590	6-50
A-4890	6-50	AS91210	6-5	G1201338	6-41
AA1002002	6-40	AS91210	6-7	G1201339	6-41
AA1002003	6-40	AS91210	6-11	G1203223	6-41
AA1802002	6-40	AS91270	6-5	G5008070	6-41
AC1002002	6-40	AS91270	6-9	GBL654725	6-27
AC1002003	6-40	AS91270	6-11	GBL654725	6-49
AMS65109	6-14	AS92230	6-5	GBL665538	6-27
AMS65110	6-14	AS92230	6-10	GBL665538	6-49
AS52980	6-5	AS92230	6-11	GJ1002002	6-40
AS52980	6-8	AS92360	6-11	GJ1002003	6-40
AS52980	6-11	AS93250	6-5	H01500UN	6-12
AS53000	6-5	AS93250	6-8	H01501PUD	6-12
AS53000	6-6	AS93250	6-11	H01501UD	6-12
AS53000	6-11	AS93850	6-5	HCV-UN007	6-12
AS53100	6-5	AS93850	6-9	KD2454	6-12
AS53100	6-6	AS93850	6-11	M00 18 038	6-80
AS53100	6-11	AS94390	6-5	M00 18 041	6-80
AS53110	6-5	AS94390	6-8	MM1002002	6-40
AS53110	6-6	AS94390	6-11	MM1002003	6-40
AS53110	6-11	AS94400	6-5	N16248	6-41
AS53150	6-5	AS94400	6-8	N16249	6-41
AS53150	6-7	AS94400	6-11	N21543	6-41
AS53150	6-11	AS94650	6-5	N22212	6-41
AS53160	6-5	AS94650	6-9	N31830	6-41
AS53160	6-9	AS94650	6-11	N31831	6-41
AS53160	6-11	AS94650	6-11	OB3166657	6-43
AS54060	6-5	AS99590	6-11	OE 10086S	6-41
AS54060	6-6	AS99590	6-11	OE 13424S	6-38
AS54060	6-11	AS99610	6-5	S6009B	6-45
AS54090	6-5	AS99610	6-7	W013509325	6-11
AS54090	6-11	AS99610	6-11	W013585298	6-11
AS563B	6-45	AS99610	6-11	W013585300	6-11
AS69000	6-5	AS99610	6-11	W013585310	6-11
AS69000	6-10	AS99610	6-11	W013585311	6-11
AS69000	6-11	BN1002002	6-40	W013585315	6-11
AS69000	6-11	BT1002011	6-40	W013585316	6-11
AS69050	6-5	C2TA-18045-A	6-26	W013585406	6-11
AS69050	6-7	CI 1002003	6-40	W013585409	6-11
AS69050	6-11	CL1002003	6-40	W013587180	6-11
AS69100	6-6	D2TF-18045-GA	6-26	W013588053	6-11
AS69100	6-11	D2TF-18080-HA	6-26	W013588616	6-11
AS71170	6-5	D7HT-18045-GA	6-27	W013588900	6-11
AS71170	6-8	D7HT-18080-AA	6-27	W013588997	6-11

W013589039	6-11	2006-3511	7-7	4735-42622-27	7-20
W013589105	6-11	2006-3511	7-8	4735-42622-505	7-21
W013589223	6-11	2006-3512	7-7	4735-42622-512	7-21
W013589439	6-11	2006-3512	7-8	4735-42623-02	7-20
W013589440	6-11	2006-3513	7-8	4735-42623-09	7-21
W013589959	6-11	2006-3513	7-8	4735-42623-41	7-20
W013676900	6-11	2006-3517	7-7	4735-42623-505	7-21
W013676905	6-11	2006-3517	7-7	4735-42623-512	7-21
W013676910	6-11	2006-3523	7-8	4735-42904-02	7-19
W013679961	6-11	2006-3523	7-8	4735-42904-06	7-19
W016537117	6-11	4043-41130-01	7-14	4735-42904-77	7-19
W016539121	6-11	4401-1701	7-12	4735-43217-02	7-20
W01W358739	6-11	4401-1701	7-13	4735-43217-20	7-20
W01W358937	6-11	4401-1705	7-12	4735-43217-24	7-20
W01W359060	6-11	4401-1705	7-13	4735-43440-01	7-20
W01W359127	6-11	4401-1709	7-12	4735-43440-02	7-20
W01W359236	6-11	4401-1709	7-13	4735-43440-04	7-20
W01W359385	6-11	4401-1712	7-12	4735-43440-10	7-20
W01W359465	6-11	4401-1712	7-13	4735-43440-18	7-20
		4401-1714	7-12	4735-43480-27	7-20
		4401-1714	7-13	4735-43782-17	7-20
		4401-1715	7-12	4735-43783-05	7-20
		4401-1715	7-13	4735-43783-17	7-20
		4401-3504	7-12	4735-43783-29	7-20
		4401-3504	7-13	4735-43786-03	7-20
		4406-3501	7-12	4735-43889-25	7-19
		4406-3501	7-13	4735-44566-06	7-20
		4406-3502	7-12	4735-44616-01	7-21
		4406-3502	7-13	990001	7-16
010011656	7-20	4735-35828-124	7-19	990002	7-16
010021288	7-14	4735-35828-14	7-19	990052	7-16
010021488	7-14	4735-35828-21	7-19	990052	7-17
010021530	7-14	4735-35828-32	7-19	990053	7-16
010021994	7-14	4735-35828-34	7-19	990072	7-17
010024281	7-14	4735-35828-37	7-19	990075	7-17
1033-09340-01	7-14	4735-35828-98	7-19	990088	7-17
1056-07996-01	7-21	4735-35828-99	7-19	990128	7-17
1090-09000-01	7-14	4735-38449-06	7-21	990128	7-17
1097-09115-01	7-21	4735-38449-09	7-21	990139	7-16
17690-1A	7-14	4735-38449-70	7-21	990158	7-16
17858-1	7-14	4735-41135-06	7-19	9904015	7-18
2001-1704	7-6	4735-41296-10	7-19	9904026	7-18
2001-1704	7-6	4735-41296-117	7-19	991453	7-17
2001-1705	7-6	4735-41391-09	7-20	996043	7-17
2001-1705	7-6	4735-41392-02	7-20	996088	7-17
2001-1706	7-6	4735-41392-07	7-20	996132	7-17
2001-1706	7-6	4735-41392-22	7-20	996134	7-17
2001-1707	7-6	4735-41392-64	7-20	996147	7-16
2001-1707	7-6	4735-41392-76	7-20	996611	7-17
2001-1714	7-7	4735-41392-78	7-20	996612	7-17
2001-1714	7-8	4735-41393-01	7-20	996708	7-17
2001-1716	7-6	4735-41393-05	7-20	996710	7-17
2001-1716	7-6	4735-41393-07	7-20	996711	7-16
2006-3501	7-7	4735-41393-08	7-20	999157	7-15
2006-3501	7-7	4735-41393-14	7-20	999289	7-15
2006-3502	7-7	4735-41393-34	7-20	999291	7-15
2006-3502A	7-7	4735-41393-80	7-20	999292	7-15
2006-3505A	7-7	4735-42599-04	7-21	999337	7-16
2006-3506A	7-8	4735-42621-09	7-20	999453	7-16
2006-3506A	7-8	4735-42622-01	7-20	999457	7-15
2006-3507	7-7	4735-42622-02	7-20	999717	7-16
2006-3507	7-7	4735-42622-09	7-21	999853	7-16
2006-3508	7-7	4735-42622-113	7-21	99A9859	7-15
2006-3509	7-8	4735-42622-125	7-20	M1801191C91	7-30
2006-3509	7-8				
2006-3510	7-7				
2006-3510	7-8				

Engine 7

M1802337C1	7-28	M1822322	7-31	M1830726C91	7-35
M1802340C1	7-28	M1822322	7-32	M1833095C93	7-36
M1802666C92	7-30	M1822322	7-32	M1833382C1	7-34
M1802867C1	7-29	M1822322	7-32	M1833446	7-30
M1808059C92	7-27	M1822322	7-33	M1833564C92	7-37
M1808060C92	7-27	M1822379	7-35	M183566	7-30
M1808061C92	7-27	M1822389	7-35	M1836020C91	7-35
M1808062C92	7-27	M1822486	7-35	M1836192C91	7-32
M1808069C92	7-28	M1822487	7-35	M1836193C91	7-32
M1808070C92	7-28	M1822488	7-35	M1836195C96	7-31
M1808071C92	7-28	M1822490	7-35	M1836299C91	7-32
M1808072C92	7-28	M1822491	7-35	M1836300C94	7-31
M1808832C92	7-30	M1822492	7-35	M1836321C1	7-32
M1809570C1	7-28	M1822494	7-35	M1841326C1	7-31
M1809570C2	7-34	M1822495	7-35	M1841391C91	7-30
M1809570C2	7-34	M1822496	7-35	M1841938C1	7-36
M1809964C92	7-28	M1823181C92	7-37	M1842053C1	7-35
M1810171C2	7-30	M1823182C95	7-37	M1842054C1	7-35
M1810504C1	7-26	M1823313	7-31	M1842115C1	7-31
M1823875C2	7-26	M1823875C2	7-33	M1842227C1	7-33
M1810510C3	7-29	M1823925C1	7-33	M1842551C92	7-31
M1810744C1	7-28	M1823925C1	7-34	M1842554C93	7-33
M1811581C91	7-26	M1824461	7-31	M1842556C94	7-31
M1813933C96	7-29	M1824644C1	7-34	M1842566C92	7-36
M1813962C1	7-29	M1824644C1	7-34	M1842567C92	7-36
M1815264C1	7-26	M1824647C1	7-34	M1842570C92	7-35
M1815374C1	7-26	M1824647C1	7-34	M1842588C93	7-37
M1815538C91	7-30	M1824680C1	7-33	M1842592C91	7-37
M1815668C93	7-29	M1824680C1	7-34	M1842622C2	7-31
M1815674C1	7-31	M1824683C1	7-33	M1842623C93	7-37
M1815674C1	7-32	M1824683C1	7-34	M1842624C92	7-37
M1817247C91	7-25	M1824840C1	7-33	M1842626C95	7-37
M1817247C91	7-31	M1824840C1	7-34	M1842661C95	7-31
M1817247C91	7-32	M1824966	7-31	M1842662C91	7-37
M1817254C96	7-29	M1824970C99	7-36	M1842663C93	7-37
M1817520C2	7-25	M1824984C94	7-36	M1842889C91	7-36
M1817645	7-25	M1824985C97	7-36	M1842890C91	7-36
M1817661C91	7-26	M1825540C1	7-34	M1842891C91	7-36
M1817687	7-37	M1825540C1	7-34	M1842892C91	7-36
M1817867C92	7-36	M1825585	7-31	M1842893C91	7-36
M1818552	7-31	M1825690	7-31	M1842894C91	7-36
M1818552	7-31	M1826471C1	7-34	M1842900C92	7-35
M1818552	7-32	M1827121C2	7-34	M1842901C92	7-35
M1818598C1	7-35	M1830060C1	7-32	M1842902C92	7-35
M1818702	7-31	M1830060C1	7-32	M1847682C2	7-32
M1818702	7-31	M1830060C1	7-33	M1850402C91	7-32
M1818702	7-32	M1830256C93	7-37	M1850403C92	7-32
M1818702	7-32	M1830310C2	7-34	M1858121C1	7-32
M1818702	7-32	M1830311C2	7-34	M1872733C2	7-35
M1818702	7-32	M1830375C1	7-32	M1874253C1	7-31
M1818702	7-33	M1830565C91	7-32	M1874253C1	7-32
M1818702C1	7-31	M1830591C2	7-33	M1876098C91	7-32
M1818702C1	7-32	M1830596C91	7-36	M1876100C92	7-32
M1818702C1	7-33	M1830597C91	7-36	M1879703C94	7-31
M1818778C2	7-34	M1830706C1	7-32	M1879705C93	7-31
M1821900C1	7-33	M1830706C1	7-33	M1880991C94	7-31
M1821901C1	7-33	M1830711C1	7-34	M1885597C92	7-31
M1821902C1	7-33	M1830712C1	7-34	M1885598C91	7-37
M1821903C3	7-33	M252483R1	7-30	M252483R1	7-30
M1821904C3	7-33	M1830720C94	7-36	M253660R2	7-29
M1821905C3	7-33	M1830723C92	7-33	M326874R1	7-25
M1822321	7-35	M1830724C92	7-32	M326874R1	7-26
M1822322	7-31	M1830724C92	7-33	M327185R91	7-27
		M1830725C91	7-35	M41339D	7-26

M59658D.....	7-29
M670073C2.....	7-29
M670079C3.....	7-29
M670675C1.....	7-25
M671559C1.....	7-26
M671561C1.....	7-26
M671563C1.....	7-26
M671565C1.....	7-26
M671821C2.....	7-29
M671827C4.....	7-29
M673973C4.....	7-29
M674399C96.....	7-29
M674754C1.....	7-29
M675006C1.....	7-27
M675046C4.....	7-26
M675109C3.....	7-29
M675424C1.....	7-35
M675439C1.....	7-26
M675442C1.....	7-27
M675477C1.....	7-29
M675513C1.....	7-29
M675609C1.....	7-29
M675669C92.....	7-28
M675774C2.....	7-26
M675812C2.....	7-29
M676865C4.....	7-26
M677082.....	7-29
M677349C1.....	7-26
M677692C2.....	7-29
M680084.....	7-29
M680086C1.....	7-26
M680117C1.....	7-27
M680117C1.....	7-35
M680899C2.....	7-30
M681234C1.....	7-26
M681314C3.....	7-27
M681315C3.....	7-27
M681316C3.....	7-27
M682064C1.....	7-26
M682199C2.....	7-29
M682840C1.....	7-27
M683791C2.....	7-29
M684570C93.....	7-27
M684573C93.....	7-27
M684576C93.....	7-27
M684579C93.....	7-27
M684582C93.....	7-27
M684585C93.....	7-27
M685155C94.....	7-30
M687382C3.....	7-27
M687391C3.....	7-27
M687394C3.....	7-27
M688928C2.....	7-29
M690437C93.....	7-28
M690437C95.....	7-36
M911776R3.....	7-28
MC0H4664E.....	7-25
MC0H4664L.....	7-25
MC0H7520E.....	7-25
MC0H7520L.....	7-25
MC1F4664E.....	7-25
MC1F4664L.....	7-25
MC1F7520E.....	7-25
MC1F7520L.....	7-25

MCB1815668.....	7-29
MCB674399.....	7-29
MCK466-4.....	7-26

Air Systems 8

065018.....	8-19
065104.....	8-36
065125.....	8-37
065147.....	8-37
065181.....	8-36
065206.....	8-38
065213.....	8-34
065214.....	8-34
065303.....	8-38
065309.....	8-37
065311.....	8-34
065347.....	8-34
065546.....	8-37
065643.....	8-28
065661.....	8-28
065690.....	8-28
102344N.....	8-33
102626N.....	8-36
102802N.....	8-39
102846N.....	8-39
103009N.....	8-37
103081N.....	8-30
103912.....	8-36
104246N.....	8-43
104463.....	8-34
108123.....	8-41
109523.....	8-39
228687N.....	8-46
228688.....	8-46
228750N.....	8-43
229813N.....	8-33
229844N.....	8-33
229859N.....	8-33
229860N.....	8-33
260519.....	8-33
275083N.....	8-43
275200N.....	8-19
275491N.....	8-19
275508N.....	8-19
275530N.....	8-19
275707N.....	8-19
276121N.....	8-19
276566N.....	8-28
276567N.....	8-28
276599N.....	8-43
277147N.....	8-31
277148N.....	8-31
277155N.....	8-43
277222N.....	8-31
277226N.....	8-31
277227N.....	8-31
277486N.....	8-19
278450N.....	8-28
278483N.....	8-33
278595N.....	8-27
278596N.....	8-27

278597N.....	8-27
278598N.....	8-27
278614N.....	8-27
278615N.....	8-27
279416N.....	8-43
279472.....	8-43
279505N.....	8-31
280530N.....	8-43
280743N.....	8-43
280809N.....	8-27
280915.....	8-19
281024N.....	8-33
281126N.....	8-28
281467N.....	8-31
281587N.....	8-28
282517N.....	8-31
283029N.....	8-43
283657N.....	8-19
283828N.....	8-28
283861.....	8-30
284142.....	8-40
284143.....	8-40
284358N.....	8-19
284793N.....	8-43
284833N.....	8-43
285849.....	8-40
285850.....	8-40
286171N.....	8-21
286364N.....	8-41
286500N.....	8-31
287366.....	8-31
287368N.....	8-21
287368N.....	8-21
287417N.....	8-28
287600N.....	8-28
288063N.....	8-41
288251N.....	8-33
288323N.....	8-31
288522.....	8-43
289042N.....	8-33
289335.....	8-21
289335.....	8-22
289397N.....	8-43
289525N.....	8-33
296010N.....	8-38
5002831.....	8-39
5004029.....	8-39
5004049.....	8-19
5006939.....	8-28
5007834.....	8-19
5009593.....	8-24
5009594.....	8-24
5019319.....	8-22
800034.....	8-28
800063.....	8-34
800064.....	8-34
800095.....	8-38
800142.....	8-28
800219.....	8-34
800238.....	8-37
800305.....	8-37
800309.....	8-28
800361N.....	8-19
800365.....	8-36

800365.....	8-37
800366.....	8-37
800369.....	8-26
800370.....	8-26
800372.....	8-26
800373.....	8-26
800374.....	8-26
800375.....	8-26
800376.....	8-26
800439.....	8-34
800441.....	8-38
800483.....	8-38
800484.....	8-38
800485.....	8-38
800486.....	8-38
800508.....	8-38
800599.....	8-21
800620.....	8-28
800629.....	8-21
800630.....	8-21
800631.....	8-21
800632.....	8-21
800841.....	8-28
801144.....	8-26
801315.....	8-28
801526.....	8-45
801593.....	8-45
802123.....	8-45
802124.....	8-45
802741.....	8-33
802742.....	8-34
802743.....	8-33
802744.....	8-34
802745.....	8-33
802911.....	8-21
802924.....	8-21
BR950011.....	8-14
K021557.....	8-41
K021558.....	8-41
K021559.....	8-41
K021560.....	8-41
K021562.....	8-41
K021563.....	8-41
K039060.....	8-24
R109994.....	8-13
R95.....	8-8
R950070.....	8-8
R950071.....	8-8
R950072.....	8-8
R950073.....	8-8
R950074.....	8-8
R950075.....	8-7
R950076.....	8-7
R950077.....	8-28
R950078.....	8-7
R950079.....	8-7
R950080.....	8-7
R950081.....	8-7
R950082.....	8-34
R950083.....	8-7
R950084.....	8-7
R950085.....	8-10
R950086.....	8-10
R950087.....	8-8

R950088.....	8-8
R950089.....	8-8
R950090.....	8-8
R950091.....	8-9
R950092.....	8-9
R950093.....	8-9
R950093.....	8-9
R950094.....	8-9
R950095.....	8-7
R950096.....	8-7
R950097.....	8-7
R950098.....	8-7
R950099.....	8-9
R950100.....	8-9
R950101.....	8-9
R950102.....	8-9
R950103.....	8-9
R950104.....	8-9
R950105.....	8-9
R950106.....	8-9
R950107.....	8-9
R950108.....	8-10
R950109.....	8-10
R950110.....	8-10
R950111.....	8-10
R955065624N.....	8-13
R955103981N.....	8-13
R955106439X.....	8-17
R955107514X.....	8-18
R955107796N.....	8-13
R955108804X.....	8-18
R955109219X.....	8-17
R955109477X.....	8-13
R955109578N.....	8-13
R955109685N.....	8-13
R955205.....	8-14
R955277147N.....	8-32
R955286528X.....	8-18
R955286934X.....	8-13
R955336.....	8-6
R955338.....	8-6
R955341.....	8-6
R955342.....	8-6
R955500.....	8-11
R9555004613X.....	8-18
R9555004614X.....	8-18
R955500-BK.....	8-11
R955501-BK.....	8-11
R955800405N.....	8-13
R955KN23000N.....	8-26
R955KN23010N.....	8-26
R955KN31000X.....	8-32
RKN20021.....	8-29
RKN25060.....	8-27
RKN3211.....	8-35
S400.....	8-50

Emissions 9

30-12S.....	9-8
40-12S.....	9-8
61240184.....	9-7

62240582.....	9-7
A11-0341.....	9-5
A11-0364.....	9-5
A11-0368.....	9-5
A11-0373.....	9-5
A11-0386.....	9-5
A11U0339.....	9-5
A11U0403.....	9-5
A16-0133.....	9-3
A17-0527.....	9-3
A17-0580.....	9-3
A17-0584.....	9-3
A17-1200.....	9-3
A17-1213.....	9-3
A17-1216.....	9-3
A17-1217.....	9-3
A19-0086.....	9-6
A19-0114.....	9-6
A19-0143.....	9-5
A19-0149.....	9-6
A19-0158.....	9-6
A19-0168.....	9-5
A19-0175.....	9-5
A19U0155.....	9-5
A19U0162.....	9-5
A19U0169.....	9-6
A19U0203.....	9-5
A56-0062.....	9-6
A69-0029.....	9-6
A69-0030.....	9-6
C18-0014.....	9-5
EC20GZ.....	9-7
EC35FBZ.....	9-7
EC35GZ.....	9-7
EC40FBC.....	9-7
EC40FBZ.....	9-7
EC40GZ.....	9-7
EC40HD.....	9-7
EC50FBC.....	9-7
EC50FBZ.....	9-7
EC50GZ.....	9-7
EC50HD.....	9-7
EC60FBC.....	9-7
EC60FBZ.....	9-7
EC60GZ.....	9-7
EF4012SL.....	9-8
EF4018SL.....	9-8
EF4024SL.....	9-8
EF40300SL.....	9-7
EF4036SL.....	9-8
EF40STR120.....	9-8
EF5012SL.....	9-8
EF5018SL.....	9-8
EF5024SL.....	9-8
EF50300SL.....	9-7
EF5036SL.....	9-8
EMM10102.....	9-8
EMM10108.....	9-8
EMM10127.....	9-8
EN40CN304A.....	9-8

Cold Weather 10

25.2823.25.0500.OZ	10-3
25.2823.25.0501.OZ	10-3
25.2823.25.0505.OZ	10-3
25.2823.25.0506.OZ	10-3
25.2824.34.1000.OZ	10-3
25.2824.70.0800.OZ	10-3
25.2824.72.1200.OZ	10-3
25.2824.72.1201.OZ	10-3
25.2824.72.1205.OZ	10-3
25.2824.73.1200.OZ	10-3
310-0043	10-6
310-0044	10-6
350-0015	10-5
350-0016	10-5
350-0022	10-5
350-0030	10-5
350-0032	10-5
350-0043	10-6
350-0044	10-6
350-0054	10-6
350-0069	10-6
350-0081	10-5
5001544AWNA	10-4
860-0015	10-6
860-0031	10-6
860-0996	10-6
860-1666	10-5
860-1852	10-5
923317WNA	10-4
923326WNA	10-4
DD8L101W0C	10-5
FP151-001W0C	10-5
S446	10-6
TF751-002W0C	10-5

Transmissions 11

15986036MAS	11-3
15986036MAS	11-4
2100PTSWEL	11-6
2200PTSWEL	11-6
23015179MAS	11-4
2500PTSWEL	11-6
29500307MAS	11-4
29505061MAS	11-4
29505388MAS	11-4
29508650MAS	11-4
29509167MAS	11-4
29512406MAS	11-4
29514623MAS	11-4
29514624MAS	11-4
29542158MAS	11-4
3000PTSWEL	11-6
AT545NWEL	11-6
AT545WEL	11-6
AT545WELC	11-3
B210WEL	11-6
B220WEL	11-6
B300RWEL	11-6

B300WEL	11-6
B400PRWEL	11-6
B400RWEL	11-6
B400WEL	11-6
B500RWEL	11-6
B500WEL	11-6
FS06406AMAS	11-5
FS4205AWEL	11-7
FS4205AWEL	11-7
FS4205AWELC	11-4
FS4205AWELC	11-4
FS5106AWEL	11-7
FS5106AWELC	11-4
FS5205AWEL	11-7
FS5205AWELC	11-4
FS5406AMAS	11-5
FS5406AWEL	11-7
FS5406AWELC	11-4
FS6206AMAS	11-5
FS6206AWEL	11-7
FS6206AWELC	11-4
FS6306AMAS	11-5
FS6306AWEL	11-7
FS6306AWELC	11-4
FS6406AMAS	11-5
FS6406AWEL	11-7
FS6406AWELC	11-4
MD3060PWEL	11-6
MD3060PWELC	11-3
MD3560PWEL	11-6

Filtration 12

1146384	12-63
1147590	12-63
114880005	12-33
12542374	12-16
1376481	12-65
1397764	12-66
1397765	12-66
1397766	12-64
1433649	12-65
1450184	12-64
1616361	12-64
1618385-C91	12-47
1618386-C92	12-47
1629393	12-66
1643070	12-66
1643072	12-66
1661755C91	12-44
1674320C3	12-43
1677004-C91	12-47
1681202C91	12-49
1686587	12-63
1691027-C1	12-57
1691121-C1	12-49
1693965-C91	12-46
1695528-C1	12-48
1699168	12-64
17237	12-60
1801089-C1	12-45
1808623-C1	12-46

1808896-C1	12-48
1809789-C1	12-45
1811391	12-64
1811953-C1	12-48
1813104-C91	12-58
1814562-C1	12-48
1819452-C1	12-48
1820358-C1	12-57
1820361-C1	12-45
1820479-C1	12-46
1822313-C1	12-44
1822588C1	12-46
1822627-C1	12-44
1822631-C91	12-45
1825314-C1	12-45
1825864-C92	12-46
1833121-C1	12-47
1833121-C1	12-59
1840752-C91	12-48
1842638-C91	12-45
1842639-C91	12-47
1842639-C91	12-48
1873910-C91	12-46
1878042-C91	12-46
1966993	12-16
1967009	12-14
1967744	12-11
198-6378	12-35
1R0739	12-16
1R0750	12-12
1R0751	12-13
1R0759	12-13
1R1807	12-17
1R1807	12-36
1R1808	12-17
2005895-C1	12-43
2022289-C1	12-43
229348	12-65
229348	12-66
23042062	12-51
23514654	12-16
23518526	12-13
23518527	12-13
23518668	12-16
24200796	12-25
24208576	12-29
24210956	12-25
25012015	12-12
2503221-C1	12-48
25121293	12-12
25171792	12-13
25937966	12-50
279294C91	12-48
279294C92	12-48
29510922	12-22
29537268	12-18
29537965	12-21
29538489	12-19
29539579	12-18
29540493	12-18
29540494	12-19
29540976	12-11
3300721	12-12
3313281	12-17

3318853	12-18
3406889	12-16
3532799-C1	12-44
3800394	12-15
3903202	12-14
3903640	12-13
3908615	12-16
3925274	12-16
3937144	12-16
3937736	12-17
3942470	12-14
3959612	12-12
3973686	12-17
3C3P7G186AF	12-19
3C3Z6731AA	12-17
3C3Z7A098AA	12-19
3C3Z9N184CA	12-13
4070801	12-14
420051-C1	12-43
4298501	12-11
4299582	12-15
4304827	12-62
4309159	12-16
472098-C1	12-43
476741-C1	12-43
482644-C1	12-43
482647-C91	12-56
4897833	12-64
4897898	12-66
4931691	12-63
4934845	12-12
4934845	12-12
4934879	12-14
4940647	12-12
4C2U9601AB	12-11
4R75-W	12-32
588213C1	12-43
595722-C91	12-49
596606-C1	12-51
598698C1	12-48
61100179	12-33
625627-C1	12-46
649425	12-64
672603-C2	12-45
672603-C3	12-46
674293-C91	12-57
6F578	12-52
6N7617	12-14
6R80	12-32
702255-C1	12-47
87782	12-11
88892858	12-25
88937527	12-11
88984215	12-17
89017524	12-17
97148270	12-16
97214983	12-17
98017645	12-13
9Y4528	12-12
A1621C	12-52
A2032C	12-52
ABPS3226FL01	12-35
AF987	12-43
AF987	12-17

BF6X9601A	12-31
F1AZ6731A	12-16
F1AZ6731A	12-16
F4TZ7A098A	12-20
F50Y9601A	12-11
F50Y9601A	12-11
F6AZ7A098A	12-20
F89Z9155A	12-13
FA1632	12-23
FA1634	12-23
FA1746	12-23
FA1746	12-33
FA1804	12-11
FD4604	12-13
FD4606	12-23
FF105D	12-45
FF5052	12-45
FF5488	12-13
FF5632	12-13
FF5636	12-13
FG872	12-34
FG986B	12-13
FL2016	12-18
FL820S	12-17
FS1000	12-41
FS1003	12-14
FS1022	12-16
FS1065	12-13
FS1205	12-47
FS1282	12-41
FS19579	12-16
FS19800	12-16
FSR81205	12-47
FT105	12-25
FT113	12-25
FT114	12-25
FT145	12-26
FT158	12-20
FT180	12-26
GF481	12-13
GF578	12-13
GF652	12-23
HF6162	12-49
LF3420	12-48
LF3970	12-16
LF634	12-49
LF9001	12-42
LF9009	12-16
LF9548	12-16
P532503	12-33
P532504	12-33
P532966	12-34
P544432	12-33
P607955	12-33
P607960	12-33
P67955	12-56
PF2232	12-17
PF46	12-24
PF48	12-17
R50418	12-35
R50419	12-35
R90-BB-02	12-14
R90P	12-14
R90S	12-14

R90T	12-14
RE509672	12-17
RE57394	12-18
S3225P	12-15
S3226T	12-35
S3230	12-14
T1808D	12-60
TP1298B	12-24
VML/S1414	12-37
VMLT1808D	12-37
WF2071	12-12
WF2072	12-44
WF2073	12-44
WF2074	12-45
WF2075	12-41
WF2101	12-45
WF2122	12-41

Fluids 13

005978851M0	13-10
210456-783	13-9
210456-873	13-9
210456-983	13-9
210456-985	13-9
221225-319	13-9
221225-361	13-9
221225-870	13-9
221225-953	13-9
222220-351	13-8
222220-448	13-8
222220-462	13-8
226502-448	13-9
226502-560	13-9
226502-721	13-9
226502-981	13-9
226502-990	13-9
226532-351	13-9
226532-981	13-9
226718-448	13-9
226718-981	13-9
235208-451	13-11
235208-642	13-11
235208-643	13-11
235208-873	13-11
235208-980	13-11
43705030	13-10
43705045	13-10
500004741	13-8
5067708	13-11
5067715	13-11
5070736	13-10
5070739	13-10
550019913	13-8
550019916	13-8
550019918	13-8
550022332	13-12
550022333	13-10
550022334	13-12
550022334	13-12
550022522	13-7
9401000055	13-7

9401006021.....	13-7	176566ZN47.....	14-5	176568ZN94.....	14-10
9404206021.....	13-7	176566ZN48.....	14-5	176568ZR45.....	14-10
9406706021.....	13-7	176566ZN94.....	14-5	176568ZR47.....	14-10
98HF28.....	13-10	176566ZR45.....	14-5	176568ZR48.....	14-11
98HF29.....	13-10	176566ZR47.....	14-5	176568ZR94.....	14-11
98HF30.....	13-10	176566ZR48.....	14-5	176569DA84.....	14-13
98KH08.....	13-10	176566ZR94.....	14-5	176569DA85.....	14-13
CB0025.....	13-4	176567DA84.....	14-7	176569DA86.....	14-13
CB0550.....	13-4	176567DA85.....	14-7	176569DA87.....	14-13
CB2750.....	13-4	176567DA86.....	14-7	176569DN84.....	14-12
CB3300.....	13-4	176567DA87.....	14-7	176569DN85.....	14-12
CC3101.....	13-5	176567DN84.....	14-6	176569DN86.....	14-12
CC3155.....	13-5	176567DN85.....	14-6	176569DN87.....	14-12
CC7101.....	13-6	176567DN86.....	14-6	176569DR84.....	14-12
CC7155.....	13-6	176567DN87.....	14-6	176569DR85.....	14-12
DE1.....	13-13	176567DR84.....	14-7	176569DR86.....	14-12
EC3101.....	13-5	176567DR85.....	14-7	176569DR87.....	14-12
EC3155.....	13-5	176567DR86.....	14-7	176569FN31.....	14-12
EC3501.....	13-5	176567DR87.....	14-7	176569FN35.....	14-12
EC3555.....	13-5	176567FA31.....	14-7	176569ZA45.....	14-12
EC7101.....	13-6	176567FA32.....	14-7	176569ZA47.....	14-12
EC7155.....	13-6	176567FA33.....	14-8	176569ZA48.....	14-12
EC7501.....	13-6	176567FA35.....	14-8	176569ZA94.....	14-12
EC7555.....	13-6	176567FN31.....	14-6	176569ZN45.....	14-11
HC3101.....	13-5	176567FN32.....	14-6	176569ZN47.....	14-11
HC3155.....	13-5	176567FN33.....	14-7	176569ZN48.....	14-11
HC3501.....	13-5	176567ZA45.....	14-7	176569ZN94.....	14-11
HC3555.....	13-5	176567ZA47.....	14-7	176569ZR45.....	14-12
HC7101.....	13-6	176567ZA48.....	14-7	176569ZR47.....	14-12
HC7155.....	13-6	176567ZA87.....	14-7	176569ZR48.....	14-12
HC7501.....	13-6	176567ZA94.....	14-7	176569ZR94.....	14-12
HC7555.....	13-6	176567ZN47.....	14-6	180127DA84.....	14-9
M506RSS.....	13-13	176567ZN48.....	14-6	180127DA85.....	14-9
M516.....	13-13	176567ZN94.....	14-6	180127DA86.....	14-9
		176567ZR45.....	14-7	180127DA87.....	14-9
		176567ZR47.....	14-7	180127DN84.....	14-8
		176567ZR48.....	14-7	180127DN85.....	14-8
		176567ZR87.....	14-7	180127DN86.....	14-8
		176567ZR94.....	14-7	180127DN87.....	14-8
		176568DA84.....	14-11	180127DR84.....	14-9
		176568DA85.....	14-11	180127DR85.....	14-8
		176568DA86.....	14-11	180127DR86.....	14-8
		176568DA87.....	14-11	180127DR87.....	14-8
		176568DA87.....	14-10	180127ZA45.....	14-9
		176568DN84.....	14-10	180127ZA47.....	14-9
		176568DN85.....	14-10	180127ZA48.....	14-9
		176568DN86.....	14-10	180127ZA94.....	14-9
		176568DN87.....	14-10	180127ZN369.....	14-8
		176568DR84.....	14-11	180127ZN45.....	14-8
		176568DR85.....	14-11	180127ZN47.....	14-8
		176568DR86.....	14-11	180127ZN48.....	14-8
		176568DR87.....	14-11	180127ZN94.....	14-8
		176568FA31.....	14-11	180127ZR45.....	14-8
		176568FA33.....	14-11	180127ZR47.....	14-8
		176568FA35.....	14-11	180127ZR48.....	14-8
		176568FN31.....	14-10	180127ZR94.....	14-8
		176568FN33.....	14-10	180128DA84.....	14-14
		176568FN35.....	14-10	180128DA85.....	14-14
		176568FR31.....	14-11	180128DA86.....	14-14
		176568FR35.....	14-11	180128DA87.....	14-14
		176568ZA45.....	14-11	180128DA87.....	14-14
		176568ZA47.....	14-11	180128DA85.....	14-14
		176568ZA48.....	14-11	180128DA86.....	14-14
		176568ZA94.....	14-11	180128DA87.....	14-14
		176568ZN45.....	14-10	180128DN84.....	14-14
		176568ZN47.....	14-10	180128DN85.....	14-14
		176568ZN48.....	14-10	180128DN86.....	14-13
				180128DN87.....	14-13

Seats**14**

176566DA84.....	14-6
176566DA85.....	14-6
176566DA86.....	14-6
176566DA87.....	14-6
176566DN85.....	14-5
176566DN86.....	14-5
176566DN87.....	14-5
176566DR84.....	14-6
176566DR85.....	14-6
176566DR86.....	14-5
176566DR87.....	14-5
176566FA31.....	14-6
176566FA33.....	14-6
176566FA35.....	14-6
176566FN31.....	14-5
176566FN33.....	14-5
176566FN35.....	14-5
176566FR31.....	14-6
176566FR33.....	14-6
176566FR35.....	14-6
176566ZA45.....	14-6
176566ZA47.....	14-6
176566ZA48.....	14-6
176566ZA94.....	14-6
176566ZN45.....	14-5

180128DR84.....	14-14	4887JB.....	15-6	BA28600.....	15-23
180128DR85.....	14-14	4890JB.....	15-6	BA28650.....	15-23
180128DR86.....	14-14	4939AAH.....	15-6	BA28700.....	15-23
180128DR87.....	14-14	4939PGH.....	15-6	BA28850.....	15-23
180128YN370.....	14-13	4940PA.....	15-6	BA28900.....	15-23
180128YN371.....	14-13	4942PA.....	15-6	BA28950.....	15-23
180128YN372.....	14-13	4943PGH.....	15-6	BA29050.....	15-21
180128YN373.....	14-13	4944PA.....	15-6	BA29100.....	15-21
180128YN374.....	14-13	4945AAH.....	15-6	BA29150.....	15-21
180128YN380.....	14-13	4947PA.....	15-6	BA29200.....	15-21
180128YN381.....	14-13	4949PA.....	15-6	BA30200.....	15-24
180128YN382.....	14-13	4951PGH.....	15-6	BA30250.....	15-24
180128YN383.....	14-13	4958PA.....	15-6	BA30300.....	15-24
180128YN384.....	14-13	4959PA.....	15-6	BA30400.....	15-24
180128ZA45.....	14-14	4962PA.....	15-6	BA30450.....	15-24
180128ZA47.....	14-14	8200005.....	15-7	BA30500.....	15-24
180128ZA48.....	14-14	8200007.....	15-7	BA30550.....	15-24
180128ZA94.....	14-14	8200075.....	15-7	BA30600.....	15-24
180128ZN369.....	14-13	8200076.....	15-7	BA30650.....	15-24
180128ZN45.....	14-13	8200103.....	15-7	BA30700.....	15-24
180128ZN47.....	14-13	8200196.....	15-7	BA31000.....	15-21
180128ZN48.....	14-13	8200433.....	15-7	BA31100.....	15-21
180128ZN94.....	14-13	8600094.....	15-5	BA31D81.....	15-11
180128ZR45.....	14-14	8600223.....	15-5	BA31S121.....	15-11
180128ZR47.....	14-14	8600279.....	15-5	BA31S92.....	15-11
180128ZR48.....	14-14	8600280.....	15-5	BA32150.....	15-24
180128ZR94.....	14-14	8600298.....	15-5	BA33500.....	15-25
181704XN1161.....	14-15	8600299.....	15-5	BA33550.....	15-25
181704XN1162.....	14-15	8600300.....	15-5	BA33600.....	15-25
181704XN1163.....	14-15	8600307.....	15-5	BA33650.....	15-25
181704XN1165.....	14-15	8600308.....	15-5	BA33750.....	15-25
98BC-S72MH-T31.....	14-4	8600311.....	15-5	BA34200.....	15-25
98BC-S72MH-T32.....	14-4	8600312.....	15-5	BA34250.....	15-25
98BC-S72MH-T33.....	14-4	8600313.....	15-5	BA34300.....	15-25
98BC-S82MH-T31.....	14-4	8600314.....	15-5	BA34350.....	15-25
98BC-S82MH-T32.....	14-4	8600315.....	15-5	BA34600.....	15-25
98BC-S82MH-T33.....	14-4	8600316.....	15-5	BA34800.....	15-25
98BS-S72MH-T31.....	14-4	8600338.....	15-5	BA34850.....	15-25
98BS-S72MH-T32.....	14-4	8600339.....	15-5	BA34950.....	15-25
98BS-S72MH-T33.....	14-4	8600390.....	15-5	BA40050.....	15-21
98BS-S82MH-T31.....	14-4	AV1160J2008.....	15-6	BA40100.....	15-21
98BS-S82MH-T32.....	14-4	AV1160P2003.....	15-6	BA40150.....	15-21
98BS-S82MH-T33.....	14-4	AV1160P2007.....	15-6	BA40200.....	15-21
		BA11800.....	15-25	BA40250.....	15-21
		BA13250.....	15-25	BA40300.....	15-21
		BA21050.....	15-21	BA50250.....	15-21
		BA24050.....	15-22	BC1004.....	15-14
		BA25400.....	15-22	BC1030.....	15-14
		BA26550.....	15-22	BC1200.....	15-13
		BA26600.....	15-22	BC1203.....	15-13
		BA26650.....	15-22	BC1205.....	15-13
		BA26700.....	15-22	BC1206.....	15-13
		BA26750.....	15-22	BC1207.....	15-14
		BA26850.....	15-22	BC12821.....	15-20
		BA26900.....	15-22	BC1501.....	15-14
		BA28000.....	15-23	BC1507.....	15-14
		BA28050.....	15-23	BC1601.....	15-15
		BA28100.....	15-23	BC1602.....	15-15
		BA28150.....	15-23	BC1604.....	15-15
		BA28350.....	15-23	BC1611.....	15-20
		BA28400.....	15-23	BC1644.....	15-15
		BA28450.....	15-23	BC1727.....	15-20
		BA28550.....	15-23	BC2000.....	15-13
				BC2002.....	15-13

Electrical**15**

19011400.....	15-7
19011407.....	15-7
1N1378.....	15-9
2800LC.....	15-6
35259830S.....	15-8
35259840S.....	15-8
35262430.....	15-8
4833LGH.....	15-6
4836AAH.....	15-6
4836LGH.....	15-6
4846AAH.....	15-6
4860JB.....	15-6
4863JB.....	15-6
4867JB.....	15-6
4870JB.....	15-6
4885JB.....	15-6

BC2003.....	15-13	CB12850.....	15-38	CC30500.....	15-37
BC2004.....	15-13	CB12900.....	15-38	CC30600.....	15-37
BC2005.....	15-13	CB13500.....	15-38	CC30700.....	15-37
BC2006.....	15-13	CB13550.....	15-38	CC30800.....	15-37
BC2009.....	15-13	CB13600.....	15-38	CC30900.....	15-37
BC2012.....	15-13	CB13650.....	15-38	CC31050.....	15-37
BC2013.....	15-13	CC11050.....	15-35	CC31200.....	15-37
BC2015.....	15-13	CC11080.....	15-35	CC31350.....	15-37
BC2016.....	15-13	CC11100.....	15-35	CC31500.....	15-37
BC2017.....	15-13	CC11150.....	15-35	CC32100.....	15-37
BC2018.....	15-13	CC1120PLE0.....	15-35	CC32150.....	15-37
BC2021.....	15-13	CC11250.....	15-35	CC32200.....	15-37
BC3048.....	15-13	CC11300.....	15-35	CC32300.....	15-37
BC3096.....	15-13	CC12050.....	15-35	CC32350.....	15-37
BC4048.....	15-13	CC12080.....	15-35	CC33150.....	15-37
BC4096.....	15-13	CC12100.....	15-35	CC33200.....	15-37
BC6911.....	15-18	CC12150.....	15-35	CC33250.....	15-37
BC6924.....	15-18	CC12250.....	15-35	CC33300.....	15-37
BD31S62.....	15-11	CC12300.....	15-35	CC33350.....	15-37
BE10350.....	15-25	CC13050.....	15-35	CC33400.....	15-37
BL10050.....	15-39	CC13080.....	15-35	CM11200.....	15-55
BL10150.....	15-47	CC13100.....	15-35	CM11250.....	15-55
BL10200.....	15-47	CC13150.....	15-35	CM11300.....	15-55
BL10250.....	15-39	CC13200.....	15-35	CM11350.....	15-55
BL10300.....	15-39	CC13250.....	15-35	CM11400.....	15-55
BL10350.....	15-39	CC13300.....	15-35	CN10050.....	15-26
BL10400.....	15-39	CC13350.....	15-35	CN10100.....	15-26
BL10450.....	15-39	CC13400.....	15-35	CN10150.....	15-26
BL10500.....	15-39	CC14200.....	15-35	CN10250.....	15-26
BL10550.....	15-39	CC14250.....	15-35	CN10300.....	15-26
BL10600.....	15-39	CC14300.....	15-35	CN10350.....	15-26
BL10650.....	15-39	CC14350.....	15-35	CN10400.....	15-26
BL10700.....	15-39	CC14400.....	15-35	CN10450.....	15-26
BL10750.....	15-39	CC14500.....	15-35	CN10500.....	15-26
BL10800.....	15-39	CC15100.....	15-34	CN10550.....	15-26
BL10850.....	15-33	CC15150.....	15-34	CN10600.....	15-26
BL10950.....	15-39	CC15200.....	15-34	CN10650.....	15-27
BL1100.....	15-21	CC15250.....	15-34	CN10700.....	15-27
BL11150.....	15-39	CC15300.....	15-34	CN10750.....	15-27
BT31D61.....	15-11	CC22050.....	15-36	CN10800.....	15-27
BT31P111.....	15-11	CC22080.....	15-36	CN10850.....	15-27
BT31P61.....	15-11	CC22100.....	15-36	CN10900.....	15-27
BT31P71.....	15-11	CC22150.....	15-36	CN10950.....	15-27
BT31P75.....	15-12	CC22200.....	15-36	CN11000.....	15-27
BT31P91.....	15-11	CC22250.....	15-36	CN11100.....	15-27
BT31P95.....	15-12	CC22300.....	15-36	CN11150.....	15-27
BT31S111.....	15-11	CC22400.....	15-36	CN11200.....	15-27
BT31S61.....	15-11	CC23050.....	15-36	CN11250.....	15-27
BT31S71.....	15-11	CC23080.....	15-36	CN11300.....	15-27
BT31S72.....	15-11	CC23100.....	15-36	CN11350.....	15-27
BT31S75.....	15-12	CC23150.....	15-36	CN11400.....	15-28
BT31S91.....	15-11	CC23200.....	15-36	CN11450.....	15-28
BT31S95.....	15-12	CC23250.....	15-36	CN11500.....	15-28
CB12050.....	15-40	CC23300.....	15-36	CN11550.....	15-28
CB12100.....	15-38	CC23400.....	15-36	CN11600.....	15-28
CB12150.....	15-40	CC24100.....	15-36	CN11650.....	15-28
CB12200.....	15-38	CC24150.....	15-36	CN11700.....	15-28
CB12250.....	15-38	CC24200.....	15-36	CN11750.....	15-28
CB12300.....	15-38	CC24250.....	15-36	CN11800.....	15-28
CB12450.....	15-38	CC24300.....	15-36	CN11850.....	15-28
CB12650.....	15-38	CC24400.....	15-36	CN11900.....	15-28
CB12700.....	15-40	CC30350.....	15-37	CN11950.....	15-29
CB12750.....	15-38	CC30400.....	15-37	CN12000.....	15-29
CB12800.....	15-38	CC30450.....	15-37	CN12050.....	15-29

CN12150.....	15-29	CN20800.....	15-44	CN25300.....	15-45
CN12250.....	15-29	CN20900.....	15-44	CN25320.....	15-45
CN12300.....	15-33	CN20950.....	15-43	CN25330.....	15-45
CN12350.....	15-29	CN21000.....	15-43	CN25350.....	15-45
CN12400.....	15-29	CN21050.....	15-43	CN25400.....	15-45
CN12450.....	15-30	CN21100.....	15-43	CN25450.....	15-45
CN12500.....	15-30	CN21150.....	15-44	CN25460.....	15-45
CN12550.....	15-30	CN21160.....	15-44	CN25470.....	15-45
CN12600.....	15-31	CN21180.....	15-44	CN25500.....	15-45
CN12650.....	15-30	CN21210.....	15-44	CN25550.....	15-45
CN12700.....	15-30	CN22050.....	15-46	CN25600.....	15-45
CN12750.....	15-31	CN22150.....	15-46	CN25650.....	15-43
CN12800.....	15-31	CN22200.....	15-46	CN26030.....	15-42
CN12900.....	15-31	CN22300.....	15-46	CN26050.....	15-42
CN12950.....	15-31	CN22350.....	15-46	CN26100.....	15-42
CN13000.....	15-31	CN22550.....	15-46	CN26150.....	15-42
CN13050.....	15-31	CN22600.....	15-46	CN26160.....	15-41
CN13100.....	15-31	CN22650.....	15-46	CN26200.....	15-41
CN13200.....	15-31	CN22700.....	15-46	CN26250.....	15-41
CN13250.....	15-31	CN22800.....	15-46	CN26300.....	15-41
CN13300.....	15-33	CN22850.....	15-46	CN26350.....	15-41
CN13350.....	15-31	CN22900.....	15-46	CN26400.....	15-41
CN13400.....	15-32	CN22950.....	15-46	CN26410.....	15-41
CN13500.....	15-32	CN23000.....	15-46	CN26450.....	15-42
CN13550.....	15-32	CN23100.....	15-46	CN26500.....	15-42
CN13600.....	15-32	CN23150.....	15-46	CN26550.....	15-42
CN13650.....	15-32	CN23200.....	15-46	CN26600.....	15-42
CN13700.....	15-32	CN23250.....	15-46	CN26650.....	15-42
CN13750.....	15-32	CN23300.....	15-46	CN26700.....	15-42
CN13800.....	15-32	CN23350.....	15-46	CN26750.....	15-42
CN13850.....	15-33	CN23400.....	15-46	CN26800.....	15-42
CN13900.....	15-33	CN23450.....	15-46	CN26900.....	15-42
CN13950.....	15-32	CN23500.....	15-46	CN26950.....	15-42
CN14000.....	15-32	CN23550.....	15-46	CN26960.....	15-42
CN14050.....	15-32	CN23850.....	15-46	CN27000.....	15-42
CN14150.....	15-32	CN24050.....	15-44	CN27050.....	15-42
CN14300.....	15-33	CN24100.....	15-44	CN27100.....	15-42
CN14350.....	15-33	CN24150.....	15-44	CN27150.....	15-42
CN14400.....	15-33	CN24200.....	15-44	CN27200.....	15-42
CN14450.....	15-33	CN24250.....	15-44	CN27250.....	15-42
CN14500.....	15-33	CN24300.....	15-45	CN27300.....	15-42
CN14550.....	15-33	CN24350.....	15-45	CN27350.....	15-42
CN14600.....	15-33	CN24400.....	15-45	CN27400.....	15-42
CN14650.....	15-33	CN24450.....	15-45	CN27430.....	15-42
CN14750.....	15-33	CN24500.....	15-45	CN27450.....	15-42
CN14800.....	15-33	CN24550.....	15-45	CN27500.....	15-42
CN14850.....	15-33	CN24560.....	15-45	CN27550.....	15-42
CN14900.....	15-46	CN24600.....	15-45	CN27570.....	15-42
CN15050.....	15-32	CN24610.....	15-45	CN27600.....	15-42
CN15150.....	15-49	CN24650.....	15-45	CN27650.....	15-42
CN15200.....	15-49	CN24660.....	15-45	CN27700.....	15-42
CN15400.....	15-32	CN24670.....	15-45	CN27750.....	15-42
CN15450.....	15-47	CN24680.....	15-45	CN27760.....	15-42
CN15500.....	15-33	CN24700.....	15-45	CN27800.....	15-42
CN20050.....	15-44	CN24750.....	15-45	CN27810.....	15-42
CN20150.....	15-44	CN24800.....	15-45	CN27850.....	15-42
CN20200.....	15-44	CN24810.....	15-45	CN27900.....	15-42
CN20250.....	15-43	CN25050.....	15-44	CN27950.....	15-42
CN20300.....	15-43	CN25100.....	15-45	CN28000.....	15-42
CN20350.....	15-43	CN25150.....	15-45	CN28050.....	15-42
CN20450.....	15-43	CN25200.....	15-45	CN28100.....	15-42
CN20600.....	15-43	CN25210.....	15-45	CN28150.....	15-42
CN20700.....	15-44	CN25250.....	15-45	CN28210.....	15-43
CN20750.....	15-44	CN25260.....	15-45	CN28220.....	15-43

CN29050	15-43	CN50500	15-47	CTS2513	15-50
CN29100	15-43	CN50550	15-47	CTS2514	15-50
CN29150	15-43	CN50600	15-47	CTS2715	15-50
CN29200	15-43	CN50650	15-47	CTS2716	15-50
CN29250	15-43	CN50700	15-47	CTS5513	15-50
CN29300	15-43	CN50800	15-47	CTS5514	15-50
CN29350	15-43	CN50900	15-47	CTS5715	15-50
CN29400	15-43	CN50950	15-47	CTS5716	15-50
CN29450	15-43	CN60050	15-33	CTS6514	15-50
CN29500	15-43	CN60100	15-33	CTS6515	15-50
CN29520	15-43	CN60400	15-55	CTS6716	15-50
CN29550	15-43	CN60450	15-46	CTS6717	15-50
CN29650	15-43	CN60500	15-39	CTS7511	15-50
CN29700	15-43	CN60900	15-33	CTS7513	15-50
CN29750	15-43	CN61250	15-49	CTS7712	15-50
CN29800	15-43	CN61300	15-49	CTS7714	15-50
CN29850	15-43	CT01111	15-51	CTS8416	15-50
CN29900	15-43	CT01112	15-51	CTS8513	15-50
CN29950	15-43	CT01114	15-51	CTS8514	15-50
CN29960	15-43	CT01115	15-51	CTS8715	15-50
CN29970	15-43	CT01116	15-51	D6011-1336	15-19
CN29980	15-43	CT01117	15-51	FR10080	15-21
CN29990	15-43	CT03111	15-51	HT2108C0	15-48
CN30100	15-46	CT03112	15-51	HT21100	15-48
CN30150	15-46	CT03316	15-51	HT2110C0	15-48
CN30250	15-46	CT03317	15-51	HT21140	15-48
CN30400	15-46	CT03517	15-51	HT2114C0	15-48
CN30500	15-46	CT03718	15-51	HT21180	15-48
CN30550	15-46	CT04311	15-51	HT2118C0	15-48
CN30650	15-46	CT04312	15-51	M105312	15-8
CN40050	15-47	CT04313	15-51	M105602	15-8
CN40100	15-47	CT05317	15-51	M105611	15-8
CN40150	15-47	CT05318	15-51	M105612	15-8
CN40200	15-48	CT05512	15-51	M105613	15-8
CN40250	15-47	CT05513	15-51	MC2378	15-9
CN40300	15-47	CT06518	15-51	MC2378	15-9
CN40350	15-47	CT06519	15-51	MS1310	15-20
CN40400	15-48	CT06712	15-51	MS1338	15-19
CN40450	15-48	CT08512	15-51	MS1519	15-19
CN40500	15-48	CT09512	15-51	MS1522	15-19
CN40550	15-48	CT09711	15-51	MS1525	15-19
CN40600	15-48	CT10050	15-54	MS1528	15-19
CN40650	15-48	CT10200	15-55	MS1531	15-19
CN40700	15-48	CT10250	15-55	MS1534	15-19
CN40750	15-48	CT10350	15-55	MS1551	15-19
CN40800	15-48	CT3312M0	15-53	MS1554	15-19
CN40850	15-49	CTB3520	15-52	MS1557	15-18
CN40900	15-49	CTB5518	15-52	MS1561	15-18
CN40950	15-49	CTB5519	15-52	MS1564	15-18
CN41000	15-49	CTD6511	15-53	MS1567	15-18
CN41050	15-47	CTM2111	15-53	MS1587	15-15
CN41100	15-47	CTM2112	15-53	MS1671	15-19
CN41150	15-48	CTM2212	15-53	MS1674	15-19
CN41200	15-48	CTM2213	15-53	MS1677	15-19
CN42700	15-49	CTM3313	15-53	MS1680	15-19
CN42900	15-49	CTM3314	15-53	MS1683	15-18
CN43050	15-46	CTM5512	15-53	MS1685	15-18
CN43100	15-46	CTM5513	15-53	MS2010	15-13
CN50100	15-47	CTM5520	15-53	MS2022	15-13
CN50150	15-47	CTM6311	15-53	PV2479	15-9
CN50200	15-47	CTM6312	15-53	RT10050	15-54
CN50250	15-47	CTR3719	15-53	RT10100	15-54
CN50300	15-47	CTS1512	15-50	RT10150	15-54
CN50450	15-47	CTS1513	15-50	RT10200	15-54

TM1527	15-16
TM1530	15-16
TM1531	15-16
TM1532	15-16
TM1533	15-16
TM1536	15-16
TM1539	15-17
TM1542	15-17
TM1545	15-17
TM1548	15-17
TM1575	15-14
TM1578	15-14
TM1579	15-14
TM1580	15-14
TM1581	15-14
TM1582	15-15
TM1583	15-14
TM1584	15-14
TM1585	15-15
TM1586	15-15
TM1588	15-15
TM1589	15-15
TM1590	15-15
TM1591	15-15
TM1592	15-15
TM1593	15-15
TM1595	15-15
TM1596	15-15
TM1598	15-15
TM1599	15-15
TM1600	15-15
TM1623	15-14
TM1626	15-14
TM1629	15-14
TM1632	15-14
TM1635	15-14
TM1638	15-14
TM1641	15-15
TM1647	15-16
TM1650	15-16
TM1653	15-16
TM1655	15-16
TM1656	15-16
TM1662	15-16
TM1696	15-17
TM1699	15-17
VT2108C0	15-48
VT21100	15-48
VT2110C0	15-48
VT21140	15-48
VT2114C0	15-48
VT21180	15-48
VT2118C0	15-48
VT8100C0	15-49
VT81010	15-49
VT8101C0	15-49

Audio/Video 16

DV115 16-8	
FM100	16-6
H00755NS	16-7

H00910CA	16-7	00852-2301B	17-17
L24	16-6	00852-23-250B	17-17
PAN5PM	16-4	00852-23-940B	17-17
PP102629	16-3	00853-93-701B	17-6
PP102815	16-3	00856-33-240B	17-15
PP103143	16-3	00856-3360B	17-15
PP103144	16-3	00931-0301	17-23
PP103222	16-3	03081-00B	17-19
PP103223	16-3	03085-00B	17-19
PP103341	16-3	03086-00B	17-19
PP103347	16-4	03181-00B	17-19
PP104190	16-4	03183-00B	17-19
PP104191	16-3	03186-00B	17-19
PP104341	16-3	03211-00B	17-20
PP104342	16-3	03286-00B	17-20
PP104343	16-3	03421-00B	17-20
PP301424	16-7	03581-00B	17-20
PP302971	16-7	03586-00B	17-20
PP303142	16-6	03591-00B	17-20
PP603098	16-5	03596-061	17-20
PP603102	16-5	03601-011B	17-20
PP603104	16-5	03606-061B	17-20
PP603146	16-5	03611-00B	17-20
PPC00185	16-6	03681-00B	17-20
RAD4120	16-6	03686-00B	17-20
STSK5465	16-8	06441-00B	17-20
STSK7465	16-8	0744-21-240B	17-16
		08451-00B	17-20
		08456-00B	17-20
		10695-055	17-22
		199N1860	1-73
		37879-00B	17-24
		410-4112041	17-24
		420-3020411	17-24
		42224-00B	17-20
		4241APRO	17-5
		4241C	17-5
		4242A	17-5
		4242C	17-5
		4261A	17-5
		4261C	17-5
		4262APRO	17-5
		4262C	17-5
		427-3026221	17-24
		427-4095211	17-24
		430-3012111	17-24
		447-3022151	17-24
		45883-00B	17-24
		46014-00B	17-20
		46120-00B	17-20
		499-1011901	17-24
		499-1011911	17-24
		499-3014591	17-24
		499-3014621	17-24
		499-301462NB	17-24
		499-3054741	17-24
		499-3154211	17-24
		499-4113301	17-23
		499-4113311	17-23
		499-4114301	17-23
		499-4130101	17-23
		499-4130111	17-23
		499-4130201	17-23
		499-4130211	17-23

Lighting 17

00200-2601B	17-12
00319-0100B	17-18
00319-0600B	17-18
00326-1100B	17-18
00333-1600B	17-18
00500-01-637B	17-13
00529-1319B	17-14
00529-13-240B	17-14
00529-1344B	17-14
00541-1603B	17-13
00543-53-602B	17-6
00555-9101B	17-13
00555-9155B	17-10
00555-9169B	17-13
00555-9601B	17-13
00555-9655B	17-10
00555-9669B	17-13
00556-9101B	17-13
00556-9601B	17-13
00563-01-535B	17-9
00596-00-047B	17-14
00596-00-048B	17-14
00744-21-245B	17-16
00744-2165B	17-15
00744-2501B	17-17
00744-25-240B	17-17
00744-2655B	17-16
00744-91-010B	17-12
00810-23411	17-21
00845-21-241B	17-21
00845-26-240B	17-21
00845-26-241B	17-21

FA0-134PAC.....	21-7
FA0-320PAC.....	21-8
MD1005K.....	21-14
P0AC10000.....	21-15
P0AC1037B.....	21-15
P0AC5047B.....	21-15
P0AC9054.....	21-15
P0AC9603.....	21-15
PP803978.....	21-16
PP803980.....	21-16
PP804146.....	21-16
PP804148.....	21-16
V82-1541-010150.....	21-5
V82-4441-010150.....	21-4
V82-4441-020150.....	21-5
V92-4441-010150.....	21-4
V92-4441-020150.....	21-5
V99-4441-020150.....	21-5

SUBJECT INDEX

A

Air Systems

ABS Cables.....	8-5
ABS Sensors.....	8-6
Air Brake Hardware.....	8-7
Air Brake Hose.....	8-11
Air Compressors.....	8-17
Air Dryers.....	8-12
Air Governors.....	8-19
Brake Valves.....	8-21
Brake Valves Actuators.....	8-24
Brake Valves Packages.....	8-25
Check Valves- Single.....	8-26
Check Valves - Double.....	8-27
Control Valves.....	8-28
Modulating Valves.....	8-30
Pressure Protection Valves....	8-31
Quick Release Valves.....	8-33
Relay Valves.....	8-36
Safety Valves.....	8-40
Spring Brake Valves.....	8-41
Switches.....	8-43
Troubleshooting Tips.....	8-15

Audio & Video

Antennas & Speakers.....	16-6
Cameras.....	16-8
Radio/CD Players.....	16-3
Microphones.....	16-4
Panels.....	16-5
Horns.....	16-7

B

Brakes

Brake Drums.....	1-48
Brake Hardware.....	1-37
Brakes Hydraulic.....	1-106
Brake Hydraulic Lines & Fittings.....	1-33
Brake Calipers.....	1-119
Brake Rotors.....	1-125
Brake Chambers.....	1-136
Brake Pads.....	1-9
Brake S-Cams.....	1-69
Brake Shoes.....	1-27
Brake Slack Adjusters.....	1-50

C

Cold Weather

Coolant Heaters.....	10-3
Immersion Block Heaters.....	10-5

D

Drivetrain

Center Bearings.....	4-6
U-Joint Parts & Kits.....	4-3

E

Electrical

Alternators.....	15-5
Batteries (Excludes Mexico).....	15-11
Batteries (Mexico Only).....	15-12
Battery Cables.....	15-13
Cable Ties.....	15-50
Circuit Breakers, Fuses, & Relays.....	15-34
Connectors.....	15-26
Flashers.....	15-40
Starters.....	15-7
Switches.....	15-21
Tools.....	15-54
Wire Connectors.....	15-41

Engines

Charge Air Coolers.....	7-12
Fan Drives.....	7-14
Engine Kits.....	7-24
Fans.....	7-19
Radiators.....	7-6

Emissions

DOC & DPF Products.....	9-3
Exhaust Products.....	9-7

F

Filtration

BlueBird.....	12-11
Collins.....	12-23
Corbeil.....	12-27
Ford.....	12-31
Freightliner.....	12-33
Gillig.....	12-41
International/IC Bus.....	12-43

Mid Bus.....	12-52
Thomas Built.....	12-56
Van Hool.....	12-63

Fluid

Axle/Gear Oil.....	13-12
Chassis Grease.....	13-11
CleanBlue® Diesel Exhaust Fluid.....	13-4
Engine Coolant.....	13-5
Engine Oil.....	13-8
Transmission Fluid.....	13-9
Wiper Fluid.....	13-13

G

Glass

Windshields.....	19-4
Wipers.....	19-3

H

HVAC

Blower Motors.....	18-8
Blower Wheels.....	18-13
Booster Pumps.....	18-14
Compressors.....	18-4
Defrost Fans.....	18-15
Filters.....	18-17
Heater Cores.....	18-16
Water Valves.....	18-18

L

Lighting

Halogen Lamps.....	17-21
Headlamp Bulbs.....	17-22
Headlamp Assemblies & Mounting Accessories.....	17-23
Incandescent Lamps.....	17-13
LED Lamps.....	17-6
Strobe Lamps.....	17-5

M

Mirrors.....	20-3
--------------	------

S**Safety**

Conspicuity Tape.....	21-4
Fire Extinguishers	21-13
First Aid Kits	21-6
Tire Chains.....	21-15
Tire Pressure Maintenance	
Systems	21-16
Triangle Kits	21-14
Permit Holders	21-14

Seats

Bus Driver Seats	14-4
Seat Covers	14-15

Steering

Drag Links.....	5-7
Steering Assembly Parts.....	5-6
Steering Gears & Pumps ...	5-4-5-5
Steering Hardware	5-11
Tie Rod Ends	5-8
TRP® King Pin Kits.....	5-9

Suspension

Air Springs	6-5
Height Control Valves	6-12
Shock Absorbers.....	6-13
Hendrickson Suspensions	6-52
Neway Suspensions	6-78
AS Service Rebuild Kits (SRKs).....	6-82

T**Transmissions**

Transmissions for Canada	11-3
Transmissions for U.S.....	11-6

U

Wheels	2-4
Wheels Hardware	2-6

TABLES

Brakes Tables

<u>Table 1-19:</u> 15" Eaton OE	<u>1-37</u>
<u>Table 1-21:</u> 15" Eaton for FMSI 4729	<u>1-37</u>
<u>Table 1-22:</u> 15" Eaton Steer Axle ES (Reduced Envelope)	<u>1-38</u>
<u>Table 1-20:</u> 15" Eaton Aftermarket	<u>1-37</u>
<u>Table 1-23:</u> 15" Eaton Drive Axle ES (Reduced Envelope)	<u>1-38</u>
<u>Table 1-24:</u> 15" Meritor Q - Overhaul	<u>1-39</u>
<u>Table 1-26:</u> 15" Meritor Q Offset Spider	<u>1-40</u>
<u>Table 1-27:</u> 15" Meritor Q Plus with TrackLok.	<u>1-40</u>
<u>Table 1-25:</u> 15" Meritor Q - Complete Overhaul	<u>1-39</u>
<u>Table 1-28:</u> 15" Meritor Q Plus - Front Steer Axle with Heavy Duty Spring	<u>1-40</u>
<u>Table 1-29:</u> 16-1/2" Eaton ES	<u>1-41</u>
<u>Table 1-33:</u> 16-1/2" Eaton ES - Drive Axle	<u>1-42</u>
<u>Table 1-34:</u> 16-1/2" Eaton ES - Drive Axle with Cast Brake Shoes - Complete Overhaul	<u>1-43</u>
<u>Table 1-35:</u> 16-1/2" Eaton ES - Drive Axle with Fabricated Brake Shoes - Complete Overhaul	<u>1-43</u>
<u>Table 1-32:</u> 16-1/2" Eaton - Drive Axle with High Mount Brake Shoes	<u>1-42</u>
<u>Table 1-30:</u> 16-1/2" Eaton with Fabricated Brake Shoes	<u>1-41</u>
<u>Table 1-31:</u> 16-1/2" Eaton with Heavy Duty Return Spring.	<u>1-41</u>
<u>Table 1-36:</u> 16-1/2" Eaton ES II - OE Front Axle.	<u>1-44</u>
<u>Table 1-41:</u> 16-1/2" Intraxx, Meritor Q, Q Plus and Spicer XLII AfterMarket.	<u>1-47</u>
<u>Table 1-42:</u> 16-1/2" Intraxx, Meritor Q, Q Plus and Spicer XLII AfterMarket with Heavy Duty Return Spring	<u>1-47</u>
<u>Table 1-37:</u> 16-1/2" Meritor Q - Complete Overhaul	<u>1-45</u>
<u>Table 1-38:</u> 16-1/2" Meritor Q with Heavy Duty Return Spring (kit without bushings)	<u>1-45</u>
<u>Table 1-40:</u> 16-1/2" Meritor Q - Front Steer Axle - Complete Overhaul (services clipped and hammerclaw cams).	<u>1-46</u>
<u>Table 1-39:</u> 16-1/2" Meritor Q - Front Steer Axle (services clipped and hammerclaw cams)	<u>1-46</u>

Table 1-70: Bendix Brake Rotors	1-127
Table 1-2: Bendix Inner and Outer Pads	1-11
Table 1-4: Bendix Universal Pads - Heavy Duty	1-13
Table 1-3: Bendix Universal Pads - Premium Pads	1-12
Table 1-64: Bendix Hydraulic Brakes	1-113
Table 1-66: Bendix Hydraulic Calipers	1-119
Table 1-8: Brake Pads - Chevrolet	1-24
Table 1-7: Brake Pads - Blue Bird	1-24
Table 1-9: Brake Pads - Ford	1-24
Table 1-10: Brake Pads - International/IC Bus	1-24
Table 1-11: Brake Pads - Thomas Built	1-25
Table 1-71: Brake Rotors - AC Delco	1-132
Table 1-72: Brake Rotors - Bendix	1-132
Table 1-73: Brake Rotors - Bendix Formula Blue	1-132
Table 1-74: Brake Rotors - Bluebird	1-132
Table 1-76: Brake Rotors - Dayton	1-132
Table 1-77: Brake Rotors - Euclid	1-132
Table 1-78: Brake Rotors - Ford	1-132
Table 1-79: Brake Rotors - Freightliner/Thomas Built	1-132
Table 1-75: Brake Rotors - GM	1-132
Table 1-80: Brake Rotors - GM	1-132
Table 1-81: Brake Rotors - GMC	1-132
Table 1-82: Brake Rotors - Gunite	1-132
Table 1-83: Brake Rotors - International/IC Bus/Navistar Front and Rear Axles	1-132
Table 1-85: Brake Rotors - Webb	1-132
Table 1-62: Brake S-Cams Cross Reference	1-95
Table 1-46: Brake Slack Adjusters Cross Reference	1-65
Table 1-49: Bronze Bushing S-Cam Repair Kit for Bus Brakes	1-70
Table 1-6: Bus Applications for Performance Friction Brake Pads	1-18
Table 1-92: Cross Reference for Brake Chambers	1-137

Table 1-93: Cross Reference for Brake Drums	1-137
Table 1-47: Eaton Steering Axles with 15" single anchor pin brakes	1-69
Table 1-50: Eaton 15" S-Cam Brake Repair Kits	1-71
Table 1-52: Eaton 15", 16-1/2" and 18" S-Cam Brake Repair Kits	1-72
Table 1-51: Eaton 15" and 16-1/2" S-Cam Brake Repair Kits	1-71
Table 1-56: Eaton Drive Axles with 16-1/2" and 18" brakes	1-84
Table 1-57: Eaton Drive Axles with 16-1/2" ES (Extended Service) and 15" Reduced Envelope brakes	1-85
Table 1-48: Eaton Steering Axles with 15" ES (Extended Service) Brakes	1-70
Table 1-91: Haldex Brake Chambers	1-136
Table 1-13: HPB Master Cylinder Assembly	1-33
Table 1-65: Hydraulic Brakes From Meritor	1-117
Table 1-84: Meritor	1-132
Table 1-45: Meritor Automatic Slack Adjuster (stroke sensing) Repair Kits	1-54
Table 1-67: Meritor Hydraulic Calipers	1-120
Table 1-12: Meritor New Lined Brake Shoes & Brake Shoe Kits	1-26
Table 1-63: Meritor Hydraulic Brakes	1-111
Table 1-53: Meritor 15" and 16-1/2" - Q and Q Plus S-Cam Brake Repair Kits	1-72
Table 1-54: Meritor 16-1/2" - P, Q, Q Plus S-Cam Brake Repair Kits	1-73
Table 1-55: Meritor 16-1/2" Q Plus Long Life (LX500) S-Cam Brake Repair Kits	1-73
Table 1-5: Meritor Inner and Outer Pads	1-16
Table 1-60: Meritor "Q Plus" brakes	1-88
Table 1-61: Meritor "Q Plus" brakes with Traclock	1-94
Table 1-44: Meritor Slack Adjusters	1-50
Table 1-1: Meritor Universal Pads	1-9
Table 1-69: Performance Friction Brake Rotors	1-126
Table 1-86: Rotors (Bendix) - Blue Bird	1-133
Table 1-87: Rotors (Bendix) - Chevrolet	1-133
Table 1-88: Rotors (Bendix) - Ford	1-133
Table 1-89: Rotors (Bendix) - International/IC Bus	1-134

Table 1-15: Steel Brake Adapter Lines	1-35
Table 1-14: Steel Brake Lines	1-34
Table 1-16: Steel Brake Line Fittings	1-35
Table 1-17: Steel Brake Lines for Imported Vehicles	1-36
Table 1-18: Steel Brake Line Fittings for Imported Vehicles	1-36
Table 1-58: Transit applications with Meritor brakes	1-86
Table 1-59: Transit applications with Meritor brakes with Head End Snap Ring Groove	1-87
Table 1-90: TRP® Brake Chambers	1-136
Table 1-43: Webb® Brake Drums	1-48
Table 1-68: Webb Brake Rotors	1-125

Wheels & Wheel End Tables

Table 2-2: Aluminum Wheels from Accuride	2-5
Table 2-15: Back Nuts (Grade C)	2-15
Table 2-42: Brake Drum Hardware	2-31
Table 2-17: Cap Nuts for Single & Dual Mounted Wheels	2-15
Table 2-20: Cone Lock Nuts (2-Piece Flanged Nut)	2-17
Table 2-47: Cross Reference for Wheels	2-38
Table 2-23: Drive Axle Stud - Stud Body Diameter .975" For Aluminum Disc Wheels	2-19
Table 2-38: Drive Flange & General Purpose Studs - Grade 8	2-29
Table 2-40: Drive Flange Nuts	2-30
Table 2-37: Drive Flange Studs - Grade 8	2-28
Table 2-39: Drive Flange Wedges (Plated)	2-30
Table 2-41: Drum Bolt Assemblies	2-31
Table 2-19: Flanged Cap Nuts	2-16
Table 2-18: Flanged Cap Nuts for Single & Dual Mounted Wheels	2-16
Table 2-16: Flat Wheel Nuts	2-15
Table 2-22: Front Wheel Studs - Stud Body Diameter 1.220" for Aluminum Disc Wheels	2-18
Table 2-21: Front Wheel Studs - Stud Body Diameter 1.220"	2-17

Table 2-36: Metric Serrated Wheel Studs - Grade 10.9, M22x1.5 Thread	2-28
Table 2-30: Metric Serrated Wheel Studs - Stud Body Diameter .791" - M20x1.5-6G Thread	2-25
Table 2-31: Metric Serrated Wheel Studs - Stud Body Diameter .791" - M20x1.5 Thread	2-26
Table 2-32: Metric Serrated Wheel Studs - Stud Body Diameter .890"	2-26
Table 2-33: Metric Serrated Wheel Studs - Stud Body Diameter .901"	2-27
Table 2-34: Metric Serrated Wheel Studs - Stud Body Diameter .910"	2-27
Table 2-35: Metric Serrated Wheel Studs - Stud Body Diameter .975"	2-27
Table 2-46: Rim Clamps	2-33
Table 2-24: Serrated Wheel Studs - Grade 8 - 3/4" -16 Thread	2-19
Table 2-25: Serrated Wheel Studs - Stud Body Diameter .630"	2-22
Table 2-26: Serrated Wheel Studs - Stud Body Diameter .745"	2-22
Table 2-27: Serrated Wheel Studs - Stud Body Diameter .784"	2-22
Table 2-28: Serrated Wheel Studs with Drum Shoulder - Stud Body Diameter .784"	2-24
Table 2-29: Serrated Wheel Studs - Stud Body Diameter .974"	2-25
Table 2-43: Spoke Wheel & Rim Studs- Grade 8	2-31
Table 2-44: Spoke Wheel & Rim Studs- Grade 8 - Special Cases	2-32
Table 2-45: Spoke Wheel & Rim Bolts	2-32
Table 2-1: Steel Wheels from Accuride	2-4
Table 2-6: TRP® Assorted Wheel Nuts	2-7
Table 2-10: TRP® Disc Wheel Studs (Metric)	2-10
Table 2-12: TRP® Assorted Wheel Studs	2-11
Table 2-9: TRP® Disc Wheel Studs (SAE)	2-9
Table 2-3: TRP® Inner Wheel Nuts	2-6
Table 2-5: TRP® Outer Disc Wheel Nuts	2-7
Table 2-4: TRP® Outer Wheel Nuts	2-6
Table 2-8: TRP® Wheel Studs (Metric)	2-9
Table 2-7: TRP® Wheel Studs (SAE)	2-7
Table 2-11: TRP® Wheel Studs with Shoulder	2-10
Table 2-14: Wheel Hardware - Aluminum Wheels	2-14

Table 2-13: Wheel Hardware - Steel/Aluminum Wheels	2-13
--	----------------------

Drivetrain Tables

Table 4-10: Center Bearings - Type 2	4-6
Table 4-11: Cross Reference for Drivetrain	4-7
Table 4-9: Dana Center Bearing Assemblies	4-6
Table 4-7: Meritor Strap & Bolt Kits	4-5
Table 4-4: U-Joint Kits - Easy Service Full Rounds	4-4
Table 4-2: U-Joint Kits - Easy Service Half Rounds	4-3
Table 4-3: U-Joint Kits - Full Rounds	4-4
Table 4-1: U-Joint Kits - Half Rounds	4-3
Table 4-5: U-Joint Kits - Spicer SPL Series	4-4
Table 4-8: TRP® Center Bearing Assemblies	4-6
Table 4-6: TRP® Strap & Bolt Kits	4-5

Steering Tables

Table 5-5: Blue Bird Steering Assembly Components	5-6
Table 5-1: Blue Bird Steering Gears	5-4
Table 5-3: Blue Bird Steering Pumps	5-5
Table 5-6: Meritor Drag Links	5-7
Table 5-7: Meritor Tie Rod Ends	5-8
Table 5-14: Steering Cross Reference	5-16
Table 5-2: Steering Gears for Other Bus Makes	5-4
Table 5-4: Steering Pumps for Other Bus Makes	5-5
Table 5-9: Steering Spindle Hardware for Chevrolet & GMC Axles	5-11
Table 5-10: Steering Spindle Hardware for Ford Axles	5-11
Table 5-11: Steering Spindle Hardware for Mack Front Axles	5-12
Table 5-12: Steering Spindle Hardware for Meritor Axles	5-13
Table 5-13: Steering Spindle Hardware for Navistar Axles	5-15
Table 5-8: TRP® King Pin Kits for International	5-9

Suspension Tables

Table 6-2: Air Springs Cross Reference	6-11
Table 6-5: Blue Bird Shocks	6-13
Table 6-4: ABC Bus Shocks	6-13
Table 6-6: Bus & Truck Co. Shocks	6-17
Table 6-7: Carpenter Bus Shocks	6-17
Table 6-8: Chevrolet Truck Shocks	6-17
Table 6-9: Continental Trailways - Eagle International Shocks	6-22
Table 6-10: Dina Bus Shocks	6-22
Table 6-11: Dodge Truck Shocks	6-22
Table 6-12: Eagle Motor Coach Shocks	6-23
Table 6-13: Fixible Bus Shocks	6-23
Table 6-14: Ford Shocks	6-26
Table 6-15: Freightliner Shocks	6-27
Table 6-28: Optima Bus Corporation Shocks	6-42
Table 6-29: Orion Bus Industries Shocks	6-42
Table 6-16: Gillig LLC Shocks	6-28
Table 6-17: GMC Truck Shocks	6-28
Table 6-18: Greyhound Bus Shocks	6-32
Table 6-19: Grumman Bus Shocks	6-33
Table 6-3: Height Control Valve	6-12
Table 6-20: Highway Product Shocks	6-33
Table 6-21: International/ IC Bus Shocks	6-33
Table 6-23: MAECO Shocks	6-39
Table 6-22: M.A.N. Bus Shocks	6-38
Table 6-24: Matson School Bus Shocks	6-39
Table 6-25: MCI (Motor Coach Industries) Shocks	6-39
Table 6-26: NEOPLAN Bus Shocks	6-40
Table 6-45: Neway ASB Series – Service Rebuild Kits (SRKs)	6-83

Table 6-43: Neway ASB Series Suspension	6-80
Table 6-44: Neway AS Series – Service Rebuild Kits (SRKs)	6-82
Table 6-42: Neway AS Series Suspension	6-78
Table 6-27: NOVA Bus Shocks	6-40
Table 6-30: Prevost Shocks	6-44
Table 6-31: Ridewell Corporation Shocks	6-45
Table 6-32: SAF Holland Shocks	6-45
Table 6-38: SP-172 C AIRTEK® for Blue Bird All American Buses – 1 3.2K/14.6K Capacity, Right Hand Drive Steertek Axle	6-60
Table 6-40: SP-172 C AIRTEK® for Blue Bird Vision Buses – 10K Capacity	6-71
Table 6-37: SP-172 C SOFTEK® for Blue Bird All American Buses – 13.2K/14.6K Capacity, Left Hand Drive Steertek Axle	6-57
Table 6-39: SP-172 C SOFTEK® for Blue Bird Vision Buses – 8K/10K Capacity	6-67
Table 6-41: SP-173 C Comfort Air	6-75
Table 6-36: SP-217 B AIRTEK® for International IC Bus Vehicles	6-53
Table 6-33: Thomas Built School Bus Shocks	6-49
Table 6-34: TMC (Transportation Manufacturing Corporation) Shocks	6-50
Table 6-1: TRP® Bus Air Springs	6-5
Table 6-35: Van Hool Shocks	6-51

Engine Kits Tables

Table 7-29: Camshafts & Lifters for DT466ABC	7-28
Table 7-4: Charge Air Coolers	7-13
Table 7-28: Crankshafts & Seals for DT466ABC	7-28
Table 7-38: Crankshafts & Seals for DT466E	7-36
Table 7-25: Cylinder Components for DT466ABC	7-25
Table 7-34: Cylinder Components for DT466E	7-31
Table 7-26: Cylinder Head Components for DT466ABC	7-26
Table 7-35: Cylinder Head Parts for DT466E - ESN 1194038	7-33
Table 7-36: Cylinder Head Parts for DT466E - ESN 1194039 - 2000000	7-34
Table 7-27: Engine Bearings for DT466ABC	7-27

Table 7-37: Engine Bearings for DT466E	7-35
Table 7-6: Fan Drive Kits from BorgWarner	7-14
Table 7-5: Fan Drives from BorgWarner	7-14
Table 7-7: Fan Drives from Horton	7-15
Table 7-9: Fan Kits from BorgWarner	7-21
Table 7-10: Fan Kits from BorgWarner	7-21
Table 7-12: Fans - Blue Bird Aftermarket	7-22
Table 7-11: Fans - Blue Bird OE	7-22
Table 7-8: Fans from BorgWarner	7-19
Table 7-13: Fans - MCI	7-22
Table 7-14: Fans - NABI	7-22
Table 7-15: Fans - Navistar	7-22
Table 7-16: Fans - Neopart	7-23
Table 7-17: Fans - New Flyer	7-23
Table 7-18: Fans - Nova	7-23
Table 7-19: Fans - Orion	7-23
Table 7-20: Fans - Prevost	7-23
Table 7-21: Fans - Thomas Built	7-23
Table 7-2: Freightliner	7-9
Table 7-30: Gaskets for DT466ABC	7-29
Table 7-39: Gaskets for DT466E	7-36
Table 7-23: In-Frame Kits for DT466ABC	7-25
Table 7-33: In-Frame Kits for DT466E	7-30
Table 7-3: International/IC Bus	7-9
Table 7-22: Navistar Basic Engine Identification	7-24
Table 7-31: Oil Coolers & Pumps for DT466ABC	7-30
Table 7-24: Overhaul Kits for DT466ABC	7-25
Table 7-1: Radiators	7-6
Table 7-32: Water System Components for DT466ABC	7-30
Table 7-40: Water System Components for DT466E	7-37

Air Systems Tables

Table 8-1:	ABS Cables from Meritor	8-5
Table 8-2:	ABS ECU's from Meritor - Cab Mount	8-5
Table 8-3:	ABS Sensors (Straight) from Meritor	8-6
Table 8-26:	ABS Valve Package (Front Axle) from Meritor	8-25
Table 8-21:	Additional Air Governors	8-20
Table 8-33:	Additional Control Valves	8-29
Table 8-30:	Additional Double Check Valves	8-27
Table 8-24:	Additional Dual Brake Foot Valves	8-22
Table 8-38:	Additional Pressure Protection Valves	8-32
Table 8-42:	Additional Quick Release Valves	8-35
Table 8-48:	Additional Relay Valves	8-39
Table 8-28:	Additional Single Check Valves	8-26
Table 8-52:	Additional Spring Brake Valves	8-42
Table 8-58:	Additional Stop Light Switches	8-46
Table 8-4:	Air Brake Hardware (Adapters) from Meritor	8-7
Table 8-12:	Air Brake Hardware (Bolts & Frame Couplings) from Meritor	8-9
Table 8-5:	Air Brake Hardware (Connectors) from Meritor	8-7
Table 8-6:	Air Brake Hardware (Connectors w/ Spring Guards) from Meritor	8-7
Table 8-7:	Air Brake Hardware (Ferrules) from Meritor	8-8
Table 8-8:	Air Brake Hardware (Inserts) from Meritor	8-8
Table 8-9:	Air Brake Hardware (Nuts) from Meritor	8-8
Table 8-10:	Air Brake Hardware (Sensor Clips) from Meritor	8-8
Table 8-11:	Air Brake Hardware (Spring Guards) from Meritor	8-9
Table 8-13:	Air Brake Hardware (Unions) from Meritor	8-10
Table 8-50:	Bendix SR-1 Spring Brake Valves	8-41
Table 8-51:	Bendix SR-7 Spring Brake Valves	8-41
Table 8-55:	Brake Button Covers from Bendix	8-45
Table 8-56:	Brake Button Covers from Meritor	8-45

Table 8-25:	BVA-85 Brake Valve Actuators from Bendix	8-24
Table 8-14:	Bulk Air Brake Hose from Meritor	8-11
Table 8-34:	Control Valves from Meritor	8-29
Table 8-19:	D-2 Air Governors from Bendix	8-19
Table 8-20:	D-2 Air Governors Maintenance Kit from Bendix	8-19
Table 8-15:	Desiccant Air Dryers	8-13
Table 8-29:	Double Check Valves from Bendix	8-27
Table 8-23:	Dual Brake Foot Valves from Bendix	8-21
Table 8-22:	E-8P & E-10P Brake Valves from Bendix	8-21
Table 8-45:	Relay Valves (Horizontal Ports) from Bendix	8-37
Table 8-54:	Park Brake Switches from Meritor	8-44
Table 8-31:	PP-1 Control Valves from Bendix	8-28
Table 8-32:	PP-DC Control Valves from Bendix	8-28
Table 8-36:	PR-2 Pressure Protection Valves from Bendix	8-31
Table 8-37:	PR-4 Pressure Protection Valves from Bendix	8-31
Table 8-39:	QR-1 Quick Release Valves from Bendix	8-33
Table 8-41:	QRN-2 Quick Release Valves from Bendix	8-34
Table 8-40:	QRN Quick Release Valves from Bendix	8-33
Table 8-35:	R-7 Modulating Valves from Bendix	8-30
Table 8-44:	HR-1 Relay Valves from Bendix	8-37
Table 8-47:	Relay Valves (Maintenance Kits) from Bendix	8-39
Table 8-46:	Relay Valves (Vertical and Horizontal Ports) from Bendix	8-38
Table 8-43:	Relay Valves (Vertical Ports) from Bendix	8-36
Table 8-17:	Remanufactured Air Compressors (Replaces Bendix BX2150)	8-17
Table 8-18:	Remanufactured Air Compressors (Replaces Bendix TU-FLO)	8-18
Table 8-27:	Single Check Valves from Bendix	8-26
Table 8-49:	ST-3 Safety Valves from Bendix	8-40
Table 8-57:	Stop Light Switches from Bendix	8-46
Table 8-53:	Switches - Low Pressure Indicators (Bendix)	8-43
Table 8-16:	Wabco Air Dryers from Meritor	8-14

Emissions Tables

Table 9-10: Cross Reference for Emissions	9-9
Table 9-1: DOC Catalysts - AZ Purifiers	9-3
Table 9-2: DOC Catalysts - AZ Purimufflers	9-3
Table 9-5: DPF Control Panels	9-6
Table 9-3: DPF Filters - Purifilters	9-5
Table 9-4: DPF Filters - PurifilterPLUS	9-5
Table 9-6: Exhaust Clamps	9-7
Table 9-7: Exhaust Flex Hoses	9-7
Table 9-9: Exhaust Mufflers	9-8
Table 9-8: Exhaust Pipes	9-8

Cold Weather Tables

Table 10-1: Espar E-Guardian Heater Series (School bus)	10-3
Table 10-3: Hotstart Immersion Heaters, for Caterpillar Engines	10-5
Table 10-4: Phillips & Temro/ Zerostart	10-5
Table 10-2: Webasto Heaters, DBW2010 & Thermo Top	10-4

Transmissions Tables

Table 11-2: Automatic Transmissions for Canada - Remanufactured by Mascot	11-4
Table 11-1: Automatic Transmissions for Canada - Remanufactured by Weller	11-3
Table 11-5: Automatic Transmissions for U.S. - Remanufactured by Weller	11-6
Table 11-7: Bus Applications Table for Allison Transmissions	11-8
Table 11-4: Manual Transmissions for Canada - Remanufactured by Mascot	11-5
Table 11-3: Manual Transmissions for Canada - Remanufactured by Weller	11-4
Table 11-6: Manual Transmissions for U.S. - Remanufactured by Weller	11-7

Filtration Tables

Table 12-1: Air Filters for Blue Bird	12-11
---	-----------------------

Table 12-7: Air Filters for Collins	12-23
Table 12-13: Air Filters for Corbeil	12-27
Table 12-19: Air Filters for Ford	12-31
Table 12-22: Air Filters for Freightliner	12-33
Table 12-32: Air Filters for International/ IC Bus	12-43
Table 12-39: Air Filters for Mid Bus	12-52
Table 12-45: Air Filters for Thomas Built	12-56
Table 12-52: Air Filters for Van Hool	12-63
Table 12-53: Air/Oil Separator Filters for Van Hool	12-63
Table 12-2: Coolant Filters for Blue Bird	12-12
Table 12-28: Coolant Filters for Gillig LLC	12-41
Table 12-33: Coolant Filters for International/ IC Bus	12-44
Table 12-46: Coolant Filters for Thomas Built	12-57
Table 12-3: Fuel Filters for Blue Bird	12-12
Table 12-8: Fuel Filters for Collins	12-23
Table 12-14: Fuel Filters for Corbeil	12-27
Table 12-23: Fuel Filters for Freightliner	12-34
Table 12-29: Fuel Filters for Gillig LLC	12-41
Table 12-34: Fuel Filters for International/ IC Bus	12-45
Table 12-40: Fuel Filters for Mid Bus	12-52
Table 12-47: Fuel Filters for Thomas Built	12-57
Table 12-54: Fuel Filters for Van Hool	12-64
Table 12-4: Fuel/Water Separator Filters for Blue Bird	12-14
Table 12-9: Fuel/Water Separator Filters for Collins	12-24
Table 12-15: Fuel/Water Separator Filters for Corbeil	12-28
Table 12-24: Fuel/Water Separator Filters for Freightliner	12-35
Table 12-30: Fuel/Water Separator Filters for Gillig LLC	12-41
Table 12-35: Fuel/Water Separator Filters for International/ IC Bus	12-46
Table 12-41: Fuel/Water Separator Filters for Mid Bus	12-53
Table 12-48: Fuel/Water Separator Filters for Thomas Built	12-58

Table 12-55: Fuel/Water Separator Filters for Van Hool	12-65
Table 12-56: Hydraulic Filters for Van Hool	12-65
Table 12-5: Lube/Oil Filters for Blue Bird	12-16
Table 12-10: Lube/Oil Filters for Collins	12-24
Table 12-16: Lube/Oil Filters for Corbeil	12-28
Table 12-20: Lube/Oil Filters for Ford	12-31
Table 12-25: Lube/Oil Filters for Freightliner	12-36
Table 12-31: Lube/Oil Filters for Gillig LLC	12-42
Table 12-36: Lube/Oil Filters for International/ IC Bus	12-47
Table 12-42: Lube/Oil Filters for Mid Bus	12-53
Table 12-49: Lube/Oil Filters for Thomas Built	12-59
Table 12-57: Lube/Oil Filters for Van Hool	12-65
Table 12-11: Steering Filters for Collins	12-25
Table 12-17: Steering Filters for Corbeil	12-29
Table 12-26: Steering Filters for Freightliner	12-37
Table 12-37: Steering Filters for International/ IC Bus	12-48
Table 12-43: Steering Filters for Mid Bus	12-54
Table 12-50: Steering Filters for Thomas Built	12-60
Table 12-58: Steering Filters for Van Hool	12-66
Table 12-6: Transmission Filters for Blue Bird	12-18
Table 12-12: Transmission Filters for Collins	12-25
Table 12-18: Transmission Filters for Corbeil	12-29
Table 12-21: Transmission Filters for Ford	12-32
Table 12-27: Transmission Filters for Freightliner	12-37
Table 12-38: Transmission Filters for International/ IC Bus	12-49
Table 12-44: Transmission Filters for Mid Bus	12-54
Table 12-51: Transmission Filters for Thomas Built	12-60
Table 12-59: Water Filters for Van Hool	12-67

Fluids Tables

Table 13-10: Chevron Chassis Grease	13-11
Table 13-5: Chevron Heavy Duty Engine Oil	13-8
Table 13-7: Chevron Transmission Fluid	13-9
Table 13-1: CleanBlue® Products	13-4
Table 13-8: Delvac Synthetic Automatic Transmission Fluid	13-10
Table 13-12: Shell Axle/Gear Oil	13-12
Table 13-11: Shell Chassis Grease	13-11
Table 13-4: Shell Engine Coolant for U.S.	13-7
Table 13-6: Shell Heavy Duty Engine Oil for U.S.	13-8
Table 13-9: Shell Transmission Fluid for U.S. & Canada	13-10
Table 13-2: TRP® Coolant for U.S. & Mexico	13-5
Table 13-3: TRP® Coolant Labeled For Canadian	13-6
Table 13-13: Wiper Fluid	13-13

Seats Tables

Table 14-1: Driver's Seats - All Make Fit	14-4
Table 14-2: Driver's Seats - Bluebird & Carpenter	14-5
Table 14-3: Driver's Seats - Bluebird & Carpenter	14-10
Table 14-4: Driver's Seats - Coveralls - Highback	14-15

Electrical Tables

Table 15-6: AGM, Dual Purpose & Starting Batteries – Excluding Mexico	15-11
Table 15-1: Alternators - Delco Remy	15-5
Table 15-2: Alternators - Leece-Neville	15-6
Table 15-11: Battery Cable 90° Ring Terminals	15-14
Table 15-12: Battery Cable Elbow Ring Terminals	15-15
Table 15-9: Battery Cables, Bulk	15-13
Table 15-8: Battery Cables, Custom Crimp Cables	15-13

Table 15-18: Battery Cables - End Protectors, Tubing & Accessories, Battery Cable Nut Caps	15-18
Table 15-21: Battery Cables - End Protectors, Tubing & Accessories, Cable Clamp Heat Shrink	15-19
Table 15-19: Battery Cables - End Protectors, Tubing & Accessories, Clamp Protectors	15-18
Table 15-20: Battery Cables - End Protectors, Tubing & Accessories, Elbow Clamp Protectors	15-19
Table 15-22: Battery Cables - End Protectors, Tubing & Accessories, Split Loom (Convuluted Tubing)	15-19
Table 15-23: Battery Cables - Negative Cables	15-20
Table 15-13: Battery Cable Splices	15-15
Table 15-15: Battery Cables - Tapered Post Connectors, Elbow Clamps	15-16
Table 15-16: Battery Cables - Tapered Post Connectors, Flag Clamps	15-17
Table 15-14: Battery Cables - Tapered Post Connectors, Straight Clamps	15-16
Table 15-17: Battery Cables - Tapered Post Connectors, Universal Straight Clamps	15-17
Table 15-10: Battery Cable Straight Ring Terminals	15-14
Table 15-50: Cable Tie Tools	15-55
Table 15-31: Circuit Breakers - Plug-In	15-35
Table 15-29: Connector Bodies & Shells	15-26
Table 15-43: Connectors: Miscellaneous Connectors & Plugs	15-49
Table 15-42: Connectors: Nylon Insulated Terminals	15-48
Table 15-41: Connectors: Seals, Retainers, & Combs	15-47
Table 15-38: Connectors: Sleeves, Sockets, Pins	15-44
Table 15-44: Connectors: Splice	15-49
Table 15-39: Connectors: Terminal Ends for Fuses and Relays	15-46
Table 15-40: Connectors: Terminal Ends for Fuses and Relays	15-47
Table 15-37: Connectors: Terminal Ends - Spade/Slide	15-41
Cross Reference for Battery Cables	15-56
Table 15-48: Deutsch Connector Tools	15-54
Table 15-36: Electrical Flashers	15-40
Table 15-34: Electrical Relays	15-38

Table 15-49: Electrical Tools, Miscellaneous	15-55
Table 15-30: Fuses – Universal CB for ATC®/ATO® Blade Type Fuses	15-34
Table 15-35: Relay Blocks and Fuse Blocks	15-39
Table 15-47: Specialty Cable Ties	15-52
Table 15-45: Stainless Steel Cable Ties	15-50
Table 15-46: Standard Cable Ties	15-51
Table 15-3: Starters - Delco Remy	15-7
Table 15-4: Starters - Leece-Neville	15-8
Table 15-5: Starters - Mitsubishi	15-9
Table 15-7: Starting Batteries – Mexico Only	15-12
Table 15-32: Stud Terminal Circuit Breakers	15-36
Table 15-24: Switches – Assorted	15-21
Table 15-25: Switches – Pressure	15-22
Table 15-26: Switches – Push Button	15-23
Table 15-27: Switches – Rocker	15-24
Table 15-28: Switches – Toggle	15-25
Table 15-33: Thermal Circuit Breakers	15-37

Audio/Video Tables

Table 16-2: AM/ FM Radios	16-4
Table 16-1: AM/ FM Radios with CD Players	16-3
Table 16-5: Antennas	16-6
Table 16-8: Camera Equipment: Camera Video System	16-8
Table 16-9: Camera Equipment: Dual-Vision™	16-8
Table 16-7: Horns	16-7
Table 16-3: Microphones	16-4
Table 16-4: Radio Faceplate Panels	16-5
Table 16-6: Speakers & Grills	16-6

Lighting Tables

Table 17-1: Bus Strobe Lamps	17-5
Table 17-15: Halogen Flood Lamps	17-21
Table 17-17: Halogen Headlamp Bulbs	17-22
Table 17-16: Halogen Warning Lamps	17-21
Table 17-18: Headlamp Assemblies	17-23
Table 17-19: Headlamp Bezels, Gaskets & Nests	17-24
Table 17-12: Incandescent Backup Lamps	17-17
Table 17-8: Incandescent Clearance & Marker Lamps	17-13
Table 17-9: Incandescent Interior & Courtesy Lamps	17-14
Table 17-14: Incandescent Lenses	17-19
Table 17-13: Incandescent Reflectors	17-18
Table 17-10: Incandescent Step Lamps	17-15
Table 17-11: Incandescent Stop, Turn & Tail Lamps	17-15
Table 17-2: LED Backup Lamps	17-6
Table 17-3: LED Bus Marker Lamps	17-7
Table 17-4: LED Clearance & Marker Lamps	17-8
Table 17-5: LED Interior & Courtesy Lamps	17-10
Table 17-6: LED Mounting Accessories	17-10
Table 17-7: LED Stop, Turn & Tail Lamps	17-11
Table 17-20: Lighting - Blue Bird	17-25
Table 17-21: Lighting - International/IC Bus	17-25
Table 17-22: Lighting - Thomas Built	17-25

HVAC Tables

Table 18-12: Air Filters	18-17
Table 18-7: Booster Pump Motors	18-14
Table 18-8: Booster Pumps	18-14
Table 18-23: Cross Reference for HVAC	18-20
Table 18-10: Defrost Fans - 24v- 24v	18-15

Table 18-9: Defrost Fans- 24v	18-15
Table 18-11: Heater Cores	18-16
Table 18-16: HVAC - Amtram	18-19
Table 18-15: HVAC - A.R. Lintern	18-19
Table 18-17: HVAC - Bluebird	18-19
Table 18-14: HVAC Cable-Controlled Water Valves	18-18
Table 18-18: HVAC - IHC	18-19
Table 18-19: HVAC - Kysor	18-19
Table 18-13: HVAC Manual Water Valves	18-18
Table 18-20: HVAC - Navistar	18-19
Table 18-21: HVAC - Superior	18-19
Table 18-22: HVAC - Thomas Built	18-19
Table 18-1: HVAC - Transit Bus TM16 Series	18-4
Table 18-2: HVAC - Transit Bus - TM21 Series	18-6
Table 18-3: HVAC - Transit Bus - TM31 Series	18-7
Table 18-5: Blower Motors - Double Entry	18-12
Table 18-4: Blower Motors- Single Shaft	18-8
Table 18-6: Blower Wheels - Double Entry	18-13

Glass Tables

Table 19-9: Cross Reference for Glass	19-14
Table 19-2: Windshields - AmTran	19-4
Table 19-3: Windshields - Blue Bird	19-5
Table 19-4: Windshields - Carpenter	19-7
Table 19-5: Windshields - Navistar	19-8
Table 19-6: Windshields - Thomas Built	19-10
Table 19-7: Windshields - Ward	19-12
Table 19-8: Windshields - Wayne	19-13
Table 19-1: Wipers - Premium & Winter	19-3

Mirrors Tables

Table 20-2: Rosco School Bus Mirrors20-4
Table 20-1: TRP® Fender & Blind Spot Mirrors20-3

Safety Tables

Table 21-13: Bendix CVS SmarTire™ Tire Pressure Monitoring System21-16
Table 21-14: Cat's Eye 2-Unit Retail Bubble Pack21-17
Table 21-15: Cat's Eye 4-Unit Box21-18
Table 21-9: Emergency & Safety Kits21-14
Table 21-8: Fire Extinguishers21-13
Table 21-6: First Aid Kit - 10-Person21-9
Table 21-7: First Aid Kit - 25-Person21-10
Table 21-5: First Aid Kit - Automotive21-8
Table 21-4: First Aid Kit - Large All-Purpose21-7
Table 21-3: First Aid Kit - Small All-Purpose21-6
Table 21-10: Permit Holders21-14
Table 21-12: Pressure Pro Tire Pressure Monitoring System21-16
Table 21-2: School Bus Conspicuity Tape21-4
Table 21-1: School Bus Signs21-4
Table 21-11: Tire Chains - Onspot of North America Inc.21-15

NOTES

NOTES

A large rectangular area filled with a light blue grid pattern, intended for writing notes. The grid consists of small squares and covers most of the page's content area.

NOTES

A large grid of graph paper for taking notes, consisting of 20 columns and 30 rows of small squares.



\$19.95

*For information, updates, or corrections,
please contact us at TRPBus@TRPParts.com*

*No part of this marketing material may be
reproduced in any manner without written
permission from TRP® North America.*

TRP® North America

750 Houser Way N.
Renton, WA 98057

www.trpparts.com