



POWER TAKE-OFF (PTO) PROVISION — SYSTEM DESIGN —

ALLISON ON-HIGHWAY TRANSMISSIONS

APPLICABLE MODELS: 1000 Product Family
2000 Product Family

Contents:

1.0 Introduction

2.0 Referenced Documents

3.0 PTO System Design Considerations

3.1 The PTO Drive Provision

3.1.1 Power Flow

3.2 Selecting a PTO Unit

3.3 System Operation – Transmission in Converter Mode

3.3.1 Estimating PTO Performance in Converter Mode

3.4 System Operation – Transmission in Lockup Mode

3.4.1 Estimating PTO Performance in Lockup Mode

3.5 Designing the PTO Installation

3.5.1 PTO Pad Bending Moment Limit

3.5.2 PTO-Mounted Equipment

3.5.3 PTO Lubrication Circuit

3.5.4 Clutched-Drive PTO Controls

3.5.5 PTO-Related Input and Output (I/O) Functions

3.5.6 Service Considerations

4.0 Additional Considerations

Appendix A: PTO Performance Charts - Metric Units

Appendix B: PTO Performance Charts - U.S. Units

List of Referenced Documents

Revision History

POWER TAKE-OFF (PTO) PROVISION – SYSTEM DESIGN – 1000/2000 PRODUCT FAMILY –

1.0 INTRODUCTION

The purpose of this document is to summarize design considerations specific to the power take-off (PTO) provisions and PTO units used with transmissions in the Allison 1000 and 2000 Product Family. The following general information on PTO systems can be found in [Power Take-Off – General System Design](#):

- Types of transmission-mounted PTO units
- Selecting a transmission-mounted PTO unit
- Interface of the PTO system with the transmission electronic controls
- Split-shaft PTOs

A step-by-step procedure for installing a PTO directly to the transmission is included in [Transmission-Mounted PTO Installation Instructions](#) for the 1000/2000 Product Family.

2.0 REFERENCED DOCUMENTS

Unless otherwise noted, all documents referenced in this document may be found in the Extranet channel of the Allison Transmission website, www.allisontransmission.com. To locate the referenced documents look for Tech Data under the Engineering heading on the Extranet home page. In this document, these references are identified by *italic* font. Contact your Allison Transmission representative if you do not have access to the Allison Transmission Extranet. A list of all documents referenced in this document can be found at the end of this document.

3.0 PTO SYSTEM DESIGN CONSIDERATIONS

The PTO system consists of the following:

- the transmission PTO drive gear and mounting pad on the transmission housing
- the PTO unit, or PTO model, referring to the mechanism that is bolted to the transmission mounting pad
- the equipment driven by the PTO unit, such as a pump or a hydraulic motor

3.1 THE PTO DRIVE PROVISION

- All 1000 and 2000 Product Family transmissions have two PTO mounting pads. The PTO mounting pads are located on either side of the main case near the center (lengthwise) of transmission. Refer to [Installation Drawing AS64-480, PTO Provision](#), for dimensional details.
- Relative positions of mounted PTO units, as viewed from the rear of the transmission, are illustrated in Figure 1.
- Both mounting pads have SAE Standard-Duty six-bolt hole patterns.
- As shipped from the Allison factory, each PTO mounting pad is sealed with a gasket and a cover plate.
- If the transmission includes the PTO drive provision, a large PTO drive gear is located under the PTO cover plate.

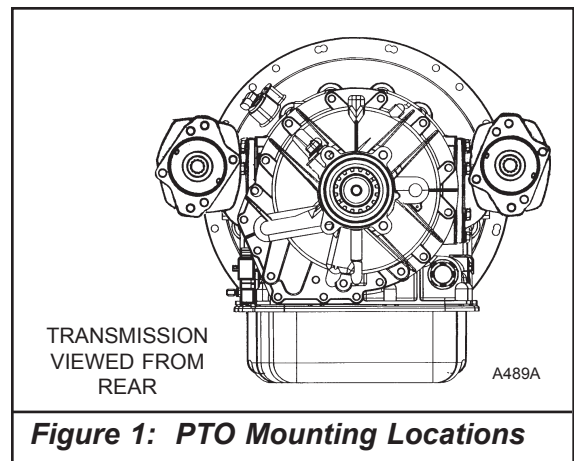

- In the 1000/2000 Product Family, the PTO drive provision is standard on some models, not available with some models, and optional for some models. Refer to [1000/2000 Product Family Features and Options](#) to determine the availability of the PTO drive provision for a particular transmission model.
- A secondary use of the PTO drive gear in the transmission is to generate a speed signal representing transmission turbine speed. This is accomplished through use of a sensor which detects the speed of the tips of the PTO drive gear teeth. In order to generate the required turbine speed signal in non-PTO transmissions, the PTO drive gear is replaced with a metal cage "tonewheel".

CAUTION: DO NOT INSTALL A PTO ON A TRANSMISSION WHICH IS EQUIPPED WITH A SPEED SENSOR TONEWHEEL. The tonewheel has insufficient strength to provide an adequate drive for the PTO. The tonewheel will also become distorted through contact with components in the PTO assembly. Eventually the damaged tonewheel will not generate an appropriate turbine speed signal for the transmission control system.

If you are uncertain whether your transmission is equipped with a PTO drive gear, the configuration may be determined visually by examining the component which is exposed when the PTO cover is removed. See Figure 2.

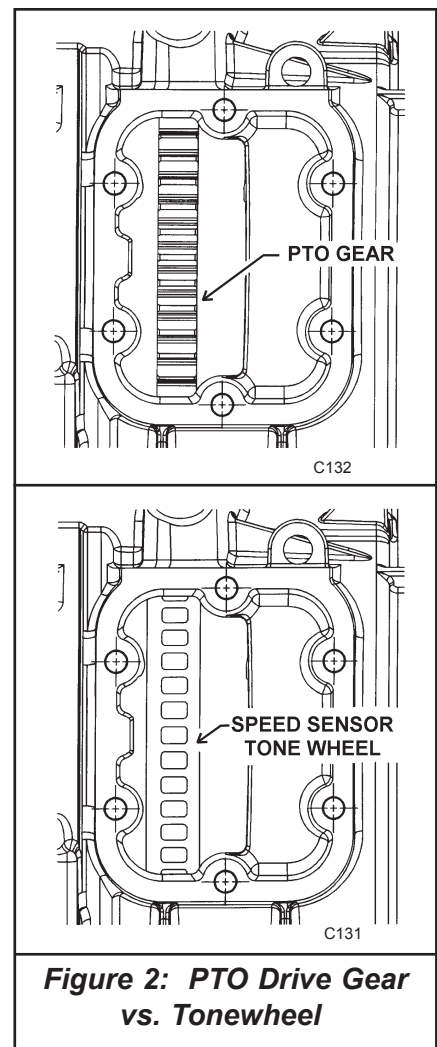

Figure 2: PTO Drive Gear vs. Tonewheel

- The PTO drive gear in the transmission has a maximum allowable torque rating. This rating depends upon whether one or both PTO pads are used. Refer to [Power Take-Off – General System Design](#) for a detailed description of how to determine the drive gear rating. The PTO drive gear ratings can be found in [1000/2000 Product Family Transmission Data](#).
- The PTO drivetrain consists of the large drive gear in the transmission, an idler gear set or input gear, and a smaller driven gear in the PTO unit. As a result, the PTO output rotates in the same direction as the engine. The transmission PTO drive gear is integral to the transmission rotating clutch housing, which rotates at the same speed as the torque converter turbine.

3.1.1 POWER FLOW

The transmission PTO drive gear is driven by the torque converter turbine. Refer to Figure 3.

If the torque converter lockup clutch is engaged, the speed of the PTO drive gear is equal to engine speed and the operation is denoted as "lockup mode". This operation normally occurs when operating the transmission in the upper gear ranges.

If the lockup clutch is not engaged, PTO drive gear speed is reduced as a function of engine speed, loading, and the torque converter model. This operation is denoted as "converter mode". The transmis-

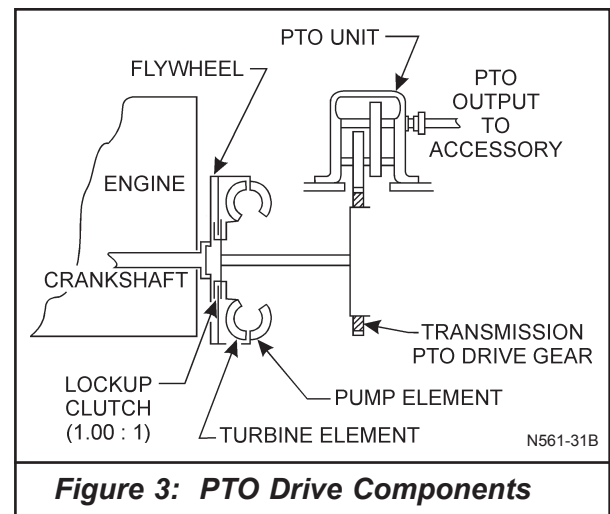

Figure 3: PTO Drive Components

sion normally operates in converter mode when in Park, Neutral, Reverse, and in the lower forward gears.

PTO operation in converter has different advantages than PTO operation in lockup mode, as discussed in paragraphs 3.3 and 3.4, below.

If the PTO is used with the transmission in DRIVE or another forward gear, the PTO drive gear speed will be affected each time a shift occurs. This includes both shifts between gears and shifts between converter and lockup mode. Each of these shifts are based on the automatic shift sequence of the transmission shift controls. Refer to [Allison 5th Generation Controls Manual Section B: System Operation for the 1000/2000 Product Family](#) for more information regarding shift sequences commonly used with these transmission models.

3.2 SELECTING A PTO UNIT

- Various types of PTO units are commercially available for use with these transmission models. These include a variety of PTO driven gear sizes, which result in a selection of PTO output ratios with respect to engine speed. Refer to [Power Take-Off \(PTO\) – General System Design](#) for a detailed discussion on this topic.
- All PTO units are selected, supplied and installed by the vehicle builder. A list of PTO suppliers is provided in [Transmission Support Equipment](#).
- PTO units must have an SAE Standard-Duty PTO six-hole bolt pattern mounting provision.

Because the 1000/2000 transmission PTO drive gear is converter driven, it is rotating whenever the vehicle is moving or whenever the vehicle is stopped with the engine running and the transmission in Park or Neutral. Allison Transmission has developed a special PTO engagement control feature for 1000/2000 Product Family models that can be used with a constant mesh mechanical shift PTO where the sliding gear/spline is electrically actuated. When interfaced properly, this feature will allow the constant mesh mechanical shift PTO to be engaged in any gear including Park or Neutral when the vehicle is stopped. For detailed information, see [Interface Function - Input CR / Output AN: Synchronized PTO Drive Interface for Mechanical Shift PTO](#).

3.3 SYSTEM OPERATION – TRANSMISSION IN CONVERTER MODE

When the torque converter lockup clutch is not engaged and the PTO is driven through the torque converter, the result is variable speed and variable torque at the PTO drive gear. The speed is always less than engine speed. The torque is always greater than input torque. Actual performance will vary according to the specific operating characteristics of the different torque converter models.

NOTE: With the vehicle stopped and the engine at idle, PTO output speed is dependent upon the transmission gear selection:

- **If the transmission is in a DRIVE gear or REVERSE, PTO output speed is zero.**
- **If the transmission is in NEUTRAL or PARK, the PTO output will rotate slowly.**

At very light PTO loads, the PTO drive speed approaches engine speed. As the PTO load increases, the PTO drive gear slows with respect to engine speed, creating a speed differential between the converter input and output elements — the operating condition in which a torque converter multiplies torque. The torque multiplication factor increases if the speed differential is increased. Therefore, converter-mode PTO operation may be advantageous in operations with variable loads on the PTO-driven accessory. This type of operation also provides a protective hydraulic cushion for the driven equipment.

Disadvantages of converter-mode PTO, operation as compared to lockup operation, are:

- Higher engine speed to achieve the same PTO output speed. This may be of significance if engine noise during PTO operation is of concern.
- Less precise speed control of driven accessories than with lockup mode.

3.3.1 ESTIMATING PTO PERFORMANCE IN CONVERTER MODE

The following discussion and Figure 4 illustrate the procedure for evaluating converter mode PTO operation. To determine the PTO needs for your specific application, apply the example in Figure 4, to the PTO Performance Chart for the torque converter model used in your application. The PTO Performance Charts are located in the following appendices:

APPENDIX A - Metric Units

Figure A-1:	TC-210 Torque Converter
Figure A-2:	TC-211 Torque Converter
Figure A-3:	TC-221 Torque Converter
Figure A-4:	TC-222 Torque Converter

APPENDIX B - U.S. Units

Figure B-1:	TC-210 Torque Converter
Figure B-2:	TC-211 Torque Converter
Figure B-3:	TC-221 Torque Converter
Figure B-4:	TC-222 Torque Converter

NOTE: Before you start this exercise, you should know the PTO speed ratio of the driven-to-drive gears, and the power and torque ratings for the PTO models which may potentially be used in the application.

1. Determine the power required to drive the PTO output and the desired PTO output speed. This topic is discussed in detail in [Power Take-Off \(PTO\) – General System Design](#).
2. In Figure 4, find the required PTO output power on the left scale of the top (power) chart. Refer to point "1". Draw a horizontal line through "1" across the chart. 40.8 kW (62.5 hp) is used for this example.
3. Enter the speed ratio for your PTO model on the left scale of the bottom (speed) chart. Refer to point "2". Draw a horizontal line through point "2". A ratio of 1.123:1 is used in this example.
4. Select the PTO output speed desired to operate the accessory. 2300 rpm is used in this example. Identify the intersection of the PTO ratio line, "2", and the PTO output speed line on the speed chart. See point "3".
5. Draw a vertical line, line "4" in Figure 4, from point "3" upward to the power chart. Note the point at which line "4" intersects the required power line (line "1") on the power chart. This intersection point is noted as item "5" on Figure 4.
6. The relationship of point "5" to the family of dotted-line curves on the top chart illustrates the engine speed required to drive the PTO at its desired speed. Note the curved line ("6") drawn through "point 5", indicating an estimated engine speed of 2160 RPM, in this example.
7. If point "5" lies above the PTO drive gear rating line, a lower PTO gear ratio must be selected to move the operation to conditions of higher speed and lower torque. In Figure 4, this will move all points toward the right on the charts until point "5" is below the PTO drive gear rating line. If

this is not possible, an alternate drive provision, such as an engine mounted PTO, must be considered.

NOTE: The PTO drive gear has two separate rating lines. Verify that point "5" for your application lies below the proper rating line – for one PTO, or for using both PTO drive provisions on the transmission.

8. Point "7" where line "4" intersects the horizontal axis of the power chart indicates the PTO drive gear speed (2050 RPM) at this operating condition. This may be used to calculate transmission output speed, if the transmission is being used for vehicle propulsion simultaneously with PTO use. Transmission output speed is proportional to the PTO drive gear speed by the ratio of the transmission gear in use at the time.

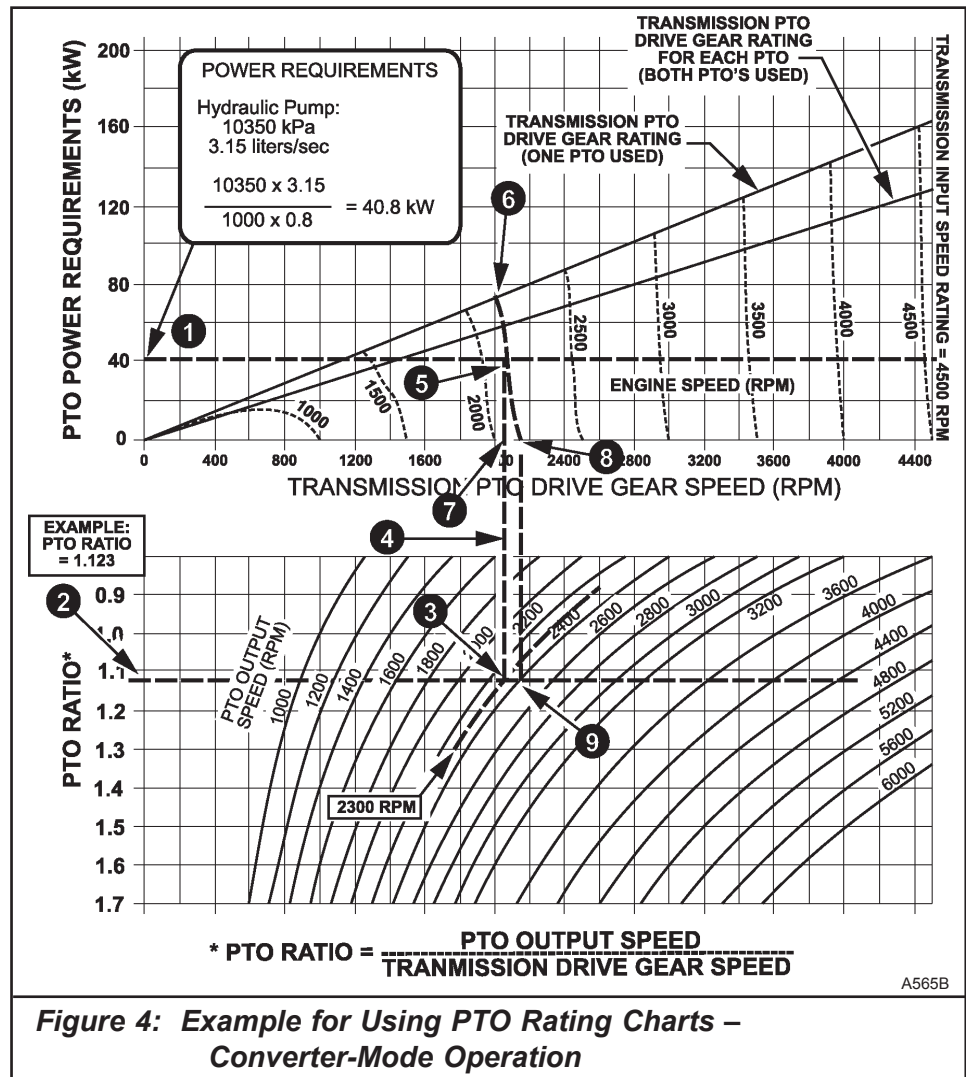

Figure 4: Example for Using PTO Rating Charts – Converter-Mode Operation

9. Follow the engine speed line ("6") to the horizontal scale on the speed chart. See point "8". This is the PTO drive gear speed (same as engine speed) which will be attained if the load is suddenly removed from the PTO ("no-load" condition). Draw a vertical line down to the speed chart to intersect with line "2". This intersection point ("9") denotes the speed of the PTO-driven accessory if a no-load condition exists and the engine speed remains unchanged. In this example, the no-load speed is 2400 rpm.
10. If the speed at no-load exceeds the limitations of the driven accessories, two alternatives may be considered:
- Add a governor which senses PTO speed and regulates engine throttle accordingly to hold the engine speed constant.
 - Select a PTO with a higher gear ratio. This moves operation to higher engine speeds with less speed effects from the converter. That is, the engine speed lines become more vertical and the speed differential between "loaded" and no-load conditions is less pronounced.

The PTO performance analysis assumes steady-state operation at constant engine speed. Theoretically, if the load were increased while at a steady-state condition, the engine speed would remain constant and the PTO output speed would be reduced by an incremental amount. This change would result in more torque multiplication in the torque converter, in turn creating higher output power through the PTO. In actual practice, an increased load to a steady-state condition will result in both lower PTO output speed and lower engine speed, typically necessitating that the operator increase engine speed to maintain performance at the higher load.

3.4 SYSTEM OPERATION – TRANSMISSION IN LOCKUP MODE

When the torque converter lockup clutch is engaged, the PTO drivetrain is driven at a speed directly proportional to the engine speed. A benefit of this operation is the ability to directly control the speed of the driven equipment by controlling the engine speed. And, since the torque converter output is "locked up" to the input, a desired PTO output speed will be achieved at a lower engine speed as compared to operation in converter-mode.

NOTE: This operating condition may be desirable for improved PTO control when the vehicle is stationary — a condition which would normally preclude engagement of the lockup transmission clutch. The transmission controls system [PTO Drive Interface function: Input C / Output G with Neutral Lockup](#), provides a means to engage lockup when the transmission is in NEUTRAL or PARK.

3.4.1 ESTIMATING PTO PERFORMANCE IN LOCKUP MODE

NOTE: Before you start this exercise, you should know the PTO speed ratio of the driven-to-drive gears, and the power and torque ratings for the PTO models which may potentially be used in the application.

1. Determine the power required to drive the PTO output and the desired PTO output speed. This topic is discussed in detail in [Power Take-Off \(PTO\) – General System Design](#).
2. In Figure 5, find the required PTO output power on the left scale of the top (power) chart. Refer to point "1". Draw a horizontal line through "1" across the chart. 40.8 kW (62.5 hp) is used for this example.
3. Enter the speed ratio for your PTO model on the left scale of the bottom (speed) chart. Refer to point "2". Draw a horizontal line through point "2". A ratio of 1.123:1 is used in this example.
4. Select the desired accessory operating speed. 2300 RPM is used in this example. Identify the intersection of the PTO ratio line and the PTO output speed line on the speed chart. See point "3".
5. Draw a vertical line, line "4" in Figure 5, from point "3" upward to the power chart, noting the point at which it intersects the required power line (line "1") on the power chart. This intersection point is noted as item "5" on Figure 5.
6. If point "5" lies above the PTO drive gear rating line, a lower PTO gear ratio must be selected to move the operation to conditions of higher speed and lower torque. In Figure 4, this will move all points toward the right on the charts until point "5" is below the PTO drive gear rating line. If this is not possible, an alternate drive provision, such as an engine-mounted PTO, must be considered.

NOTE: Two separate rating lines are shown for the PTO drive gear. Verify that point "5" for your application lies below the proper rating line – for one PTO, or for using both PTO drive provisions on the transmission.

8. The point ("6") at which line "4" intersects the horizontal axis of the power chart indicates the PTO drive gear speed at this operating condition. Because the converter is in lockup mode, point "6" is also the engine speed. In this example, the PTO drive gear speed and the engine speed are 2050 rpm.

9. If the transmission is being used for vehicle propulsion simultaneously with PTO use, the transmission output speed may be calculated directly from the speed at point "6".

Transmission output speed is proportional to the PTO drive gear speed by the ratio of the transmission gear in use at the time.

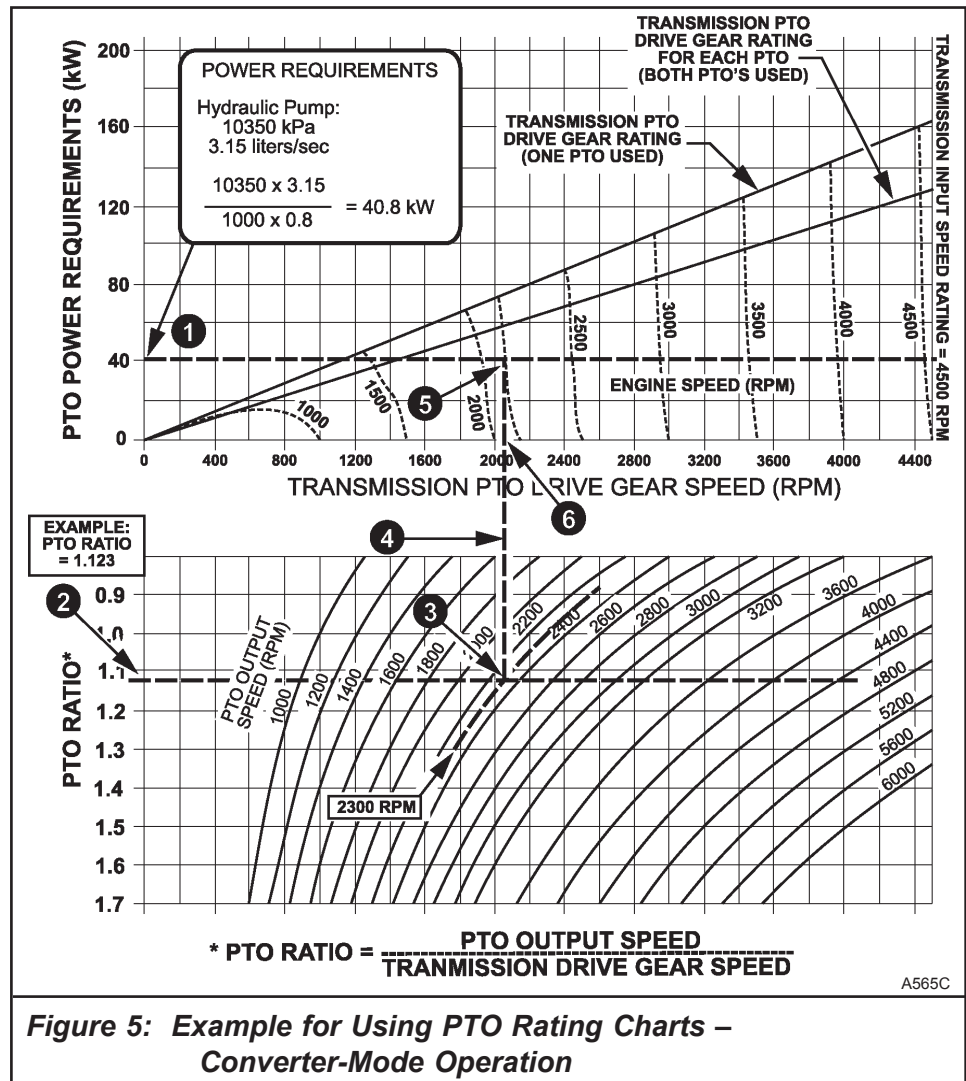

Figure 5: Example for Using PTO Rating Charts – Converter-Mode Operation

3.5 DESIGNING THE PTO INSTALLATION

3.5.1 PTO PAD BENDING MOMENT LIMIT

The transmission PTO pad has a maximum allowable bending moment as shown on [AS64-480, PTO Provision](#). The weight of the PTO unit, plus any equipment, hoses and fittings mounted to the PTO, must not exceed the bending moment limit. Refer to Figure 6.

Allison experience indicates that weights above 20.4 kg (45 lb) are likely to exceed the PTO pad bending moment limit. However, Allison recommends that the bending moment calculation be done for all transmission-mounted PTO installations. If the bending moment limit is exceeded, the moment on the PTO pad must be reduced. Recommendations for reducing the bending moment include:

- adding a rigid support bracket
- moving the PTO-mounted equipment from the PTO to a remote-mounted location on the chassis, with a driveline between the PTO output and the PTO-driven equipment

3.5.2 PTO-MOUNTED EQUIPMENT

Some PTOs are designed to facilitate the flange-mounted installation of a pump or hydraulic motor directly to the PTO. When a pump or other accessory is mounted directly to the transmission-mounted PTO unit, the following vehicle systems should be reviewed to assure that they can handle the additional weight:

- the rear engine mount
- the flywheel housing bending moment limit
- the transmission converter housing bending moment limit
- the transmission rear support
- the transmission PTO pad bending moment limit as described above in paragraph 3.5.1.

Equipment attached to the PTO must meet the following requirements:

- If a bracket is used to support the PTO equipment, attach the rigid support bracket only to the rear cover bolts. The requirements for use of the rear cover bolts are the same as for a rear support bracket. Refer to [AS64-430, Rear Support Provision](#), for location, definition, and requirements for use of the rear cover bolts.

CAUTION: Do NOT attach PTO support brackets to the transmission oil pan bolts.

- The PTO manufacturers also specify when a support bracket is required based on the weight and length of the equipment mounted to the PTO. Contact the PTO manufacturer or the pump manufacturer for available mounting brackets.
- A driveline attached to the PTO output shaft must meet the same speed, angularity, and indexing requirements as a vehicle driveline. These topics are discussed in detail in [Basic Driveline Design](#).
- The PTO-driven equipment should not create a direct side load on the PTO, such as the load from a sprocket or pulley. If the installation requires a drive mechanism of this type, the pulley or sprocket should be mounted on a separate pillow block and be shaft-driven from the transmission-mounted PTO.
- PTO-driven equipment with high inertias must be initially engaged when the transmission is in converter mode. [PTO Drive Interface function](#) with Neutral Lockup, must be used in order to operate high inertia equipment in neutral lockup. Once the transmission is in lockup, do not disengage and re-engage the equipment until the transmission has shifted back into converter mode.

If high inertia loads must be engaged when the transmission is in lockup, drive the equipment through a fluid coupling or hydrostatically — not directly from the PTO output.

CAUTION: When the transmission is in lockup mode, the PTO is coupled directly to the engine. With the transmission in lockup, rapid engagement of a high inertia load to the PTO output may result in engine stall. PTO or transmission damage can also result.

- Hydraulic lines, drive shafts and control mechanisms will probably span from engine to frame and must be designed to avoid restraining the engine from moving freely in its mounts. It is usually preferable to run hoses or shafts parallel to the engine center-line when crossing from engine/transmission to frame. This allows the engine to "roll" without stretching the hose or cables.

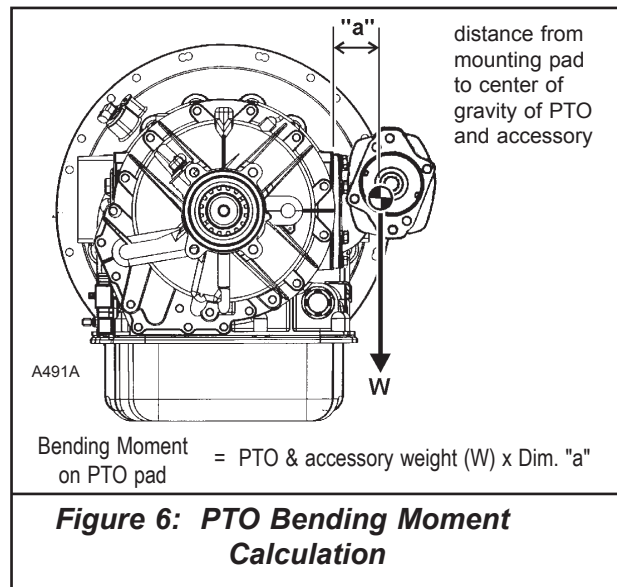

3.5.3 PTO LUBRICATION CIRCUIT

For some PTO assemblies, the spray or splash which passes through the mounting pad opening is adequate for PTO lubrication. This should be confirmed with the PTO manufacturer. If the spray or splash lubrication is not adequate and pressure lubrication is required, a tap off the transmission cooler return line can be fed externally to the pressure lube port on the PTO. To adequately control flow and avoid excess reduction of main transmission lubrication flow, an orifice 0.81 mm (0.032 in) in diameter must be installed in this line. Refer to Figure 7. Some PTO assemblies contain an internal restriction equivalent to the required orifice. Availability of this feature should be confirmed with the PTO manufacturer. The PTO lube line is supplied and installed by the vehicle manufacturer.

NOTE: It is NOT acceptable to use transmission main pressure for PTO lubrication. For the 1000/2000 Product Family, there is only one acceptable use of transmission main pressure for accessories — that being to control engagement of the PTO clutch. This practice is permitted for this function only because the fluid is deadheaded and there is no flow.

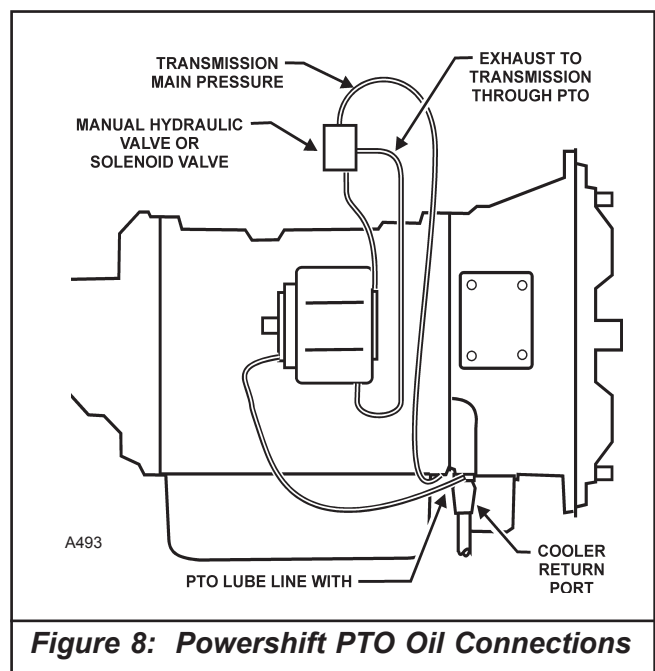
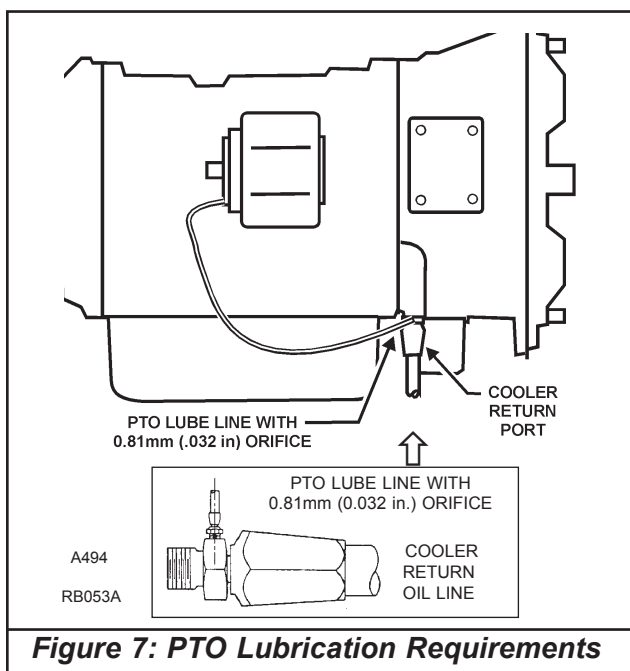

3.5.4 CLUTCHED-DRIVE PTO CONTROLS

If a clutched-drive PTO design is selected, pressurized transmission fluid may be used to apply the PTO clutch. Figure 8 illustrates installation of an external circuit which applies transmission main pressure to the PTO controls solenoid to apply the PTO clutch. This is the only acceptable use of transmission main pressure for accessories, and is permitted for this function only because there is essentially no flow (the fluid is deadheaded). The maximum allowable main pressure leakage at the PTO clutch is 1.0 liter/min at 970 kPa and 49° C (0.26 gal/min at 140 psi and 120° F).

Refer to the [Basic Installation Drawings](#), [AS64-401](#), [AS64-402](#) and [AS64-403](#), for pressure tap locations, size and torque requirements..

NOTE: The transmission controls modulate the main pressure based on operating conditions. This may adversely affect the operation of a clutched-drive PTO. Refer to [Power Take-Off \(PTO\) – General System Design](#) for a description of the issue and its resolution.

The PTO on/off (solenoid) control switch must be wired to the PTO according to instructions provided by the PTO supplier. For suggested wiring interfaces, refer to [Input/Output \(I/O\) Functions](#).

CAUTION: The PTO control circuit must be installed as directed by the instructions included in the PTO Installation Kits. Failure to do so may lead to problems in other electrical system components in the event of PTO or PTO solenoid malfunction.

3.5.5 PTO-RELATED INPUT AND OUTPUT (I/O) FUNCTIONS

The transmission shift controls include options for several input and output functions which have been designed specifically to enhance PTO operation or vehicle operation during PTO use. Refer to [Power Take-Off \(PTO\) – General System Design](#) for further discussion.

For a complete list of input and output functions and their descriptions, refer to [Input/Output \(I/O\) Functions](#) on the Extranet. Available functions and packages of functions differ by transmission model.

3.5.6 SERVICE CONSIDERATIONS

The Allison Transmission Service Department has established maximum removal and replacement (R&R) requirements for Allison transmissions and related components. For R&R information which relates to components discussed in this document, refer to [Technical Document \(TD\) 176, Service Requirements – Removal and Replacement Times for Allison Transmissions](#).

4.0 ADDITIONAL CONSIDERATIONS

Vehicles with auxiliary powered equipment that require full engine power should be evaluated for possible use of a split-shaft PTO. Refer to [Power Take-Off \(PTO\) – General System Design](#).

APPENDIX A – METRIC UNITS

Transmission Models: Allison 1000/2000 Product Family

Torque Converter Model: Allison TC-210

Transmission PTO Drive Gear Data

- Number of Teeth: 64
- Speed in Converter Mode: Less than Engine Speed
- Speed in Lockup Mode: Equal to Engine Speed
- Rating Using one PTO: 339 N-m maximum continuous
- Rating Using two PTO's simultaneously: 271 N-m maximum continuous for each PTO

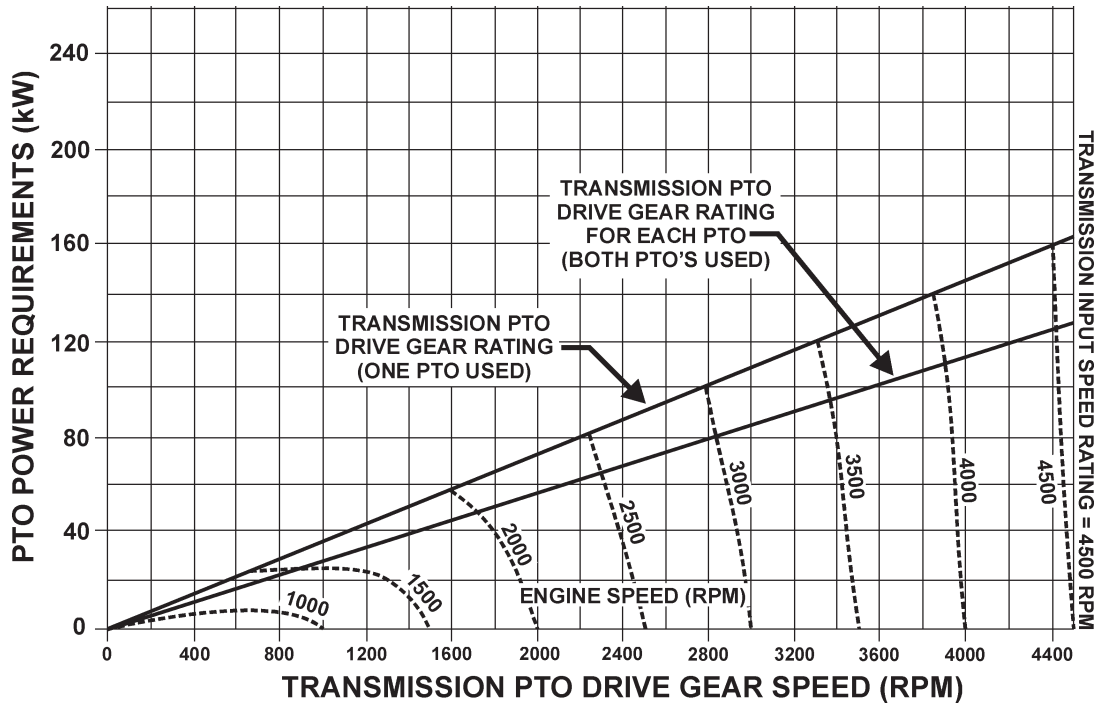

C021
A558

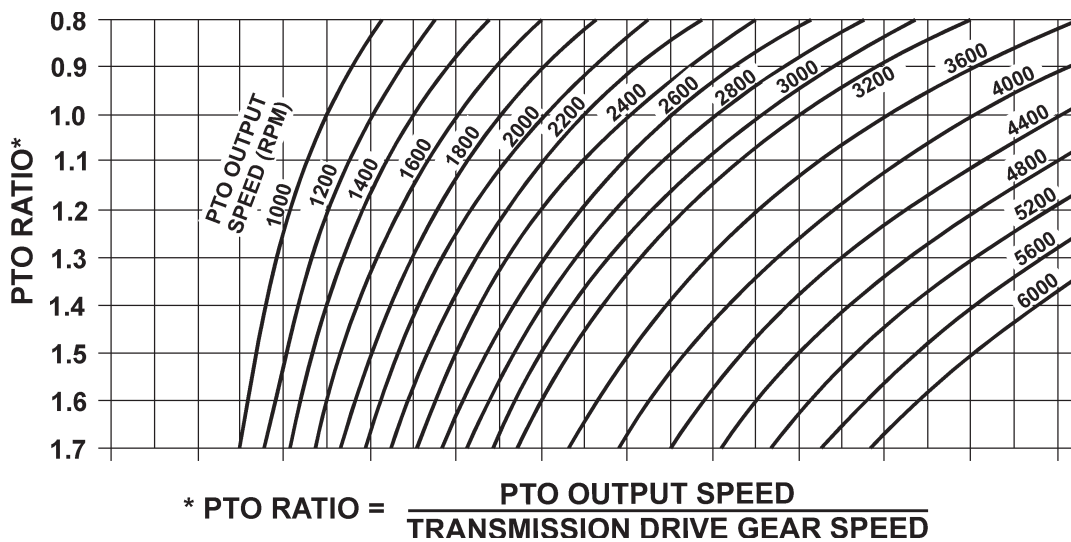

Figure A-1: PTO Performance Chart, Metric Units — TC-210 Torque Converter

APPENDIX A – METRIC UNITS

Transmission Models: Allison 1000/2000 Product Families

Torque Converter Model: Allison TC-211

Transmission PTO Drive Gear Data

- Number of Teeth: 64
- Speed in Converter Mode: Less than Engine Speed
- Speed in Lockup Mode: Equal to Engine Speed
- Rating Using one PTO: 339 N-m maximum continuous
- Rating Using two PTO's simultaneously: 271 N-m maximum continuous for each PTO

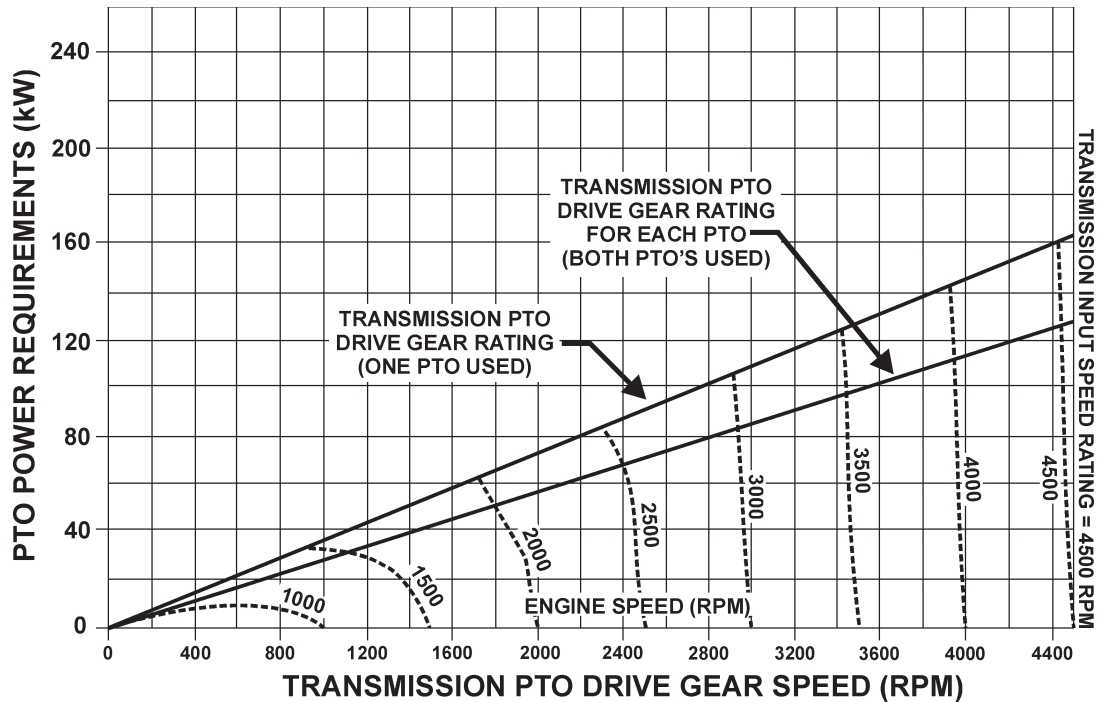

C022
A558

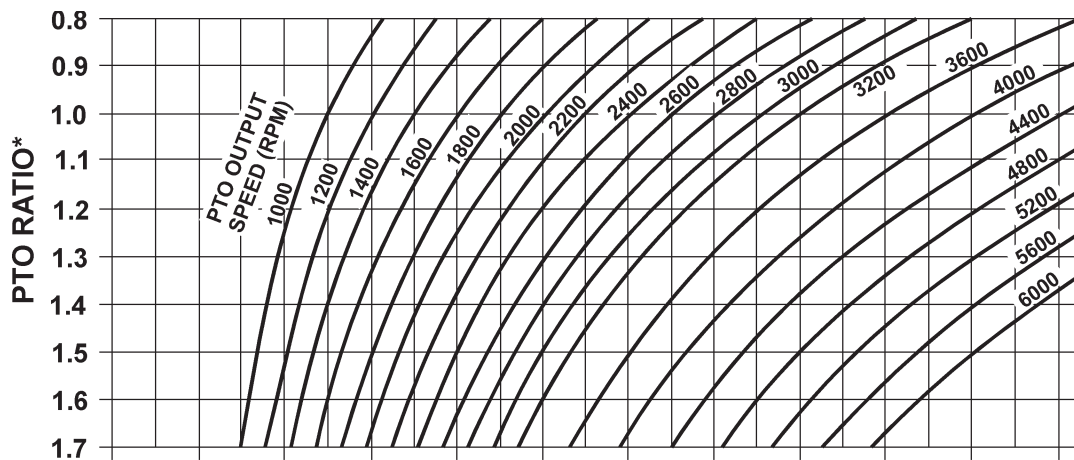

$$* \text{ PTO RATIO} = \frac{\text{PTO OUTPUT SPEED}}{\text{TRANSMISSION DRIVE GEAR SPEED}}$$

Figure A-2: PTO Performance Chart, Metric Units — TC-211 Torque Converter

APPENDIX A – METRIC UNITS

Transmission Models: Allison 1000/2000 Product Families

Torque Converter Model: Allison TC-221

Transmission PTO Drive Gear Data

- Number of Teeth: 64
- Speed in Converter Mode: Less than Engine Speed
- Speed in Lockup Mode: Equal to Engine Speed
- Rating Using one PTO: 339 N-m maximum continuous
- Rating Using two PTO's simultaneously: 271 N-m maximum continuous for each PTO

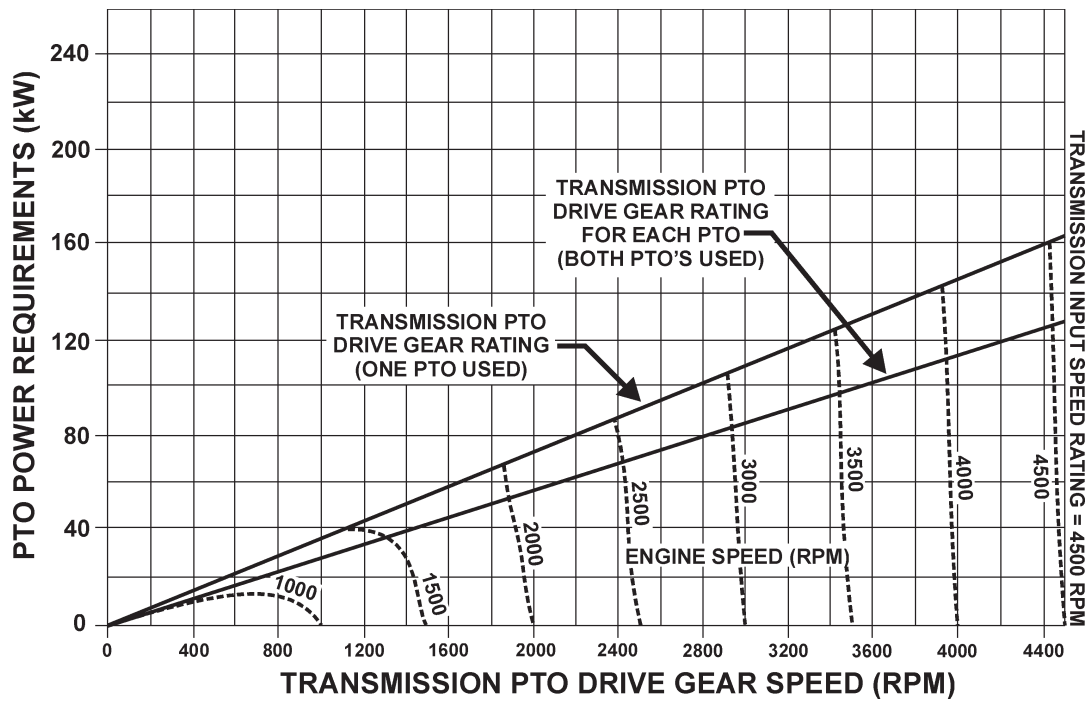

C023
A558

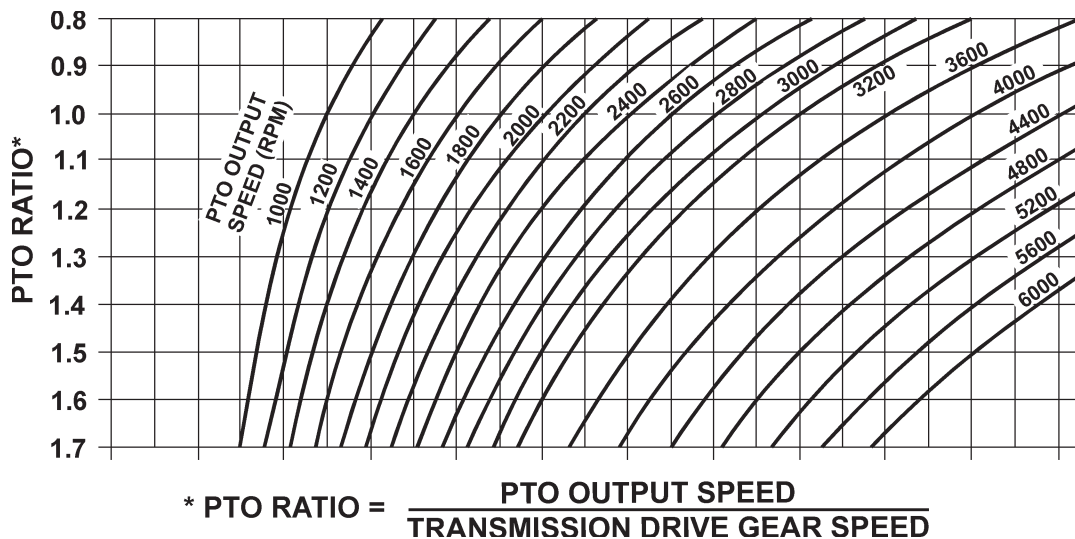

Figure A-3: PTO Performance Chart, Metric Units — TC-221 Torque Converter

APPENDIX A – METRIC UNITS

Transmission Models: Allison 1000/2000 Product Families

Torque Converter Model: Allison TC-222

Transmission PTO Drive Gear Data

- Number of Teeth: 64
- Speed in Converter Mode: Less than Engine Speed
- Speed in Lockup Mode: Equal to Engine Speed
- Rating Using one PTO: 339 N-m maximum continuous
- Rating Using two PTO's simultaneously: 271 N-m maximum continuous for each PTO

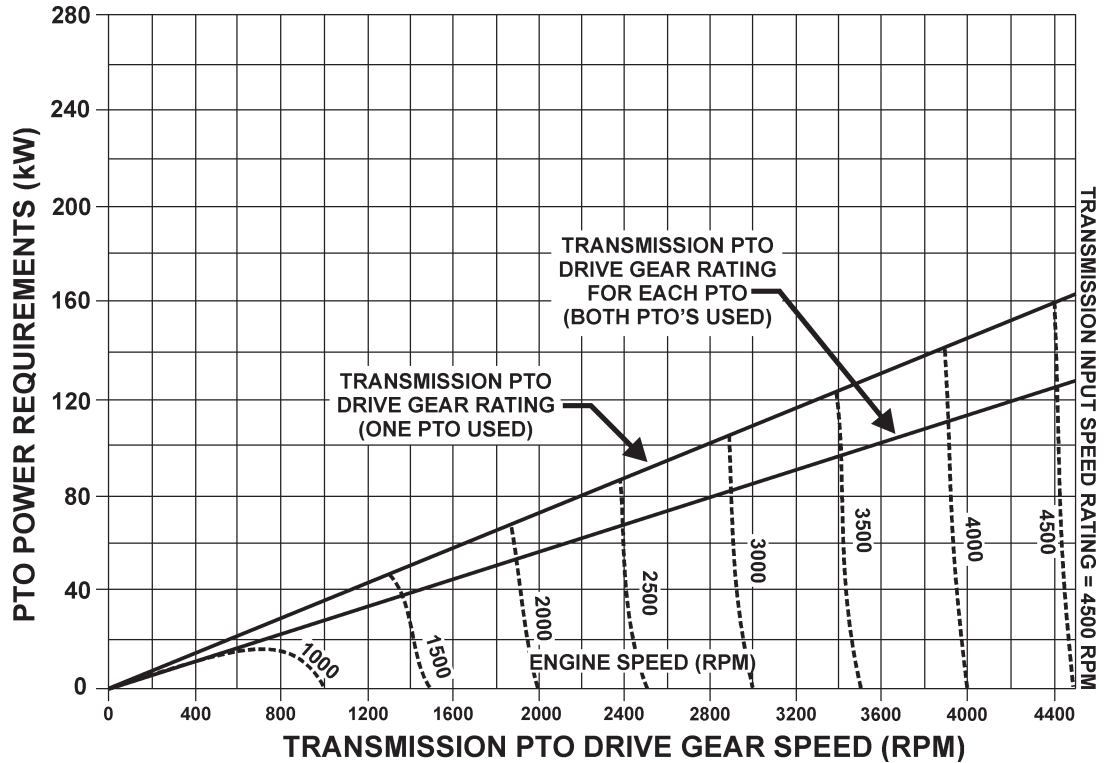

C024A
A558

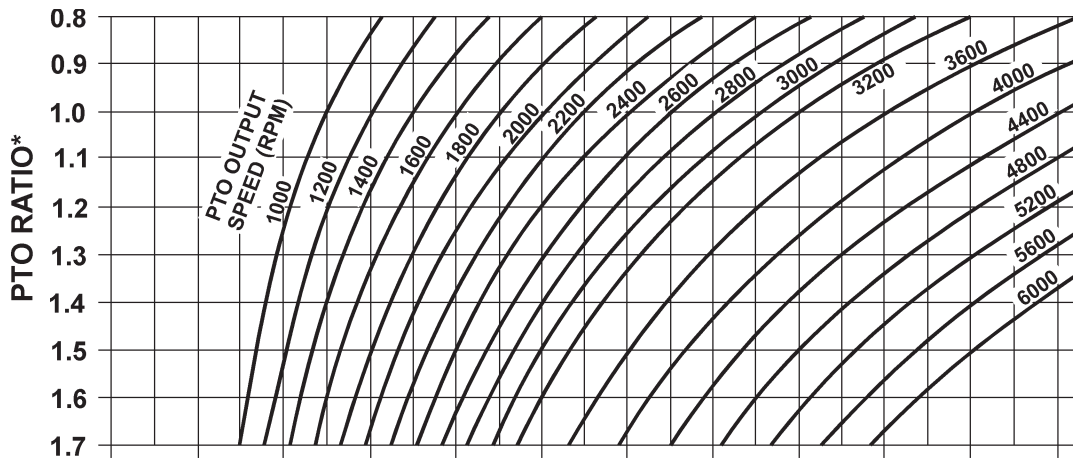

$$* \text{ PTO RATIO} = \frac{\text{PTO OUTPUT SPEED}}{\text{TRANSMISSION DRIVE GEAR SPEED}}$$

Figure A-4: PTO Performance Chart, Metric Units — TC-222 Torque Converter

APPENDIX B – U.S. UNITS

Transmission Models: Allison 1000/2000 Product Families

Torque Converter Model: Allison TC-210

Transmission PTO Drive Gear Data

- Number of Teeth: 64
- Speed in Converter Mode: Less than Engine Speed
- Speed in Lockup Mode: Equal to Engine Speed
- Rating Using one PTO: 250 lb-ft maximum continuous
- Rating Using two PTO's simultaneously: 200 lb-ft maximum continuous for each PTO

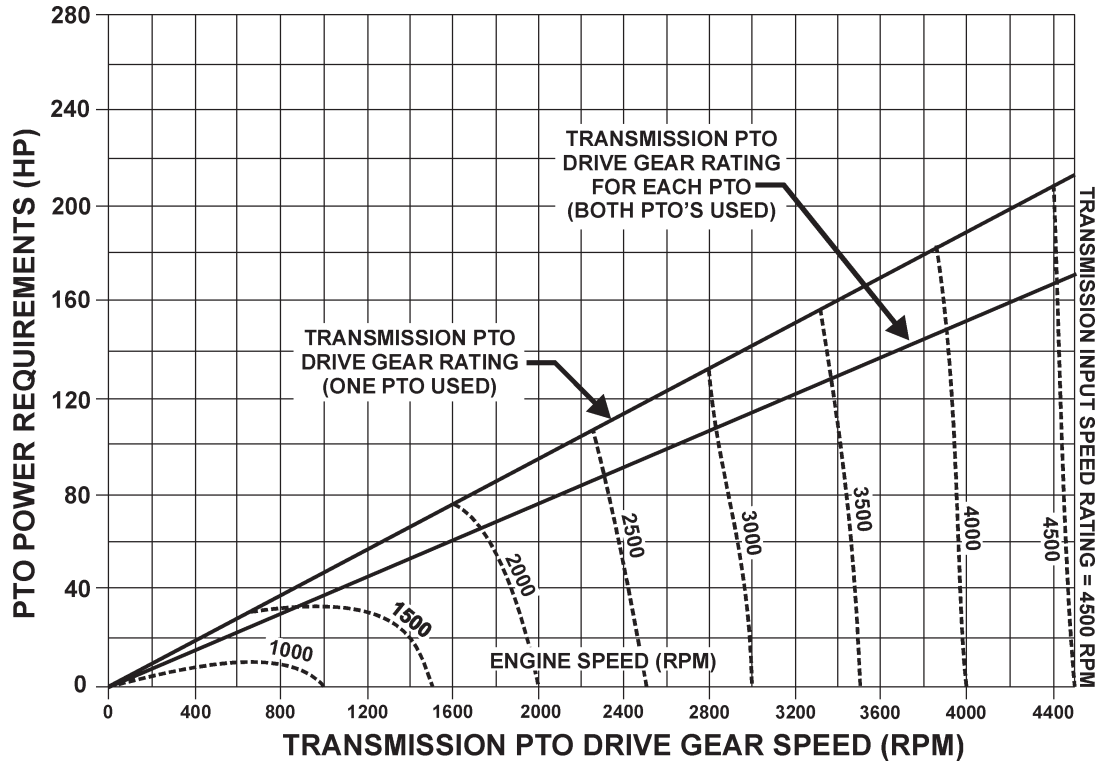

C025
A558

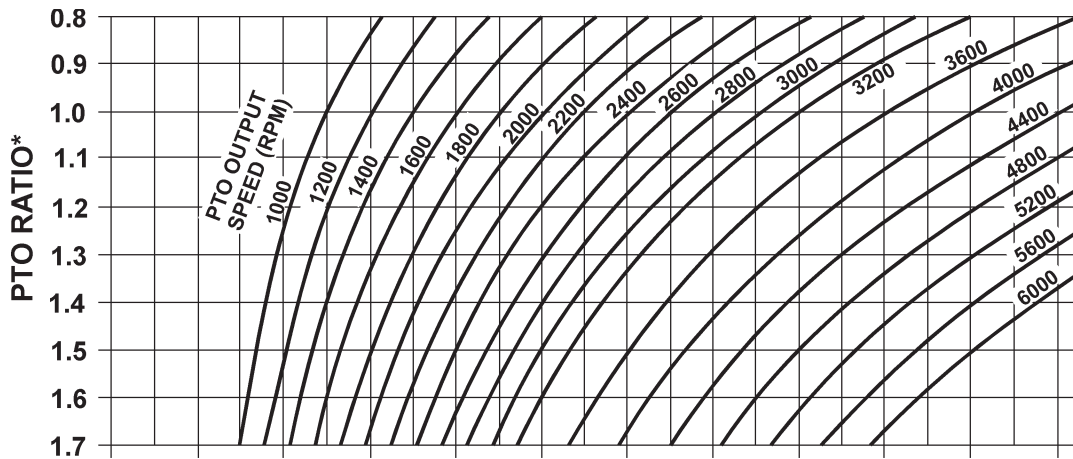

$$* \text{ PTO RATIO} = \frac{\text{PTO OUTPUT SPEED}}{\text{TRANSMISSION DRIVE GEAR SPEED}}$$

Figure B-1: PTO Performance Chart, U.S. Units — TC-210 Torque Converter

APPENDIX B – U.S. UNITS

Transmission Models: Allison 1000/2000 Product Families

Torque Converter Model: Allison TC-211

Transmission PTO Drive Gear Data

- Number of Teeth: 64
- Speed in Converter Mode: Less than Engine Speed
- Speed in Lockup Mode: Equal to Engine Speed
- Rating Using one PTO: 250 lb-ft maximum continuous
- Rating Using two PTO's simultaneously: 200 lb-ft maximum continuous for each PTO

C026
A558

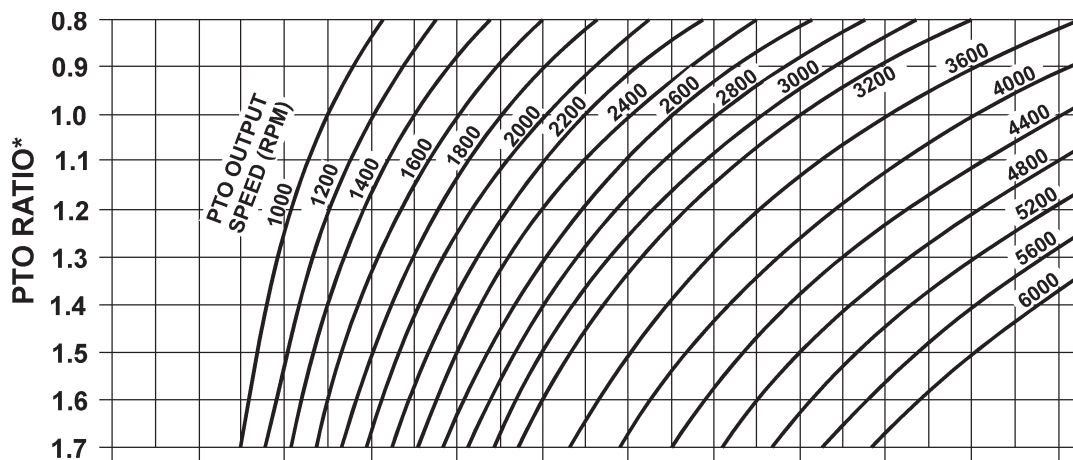
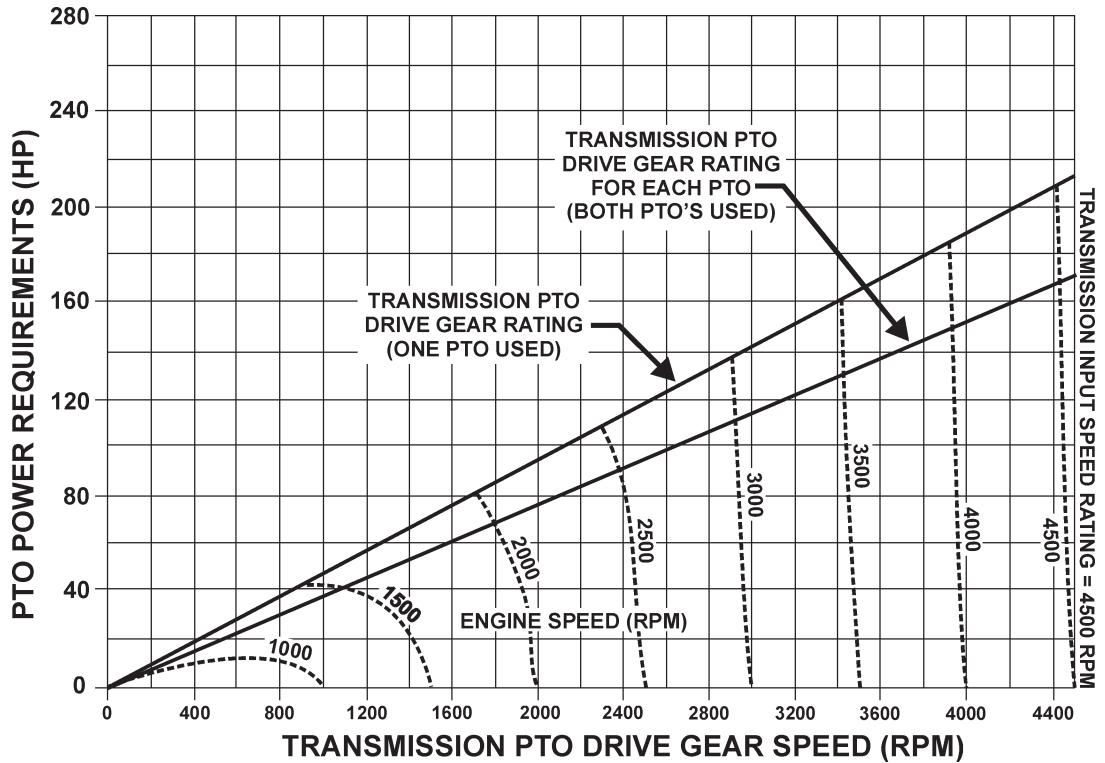

$$* \text{ PTO RATIO} = \frac{\text{PTO OUTPUT SPEED}}{\text{TRANSMISSION DRIVE GEAR SPEED}}$$

Figure B-2: PTO Performance Chart, U.S. Units — TC-211 Torque Converter

APPENDIX B – U.S. UNITS

Transmission Models: Allison 1000/2000 Product Families

Torque Converter Model: Allison TC-221

Transmission PTO Drive Gear Data

- Number of Teeth: 64
- Speed in Converter Mode: Less than Engine Speed
- Speed in Lockup Mode: Equal to Engine Speed
- Rating Using one PTO: 250 lb-ft maximum continuous
- Rating Using two PTO's simultaneously: 200 lb-ft maximum continuous for each PTO

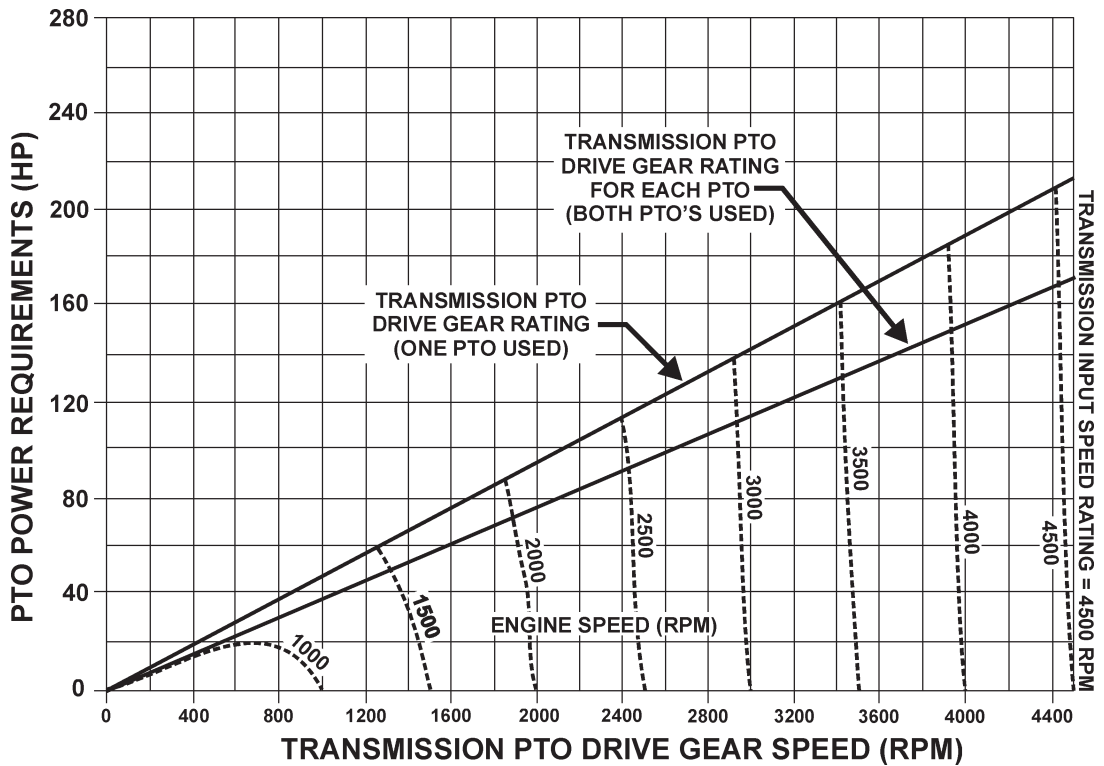

C027
A558

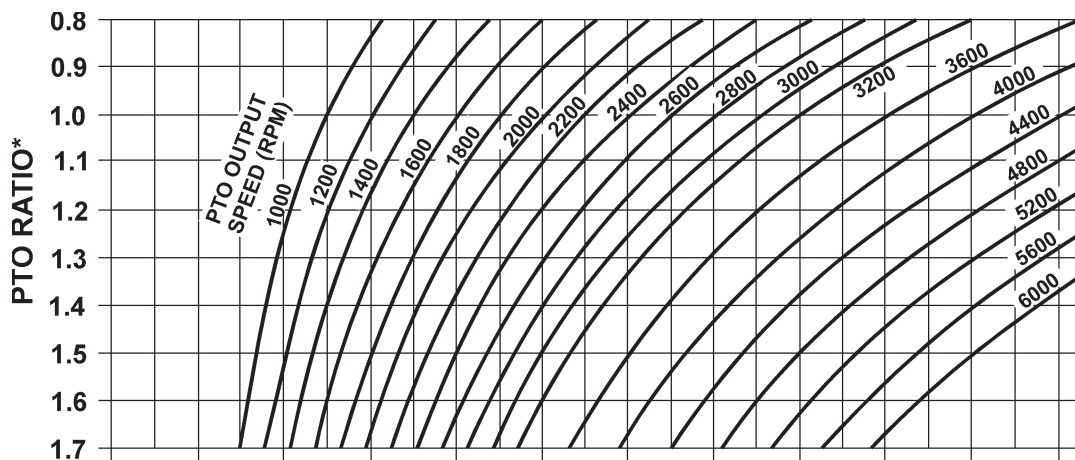

$$* \text{ PTO RATIO} = \frac{\text{PTO OUTPUT SPEED}}{\text{TRANSMISSION DRIVE GEAR SPEED}}$$

Figure B-3: PTO Performance Chart, U.S. Units — TC-221 Torque Converter

APPENDIX B – U.S. UNITS

Transmission Models: Allison 1000/2000 Product Families

Torque Converter Model: Allison TC-222

Transmission PTO Drive Gear Data

- Number of Teeth: 64
- Speed in Converter Mode: Less than Engine Speed
- Speed in Lockup Mode: Equal to Engine Speed
- Rating Using one PTO: 250 lb-ft maximum continuous
- Rating Using two PTO's simultaneously: 200 lb-ft maximum continuous for each PTO

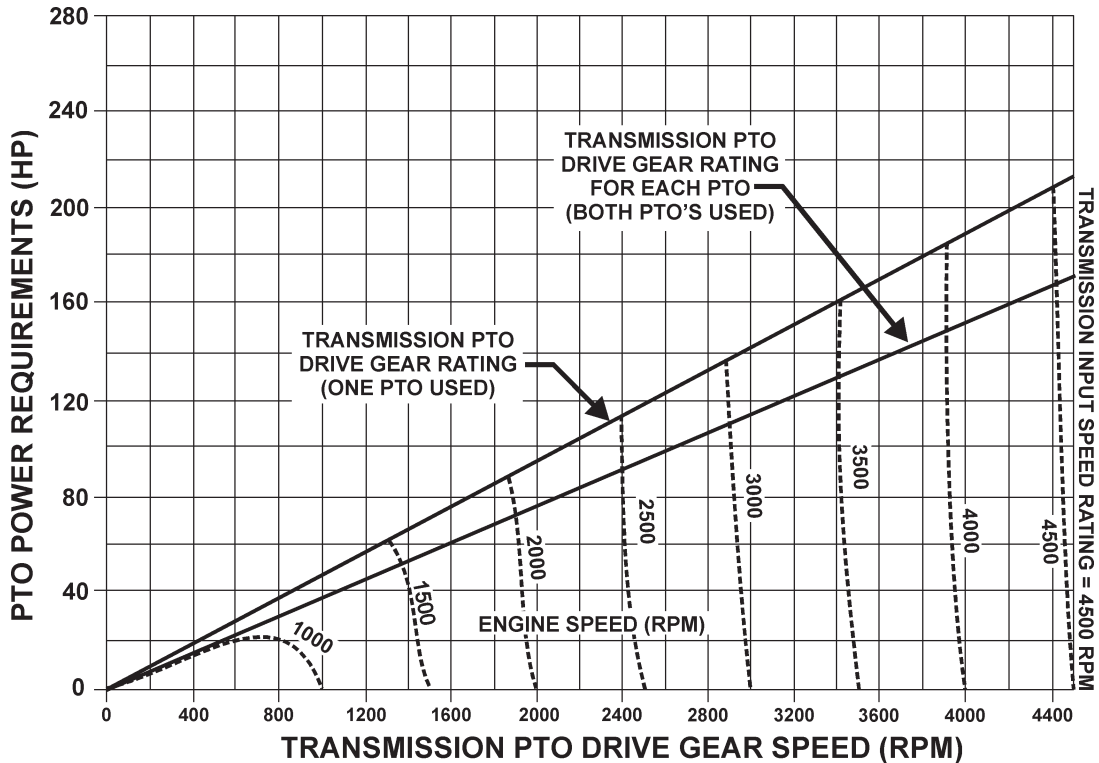

C028A
A558

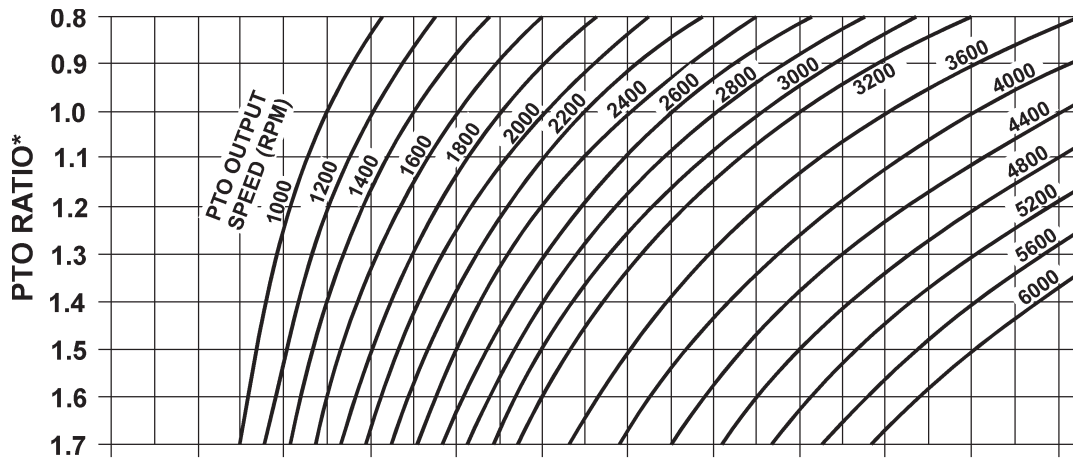

$$* \text{ PTO RATIO} = \frac{\text{PTO OUTPUT SPEED}}{\text{TRANSMISSION DRIVE GEAR SPEED}}$$

Figure B-4: PTO Performance Chart, U.S. Units — TC-222 Torque Converter

LIST OF REFERENCED DOCUMENTS

- [1000/2000 Product Family Features and Options](#)
- [1000/2000 Product Family Transmission Data](#)
- [Driveline Design – Basic](#)
- [Input/Output \(I/O\) Functions](#)
 - [PTO Drive Interface: Input C / Output G](#)
 - [Interface Function - Input CR / Output AN: Synchronized PTO Drive Interface for Mechanical Shift PTO](#)
- [Power Take-Off \(PTO\) – General System Design](#)
- [Section B: System Operation of the Allison 5th Generation Controls Manual](#)
- [Transmission Support Equipment](#)
- [Transmission-Mounted Power Take-Off \(PTO\) Installation Instructions for 1000/2000 Product Family](#)

1000/2000 Product Family Installation Drawings

- [AS64-401, Basic Installation Drawing, 1000 with SAE No. 3 \(1 Piece\) Converter Housing](#)
- [AS64-402, Basic Installation Drawing, SAE No. 3 \(2 Piece\) Converter Housing, 1000/2000](#)
- [AS64-403, Basic Installation Drawing, SAE No. 2 Converter Housing, 1000/2000](#)
- [AS64-480, Installation Drawing, PTO Provision for the 1000/2000 Product Family](#)

Technical Documents (TDs)

- [TD-176, Service Requirements – Removal and Replacement Times for Allison Transmissions](#)

REVISION HISTORY

March 6, 2015

- In 3.2, added information regarding the Synchronized PTO Drive Interface feature.

January 10, 2014

- Updated references and links to 5th Gen Controls.

August 13, 2010

- Updated references and links to Input/Output Functions.

July 17, 2008

- Prepared document for Extranet publication

June 11, 2008

- Created new document, *1000/2000 Product Family Power Take-Off (PTO) Design*