



Engine Parts

CATERPILLAR 3406

*Proven, reliable and
always innovative.*

TRP® offers reliable aftermarket engine products designed and tested to match both OEM parts performance and life as well as exceed customer expectations for quality and value.



OVERHAUL KITS • TURBOCHARGERS • CYLINDERS •
ENGINE COMPONENTS



Tested. Reliable. Guaranteed.

Caterpillar 3406 Engine Parts

Choosing the right replacement part or service for your vehicle—whether you own one, or a fleet—is one of the most important decisions you can make for your business. And, with tested TRP® parts it's an easy decision.

Regardless of the engine you use, TRP® quality replacement parts are engineered to fit. Choose the parts that give you the best value for your business. Check them out at an approved TRP® retailer near you.

The parts listed in this catalog are representative of the engine parts available, but not all inclusive of current and/or future offerings.

All manufacturers' names, numbers, symbols and descriptions are for reference only. It is not implied that any part is the product of the manufacturer. Caterpillar® and Cat® are registered trademarks for Caterpillar Inc.

The cross reference information in this catalog is based upon data provided by several industry sources and our partners. While every attempt is made to ensure the information presented is accurate, we bear no liability due to incorrect or incomplete information.

Product Availability

Due to export restrictions and market demands, not all products are always available in every location. Check for availability in your area with your local TRP® Distributor.

No part of this marketing material may be reproduced in any manner without written permission from TRP® North America.

TABLE OF CONTENTS

CATERPILLAR 3406 ENGINE PARTS

OVERHAUL KITS

- Inframe Kits 8
- Overhaul Kits 9

AIR MANAGEMENT COMPONENTS

- Turbochargers & Components 10
- Bolts 11
- Air Compressors & Components 12

COOLING SYSTEM COMPONENTS

- Thermostats & Components 13
- Water Pumps & Components 15

CRANKSHAFTS & COMPONENTS

- Crankshafts 17
- Crankshaft Parts 17
- Main Bearings 17
- Thrust Bearings 17
- Washers 18

TRP® North America

750 Houser Way N.
Renton, WA 98057

www.trpparts.com

CYLINDER COMPONENTS

Cylinder Packs & Kits	19
Cylinder Parts	20
Connecting Rod Bearings	20
Connecting Rods & Components	21
Connecting Rod Bearings	21
Bolts	22
Liners & Liner Components	22
Pistons & Components	23
Pins	24

CYLINDER HEADS & COMPONENTS

Cylinder Heads	25
Valve Train Parts	26
Valve Parts	27
Related Parts	27
Adapters	27
Main Bearings	28
Bolts	30
Grommets	30
Isolators	30
Nuts	30
Pins	30
Sleeve	30
Spacers	30
Springs	31
Studs	31
Washers	31

ENGINE BLOCKS & COMPONENTS

Engine Block Parts	32
Camshafts & Components	33
Oil Coolers & Components	34
Oil Pans & Components	34
Oil Lines & Components	35
Oil Pumps & Components	35

ENGINE BRAKES & COMPONENTS

Tune Up Kits	36
Exhaust Brakes	37
Engine Brake Components	37
Solenoids	38
Air Cylinders	38
Terminals	39

ENGINE FLYWHEELS

Flywheels	40
Flywheel Parts	40

FUEL SYSTEM COMPONENTS

Injector Assemblies	42
Injectors	42
Injector Parts	43
Fuel Pumps	45
Fuel Pump Parts	45
Related Parts	45
Washers	46
Hardware Kits	46

ENGINE PARTS

Tables76

Related Parts47

Adapters56

Bolts56

Grommets57

Isolators57

Locks57

Nozzles57

Nuts57

Pin/ Roller Kits57

Pins58

Plugs58

Sleeves58

Spacers58

Springs58

Studs58

Washers59

NATURAL GAS ENGINE COMPONENTS

Spark Plugs60

Hardware60

Washers60

CROSS REFERENCE

Cross Reference61

INDEXES & TABLES

Part Number Index67

Subject Index75

TRP[®] ENGINE PARTS

TRP[®] Aftermarket Parts for trucks, trailers and buses are available through a network of authorized retailers that include Kenworth, Peterbilt and DAF dealerships around the world. From dump trucks to cement mixers, delivery vans to tractor-trailers, school buses to transit buses of any age, TRP[®] offers reliable aftermarket products that are designed and tested to not only meet OEM specifications, but to exceed customers' expectations regardless of which major manufacturer makes their vehicles.

CONFIDENCE FOR THE ROAD AHEAD

Drivers and their vehicles — from trucks, trailers and buses — are constantly being tested. Whether it's the elements — the schedule — or the terrain, you must be prepared. The TRP[®] line of parts and service is engineered to withstand those tests — and exceed them.

TRP[®] is dedicated to providing the reliability that drivers demand out of their vehicles. It's the partnership between tough parts and the roads that test them. It's a focus on extending the life of your vehicle, no matter the make, so you can get the most out of your truck, trailer or bus.

What the TRP[®] logo means to you is confidence. Confidence that you're covered, no matter your make or vehicle. Confidence that the job will get done. And the confidence to take on whatever test may wait around the next turn.

DON'T SEE A PRODUCT YOU NEED?

Be sure to check with your local TRP®, Kenworth
or Peterbilt dealer for additional products,
pricing, and availability.

The TRP® Engine Parts Catalog contains information from
a variety of suppliers, including those listed below. All
brand-names, logos, images, information that came from
our suppliers and vendors are trademarked, registered and
property of that supplier.

TRP®

**American Power Source
Center Manufacturing, Inc.
Federal Mogul
Haldex
Illinois Auto Truck Co. Inc.
Interstate-McBee
Jacobs Vehicle Systems
PacBrake**

*To provide feedback on this TRP® Engine Parts Catalog,
please contact us at feedback@TRPParts.com.*

TRP® Engine Parts Catalog ©2013

*All manufacturers' names, symbols, and descriptions are for reference
only. It is not implied that any part is the product of these manufacturers.*

Caterpillar®, CAT® are registered trademarks of Caterpillar, Inc.

CATERPILLAR CHART

CATERPILLAR MODEL CHART AND SERIAL NUMBER LOCATION

SERIAL NUMBERS CONSIST OF A STRING OF ALPHANUMERIC CODE. THE SERIAL AND MODEL NUMBER IS LOCATED ON A METALLIC PLATE ON THE PASSENGER SIDE OF THE VALVE COVER. IF THE METALLIC PLATE IS MISSING, THE ENGINE SERIAL NUMBER IS STAMPED ON THE PASSENGER SIDE OF THE CYLINDER BLOCK, JUST BEHIND THE EXHAUST MANIFOLD.

PREFIXES FOR SELECTED CATERPILLAR ENGINE MODELS:

3406A	3406B	3406C	3406E	C15
3406A	3406B	3406C	3406E	C15
8SB	2EK	3ZJ	1LW	B5R
92U	3ZJ	4CK	1MM	BXS
	4CK	5KJ	2WS	JEP
	4MG		5DS	KRA
	5KJ		5EK	MHP
	5YG		6TS	MXS
	7FB			NXS
	8TC			RKS
				SDP
				TRB

PREFIXES FOR SELECTED CATERPILLAR REMANUFACTURED ENGINE MODELS:

3406A	3406B	3406C	3406E	C15
8SB	7XC		4AS	C2A

NOTE: Correct engine serial number and engine arrangement number are required for accurate parts identification.

OVERHAUL KITS

For all Inframe and Overhaul Kits and Parts, be sure to have your ESN available.

INFRAME KITS

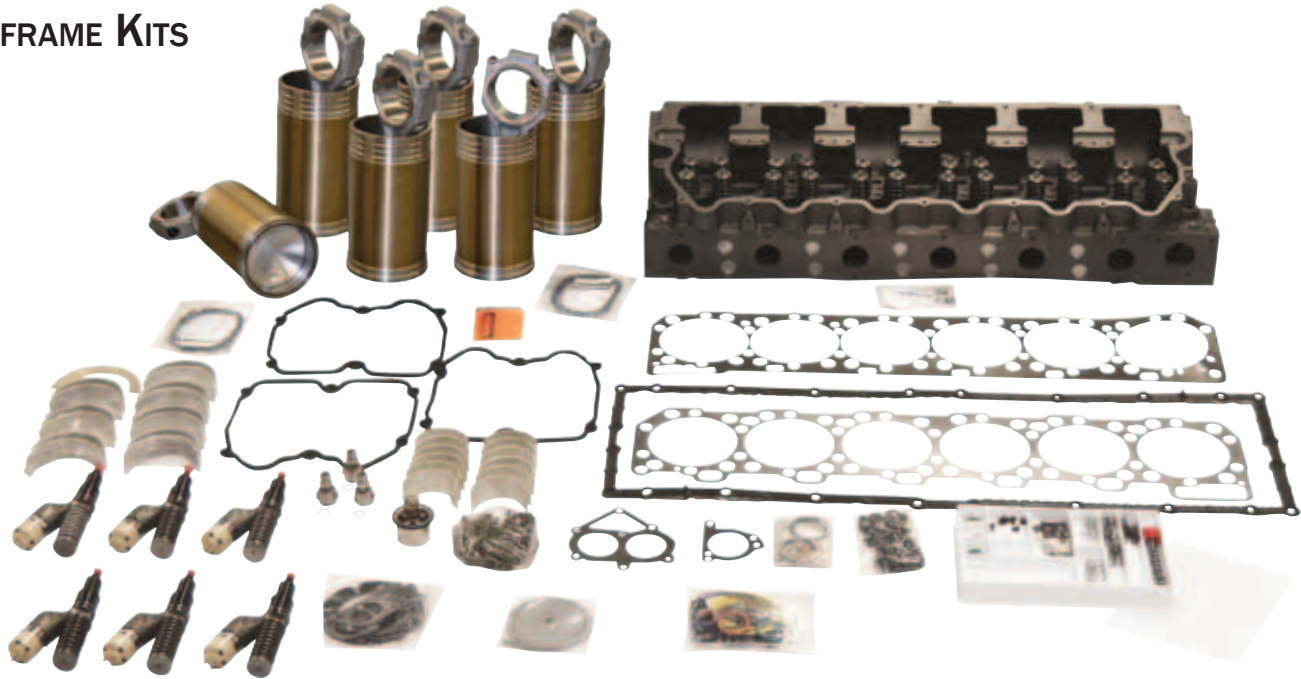

Table 1: Inframe Kits

Part No.	OEM No.	Description	UOM	Qty. Per Engine	SPQ	Comment
1495566MC1FCAT		Inframe Kit - 3406E	EA	1	1	2 PC articulated piston; steel crown & aluminum skirt; 16.25:1
3406BPMC1FCAT		Inframe Kit - Big Pin 3406	EA	1	1	
3406SPMC1FCAT		Inframe Kit - Small Pin 3406	EA	1	1	
1807352MC1FCAT		Inframe Kit - Cat 3406E	EA	1	1	

Table 2: Gaskets, Rings & Seals

Part No.	OEM No.	Description	UOM	Qty. Per Engine	SPQ
MC1F7C2888CAT		Inframe Overhaul Kit - 3406E 5EK	EA	1	1
3406062MCBCAT		Inframe Gasket Kit - Cat 3406B	EA	1	1

Part No.	OEM No.	Description	UOM	Qty. Per Engine	SPQ
3406462MCBCAT		Inframe Chassis Gasket Set - 3406E 5EK	EA	1	1

OVERHAUL KITS

Table 3: Overhaul Kits

Part No.	OEM No.	Description	UOM	Qty. Per Engine	SPQ
MC0H1807352		Overhaul Kit - 3406E	EA	1	1
MC0H3406BP		Complete Overhaul Kit - 3406	EA	1	1

AIR MANAGEMENT COMPONENTS

Quality Remanufactured Air Compressors, New and Remanufactured Turbochargers.

TURBOCHARGERS & COMPONENTS

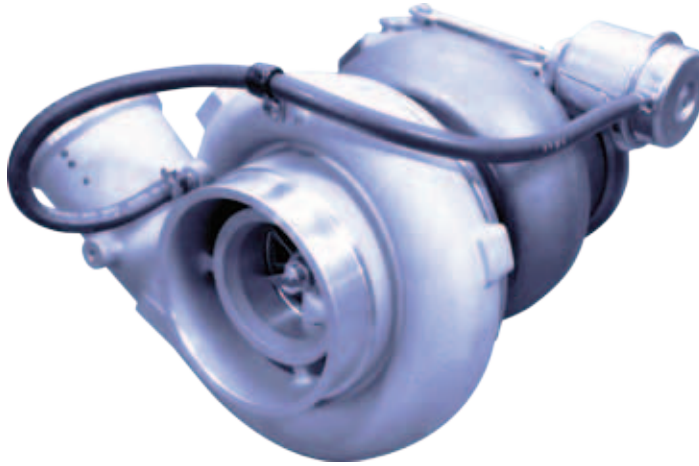

Table 4: Turbochargers - New

Part No.	OEM No.	Description	UOM	Qty. Per Engine	SPQ
1418938CAT	141-8938	New Turbocharger - Cat 3406E	EA	1	1

Table 5: Turbochargers - Reman

Part No.	OEM No.	Description	UOM	Qty. Per Engine	SPQ
OR7205TRP	471120-0001	Reman Turbocharger - Cat 3406E; Family BTG7508; 12 Fins On Compressor Side; 11 Fins On Turbine Side; Wastegate	EA	1	1
OR7579TRP	714508-0003	Reman Turbocharger - 3406E; Family GTA4294BS; 12 Fins On Compressor Side; 10 Fins On Turbine Side; Wastegate	EA	1	1

Table 6: Gaskets, Rings & Seals

Part No.	OEM No.	Description	UOM	Qty. Per Engine	SPQ
2746851CAT	2746851	Turbocharger Mounting Gasket	EA	1	1
1978418CAT	1978418	Turbocharger Lines Gasket - 0.1 lbs/ 0.04 kgs	EA	1	1

Part No.	OEM No.	Description	UOM	Qty. Per Engine	SPQ
1S4295CAT	1S4295	Turbocharger Mounting Gasket; 3406B (PEEC)	EA	1	1
19594JCB	19594	Turbocharger Gasket	EA	1	1
1S4810CAT	1S4810	Turbocharger Oil Line Drain Gasket - 0.1 lbs/ 0.04 kgs; 1-1/4" Dia.Center Hole	EA	1	1
1S6595CAT	1S6595	Turbocharger Oil Line Supply Gasket - 0.1 lbs/ 0.04 kgs; 3/4" Dia. Center Hole	EA	1	1
1978419CAT	1978419	Turbocharger Oil Line Gasket - End Item Identification: MRAP M-ATV; 0.1 lbs/ 0.04 kgs	EA	1	1

Table 7: Hardware

Part No.	OEM No.	Description	UOM	Qty. Per Engine	SPQ
BOLTS					
2N2765CAT	2N2765	Turbocharger Bolt - High Temp	EA	4	4

AIR COMPRESSORS & COMPONENTS



Image Courtesy of Bendix Commercial Vehicle Systems, LLC. All rights reserved.

Table 8: Air Compressors - Reman

Part No.	OEM No.	Description	UOM	Qty. Per Engine	SPQ
5002984BXR	5002984	Reman Air Compressor - TF 550; Rear End Cover Studs	EA	1	1
5002983BXR	5002983	Reman Air Compressor - TF 750	EA	1	1

Table 9: Gaskets, Rings & Seals

Part No.	OEM No.	Description	UOM	Qty. Per Engine	SPQ
1100004CAT	1100004	Air Compressor Ring Seal - 3126; 0.1 lbs/ 0.04 kgs	EA	1	1
1006178CAT	1006178	Air Compressor Mounting Gasket - 3406B/ C Engines	EA	1	1
1293948CAT	1293948	Integral Compressor Group Seal	EA	1	1
8M7065CAT	8M7065	Air Compressor Gasket	EA	1	1

COOLING SYSTEM COMPONENTS

Quality Thermostats and Water Pumps and their related parts.

THERMOSTATS & COMPONENTS



Table 10: Thermostat Kits

Part No.	OEM No.	Description	UOM	Qty. Per Engine	SPQ
7C3095KTCAT		Thermostat Kit	EA	1	1

Table 11: Thermostats - New

Part No.	OEM No.	Description	UOM	Qty. Per Engine	SPQ
1118010CAT	1118010	Thermostat - 175° F	EA	1	1
1193075CAT	1193075	Thermostat	EA	1	1
2485513CAT	2485513	Thermostat - 180° F	EA	1	1

Caterpillar 3406 Engine Parts

Table 12: Regulators

Part No.	OEM No.	Description	UOM	Qty. Per Engine	SPQ
2477133CAT	2477133	Temperature Regulator - 208°F	EA	1	1

Table 13: Sensors

Part No.	OEM No.	Description	UOM	Qty. Per Engine	SPQ
2644297CAT	2644297	Temperature Sensor	EA	1	1

Table 14: Gaskets, Rings & Seals

Part No.	OEM No.	Description	UOM	Qty. Per Engine	SPQ
3S9643CAT	3S9643	Thermostat Seal	EA	1	1
4N1156CAT	4N1156	Thermostat Housing Cover Gasket	EA	1	1
9Y2588CAT	9Y2588	Thermostat Housing Gasket - 5 Bolt; 3400; 0.1 lbs/ 0.04 kgs	EA	1	1
1393550CAT	1393550	Regulator Housing Gasket	EA	1	1

WATER PUMPS & COMPONENTS

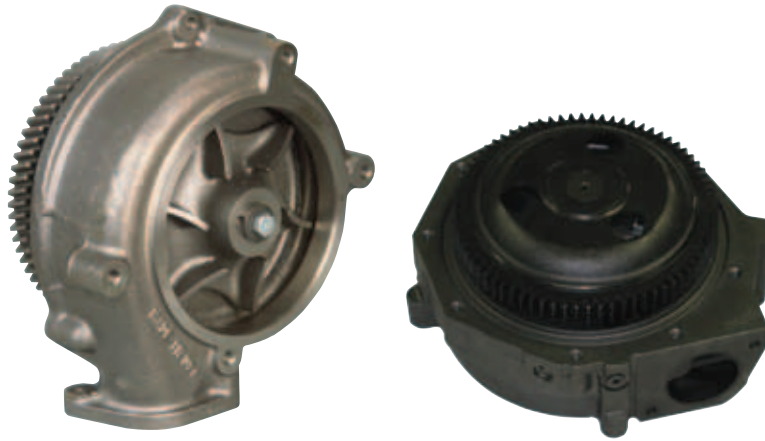

Table 15: Water Pumps - New

Part No.	OEM No.	Description	UOM	Qty. Per Engine	SPQ
1615719CAT	1615719	New Water Pump - fits 3406E & C15	EA	1	1
1025939CAT	1025939	New Water Pump - 3406A/ B	EA	1	1
1354925CAT	1354925	New Water Pump - 3406E	EA	1	1

Table 16: Water Pumps - Reman

Part No.	OEM No.	Description	UOM	Qty. Per Engine	SPQ
RW1194PXM1DRMAN	OR-8217	Reman Water Pump - 3406B, CAT 7C4957	EA	1	1
RW6012RXM1DRMAN	OR4120, OR8330, OR8218, 10R0483	Reman Water Pump - CAT 3406B/ C	EA	1	1
RW6012XM1DRMAN	OR4120, OR8330, OR8218, 10R0483	Reman Water Pump - 3406E	EA	1	1
RW6014XM1DRMAN		Reman Water Pump - Cat 3406E Straight Teeth	EA	1	1

Table 17: Adapters

Part No.	OEM No.	Description	UOM	Qty. Per Engine	SPQ
4P2383CAT	4P2383	Inlet Adapter - 3400 Cast Iron	EA	1	1
7C9222CAT	7C9222	Inlet Adapter - 3406 Aluminum	EA	1	1

Caterpillar 3406 Engine Parts

Table 18: Shafts

Part No.	OEM No.	Description	UOM	Qty. Per Engine	SPQ
1354928CAT	135-4928	Water Pump Shaft	EA	1	1

Table 19: Gaskets, Rings & Seals

Part No.	OEM No.	Description	UOM	Qty. Per Engine	SPQ	Comment
1250434CAT	1250434	Integral Water Lines Group Seal Gasket	EA	1	1	
1W2636CAT	1W2636	Water Pump Mounting Gasket - Late Style, 0.062" Thick	EA	1	1	
1280317CAT	1280317	Water Pump Group Seal	EA	1	1	
1282922CAT	128-2922	Water Pump Gasket Set - 0.4 lbs/ 0.18 kgs, 5" Length, 27mm Width, 27mm Depth, 11 Application: 3400	EA	1	1	Caterpillar Water Pump Installation Gasket Kit PN: 128-2922 - For use on C-9 MFF; 3406E 2WS; 3406C 3ZJ, 4CK, 8PN; 3406B all serials; 3406 92U
9M3786CAT	9M-3786	Water Pump O-Ring Seal	EA	1	1	
4W4014CAT	4W4014	Water Outlet Housing Gasket - 6 Bolt	EA	1	1	

CRANKSHAFTS & COMPONENTS

Quality new Crankshafts and related parts.

CRANKSHAFTS



Table 20: Crankshafts - Reman

Part No.	OEM No.	Description	UOM	Qty. Per Engine	SPQ
1368882CATR	1368882	Reman Crankshaft - Cat 3406E	EA	1	1
611453CAT	611453	Reman Crankshaft - 3406E Coreless	EA	1	1

CRANKSHAFT PARTS

Table 21: Dampers

Part No.	OEM No.	Description	UOM	Qty. Per Engine	SPQ
1678126CAT	1678126	Viscous Damper - 13.5" OD, 3406	EA	1	1

Table 22: Bearings

Part No.	OEM No.	Description	UOM	Qty. Per Engine	SPQ
----------	---------	-------------	-----	-----------------	-----

MAIN BEARINGS

2436718CAT	2436718	Main Bearing Kit - 3406	EA	1	1
4W5698CAT	4W5698	Main Bearing - 3400, 0.025" Undersize	EA	7	1
3215746CAT	3215746	Main Bearing - STD, G3 Spark Ignited Only	EA		1

THRUST BEARINGS

2531752CAT	2531752	Thrust Plate Bearing - STD	EA	2	1
------------	---------	----------------------------	----	---	---

Caterpillar 3406 Engine Parts

Table 23: Gaskets, Rings & Seals

Part No.	OEM No.	Description	UOM	Qty. Per Engine	SPQ	Comment
1425867CAT	1425867	Crankshaft Oil Seal Group Gasket - Front, 3400, 0.7 lbs/ 0.31 kgs; 1 PC Seal and Wear Sleeve Combo	EA	1	1	
1425868CAT	1425868	Crankshaft Oil Seal Group Gasket - Rear, 3400, 0.7 lbs/ 0.31 kgs, 17mm Length, 5" Width, 17mm Depth; Flanged Face Sleeve	EA	1	1	Caterpillar Rear Crankshaft Seal PN: 142-5868 - For use on 3406E 1LW; 3406E 1MM; 3406E 2WS 3406E 5DS; 3406E 5EK; 3406E 6TS; 3406C 5KJ; 3406C 8PN; 3406B 5KJ
2457339CAT	2457339	Crankshaft Seal - Front	EA	1	1	
7C1728CAT	7C1728	Crankshaft Seal Gasket - Rear, 1.7	EA	1	1	

Table 24: Hardware

Part No.	OEM No.	Description	UOM	Qty. Per Engine	SPQ
WASHERS					
1003652CAT	1003652	Thrust Plate Washer	EA	1	1

CYLINDER COMPONENTS

Quality Cylinder Components located in the Engine Block.

CYLINDER PACKS & KITS

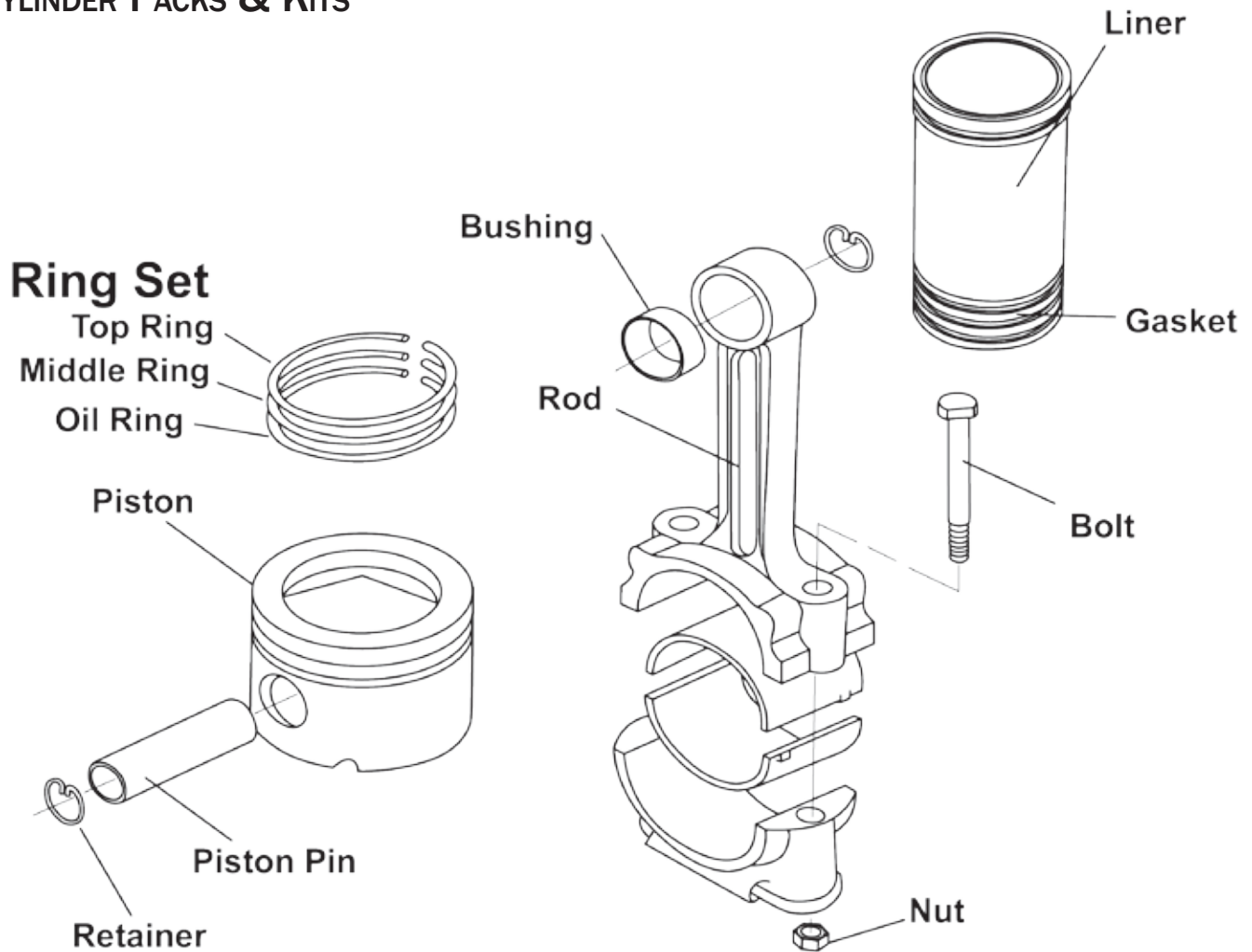

Table 25: Cylinder Kits

Part No.	OEM No.	Description	UOM	Qty. Per Engine	SPQ
CK2900017PCAT		Cylinder Kit - 3406	EA	6	1
CK1175063PCAT		Cylinder Kit - 3400, 1175063 Piston	EA	6	1

Caterpillar 3406 Engine Parts

Table 26: Cylinder Packs

Part No.	OEM No.	Description	UOM	Qty. Per Engine	SPQ
0R2694CATR*	0R2694	Cylinder Pack - 3406B 14.5:1 CR; DITA	KIT	6	1
0R2861CATR*	0R2861	Cylinder Pack - 3406B 15.2:1 CR, ATAAC, 350 - 425 HP	KIT	6	1
0R3757CATR*	0R3757	Cylinder Pack - Cat 3406C	KIT	6	1
0R4281CATR*	0R4281	Cylinder Pack - Cat 3406C; 15.6:1 CR	KIT	6	1
0R8320CATR*	0R8320	Cylinder Pack - 3406C, 16.0:1 CR	KIT	6	1
0R3782CATR*	0R3782	Cylinder Pack - 3406C, 15.2:1, 350 - 425 HP, 1991 & 1992 Engines	KIT	6	1
0R8333CATR*	0R8333	Cylinder Pack - 3406E, 16.25:1 CR, Articulated Piston With 1352837 (Crown) 130-0241 (Skirt)	KIT	6	1
0R8913CATR*	0R8913	Cylinder Pack - 3406E, 16.25:1 CR, Articulated Piston With 149-5566 (Crown) 130-0241 (Skirt)	KIT	6	1
0R8915CATR*	0R8915	Cylinder Pack - 3406E & C-15, 16.6:1 CR, Articulated Piston	KIT	6	1
0R9847CATR*	0R9847	Cylinder Pack - 3406C, 15.9:1 CR, Articulated Piston	KIT	6	1

* Pack contains: Liner; gasket set; piston; ring set; piston pin; pin bushing; retainers (2); connecting rod; dowel; bushing; bolts (2); nuts (2).

CYLINDER PARTS



Table 27: Bearings

Part No.	OEM No.	Description	UOM	Qty. Per Engine	SPQ
CONNECTING ROD BEARINGS					
9Y7735GCAT	9Y7735	Connecting Rod Bearing - STD, 3406B; Grooved; 1.9300" Length, 3.5425"/ 3.5441" Journal	EA	6	1
4W5702CAT	4W5702	Connecting Rod Bearing - 3400, 0.025" Oversized	EA	6	1

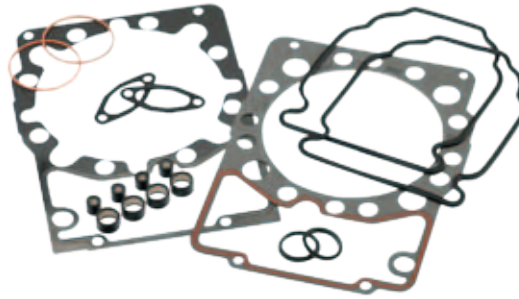

Table 28: Gaskets, Rings & Seals

Part No.	OEM No.	Description	UOM	Qty. Per Engine	SPQ	Comment
1W8922CAT	1W8922	Ring Set - 3400	EA	6	1	
1426217CAT	1426217	Cylinder Liner O-Ring Seal	EA	6	6	
1609874CAT	1609874	Single Cylinder Liner Gasket Set - 3406/ 3412 0.1 lbs/ 0.04 kgs	EA	1	1	Caterpillar Cylinder Liner Seal Kit - Single PN: 160-9874 - For use on 3406E 1LW; 3406E 2WS 3406E 5EK; 3406E 6TS; 3406C 3ZJ; 3406C 4CK; 3406C 5KJ; 3406C 8PN; 3406B 2EK; 3406B 3ZJ; 3406B 4CK; 3406B 4MG; 3406B 5KJ; 3406B 5YG; 3406B 7FB; 3406B 8TC
5P8768CAT	5P8768	Single Cylinder Liner Gasket Set	EA	6	1	
7W2398CAT	7W2398	Liner Gasket Group	EA		1	

CONNECTING RODS & COMPONENTS

Table 29: Bearings

Part No.	OEM No.	Description	UOM	Qty. Per Engine	SPQ
CONNECTING ROD BEARINGS					
2243246CAT	2243246	Connecting Rod Bearing - STD, C15	EA	6	1
9Y9497GCAT	9Y9497	Connecting Rod Bearing - STD, Grooved; Pair; 1.5350 Length; 3.8189/ 3.8197 Narrow Journal	EA	6	1

Caterpillar 3406 Engine Parts

Table 30: Bushings

Part No.	OEM No.	Description	UOM	Qty. Per Engine	SPQ
8N1985CAT	8N1985	Connecting Rod Bushing	EA	6	1

Table 31: Hardware

Part No.	OEM No.	Description	UOM	Qty. Per Engine	SPQ
BOLTS					
6N8942CAT	6N8942	Connecting Rod Bolt - 3400	EA	12	1
7E4195CAT	7E4195	Connecting Rod Bolt - C15, 3406	EA	12	1

LINERS & LINER COMPONENTS

Table 32: Liners

Part No.	OEM No.	Description	UOM	Qty. Per Engine	SPQ
1979322CAT	1979322	Cylinder Block Liner - 3400, 5.4 Bore	EA	6	1
1979322TRP	1979322	Cylinder Block Liner - 5.4 Bore	EA	6	1

Table 33: Inserts

Part No.	OEM No.	Description	UOM	Qty. Per Engine	SPQ
2W3815CAT	2W3815	Cylinder Liner Insert - 0.0632"	EA	A/R	1
9Y3368CAT	9Y3368	Cylinder Liner Insert - 0.032"	EA	A/R	1

Note: A/R = As Required

Table 34: Gaskets, Rings & Seals

Part No.	OEM No.	Description	UOM	Qty. Per Engine	SPQ	Comment
9L5854CAT	9L5854	Cylinder Liner Band - 3400; Upper Band Seal	EA	6	6	1 Per Liner

Part No.	OEM No.	Description	UOM	Qty. Per Engine	SPQ	Comment
1105800CAT	1105800	Cylinder Liner - 4.75 Bore	EA	6	1	
1102220CAT	1102220	Cylinder Liner O-Ring Seal - Lower Seal	EA	6	1	
1043560CAT	1043560	Liner Seal	EA	6	1	
1427072CAT	1427072	Cylinder Liner O-Ring Seal - 140.2mm ID; Coolant Seal	EA	6	6	

PISTONS & COMPONENTS

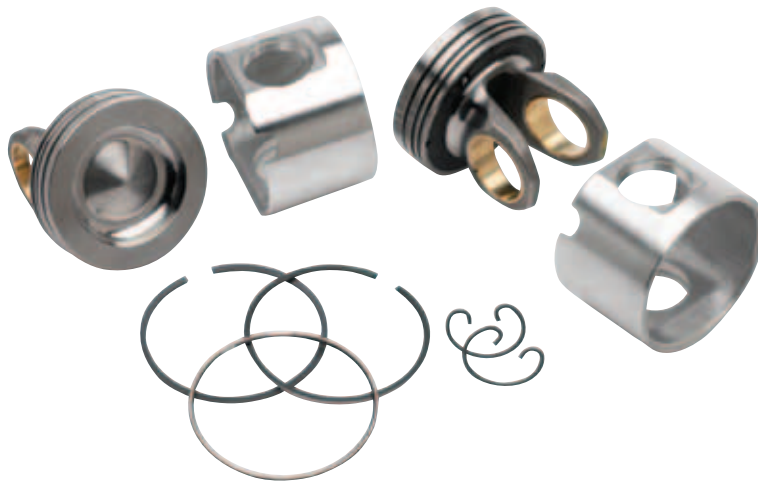

Table 35: Piston Kits

Part No.	OEM No.	Description	UOM	Qty. Per Engine	SPQ
CK1807352PCAT		Cylinder/ Piston Kit	EA	1	1

Table 36: Pistons

Part No.	OEM No.	Description	UOM	Qty. Per Engine	SPQ
7E292CAT	7E292	Piston - 3400, 1 PC Aluminum Piston	EA	1	1
9Y7212CAT	9Y7212	Piston - w/o Pin, 3400, 1 PC Aluminum Piston	EA	6	1
9Y9889CAT	9Y9889	Piston - w/o Pin, 1 PC Aluminum Piston	EA	1	1

Caterpillar 3406 Engine Parts

Table 37: Crowns

Part No.	OEM No.	Description	UOM	Qty. Per Engine	SPQ
1807352CAT	1807352	Piston Crown - C15, 2.165" Pin; 2 PC Articulated Steel Crown, Open Crown Gallery; 16.25:1 CR	EA	6	1

Table 38: Skirts

Part No.	OEM No.	Description	UOM	Qty. Per Engine	SPQ	Comment
1326663CAT	1326663	Piston Skirt - C15, 3406	EA	6	1	Skirt used with Crowns 1807351 & 1807352

Table 39: Gaskets, Rings & Seals

Part No.	OEM No.	Description	UOM	Qty. Per Engine	SPQ
MRS3406E2CAT		Ring Set - 3406E	EA	6	1
7N7078CAT	7N7078	Piston Oil Control Ring - 3400	EA	6	1
1343761CAT	1343761	Piston Ring - Top, 3406E	EA	6	1
2P2817CAT	2P2817	Piston Ring - Intermediate, 3400	EA	6	1
1765749CAT	1765749	Piston Ring - Intermediate, 3406E	EA	6	1
1899771CAT	189-9771	Oil Control Piston Ring - Intermediate, 3406E/ C15	EA	6	1

Table 40: Hardware

Part No.	OEM No.	Description	UOM	Qty. Per Engine	SPQ	Comment
PINS						
8N1608CAT	8N1608	Piston Pin - 3400	EA	1	1	
1687246CAT	1687246	Piston Pin	EA	6	1	
7E1177CAT	7E1177	Piston Retainer Pin - 3406E	EA	12	2	Use With 2.165 Pin Diameter
7E1177CAT	7E1177	Piston Retainer Pin - 3406E	EA	12	2	
7E5665CAT	7E5665	Piston Retainer Pin - 3400	EA	12	2	Use With 2.000 Pin Diameter

CYLINDER HEADS & COMPONENTS

Quality Parts Related Specifically to the Cylinder Heads.

CYLINDER HEADS

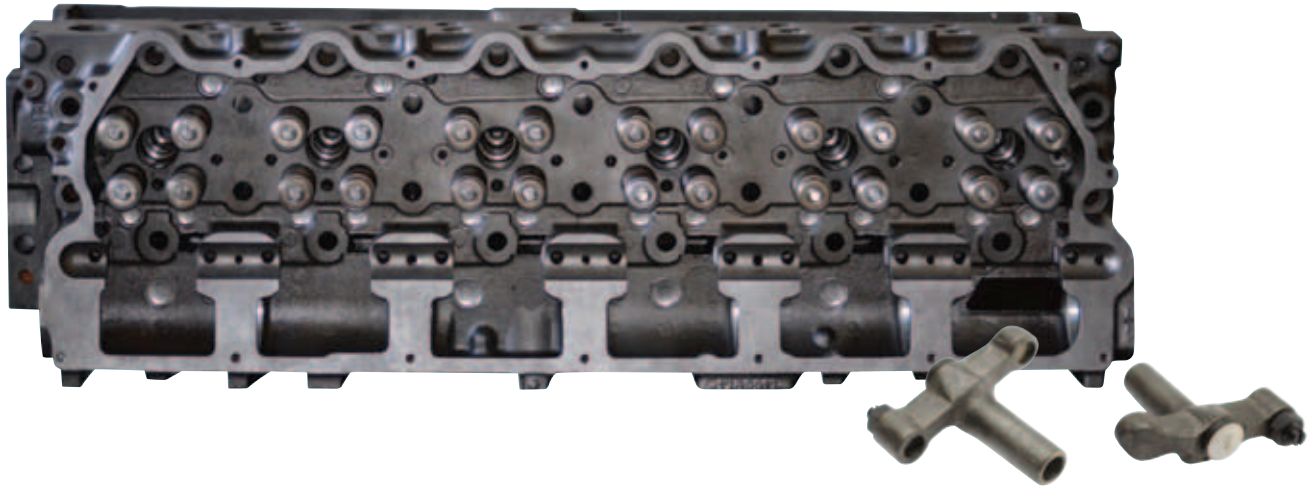

Table 41: Cylinder Heads - Reman

Part No.	OEM No.	Description	UOM	Qty. Per Engine	SPQ
0R3674CATR	0R-3674	Reman Cylinder Head - Cat 3406B	EA	1	1
0R9375CATR	0R-9375	Reman Cylinder Head - Cat 3408	EA	1	1
10R5984BRCATR	10R-5984	Reman Cylinder Head- w/ Bridges; 3406E (prefixes-1LW, 5EK, 6TS)	EA	1	1
10R5985BRCATR	10R-5985	Reman Cylinder Head- w/ Bridges; 3406E (prefixes 1LW, 1MM, 2WS, 5DS, 5EK, 6TS)	EA	1	1
10R4359BRCATR	10R4359BR	Reman Cylinder Head - Cat C15, w/ Bridges	EA	1	1

VALVE TRAIN PARTS



Table 42: Intake Valves

Part No.	OEM No.	Description	UOM	Qty. Per Engine	SPQ
1152368CAT	1152368	Intake Valve - 3400	EA	6	6

Table 43: Exhaust Valves

Part No.	OEM No.	Description	UOM	Qty. Per Engine	SPQ
1152367CAT	1152367	Exhaust Valve - 3400	EA	6	6

Table 44: Inserts

Part No.	OEM No.	Description	UOM	Qty. Per Engine	SPQ
4N5893CAT	4N5893	Valve Intake Insert - 3400	EA	6	6

Table 45: Valve Guides

Part No.	OEM No.	Description	UOM	Qty. Per Engine	SPQ
1227375CAT	1227375	Intake & Exhaust Valve Guide	EA	24	24
1W5283CAT	1W5283	Valve Exhaust Insert - STD	EA	12	6



Table 46: Gaskets, Rings & Seals

Part No.	OEM No.	Description	UOM	Qty. Per Engine	SPQ
1632478CAT	1632478	Valve Stem Seal	EA	24	6

Table 47: Hardware

Part No.	OEM No.	Description	UOM	Qty. Per Engine	SPQ
1031800CAT	1031800	Rotocoil Assembly	EA	12	1

VALVE PARTS

2A4429CAT	2A4429	Valve Lock	EA	48	12
2038822PRCAT	2038822PR	Pin & Roller Valve Kit - 3406E	EA	1	1

RELATED PARTS

Table 48: Adapters

Part No.	OEM No.	Description	UOM	Qty. Per Engine	SPQ
----------	---------	-------------	-----	-----------------	-----

ADAPTERS

1006920CAT	1006920	Cylinder Head Nozzle Adapter - 3400DI, Uses 8M5429 O-Ring & 4N7253 Gasket	EA	6	1
------------	---------	---	----	---	---

Caterpillar 3406 Engine Parts

Table 49: Bearings

Part No.	OEM No.	Description	UOM	Qty. Per Engine	SPQ
MAIN BEARINGS					
3178766CAT	3178766	Main Bearing - STD, 3400	EA	6	1



Table 50: Tappets

Part No.	OEM No.	Description	UOM	Qty. Per Engine	SPQ
1017788CAT	1017788	Tappet Assembly - 3400	EA	12	1

Table 51: Gaskets, Rings & Seals

Part No.	OEM No.	Description	UOM	Qty. Per Engine	SPQ	Comment
2N8204CAT	2N8204	Intake Manifold Gasket - 3400	EA	6	1	
2S3770CAT	2S3770	Exhaust Manifold Spacer - 11mm x 19mm x 33.5mm Thick	EA	1	1	
1384611CAT	1384611	Exhaust Manifold Gasket - Round Port, 0.1 lbs/ 0.04 kgs, 3400	EA	6	1	2 Gaskets Required per Cylinder
1299452CAT	1299452	Exhaust Manifold Gasket - 3400	EA	6	1	2 Gaskets Required per Cylinder
MCBC15093CAT	MCBC15093	Cylinder Head Gasket Kit	EA	1	1	
1539653CAT	1539653	Cylinder Head Gasket - 3406E; ESN's: 1LW0001-00229; 2SW0001-0405; 5DS0001-00048; 6TS0001-20554; 5EK 0001-up	EA	1	1	

Part No.	OEM No.	Description	UOM	Qty. Per Engine	SPQ	Comment
2271204CAT	2271204	Cylinder Head Shim - 3406E	EA	1	1	
CB3406113CAT		Cylinder Head Gasket - 3406C, 19 Bolt	EA	1	1	
CB3406273CAT		Cylinder Head Gasket - 3406C, 24 Bolt	EA	1	1	
MCB3406463CAT		Cylinder Head Gasket Kit - 3406E 5EK	EA	1	1	
MCB3406473CAT		Cylinder Head Gasket Kit - 3406E LLW 2WS 5DS 6T	EA	1	1	
2245122CAT	2245122	Cylinder Head Gasket - 3406E	EA	1	1	
2161252CAT	2161252	Single Cylinder Head Gasket Set - 3406/ 3406E	EA	1	1	
2902060CAT	2902060	Single Cylinder Head Gasket Set - 3400	EA	1	1	
1464229CAT	1464229	Single Cylinder Head Gasket Set - 3406B 4MG	EA	1	1	
2326652CAT	2326652	Single Cylinder Head Gasket Set - 3406B 7FB	EA	1	1	
CB399014CAT	CB399014	Single Cylinder Head Gasket Set	EA	1	1	
2486744CAT	2486744	Single Cylinder Head Gasket Set - 5.6 lbs/ 2.54 kgs, For Use On C-9 MFF; 3406E 1LW; 3406E 1mm, 3406E 2WS; 3406E 5DS; 3406E 6TS	EA	1	1	
2429537CAT	2429537	Rocker Cover Seal	EA	3	1	
5P5678-30CAT	5P5678-30	Valve Cover Seal - 1 Bag = 30 Meters	EA	3	30	9 Meters required when equipped with Jake Brake



Table 52: Hardware

Part No.	OEM No.	Description	UOM	Qty. Per Engine	SPQ	Comment
BOLTS						
1D4595CAT	1D4595	Cylinder Head Bolt - 152.0mm Long x 12.22mm Head Height	EA		1	
2H3750CAT	2H3750	Cylinder Head Bolt - 3400	EA	20	1	
0S1594CAT	0S1594	General Usage Bolt	EA	VARIES	10	
GROMMETS						
3E6772CAT	3E6772	Cylinder Head Water Grommet	EA	24	12	
ISOLATORS						
7C8296CAT	7C8296	Isolator	EA	VARIES	6	
NUTS						
2N2766CAT	2N2766	Exhaust Manifold Lock Nut	EA	12	12	
PINS						
1S5440CAT	1S5440	Dowel Pin	EA	1	1	
SLEEVE						
2818261CAT	2818261	Exhaust Sleeve Assembly - Exhaust Manifold to Cylinder Head, C15, 3406E	EA	6	1	
SPACERS						
1064159CAT	1064159	Exhaust Manifold Spacer - 11.13mm ID x 19.05mm OD x 13.5-mm Thick	EA	VARIES	1	
1083612CAT	1083612	Exhaust Manifold Spacer - 11.13mm ID x 19.05mm OD x 53-mm Thick	EA	VARIES	1	
7W7488CAT	7W7488	Valve Spring Spacer - 3300	EA	12	2	

Part No.	OEM No.	Description	UOM	Qty. Per Engine	SPQ	Comment
SPRINGS						
3056843CAT	3056843	Guide Lifter Spring - 3400	EA	1	1	
7S7144CAT	7S7144	Intake/ Exhaust Valve Spring	EA	2	2	
STUDS						
1061793CAT	1061793	Exhaust Manifold Stud - Taperlock; 3406E	EA	1	1	
4S6137CAT	4S6137	Cylinder Head Exhaust Manifold Taperlock Stud - 0.1 lbs/ 0.04 kgs, 3/8" x 3.1"	EA	5	5	
1061792CAT	1061792	Exhaust Manifold Stud - 3406E	EA	6	6	
6L8562CAT	6L8562	Cylinder Head Exhaust Manifold Stud - 0.1 lbs/ 0.04 kgs, 3/8" x 1-3/4"	EA	1	1	
MCB3406ESKCAT		Exhaust Manifold Stud Kit - 3406E	EA	1	1	Contains Nuts and Studs
MCB3406SKCAT		Exhaust Manifold Stud Kit - 3406B	EA	1	1	
WASHERS						
3H7654CAT	3H7654	Cylinder Head Washer - Steel, 13.5mm x 22.0mm x 3.2mm Thick	EA	6	6	
5M2894CAT	5M2894	Exhaust Manifold Washer - Steel, 22/32" OD x 13/32" ID X 0.109" Thick	EA	4	4	
8M7145CAT	8M7145	Exhaust Manifold Washer- 1/14" OD x 13.32" ID x 3/16" Thick	EA	6	6	
5H1504CAT	5H1504	Head Bolt Hard Washer	EA	VARIABLES	6	

ENGINE BLOCKS & COMPONENTS

Quality Engine Block parts including Camshafts, Pistons and Oil Coolers.

ENGINE BLOCK PARTS

Table 53: Plates

Part No.	OEM No.	Description	UOM	Qty. Per Engine	SPQ
614421CAT	614421	Spacer Plate	EA		1
612981CAT	612981	Cylinder Block Plate - Steel, 3406B/ C	EA	1	1

Table 54: Plugs

Part No.	OEM No.	Description	UOM	Qty. Per Engine	SPQ
1656170CAT	1656170	Plug - 3400	EA	VARIES	1

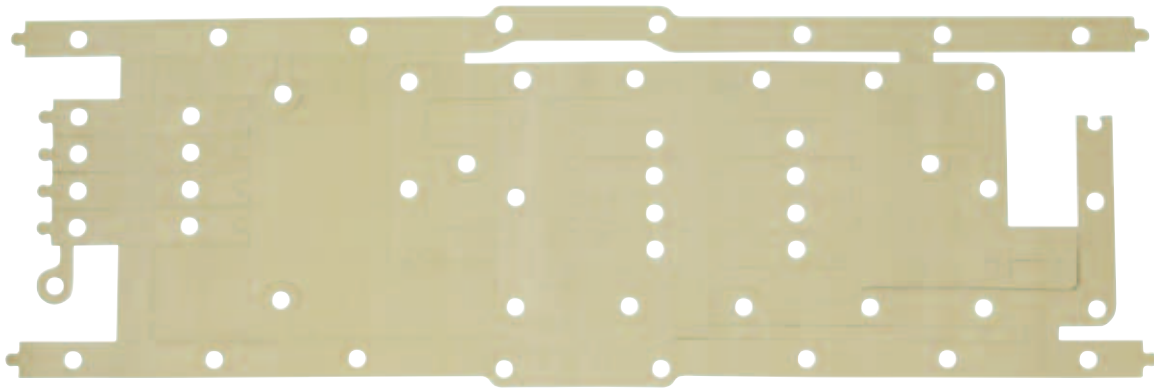

Table 55: Gaskets, Rings & Seals

Part No.	OEM No.	Description	UOM	Qty. Per Engine	SPQ	Comment
4Y9652CAT	4Y9652	Cylinder Block Cover Gasket	EA	1	1	
1422329CAT	1422329	Drainback Seal - 3406E	EA	1	1	
1685248CAT	1685248	Isolation Seal Gasket	EA	1	1	
4N1151-6CAT	4N1151-6	Oil Pan Gasket- 1 PC	EA	1	1	2 gaskets are required with pan spacer plate

Part No.	OEM No.	Description	UOM	Qty. Per Engine	SPQ	Comment
4N1151CAT	4N1151	Oil Pan Gasket - 3400, Puzzle style	EA	1	1	2 gaskets required with pan spacer plate
1661781CAT	1661781	Housing Cover Gasket - Front	EA	1	1	
1669144CAT	1669144	Housing Gasket - Front, 3406E	EA	1	1	

CAMSHAFTS & COMPONENTS



Table 56: Camshafts - Reman

Part No.	OEM No.	Description	UOM	Qty. Per Engine	SPQ
0R7653CATR	0R7653	Reman Camshaft - Cat 3406E - For Use on 3406E 5EK; 3406E 6TS	EA	1	1
10R3292CATR	10R3292	Reman Camshaft - Cat 3406E - For Use on 3406E 1LW; 3406E 1mm, 3406E 2WS 3406E 5DS	EA	1	1
10R7155CATR	10R7155	Reman Camshaft - Cat 3406E	EA	1	1
1310510CATR	1310510	Reman Camshaft - Cat 3406, 14.6L	EA	1	1
1365716CATR	1365716	Reman Camshaft - Cat 3306C	EA	1	1
4W2430CATR	4W2430	Reman Camshaft - Cat 3406A	EA	1	1

Table 57: Bushings

Part No.	OEM No.	Description	UOM	Qty. Per Engine	SPQ
2165582CAT	2165582	Camshaft Bushing - STD, 3406E	EA		7
2170752CAT	2170752	Camshaft Bushing - 0.030" Oversized, 3400E	EA		7
2165583CAT	2165583	Camshaft Bushing	EA		1

Caterpillar 3406 Engine Parts

Table 58: Gaskets, Rings & Seals

Part No.	OEM No.	Description	UOM	Qty. Per Engine	SPQ
1036045CAT	1036045	Front Cover Seal	EA	1	1

OIL COOLERS & COMPONENTS

Table 59: Oil Coolers - New

Part No.	OEM No.	Description	UOM	Qty. Per Engine	SPQ
1330125CAT	1330125	Oil Cooler - 3406E/ C15	EA	1	1
7C3039CAT	7C3039	Oil Cooler - 3400	EA	1	1

Table 60: Gaskets, Rings & Seals

Part No.	OEM No.	Description	UOM	Qty. Per Engine	SPQ
1090077CAT	1090077	Oil Cooler Mount O-Ring Seal	EA	3	1
1415787CAT	1415787	Oil Cooler & Lines Gasket Set - 3400E	EA	1	1
4F7387CAT	4F7387	Oil Cooler O-Ring Seal - 100.97 x 5.33mm, Material - Nitrile Rubber	EA	1	1
1891814CAT	1891814	Oil Cooler & Lines Gasket Set - 3400	EA	1	1

OIL PANS & COMPONENTS

Table 61: Dipsticks

Part No.	OEM No.	Description	UOM	Qty. Per Engine	SPQ
40764-20	40764-20	Dipstick Assembly - 84" Long x 1" Handle x 1/4" Blade	EA	1	1

Table 62: Filler Caps

Part No.	OEM No.	Description	UOM	Qty. Per Engine	SPQ
6N2985CAT	6N2985	Oil Filler Cap - 1-7/8"	EA	1	1
44165-201	44165-201	Oil Filler Cap - 1-1/2"	EA	1	1
44209-20	44209-20	Oil Filler Cap - 1-3/8"	EA	1	1
44098-201	44098-201	Oil Filler Cap - 2"	EA	1	1

Table 63: Gaskets, Rings & Seals

Part No.	OEM No.	Description	UOM	Qty. Per Engine	SPQ
M4N1151-6CAT		Oil Pan Gasket - 1 PC, 3400 Series	EA		1
2A3398CAT	2A3398	Oil Pan Drain Plug Gasket - Multiple Applications	EA	1	1

OIL LINES & COMPONENTS

Table 64: Gaskets, Rings & Seals

Part No.	OEM No.	Description	UOM	Qty. Per Engine	SPQ
1090072CAT	1090072	Engine Oil Line Tube O-Ring Seal	EA		6
9M4849CAT	9M-4849	Engine Oil Lines Group O-Ring Seal - 23.16 x 5.33mm, Material-Silicone Rubber	EA	20	6

OIL PUMPS & COMPONENTS

Table 65: Gaskets, Rings & Seals

Part No.	OEM No.	Description	UOM	Qty. Per Engine	SPQ
5P5846CAT	5P5846	Oil Pump Suction Tube O-Ring Seal Gasket - 0.1 lbs/ 0.04 kgs, Tubeviton (75) 40.64mm x 5.33mm	EA		1
5P8068CAT	5P8068	Oil Pump Suction Tube O-Ring Seal Gasket - 0.1 lbs/ 0.04 kgs, Tubeviton (75) 37.47mm x 5.33"	EA		6

ENGINE BRAKES & COMPONENTS

Quality Engine Brake Components for the Caterpillar 3406.

TUNE UP KITS

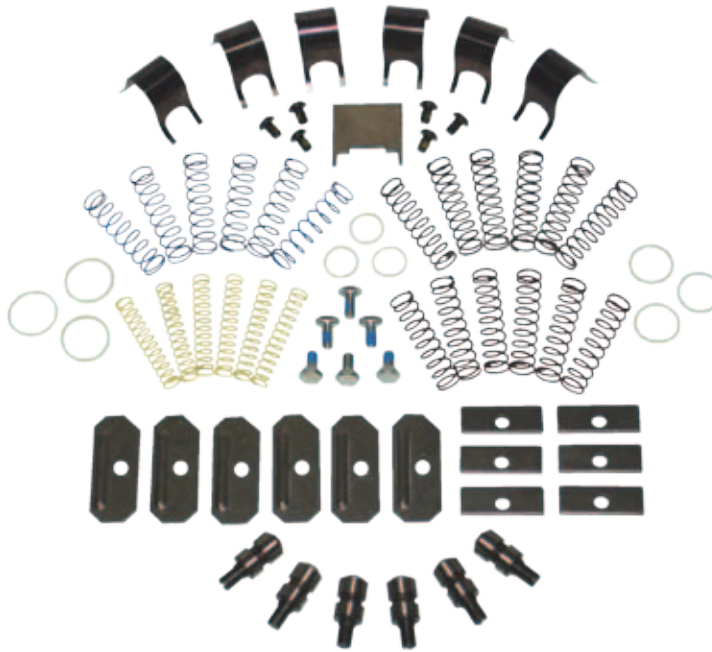

Table 66: Tune Up Kits

Part No.	OEM No.	Description	UOM	Qty. Per Engine	SPQ	Comment
14087JCB	14087	Tune Up Kit - 346 Series	KIT	1	1	Crosses To Pacbrake P34601
19461JCB	19461	Tune Up Kit - 349 Series	KIT	1	1	
19654JCB	19654	Tune Up Kit - 340 Series	EA	1	1	
P39010	P39010	Engine Brake Tune Up Kit	EA	1	1	

EXHAUST BRAKES

Table 67: Exhaust Brakes

Part No.	OEM No.	Description	UOM	Qty. Per Engine	SPQ
25223JCB	25223	Exhaust Brake Assembly - EX3126B	EA	1	1

ENGINE BRAKE COMPONENTS

Table 68: Housings

Part No.	OEM No.	Description	UOM	Qty. Per Engine	SPQ
1033020JCB	1033020	Housing Assembly - 12VDC D/L	EA	1	1

Table 69: Push Rods

Part No.	OEM No.	Description	UOM	Qty. Per Engine	SPQ
18233JCB	18233	Push Rod Slave Piston Assembly	KIT	1	1

Table 70: Switches

Part No.	OEM No.	Description	UOM	Qty. Per Engine	SPQ
12246JCB	12246	Clutch Switch	EA	1	1
12261JCB	12261	Clutch Switch Group	EA	1	1
18188JCB	18188	Switch	EA	1	1
19229JCB	19229	Extarder Assembly	EA	1	1
7671JCB	7671	Switch Assembly - Negative Ground	EA	1	1

Caterpillar 3406 Engine Parts

Table 71: Gaskets, Rings & Seals

Part No.	OEM No.	Description	UOM	Qty. Per Engine	SPQ
20229JCB	20229	Upper Ring Seal	EA	1	1
1082JCB	1082	Center Ring Seal	EA	1	1
1083JCB	1083	Lower Ring Seal	EA	1	1
19590JCB	143-6505	Extarder Gasket - Model EX83	EA	1	1
2411JCB	2411	O-Ring - 0.365" ID x 0.07" W	EA	1	1

SOLENOIDS

Table 72: Solenoids

Part No.	OEM No.	Description	UOM	Qty. Per Engine	SPQ
1024610JCB	163-1533	Solenoid - 12VDC D/L H-Blade Package	EA	1	1
1024613JCB	1024613	Solenoid - 12VDC S/L H-Blade Package	EA	1	1
1024614JCB	163-1547	Solenoid - 12VDC S/L V-Blade Package	EA	1	1

AIR CYLINDERS

Table 73: Air Cylinders

Part No.	OEM No.	Description	UOM	Qty. Per Engine	SPQ
28343JCB	28343	Air Cylinder Replacement Group	EA	1	1

TERMINALS

Table 74: Terminals

Part No.	OEM No.	Description	UOM	Qty. Per Engine	SPQ
2299JCB	2299	Leadout Assembly Terminal	EA	1	1

ENGINE FLYWHEELS

Quality Engine Flywheels and related parts for the Caterpillar 3406.

FLYWHEELS



Table 75: Flywheels

Part No.	OEM No.	Description	UOM	Qty. Per Engine	SPQ
4P4797TRP	4P4797	Flywheel - 15", Cat 3406/ 3406E	EA	1	1

FLYWHEEL PARTS

Table 76: Gaskets, Rings & Seals

Part No.	OEM No.	Description	UOM	Qty. Per Engine	SPQ
1555619CAT	1555619	Flywheel Housing Gasket - 3406	EA	1	1



Table 77: Hardware

Part No.	OEM No.	Description	UOM	Qty. Per Engine	SPQ
5B0841TRP	5B0841	Flywheel Bolt	EA	12	6
9L7816CAT	9L7816	Flywheel Bolt	EA	1	1

FUEL SYSTEM COMPONENTS

Quality Fuel System Components for the Caterpillar 3406.

INJECTOR ASSEMBLIES

Table 78: Injector Assemblies

Part No.	OEM No.	Description	UOM	Qty. Per Engine	SPQ
1917941CAT	1917941	Fuel Injection Line Assembly (no. 1 cylinder) - 3406	EA	1	1
1917942CAT	1917942	Fuel Injection Line Assembly (no. 2 cylinder) - 3406	EA	1	1
1917943CAT	1917943	Fuel Injection Line Assembly (no. 3 cylinder) - 3406	EA	1	1
1917944CAT	1917944	Fuel Injection Line Assembly (no. 4 cylinder) - 3406	EA	1	1
1917945CAT	1917945	Fuel Injection Line Assembly (no. 5 cylinder) - 3406	EA	1	1
1917946CAT	1917946	Fuel Injection Line Assembly (no. 6 cylinder) - 3406	EA	1	1

INJECTORS



Table 79: Injectors - New

Part No.	OEM No.	Description	UOM	Qty. Per Engine	SPQ
8N7003CAT	8N7003	Fuel Injector	EA	1	1

Table 80: Injectors - Reman

Part No.	OEM No.	Description	UOM	Qty. Per Engine	SPQ
0R3421CATR	0R3421	Reman Fuel Nozzle Injector - 3406B - For Use On 3406C 5KJ; 3406B 4MG; 3406B 5KJ; 3406B 7FB	EA	6	1
0R3423CATR	0R3423	Reman Fuel Nozzle Injector - 3406B - For Use On 3406C 3ZJ; 3406C 5KJ; 3406B 4MG; 3406B 5KJ; 3406B 8TC	EA	6	1
0R3587CATR	0R3587	Reman Fuel Injector - 3406	EA	6	1
0R3588CATR	0R3588	Reman Fuel Injector, Pencil Nozzle - 3406B - For Use on 3406C 4CK; 3406B 2EK; 3406B 3ZJ; 3406B 4CK	EA	6	1
0R4337CATR	0R4337	Reman Fuel Injector - 3406C	EA	6	1
0R8289CATR	0R8289	Reman Fuel Injector - 7000 Series	EA	1	1
0R8783CATR	0R8783	Reman Fuel Injector - 3306C	EA	1	1
10R8501CATR	10R8501	Reman Fuel Injector Group	EA	1	1
10R8502CATR	10R8502	Reman Fuel Injector - 3406E/ C15/ C16	EA	6	1

Table 81: Injector Kits

Part No.	OEM No.	Description	UOM	Qty. Per Engine	SPQ
2075248PRCAT	2075248PR	Injector Pin & Roller Kit- 3406E	EA	6	1

INJECTOR PARTS

Table 82: Gaskets, Rings & Seals

Part No.	OEM No.	Description	UOM	Qty. Per Engine	SPQ	Comment
1048585CAT	1048585	Regulator Gasket - 3406	EA	1	1	
1198784CAT	1198784	Fuel Injector O-Ring	EA	6	1	
2303775CAT	2303775	Fuel Injector Group O-Ring Seal - C15, 3406E	EA	6	6	
9X7317CAT	9X7317	Fuel Injector O-Ring Seal - External, Lower Seal; C15, 3406E	EA	6	6	Center O-Ring on Injector
9X7430CAT	9X7430	Fuel Injector Sleeve O-Ring Seal - lower seal	EA	6	6	

Caterpillar 3406 Engine Parts

Part No.	OEM No.	Description	UOM	Qty. Per Engine	SPQ	Comment
1082102CAT	1082102	Fuel Injector Pump Bonnet	EA		1	
1663718CAT	1663718	Fuel Injector O-Ring Seal - Tube 3400, 0.1 lbs/ 0.04 kgs	EA	6	6	
2153198CAT	2153198	Fuel Injector Pump Group O-Ring Seal - External, Top Seal, C15/ 3406E	EA	6	6	
2373800CAT	2373800	Fuel Injector Pump Group O-Ring Seal - 0.1 lbs/ 0.04 kgs, 3126B & 3126E	EA	6	1	
3J1907CAT	3J1907	Fuel Injector O-Ring Seal - Liter Line	EA		12	
9X7418CAT	9X7418	Fuel Injector O-Ring Seal - External, Middle	EA	6	1	
9X7735CAT	9X7735	Fuel Injector O-Ring Seal - External, 3406C	EA	6	6	
9L9098CAT	9L9098	Fuel Injector Seal - Carbon Stop	EA	6	10	
9X7419CAT	9X7419	Fuel Injector O-Ring Seal - External, 3400; 36.09mm ID	EA	6	1	
2245797CAT	2245797	External Injector Seal Kit	EA	6	1	For 1 Injector, Kit Contains: (Top Seal), (Middle Seal), & (Lower Seal)
2481394CAT	2481394	External Injector Seal Kit - HEUI	EA	6	1	For 1 Injector, Kit Contains: (Top Seal), (Middle Seal), & (Lower Seal)

Table 83: Hardware

Part No.	OEM No.	Description	UOM	Qty. Per Engine	SPQ
8S9191CAT	8S9191	Injector Hold Down Bolt - 3/8" x 4"- C15, 3406E	EA	6	2
2274239CAT	2274239	Injector Sleeve - C15, 3406E	EA	6	1
9L6884CAT	9L6884	Fuel Nozzle Assembly - 3400	EA	1	1
4W7018CAT	4W7018	Fuel Nozzle - 3406B	EA	6	1

FUEL PUMPS

Table 84: Fuel Pumps

Part No.	OEM No.	Description	UOM	Qty. Per Engine	SPQ
1052508CAT	1052508	Fuel Priming Pump	EA	1	1
1375541CAT	1375541	Fuel Priming Pump - High Volume	EA	1	1

FUEL PUMP PARTS

Table 85: Bearings

Part No.	OEM No.	Description	UOM	Qty. Per Engine	SPQ
7M7219CAT	7M7219	Thrust Needle Bearing - 3406C	EA		5

Table 86: Gaskets, Rings & Seals

Part No.	OEM No.	Description	UOM	Qty. Per Engine	SPQ
8N5763CAT	8N5763	Fuel Group Seal	EA		1
1440480CAT	1440480	Governor Group Gasket - 3400	EA	1	1

RELATED PARTS

Table 87: Clamps

Part No.	OEM No.	Description	UOM	Qty. Per Engine	SPQ
1W9168CAT	1W9168	Fuel Line Clamp - 7/32" Dia, Non-Threaded	EA		1
1W9169CAT	1W9169	Fuel Line Clamp - 5/35" Dia, Threaded	EA		1

Caterpillar 3406 Engine Parts

Table 88: Gaskets, Rings & Seals

Part No.	OEM No.	Description	UOM	Qty. Per Engine	SPQ	Comment
4F9653CAT	4F-9653	Pre-Combustion Chamber O-Ring Seal - 46.99 x 5.33mm, Material - Nitrile Rubber	EA	6	6	
4N7253CAT	4N7253	Pre-Combustion Chamber Gasket	EA	6	1	
7S3206CAT	7S3206	Pre-Combustion Chamber O-Ring Seal	EA	6	2	
2303728CAT	2303728	Fuel Group O-Ring Seal	EA	1	1	
1P436CAT	1P436	Fuel Priming Pump Gasket	EA	VARIES	24	
1440482CAT	1440482	Fuel Pump Group Gasket - 3400E	EA		1	
1440481CAT	1440481	Fuel Pump Mounting Gasket - 3400	EA		1	
2974841CAT	2974841	Gasket-Set Single Fuel System	EA		1	
2421539CAT	2421539	Single Fuel O-Ring Kit	EA		1	
8H2778CAT	8H2778	Fuel Filter Gasket - 0.1 lbs/ 0.04 kgs	EA	1	1	

Table 89: Hardware

Part No.	OEM No.	Description	UOM	Qty. Per Engine	SPQ
WASHERS					
8H9204CAT	8H9204	Fuel Pump Felt Washer	EA	6	6
HARDWARE KITS					
8991004CAT	8991004	Solenoid Installation Kit - 3406E	EA	1	1

ENGINE PARTS

Quality Engine Parts for the Caterpillar 3406.

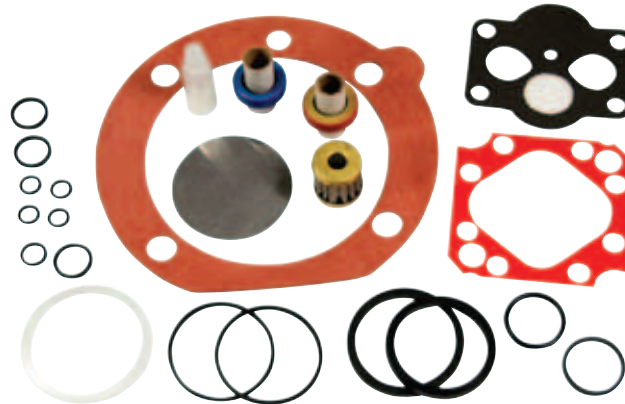

RELATED PARTS

Table 90: Gaskets, Rings & Seals

Part No.	OEM No.	Description	UOM	SPQ	Comment
0618561CAT	061-8561	O-Ring Seal - 40.87 x 3.53mm, Material - Fluorocarbon Rubber	EA	1	
1006178CAT	1006178	Air Compressor Mounting Gasket - 3406B/ C Engines	EA	1	
1013125CAT	1013125	Air Inlet Manifold Gasket	EA	1	
1036045CAT	1036045	Front Cover Seal	EA	1	
1043560CAT	1043560	Liner Seal	EA	1	
1048585CAT	1048585	Regulator Gasket - 3406	EA	1	
1075769CAT	1075769	O-Ring Seal - 79.38mm x 2.62mm	EA	1	
1076280CAT	107-6280	O-Ring Seal - 177.17 x 5.33mm, Material - Hydrogenated Nitrile	EA	1	
1082102CAT	1082102	Fuel Injector Pump Bonnet	EA	1	
1082JCB	1082	Center Ring Seal	EA	1	
1083JCB	1083	Lower Ring Seal	EA	1	
1090072CAT	1090072	Oil Line Tube O-Ring Seal	EA	6	
1090077CAT	1090077	Oil Cooler Mount O-Ring Seal	EA	1	
1090078CAT	1090078	O-Ring Seal - 37.47mm x 5.33mm	EA	6	
1095313CAT	1095313	Exhaust Gasket - Cat 3, 4 - Fabrication Method: Solid; OD: 89.44mm Nominal; Aperture Diameter: 47.00mm Nominal	EA	1	
1100004CAT	1100004	Air Compressor Ring Seal - 3126; 0.1 lbs/ 0.04 kgs	EA	1	
1102220CAT	1102220	Cylinder Liner O-Ring Seal - Lower Seal	EA	1	

Caterpillar 3406 Engine Parts

Part No.	OEM No.	Description	UOM	SPQ	Comment
1105800CAT	1105800	Cylinder Liner - 4.75 Bore	EA	1	
1125282CAT	112-5282	O-Ring Seal - 16.36 x 2.21mm, Material - Hydrogenated Nitrile	EA	1	
1142687CAT	1142687	O-Ring Seal - 23.16mm x 5.33mm	EA	1	
1144427CAT	1144427	O-Ring Seal - 19.181mm x 2.46mm	EA	6	
1171385CAT	1171385	O-Ring Seal - 13.94mm x 2.62mm	EA	6	
1178801CAT	117-8801	O-Ring Seal - 126.67 x 2.62mm, Material - Fluorocarbon Rubber	EA	1	
1182797CAT	1182797	Water Manifold Outlet Gasket - Multiple Engines	EA	1	
1185068CAT	118-5068	O-Ring Seal - 15.54 x 2.62mm, Material - Hydrogenated Nitrile	EA	1	
1198784CAT	1198784	Fuel Injector O-Ring	EA	1	
1210145CAT	1210145	O-Ring Seal - 28.17mm x 3.53mm	EA	1	
1223772CAT	122-3772	O-Ring Seal - 215.49 x 3.53mm, Material - Hydrogenated Nitrile	EA	1	
1250434CAT	1250434	Integral Water Lines Group Seal Gasket	EA	1	
1262702CAT	1262702	Air Intake Seal - 0.1 lbs/ 0.04 kgs	EA	1	
1262704CAT	1262704	Gasket Seal - CGU; 0.1 lbs/ 0.04 kgs	EA	1	
1264935CAT	1264935	Gasket Seal - 3400E; 0.2 lbs/ 0.09 kgs	EA	1	
1280317CAT	1280317	Water Pump Group Seal	EA	1	
1282922CAT	128-2922	Water Pump Gasket Set - 0.4 lbs/ 0.18 kgs, 5" Length, 27mm Width, 27mm Depth, 11 Application: 3400	EA	1	Caterpillar Water Pump Installation Gasket Kit PN: 128-2922 - For use on C-9 MFF; 3406E 2WS; 3406C 3ZJ, 4CK, 8PN; 3406B all serials; 3406 92U
1292181CAT	1292181	Integral Seal - Multiple Applications	EA	1	
1293948CAT	1293948	Integral Compressor Group Seal	EA	1	
1299452CAT	1299452	Exhaust Manifold Gasket - 3400	EA	1	
1343761CAT		Piston Ring - Top, 3406E	EA	1	
1359819CAT	1359819	Filler Group Gasket	EA	1	
1367226CAT	136-7226	O-Ring Seal - 3400E; 19.28mm OD; 1.78mm X-Section Dia.; Material - Fluorocarbon Rubber	EA	1	
1367227CAT	136-7227	O-Ring Seal - 19.18 x 2.46mm, Material - Fluorocarbon Rubber; Coating-PTFE	EA	1	
1384611CAT	1384611	Exhaust Manifold Gasket - Round Port, 0.1 lbs/ 0.04 kgs, 3400	EA	1	2 Gaskets Required per Cylinder

Part No.	OEM No.	Description	UOM	SPQ	Comment
1393550CAT	1393550	Regulator Housing Gasket	EA	1	
1415787CAT		Oil Cooler & Lines Gasket Set - 3400E	EA	1	
1422329CAT	1422329	Drainback Seal - 3406E	EA	1	
1425867CAT	1425867	Crankshaft Oil Seal Group Gasket - Front, 3400, 0.7 lbs/ 0.31 kgs; 1 PC Seal and Wear Sleeve Combo	EA	1	
1425868CAT	1425868	Crankshaft Oil Seal Group Gasket - Rear, 3400, 0.7 lbs/ 0.31 kgs, 17mm Length, 5" Width, 17mm Depth; Flanged Face Sleeve	EA	1	Caterpillar Rear Crankshaft Seal PN: 142-5868 - For use on 3406E 1LW; 3406E 1MM; 3406E 2WS 3406E 5DS; 3406E 5EK; 3406E 6TS; 3406C 5KJ; 3406C 8PN; 3406B 5KJ
1426217CAT	1426217	Cylinder Liner O-Ring Seal	EA	6	
1427072CAT	1427072	Cylinder Liner O-Ring Seal - 140.2mm ID; Coolant Seal	EA	6	
1440480CAT	1440480	Governor Group Gasket - 3400	EA	1	
1440481CAT	1440481	Fuel Pump Mounting Gasket - 3400	EA	1	
1440482CAT	1440482	Fuel Pump Group Gasket - 3400E	EA	1	
1464229CAT	1464229	Single Cylinder Head Gasket Set - 3406B 4MG	EA	1	
1482903CAT	148-2903	Fuel Injector Pump Group O-Ring Seal - Teflon coated, 3126; 31.34 x 3.53mm, Material - Rubber	EA	1	
1495240CAT	149-5240	Backup Pump Group O-Ring Seal - 32.36 x 37.36mm, Material - Plastic	EA	1	
1539653CAT	1539653	Cylinder Head Gasket - 3406E; ESN Ranges: 1LW0001-00229; 2SW0001-0405; 5DS0001-00048; 6TS0001-20554; 5EK 0001-up	EA	1	
1555619CAT	1555619	Flywheel Housing Gasket - 3406	EA	1	
1609874CAT	1609874	Single Cylinder Liner Gasket Set - 3406/ 3412 0.1 lbs/ 0.04 kgs	EA	1	Caterpillar Cylinder Liner Seal Kit - Single PN: 160-9874 - For use on 3406E 1LW; 3406E 2WS 3406E 5EK; 3406E 6TS; 3406C 3ZJ; 3406C 4CK; 3406C 5KJ; 3406C 8PN; 3406B 2EK; 3406B 3ZJ; 3406B 4CK; 3406B 4MG; 3406B 5KJ; 3406B 5YG; 3406B 7FB; 3406B 8TC
1632478CAT	1632478	Valve Stem Seal	EA	6	
1661781CAT	1661781	Housing Cover Gasket - Front	EA	1	

Caterpillar 3406 Engine Parts

Part No.	OEM No.	Description	UOM	SPQ	Comment
1662903CAT	1662903	O-Ring Seal - 34.59mm x 2.62mm, Upper Seal	EA	6	
1662904CAT	1662904	O-Ring Seal - TFEP, 34.59mm x 2.62mm, Middle Seal	EA	6	
1663718CAT	1663718	Fuel Injector O-Ring Seal - Tube 3400, 0.1 lbs/ 0.04 kgs	EA	6	
1669144CAT	1669144	Housing Gasket - Front, 3406E	EA	1	
1685248CAT	1685248	Isolation Seal Gasket	EA	1	
1697487CAT	169-7487	O-Ring Seal - 18.64 x 3.53mm, Material - Hydrogenated Nitrile	EA	1	
1765749CAT	1765749	Piston Ring - Intermediate, 3406E	EA	1	
1853241CAT	1853241	O-Ring Seal - 92.41 x 2.62mm, Material - Fluorocarbon Rubber	EA	1	
1891814CAT	1891814	Oil Cooler & Lines Gasket Set - 3400	EA	1	
1899771CAT	189-9771	Oil Control Piston Ring - Intermediate, 3406E/ C15	EA	1	
19590JCB	143-6505	Extarder Gasket - Model EX83	EA	1	
19594JCB	19594	Turbocharger Gasket	EA	1	
1978418CAT	1978418	Turbocharger Lines Gasket - 0.1 lbs/ 0.04 kgs	EA	1	
1978419CAT	1978419	Oil Turbocharger Gasket - End Item Identification: MRAP M-ATV; 0.1 lbs/ 0.04 kgs	EA	1	
1H1023CAT	1H1023	O-Ring Seal - Nitrile, 9.25mm x 1.78mm	EA	12	
1J9671CAT	1J-9671	O-Ring Seal - 10.52 x 1.83mm, Material - Nitrile Rubber	EA	12	
1P436CAT	1P436	Fuel Priming Pump Gasket	EA	24	
1S4295CAT	1S4295	Turbocharger Mounting Gasket; 3406B (PEEC)	EA	1	
1S4810CAT	1S4810	Turbocharger Oil Line Drain Gasket - 0.1 lbs/ 0.04 kgs; 1-1/4" Dia.Center Hole	EA	1	
1S6595CAT	1S6595	Turbocharger Oil Line Supply Gasket - 0.1 lbs/ 0.04 kgs; 3/4" Dia.Center Hole	EA	1	
1S7057CAT	1S7057	General Usage Gasket - Multiple Engines	EA	1	
1W2636CAT	1W2636	Water Pump Mounting Gasket - Late Style, 0.062" Thick	EA	1	
1W8922CAT		Ring Set - 3400	EA	1	

Part No.	OEM No.	Description	UOM	SPQ	Comment
20229JCB	20229	Upper Ring Seal	EA	1	
2147566CAT	2147566	O-Ring Seal - Sensor	EA	1	
2147568CAT	2147568	O-Ring Seal - 11.89mm x 1.98mm	EA	6	
2153198CAT	2153198	Fuel Injector Pump Group O-Ring Seal - External, Top Seal, C15/ 3406E	EA	6	
2161252CAT	2161252	Single Cylinder Head Gasket Set - 3406/ 3406E	EA	1	
2173673CAT		Isolation Seal	EA	1	
2245122CAT	2245122	Cylinder Head Gasket - 3406E	EA	1	
2245797CAT	2245797	External Injector Seal Kit (See comments)	EA	1	For 1 injector:
2271204CAT	2271204	Cylinder Head Shim - 3406E	EA	1	
2303728CAT	2303728	Fuel Group O-Ring Seal	EA	1	
2303775CAT	2303775	Fuel Injector Group O-Ring Seal - C15, 3406E	EA	6	
2323679CAT	2323679	Gasket Set - Rear Structure - 3400E	EA	1	
2326652CAT	2326652	Single Cylinder Head Gasket Set - 3406B 7FB	EA	1	
2336984CAT	2336984	Gasket Set - Front Structure, 3406E	EA	1	
2341866CAT	2341866	Gasket Set - Front Structure	EA	1	
2341874CAT	2341874	Gasket Set - Front Structure, 3406	EA	1	
2373800CAT	2373800	Fuel Injector Pump Group O-Ring Seal - 0.1 lbs/ 0.04 kgs, 3126B & 3126E	EA	1	
2411JCB	2411	O-Ring - 0.365" ID x 0.07" W	EA	1	
2421539CAT	2421539	Single Fuel O-Ring Kit	EA	1	
2429537CAT	2429537	Rocker Cover Seal	EA	1	
2457339CAT	2457339	Crankshaft Seal - Front	EA	1	
2481394CAT	2481394	External Injector Seal Kit - HEUI	EA	1	For 1 Injector: Kit Contains: (Top Seal), (Middle Seal), & (Lower Seal)
2486744CAT	2486744	Single Cylinder Head Gasket Set - 5.6 lbs/ 2.54 kgs, For Use On C-9 MFF; 3406E 1LW; 3406E 1mm, 3406E 2WS; 3406E 5DS; 3406E 6TS	EA	1	
2746851CAT	2746851	Turbocharger Mounting Gasket	EA	1	
2902060CAT		Single Cylinder Head Gasket Set - 3400	EA	1	
2974841CAT	2974841	Gasket - Set Single Fuel System	EA	1	

Caterpillar 3406 Engine Parts

Part No.	OEM No.	Description	UOM	SPQ	Comment
2A3398CAT	2A3398	Oil Pan Drain Plug Gasket - Multiple Applications	EA	1	
2H2665CAT	2H2665	O-Ring Seal - 62.87 x 5.33mm, Material - Nitrile Rubber	EA	1	
2M4453CAT	2M-4453	General Usage O-Ring Seal - 12.29 x 3.53mm, Material - Nitrile Rubber	EA	6	
2M9780CAT	2M9780	General Usage O-Ring Seal - 0.1 lbs/0.04 kgs, USA Genitrile (90), 19.18mm x 2.46mm	EA	6	
2N3350CAT	2N3350	O-Ring Seal - 21.59 x 5.33mm, Material - Fluorocarbon Rubber	EA	1	
2N8204CAT	2N8204	Intake Manifold Gasket - 3400	EA	1	
2P2817CAT		Piston Ring - Intermediate, 3400	EA	1	
2W459CAT	2W459	Cover Gasket - Auto Timing Advance	EA	1	
3406062MCB-CAT		Inframe Gasket Kit - Cat 3406B	EA	1	
3406462MCB-CAT		Inframe Chassis Gasket Set - 3406E 5EK	EA	1	
3D2824CAT	3D-2824	General Usage O-Ring Seal - 23.47 x 2.95mm, Material - Nitrile Rubber	EA	3	
3H1461CAT	3H-1461	O-Ring Seal - 34.52 x 3.53mm, Material - Nitrile Rubber	EA	6	
3J1907CAT	3J1907	Fuel Injector O-Ring Seal - Liter Line	EA	12	
3J7354CAT	3J7354	O-Ring Seal - 8.9mm x 1.8mm	EA	6	
3P1155CAT	3P-1155	O-Ring Seal - 24.99 x 3.53mm, Material - Fluorocarbon Rubber; CGU	EA	1	
3P1156CAT	3P-1156	O-Ring Seal - 21.82 x 3.53mm, Material - Fluorocarbon Rubber	EA	6	
3P650CAT	3P-0650	O-Ring Seal - 50.16 x 5.33mm, Material - Fluorocarbon Rubber	EA	1	
3S9643CAT	3S9643	Thermostat Seal	EA	1	
4D3107CAT	4D3107	O-Ring Seal - 37.77 x 2.62mm, Material - Nitrile Rubber; CGU	EA	6	
4F7387CAT	4F7387	Oil Cooler O-Ring Seal - 100.97 x 5.33mm, Material - Nitrile Rubber	EA	1	
4F7391CAT	4F7391	O-Ring Seal - 32.92mm x 3.53mm	EA	6	
4F9029CAT	4F9029	O-Ring Seal - 29.74mm x 3.53mm	EA	6	
4F9653CAT	4F-9653	Pre-Combustion Chamber O-Ring Seal - 46.99 x 5.33mm, Material - Nitrile Rubber	EA	6	

Part No.	OEM No.	Description	UOM	SPQ	Comment
4J5351CAT	4J5351	O-Ring Seal - 17.12mm x 2.62mm	EA	6	
4J8997CAT	4J-8997	General Usage O-Ring Seal - 28.17 x 3.53mm, Material - Nitrile Rubber	EA	6	
4K1388CAT	4K-1388	O-Ring Seal - 26.95 x 2.95mm, Material - Nitrile Rubber	EA	6	
4N1151-6CAT	4N1151-6	Oil Pan Gasket- 1 PC	EA	1	2 gaskets are required with pan spacer plate
4N1151CAT	4N1151	Oil Pan Gasket - 3400, Puzzle style	EA	1	2 gaskets required with pan spacer plate
4N1156CAT	4N1156	Thermostat Housing Cover Gasket	EA	1	
4N7253CAT	4N7253	Pre-Combustion Chamber Gasket	EA	1	
4P3977CAT	4P3977	Air Compressor Cylinder Head Gasket	EA	1	
4W4014CAT	4W4014	Water Outlet Housing Gasket - 6 Bolt	EA	1	
4Y9652CAT	4Y9652	Cylinder Block Cover Gasket	EA	1	
5E8771CAT	5E-8771	O-Ring Seal - 120.32 x 2.62mm, Material - Fluorocarbon Rubber	EA	1	
5H7704CAT	5H7704	O-Ring Seal - 94.61mm x 6.99mm	EA	6	
5P4889CAT	5P-4889	O-Ring Seal - 75.79 x 3.53mm, Material - Fluorocarbon Ruber	EA	1	
5P5678-30CAT	5P5678-30	Valve Cover Seal - 1 Bag = 30 Meters	EA	30	9 Meters required when equipped with Jake Brake
5P5846CAT	5P5846	Oil Pump Suction Tube O-Ring Seal Gasket - 0.1 lbs/ 0.04 kgs, Tubeviton (75) 40.64mm x 5.33mm	EA	1	
5P7701CAT	5P-7701	O-Ring Seal - 29.74 x 2.95mm, Material - Fluorocarbon Rubber	EA	1	
5P7814CAT	5P7814	O-Ring Seal - 10.52mm x 1.83mm	EA	1	
5P8068CAT	5P8068	Oil Pump Suction Tube O-Ring Seal Gasket - 0.1 lbs/ 0.04 kgs, Tubeviton (75) 37.47mm x 5.33"	EA	6	
5P8211CAT	5P-8211	O-Ring Seal - 50.39 x 3.53mm, Material - Fluorocarbon Rubber	EA	1	
5P8356CAT	5P8356	O-Ring Seal - 21.89 x 2.62mm, Material - Fluorocarbon Rubber	EA	1	
5P8768CAT	5P8768	Single Cylinder Liner Gasket Set	EA	1	
6J2245CAT	6J-2245	O-Ring Seal - 17.12 x 2.62mm, Material - Fluorocarbon Rubber	EA	6	
6V1197CAT	6V1197	O-Ring Seal - 98.02 x 3.53mm, Material - Fluorocarbon Rubber	EA	1	

Caterpillar 3406 Engine Parts

Part No.	OEM No.	Description	UOM	SPQ	Comment
6V1903CAT	6V1903	O-Ring Seal - 26.59mm x 2.95mm	EA	1	
6V3319CAT	6V-3319	O-Ring Seal - 158.34 x 3.53mm, Material - Fluorocarbon Rubber	EA	1	
6V3348CAT	6V-3348	O-Ring Seal - 18.42 x 5.33mm, Material - Fluorocarbon Rubber	EA	1	
6V3834CAT	6V-3834	O-Ring Seal - 88.67 x 2.62mm, Material - Fluorocarbon Rubber	EA	1	
6V4589CAT	6V-4589	O-Ring Seal - 19.18 x 2.46mm, Material - Fluorocarbon Rubber	EA	1	
6V5048CAT	6V5048	O-Ring Seal - 8.92mm x 1.83mm	EA	1	
6V5050CAT	6V-5050	O-Ring Seal - 23.47 x 2.95mm, Material - Fluorocarbon Rubber	EA	1	
6V5063CAT	6V-5063	O-Ring Seal - 23.47 x 2.95mm, Material - EPDM (70 Duro)	EA	6	
6V5134CAT	6V5134	O-Ring Seal - 31.12mm x 5.33mm, Material - Fluorocarbon Rubber	EA	1	
6V5266CAT	6V5266	O-Ring Seal - 36.09mm x 3.53mm	EA	1	
6V5759CAT	6V5759	O-Ring Seal - 10.69 x 3.53mm, Material - Fluorocarbon Rubber	EA	6	
6V6228CAT	6V-6228	O-Ring Seal - 26.64 x 2.62mm, Material - Fluorocarbon Rubber	EA	1	
6V6353CAT	6V-6353	O-Ring Seal - 101.19 x 3.53mm, Material - Fluorocarbon Rubber	EA	1	
6V6609CAT	6V6609	O-Ring Seal - 16.36mm x 2.21mm, Material - EPDM (70 Duro); Dash size 908	EA	6	
6V7350CAT	6V7350	O-Ring Seal - 3126; 113.97 x 2.62mm, Material - Fluorocarbon Rubber	EA	1	
6V8397CAT	6V-8397	O-Ring Seal - 12.83mm OD, 1.78mm X-Section Dia.; Material - Nitrile Rubber	EA	5	
6V8398CAT	6V-8398	O-Ring Seal - 16.03mm OD; 1.78mm X-Section Dia.; Material - Nitrile Rubber	EA	6	
6V9027CAT	6V-9027	O-Ring Seal - 8.92 x 1.83mm, Material - EPDM (70 Duro)	EA	6	
6V9746CAT	6V9746	O-Ring Seal - 18.94mm x 1.78mm	EA	6	
7C1728CAT	7C1728	Rear Crankshaft Seal Gasket - 1.7	EA	1	
7J204CAT	7J-0204	O-Ring Seal - 7.65 x 1.63mm, Material - Nitrile Rubber	EA	6	
7L6580CAT	7L6580	O-Ring Seal - 31.12mm x 5.33mm, Material - EPDM (70 Duro)	EA	6	
7N7078CAT	7N7078	Piston Oil Control Ring - 3400	EA	1	

Part No.	OEM No.	Description	UOM	SPQ	Comment
7S3206CAT	7S3206	Pre-Combustion Chamber O-Ring Seal	EA	2	
7W2398CAT	7W2398	Liner Gasket Group	EA	1	
7W6081CAT	7W6081	Cover Gasket - 3400	EA	1	
8C5230CAT	8C5230	O-Ring Seal - 43.82mm x 5.33mm	EA	1	
8H2778CAT	8H2778	Fuel Filter Gasket - 0.1 lbs/ 0.04 kgs	EA	1	
8H9788CAT	8H9788	Turbocharger Supply Gasket	EA	1	
8J4351CAT	8J-4351	O-Ring Seal - 44.04 x 3.53mm, Material - Fluorocarbon Rubber	EA	1	
8L2777CAT	8L2777	O-Ring Seal - 10.77mm x 2.62mm	EA	12	Used in rocker arm assembly
8L2779CAT	8L-2779	O-Ring Seal - 9.25 x 1.78mm, Material - Fluorocarbon Rubber	EA	6	
8L2786CAT	8L2786	O-Ring Seal - 16.36mm x 2.21mm, Material - EPDM (70 Duro)	EA	6	
8M4445CAT	8M4445	O-Ring Seal - 21.82mm x 3.53mm	EA	6	
8M7065CAT		Air Compressor Gasket	EA	1	
8M8515CAT	8M-8515	O-Ring Seal - 32.99 x 2.62mm; Material - Silicone Rubber	EA	6	
8N5763CAT	8N5763	Fuel Group Seal	EA	1	
8T9527CAT	8T-9527	O-Ring Seal - 110.72 x 3.53mm, Material - Fluorocarbon Rubber	EA	1	
9L5854CAT	9L5854	Cylinder Liner Band - Upper, 3400	EA	6	
9L5854CAT	9L5854	Cylinder Liner Band - 3400; Upper Band Seal	EA	6	1 Per Liner
9L9098CAT	9L9098	Fuel Injector Seal - Carbon Stop	EA	10	
9M3786CAT	9M-3786	Water Pump O-Ring Seal	EA	1	
9M4849CAT	9M-4849	Engine Oil Lines Group O-Ring Seal - 23.16 x 5.33mm, Material-Silicone Rubber	EA	6	
9M7002CAT	9M7002	O-Ring Seal - 37.77 x 5.33mm, Material - Silicone Rubber	EA	1	
9X7317CAT	9X7317	Fuel Injector O-Ring Seal - External, Lower Seal; C15, 3406E	EA	6	Center O-Ring on Injector
9X7418CAT	9X7418	Fuel Injector O-Ring Seal - External, Middle	EA	1	
9X7430CAT	9X7430	Fuel Injector Sleeve O-Ring Seal - lower seal	EA	6	
9X7722CAT	9X7722	O-Ring Seal - 31.42mm x 2.62mm	EA	1	
9X7735CAT	9X7735	Fuel Injector O-Ring Seal - External, 3406C	EA	6	

Caterpillar 3406 Engine Parts

Part No.	OEM No.	Description	UOM	SPQ	Comment
9Y1979CAT	9Y1979	Exhaust Manifold Gasket - 3300, 3304	EA	1	
9Y2588CAT	9Y2588	Thermostat Housing Gasket - 5 Bolt; 3400; 0.1 lbs/ 0.04 kgs	EA	1	
CB-3406113CAT		Cylinder Head Gasket - 3406C, 19 Bolt	EA	1	
CB-3406273CAT		Cylinder Head Gasket - 3406C, 24 Bolt	EA	1	
CB399014CAT	CB399014	Single Cylinder Head Gasket Set	EA	1	
M4N1151-6CAT		Oil Pan Gasket - 1 PC, 3400 Series	EA	1	
MCB-3406463CAT		Cylinder Head Gasket Kit - 3406E 5EK	EA	1	
MCB-3406473CAT		Cylinder Head Gasket Kit - 3406E LLW 2WS 5DS 6T	EA	1	
MCBC-15093CAT	MCBC15093	Cylinder Head Gasket Kit	EA	1	
MRS3406E-2CAT		Ring Set - 3406E	EA	1	

Table 91: Hardware

Part No.	OEM No.	Description	UOM	SPQ	Comment
ADAPTERS					
1006920CAT	1006920	Cylinder Head Nozzle Adapter - 3400DI, Uses 8M5429 O-Ring & 4N7253 Gasket	EA	1	
BOLTS					
0L1352CAT	0L1352	Bolt - 3/8" x 3.25"	EA	10	Used with Air Compressor and Water lines
0L2070CAT	0L2070	Bolt- 3/8"-16 x 2.25" Caterpillar	EA	10	
0S1571CAT	0S1571	Bolt - 3/8" x 1.25"	EA	10	
0S1573CAT	0S1573	Bolt - 1/2" x 4"	EA	1	
0S1588CAT	0S1588	Bolt - 3/8"-16 x 1.25"	EA	6	
0S1590CAT	0S1590	Bolt - 3/8" x 2"	EA	10	
0S1591CAT	0S1591	Capscrew - 3/8" NC x 1-1/2" or 38mm	EA	6	
0S1594CAT	0S1594	Cylinder Head Cover Capscrew	EA	10	

Part No.	OEM No.	Description	UOM	SPQ	Comment
0S1617CAT	0S1617	Hex Bolt - 5/16"-18 x 34"	EA	10	
0S1618CAT	0S1618	Bolt - 5/16" x 1"	EA	10	
1A9579CAT	1A9579	Bolt - 5/16" x 1.5"	EA	6	
1D4595CAT	1D4595	Cylinder Head Bolt - 152.0mm Long x 12.22mm Head Height	EA	1	
2A1538CAT	2A1538	Bolt - 3/4" x 2"	EA	1	
2H3750CAT	2H3750	Cylinder Head Bolt - 3400	EA	1	
2N2765CAT	2N2765	Turbocharger Bolt - High Temp	EA	4	
3B1915CAT	3B1915	Bolt - 3/8" x 1-3/8"	EA	1	
5B0841TRP	5B0841	Bolt For Caterpillar Flywheel	EA	6	
6N8942CAT	6N8942	Connecting Rod Bolt - 3400	EA	1	
7E4195CAT	7E4195	Connecting Rod Bolt - C15, 3406	EA	1	
7M4843CAT	7M4843	Lock Bolt	EA	1	
8S9191CAT	8S9191	Injector Hold Down Bolt - 3/8" x 4"- C15, 3406E	EA	2	
9L7816CAT	9L7816	Flywheel Bolt	EA	1	

GROMMETS

3E6772CAT	3E6772	Cylinder Head Water Grommet	EA	12	
-----------	--------	-----------------------------	----	----	--

ISOLATORS

7C8296CAT	7C8296	Isolator	EA	6	
-----------	--------	----------	----	---	--

LOCKS

2A4429CAT	2A4429	Valve Lock	EA	12	
-----------	--------	------------	----	----	--

NOZZLES

9L6884CAT	9L6884	Fuel Nozzle Assembly - 3400	EA	1	
4W7018CAT	4W7018	Fuel Nozzle - 3406B	EA	1	

NUTS

2N2766CAT	2N2766	Exhaust Manifold Lock Nut	EA	12	
9X6620CAT	9X6620	Lock Nut	EA	1	

PIN/ ROLLER KITS

2038822PRCAT	2038822PR	Pin & Roller Valve Kit - 3406E	EA	1	
--------------	-----------	--------------------------------	----	---	--

Part No.	OEM No.	Description	UOM	SPQ	Comment
PINS					
1687246CAT	1687246	Piston Pin	EA	1	
1S5440CAT	1S5440	Dowel Pin	EA	1	
7E1177CAT	7E1177	Piston Retainer Pin - 3406E	EA	2	Use With 2.165 Pin Diameter
7E1177CAT	7E1177	Piston Retainer Pin - 3406E	EA	2	
7E5665CAT	7E5665	Piston Retainer Pin - 3400	EA	2	Use With 2.000 Pin Diameter
8N1608CAT	8N1608	Piston Pin - 3400	EA	1	
PLUGS					
1656170CAT	1656170	Plug - 3400	EA	1	
SLEEVES					
2274239CAT	2274239	Injector Sleeve - 3406E	EA	1	
SPACERS					
1064159CAT	1064159	Exhaust Manifold Spacer - 11.13mm ID x 19.05mm OD x 13.5-mm Thick	EA	1	
1083612CAT	1083612	Exhaust Manifold Spacer - 11.13mm ID x 19.05mm OD x 53-mm Thick	EA	1	
2S3770CAT	2S3770	Exhaust Manifold Spacer - 11mm x 19mm x 33.5mm Thick	EA	1	
7W7488CAT	7W7488	Valve Spring Spacer - 3300	EA	2	
SPRINGS					
3056843CAT	3056843	Guide Lifter Spring - 3400	EA	1	
7S7144CAT	7S7144	Intake/ Exhaust Valve Spring	EA	2	
STUDS					
1061792CAT	1061792	Exhaust Manifold Stud - 3406E	EA	6	
1061793CAT	1061793	Exhaust Manifold Stud - Taperlock; 3406E	EA	1	
4S6137CAT	4S6137	Cylinder Head Exhaust Manifold Taperlock Stud - 0.1 lbs/ 0.04 kgs, 3/8" x 3.1"	EA	5	
6L8562CAT	6L8562	Cylinder Head Exhaust Manifold Stud - 0.1 lbs/ 0.04 kgs, 3/8" x 1-3/4"	EA	1	
MCB3406ESKCAT		Exhaust Manifold Stud Kit - 3406E	EA	1	Contains Nuts and Studs
MCB3406SKCAT		Exhaust Manifold Stud Kit - 3406B	EA	1	

Part No.	OEM No.	Description	UOM	SPQ	Comment
WASHERS					
1143364CAT	1143364	Stat-O-Seal Washer	EA	6	
2N7174CAT	2N7174	Spark Plug Adapter Washer	EA	6	
3H7654CAT	3H7654	Cylinder Head Washer - Steel, 13.5mm x 22.0mm x 3.2mm Thick	EA	6	
5H1504CAT	5H1504	Head Bolt Hard Washer	EA	6	
5M2894CAT	5M2894	Exhaust Manifold Washer - Steel, 22/32" OD x 13/32" ID X 0.109" Thick	EA	4	
5P1075CAT	5P1075	Hardened Washer - Chromate, Yel- low, Raised Shape, Must be within 18mm Dia.	EA	10	
5R7137CAT	5R7137	Bonded Seal Washer	EA	1	
7W4487CAT	7W4487	Washer - 9.7mm Nominal Hole Dia., Peripheral Shape Style: 1 Round, Center Hole Shape Style: 1 Round	EA	6	
8H9204CAT	8H9204	Fuel Pump Felt Washer	EA	6	
8M7145CAT	8M7145	Exhaust Manifold Washer- 1/14" OD x 13.32" ID x 3/16" Thick	EA	6	
9M6527CAT	9M6527	Hardened Washer - Steel, 0.375" Nominal Hole Diameter, Peripheral Shape Style: 1 Round	EA	6	

NATURAL GAS ENGINE COMPONENTS

Quality Engine parts for the Natural Gas Engine.

SPARK PLUGS

Table 92: Spark Plugs

Part No.	OEM No.	Description	UOM	Qty. Per Engine	SPQ
GK3-1A		Iridium Saver Spark Plug	EA		4

HARDWARE

Table 93: Hardware

Part No.	OEM No.	Description	UOM	Qty. Per Engine	SPQ
WASHERS					
2N7174CAT	2N7174	Spark Plug Adapter Washer	EA	6	6

CROSS REFERENCE

Table 94: OEM/ MFR Cross Reference

OEM/ MFR No.	Part No.	Page No.
061-8561	0618561CAT	47
0L1352	0L1352CAT	56
0L2070	0L2070CAT	56
0R3421	0R3421CATR	43
0R3423	0R3423CATR	43
0R3587	0R3587CATR	43
0R3588	0R3588CATR	43
0R-3674	0R3674CATR	25
0R4120	RW6012RXM1DRMAN	15
0R4120	RW6012XM1DRMAN	15
0R4337	0R4337CATR	43
0R7653	0R7653CATR	33
0R-8217	RW1194PXM1DRMAN	15
0R8218	RW6012RXM1DRMAN	15
0R8218	RW6012XM1DRMAN	15
0R8289	0R8289CATR	43
0R8330	RW6012RXM1DRMAN	15
0R8330	RW6012XM1DRMAN	15
0R8340	5002984BXR	12
0R8442	5002983BXR	12
0R8783	0R8783CATR	43
0R-9375	0R9375CATR	25
0S1571	0S1571CAT	56
0S1573	0S1573CAT	56
0S1588	0S1588CAT	56
0S1590	0S1590CAT	56
0S1591	0S1591CAT	56
0S1594	0S1594CAT	30
0S1617	0S1617CAT	57
0S1618	0S1618CAT	57
1003652	1003652CAT	18
1006178	1006178CAT	12
1006920	1006920CAT	27
1013125	1013125CAT	47
1017788	1017788CAT	28

OEM/ MFR No.	Part No.	Page No.
1024612	1024613JCB	38
1024612	1024614JCB	38
1024613	1024613JCB	38
1025939	1025939CAT	15
1031800	1031800CAT	27
1033020	1033020JCB	37
1036045	1036045CAT	34
1043560	1043560CAT	23
1048585	1048585CAT	43
1052508	1052508CAT	45
1061792	1061792CAT	31
1061793	1061793CAT	31
1064159	1064159CAT	30
1075769	1075769CAT	47
107-6280	1076280CAT	47
1082	1082JCB	38
1082102	1082102CAT	44
1083	1083JCB	38
1083612	1083612CAT	30
1090072	1090072CAT	35
1090077	1090077CAT	34
1090078	1090078CAT	47
1095313	1095313CAT	47
10R0483	RW6012RXM1DRMAN	15
10R0483	RW6012XM1DRMAN	15
10R0484	RW6014XM1DRMAN	15
10R3292	10R3292CATR	33
10R-4359	10R4359BRCATR	25
10R4359BR	10R4359BRCATR	25
10R-5984	10R5984BRCATR	25
10R-5985	10R5985BRCATR	25
10R7155	10R7155CATR	33
10R8501	10R8501CATR	43
10R8502	10R8502CATR	43
1100004	1100004CAT	12
1102220	1102220CAT	23
1105800	1105800CAT	23
1118010	1118010CAT	13

Caterpillar 3406 Engine Parts

OEM/ MFR No.	Part No.	Page No.	OEM/ MFR No.	Part No.	Page No.
112-5282	1125282CAT	48	14087	14087JCB	36
1142687	1142687CAT	48	141-8938	1418938CAT	10
1143364	1143364CAT	59	1422329	1422329CAT	32
1144427	1144427CAT	48	1425867	1425867CAT	18
1152367	1152367CAT	26	1425868	1425868CAT	18
1152368	1152368CAT	26	1426217	1426217CAT	21
1171385	1171385CAT	48	1427072	1427072CAT	23
117-8801	1178801CAT	48	143-6455	12246JCB	37
1182797	1182797CAT	48	1436456	12261JCB	37
118-5068	1185068CAT	48	143-6456	12261JCB	37
1193075	1193075CAT	13	1436479	14087JCB	36
1198784	1198784CAT	43	143-6479	14087JCB	36
1210145	1210145CAT	48	1436505	19590JCB	38
122-3772	1223772CAT	48	143-6505	19590JCB	38
12246	12246JCB	37	1436590	18233JCB	37
12261	12261JCB	37	143-6590	18233JCB	37
1250434	1250434CAT	16	1436622	19461JCB	36
1262702	1262702CAT	48	143-6622	19461JCB	36
1262704	1262704CAT	48	1436628	19654JCB	36
1264935	1264935CAT	48	143-6628	19654JCB	36
1280317	1280317CAT	16	1436642	20229JCB	38
128-2922	1282922CAT	16	143-6642	20229JCB	38
1292181	1292181CAT	48	1440480	1440480CAT	45
1293948	1293948CAT	12	1440481	1440481CAT	46
1299452	1299452CAT	28	1440482	1440482CAT	46
1310510	1310510CATR	33	1464229	1464229CAT	29
1326663	1326663CAT	24	148-2558	1024613JCB	38
1330125	1330125CAT	34	148-2903	1482903CAT	49
1354925	1354925CAT	15	149-5240	1495240CAT	49
135-4928	1354928CAT	16	1539653	1539653CAT	28
1359819	1359819CAT	48	1555619	1555619CAT	40
1365716	1365716CATR	33	1564162	25223JCB	37
136-7226	1367226CAT	48	156-4162	25223JCB	37
136-7227	1367227CAT	48	1609874	1609874CAT	21
1368882	1368882CATR	17	1615719	1615719CAT	15
1375541	1375541CAT	45	1631533	1024610JCB	38
1384611	1384611CAT	28	163-1533	1024610JCB	38
1393550	1393550CAT	14	1631547	1024614JCB	38

OEM/ MFR No.	Part No.	Page No.	OEM/ MFR No.	Part No.	Page No.
163-1547	1024614JCB	38	1H1023	1H1023CAT	50
1631550	1024613JCB	38	1J-9671	1J9671CAT	50
163-1550	1024613JCB	38	1P436	1P436CAT	46
1632478	1632478CAT	27	1Q9830	18188JCB	37
1656170	1656170CAT	32	1Q-9830	18188JCB	37
1661781	1661781CAT	33	1S4295	1S4295CAT	11
1662903	1662903CAT	50	1S4810	1S4810CAT	11
1662904	1662904CAT	50	1S5440	1S5440CAT	30
1663718	1663718CAT	44	1S6595	1S6595CAT	11
1669144	1669144CAT	33	1S7057	1S7057CAT	50
1678126	1678126CAT	17	1W2636	1W2636CAT	16
1685248	1685248CAT	32	1W5283	1W5283CAT	27
1687246	1687246CAT	24	1W9168	1W9168CAT	45
169-7487	1697487CAT	50	1W9169	1W9169CAT	45
1765749	1765749CAT	24	20229	20229JCB	38
1779601	28343JCB	38	2038822PR	2038822PRCAT	27
177-9601	28343JCB	38	2075248PR	2075248PRCAT	43
1807352	1807352CAT	24	2147566	2147566CAT	51
18188	18188JCB	37	2147568	2147568CAT	51
18233	18233JCB	37	2153198	2153198CAT	44
1853241	1853241CAT	50	2165582	2165582CAT	33
189-9771	1899771CAT	24	2165583	2165583CAT	33
1917941	1917941CAT	42	2170752	2170752CAT	33
1917942	1917942CAT	42	2243246	2243246CAT	21
1917943	1917943CAT	42	2245122	2245122CAT	29
1917944	1917944CAT	42	2245797	2245797CAT	44
1917945	1917945CAT	42	2271204	2271204CAT	29
1917946	1917946CAT	42	2274239	2274239CAT	44
19229	19229JCB	37	2299	2299JCB	39
19461	19461JCB	36	2303728	2303728CAT	46
19594	19594JCB	11	2303775	2303775CAT	43
19654	19654JCB	36	2323679	2323679CAT	51
1978418	1978418CAT	10	2326652	2326652CAT	29
1978419	1978419CAT	11	2336984	2336984CAT	51
1979322	1979322CAT	22	2341866	2341866CAT	51
1979322	1979322TRP	22	2341874	2341874CAT	51
1A9579	1A9579CAT	57	2373800	2373800CAT	44
1D4595	1D4595CAT	30	2411	2411JCB	38

OEM/ MFR No.	Part No.	Page No.	OEM/ MFR No.	Part No.	Page No.
2420840	1033020JCB	37	3D-2824	3D2824CAT	52
242-0840	1033020JCB	37	3E6772	3E6772CAT	30
2421539	2421539CAT	46	3H-1461	3H1461CAT	52
2429537	2429537CAT	29	3H7654	3H7654CAT	31
2457339	2457339CAT	18	3J1907	3J1907CAT	44
2477133	2477133CAT	14	3J7354	3J7354CAT	52
2481394	2481394CAT	44	3P-0650	3P650CAT	52
2485513	2485513CAT	13	3P-1155	3P1155CAT	52
2486744	2486744CAT	29	3P-1156	3P1156CAT	52
25223	25223JCB	37	3S9643	3S9643CAT	14
2531752	2531752CAT	17	471120-0001	0R7205TRP	10
2644297	2644297CAT	14	4D3107	4D3107CAT	52
2746851	2746851CAT	10	4F7387	4F7387CAT	34
28343	28343JCB	38	4F7391	4F7391CAT	52
2974841	2974841CAT	46	4F9029	4F9029CAT	52
2A1538	2A1538CAT	57	4F-9653	4F9653CAT	46
2A3398	2A3398CAT	35	4J5351	4J5351CAT	53
2A4429	2A4429CAT	27	4J-8997	4J8997CAT	53
2H2665	2H2665CAT	52	4K-1388	4K1388CAT	53
2H3750	2H3750CAT	30	4N1151	4N1151CAT	33
2M-4453	2M4453CAT	52	4N1151-6	4N1151-6CAT	32
2M9780	2M9780CAT	52	4N1156	4N1156CAT	14
2N2765	2N2765CAT	11	4N5893	4N5893CAT	26
2N2766	2N2766CAT	30	4N7253	4N7253CAT	46
2N3350	2N3350CAT	52	4P2383	4P2383CAT	15
2N7174	2N7174CAT	59	4P3977	4P3977CAT	53
2N8204	2N8204CAT	28	4S6137	4S6137CAT	31
2S3770	2S3770CAT	28	4W2430	4W2430CATR	33
2U1492	1082JCB	38	4W4014	4W4014CAT	16
2U-1492	1082JCB	38	4W5698	4W5698CAT	17
2U1493	1083JCB	38	4W5702	4W5702CAT	20
2U-1493	1083JCB	38	4W7018	4W7018CAT	44
2W3815	2W3815CAT	22	4Y9652	4Y9652CAT	32
2W459	2W459CAT	52	5002983	5002983BXR	12
3056843	3056843CAT	31	5002984	5002984BXR	12
3178766	3178766CAT	28	5E-8771	5E8771CAT	53
3215746	3215746CAT	17	5H1504	5H1504CAT	31
3B1915	3B1915CAT	57	5H7704	5H7704CAT	53

OEM/ MFR No.	Part No.	Page No.
5M2894	5M2894CAT	31
5P1075	5P1075CAT	59
5P-4889	5P4889CAT	53
5P5678-30	5P5678-30CAT	29
5P5846	5P5846CAT	35
5P-7701	5P7701CAT	53
5P7814	5P7814CAT	53
5P8068	5P8068CAT	35
5P-8211	5P8211CAT	53
5P8356	5P8356CAT	53
5P8768	5P8768CAT	21
5R7137	5R7137CAT	59
611453	611453CAT	17
612981	612981CAT	32
614421	614421CAT	32
6J-2245	6J2245CAT	53
6L8562	6L8562CAT	31
6N2985	6N2985CAT	35
6N8942	6N8942CAT	22
6V1197	6V1197CAT	53
6V1903	6V1903CAT	54
6V-3319	6V3319CAT	54
6V-3348	6V3348CAT	54
6V-3834	6V3834CAT	54
6V-4589	6V4589CAT	54
6V5048	6V5048CAT	54
6V-5050	6V5050CAT	54
6V-5063	6V5063CAT	54
6V5134	6V5134CAT	54
6V5266	6V5266CAT	54
6V5759	6V5759CAT	54
6V-6228	6V6228CAT	54
6V-6353	6V6353CAT	54
6V6609	6V6609CAT	54
6V7350	6V7350CAT	54
6V-8397	6V8397CAT	54
6V-8398	6V8398CAT	54
6V-9027	6V9027CAT	54

OEM/ MFR No.	Part No.	Page No.
6V9746	6V9746CAT	54
714508-0003	OR7579TRP	10
7671	7671JCB	37
7C0031	2411JCB	38
7C-0031	2411JCB	38
7C1728	7C1728CAT	18
7C8296	7C8296CAT	30
7C9222	7C9222CAT	15
7E1177	7E1177CAT	24
7E292	7E292CAT	23
7E4195	7E4195CAT	22
7E5665	7E5665CAT	24
7J-0204	7J204CAT	54
7L6580	7L6580CAT	54
7M4843	7M4843CAT	57
7M7219	7M7219CAT	45
7S3206	7S3206CAT	46
7S7144	7S7144CAT	31
7W2398	7W2398CAT	21
7W4487	7W4487CAT	59
7W6081	7W6081CAT	55
7W7488	7W7488CAT	30
8991004	8991004CAT	46
8C5230	8C5230CAT	55
8H2778	8H2778CAT	46
8H9204	8H9204CAT	46
8H9788	8H9788CAT	55
8J-4351	8J4351CAT	55
8L2777	8L2777CAT	55
8L-2779	8L2779CAT	55
8L2786	8L2786CAT	55
8M4445	8M4445CAT	55
8M7145	8M7145CAT	31
8M-8515	8M8515CAT	55
8N1608	8N1608CAT	24
8N5763	8N5763CAT	45
8N7003	8N7003CAT	42
8S9191	8S9191CAT	44

OEM/ MFR No.	Part No.	Page No.
8T-9527	8T9527CAT	55
9L5854	9L5854CAT	22
9L6884	9L6884CAT	44
9L7816	9L7816CAT	41
9L9098	9L9098CAT	44
9M-3786	9M3786CAT	16
9M-4849	9M4849CAT	35
9M6527	9M6527CAT	59
9M7002	9M7002CAT	55
9X6620	9X6620CAT	57
9X7317	9X7317CAT	43
9X7418	9X7418CAT	44
9X7419	9X7419CAT	44
9X7430	9X7430CAT	43
9X7722	9X7722CAT	55
9X7735	9X7735CAT	44
9Y1979	9Y1979CAT	56
9Y2588	9Y2588CAT	14
9Y3368	9Y3368CAT	22
9Y7212	9Y7212CAT	23
9Y7735G	9Y7735GCAT	20
9Y9497G	9Y9497GCAT	21
9Y9889	9Y9889CAT	23
CB399014	CB399014CAT	29
MCBC15093	MCBC15093CAT	28
RW1194PX	RW1194PXM1DRMAN	15
RW6012RX	RW6012RXM1DRMAN	15
9X7418	9X7418CAT	44

The parts listed in this catalog are representative of the engine parts available, but not all inclusive of current and/ or future offerings.

PART NUMBER INDEX

1082	38, 47	1105800	23, 48	1555619	40, 49
1083	38, 47	1118010	13	1609874	21, 49
2299	39	1142687	48	1615719	15
2411	38, 51	1143364	59	1632478	27, 49
7671	37	1144427	48	1656170	32, 58
12246	37	1152367	26	1661781	33, 49
12261	37	1152368	26	1662903	50
14087	36	1171385	48	1662904	50
18188	37	1182797	48	1663718	44, 50
18233	37	1193075	13	1669144	33, 50
19229	37	1198784	43, 48	1678126	17
19461	36	1210145	48	1685248	32, 50
19594	11, 50	1227375	27	1687246	24, 58
19654	36	1250434	16, 48	1765749	24, 50
20229	38, 51	1262702	48	1807352	24
25223	37	1262704	48	1853241	50
28343	38	1264935	48	1891814	34, 50
611453	17	1280317	16, 48	1917941	42
612981	32	1292181	48	1917942	42
614421	32	1293948	12, 48	1917943	42
1003652	18	1299452	28, 48	1917944	42
1006178	12, 47	1310510	33	1917945	42
1006920	27, 56	1326663	24	1917946	42
1013125	47	1330125	34	1978418	10, 50
1017788	28	1343761	24	1978419	11, 50
1024613	38	1354925	15	1979322	22
1025939	15	1359819	48	2147566	51
1031800	27	1365716	33	2147568	51
1033020	37	1368882	17	2153198	44, 51
1036045	34, 47	1375541	45	2161252	29, 51
1043560	23, 47	1384611	28, 48	2165582	33
1048585	43, 47	1393550	14, 49	2165583	33
1052508	45	1415787	34	2170752	33
1061792	31, 58	1422329	32	2243246	21
1061793	31, 58	1422329	49	2245122	29, 51
1064159	30, 58	1425867	18, 49	2245797	44, 51
1075769	47	1425868	18, 49	2271204	29, 51
1082102	44, 47	1426217	21, 49	2274239	44, 58
1083612	30, 58	1427072	23, 49	2303728	46
1090072	35, 47	1440480	45	2303728	51
1090077	34, 47	1440480	49	2303775	43, 51
1090078	47	1440481	46, 49	2323679	51
1095313	47	1440482	46, 49	2326652	29, 51
1100004	12, 47	1464229	29, 49	2336984	51
1102220	23, 47	1539653	28, 49	2341866	51

2341874	51	OR4281.....	20	1025939CAT	15
2373800.....	44, 51	OR4281CATR.....	20	1031800CAT	27
2421539	46, 51	OR4337.....	43	1033020JCB	37
2429537	29	OR4337CATR.....	43	1036045CAT	34, 47
2429537	51	OR7205TRP.....	10	1043560CAT	23, 47
2436718	17	OR7579TRP.....	10	1048585CAT	43, 47
2457339	18, 51	OR7653.....	33	1052508CAT	45
2477133	14	OR7653CATR.....	33	1061792CAT	31, 58
2481394	44, 51	OR-8217	15	1061793CAT	31, 58
2485513	13	OR8289.....	43	1064159CAT	30, 58
2486744	29, 51	OR8289CATR.....	43	1075769CAT	47
2531752	17	OR8320.....	20	107-6280.....	47
2644297.....	14	OR8320CATR.....	20	1076280CAT	47
2746851	10, 51	OR8333.....	20	1082102CAT	44, 47
2818261	30	OR8333CATR.....	20	1082JCB	38, 47
2902060.....	29	OR8783.....	43	1083612CAT	30, 58
2974841	46, 51	OR8783CATR.....	43	1083JCB	38, 47
3056843.....	31, 58	OR8913.....	20	1090072CAT	35, 47
3178766	28	OR8913CATR.....	20	1090077CAT	34, 47
3215746	17	OR8915.....	20	1090078CAT	47
5002983.....	12	OR8915CATR.....	20	1095313CAT	47
5002984.....	12	OR-9375.....	25	10R3292.....	33
8991004.....	46	OR9375CATR.....	25	10R3292CATR.....	33
061-8561.....	47	OR9847.....	20	10R4359BR	25
0618561CAT	47	OR9847CATR.....	20	10R4359BRCATR	25
0L1352	56	OS1571	56	10R-5984	25
0L1352CAT	56	OS1571CAT	56	10R5984BRCATR	25
0L2070	56	OS1573	56	10R-5985	25
0L2070CAT.....	56	OS1573CAT	56	10R5985BRCATR	25
OR2694.....	20	OS1588.....	56	10R7155.....	33
OR2694CATR.....	20	OS1588CAT	56	10R7155CATR.....	33
OR2861.....	20	OS1590.....	56	10R8501.....	43
OR2861CATR.....	20	OS1590CAT	56	10R8501CATR.....	43
OR3421	43	OS1591	56	10R8502.....	43
OR3421CATR	43	OS1591CAT	56	10R8502CATR.....	43
OR3423.....	43	OS1594.....	30, 56	1100004CAT	12, 47
OR3423CATR.....	43	OS1594CAT	30, 56	1102220CAT	23, 47
OR3587.....	43	OS1617	57	1105800CAT	23, 48
OR3587CATR.....	43	OS1617CAT.....	57	1118010CAT.....	13
OR3588.....	43	OS1618	57	112-5282.....	48
OR3588CATR.....	43	OS1618CAT	57	1125282CAT	48
OR-3674.....	25	1003652CAT	18	1142687CAT	48
OR3674CATR	25	1006178CAT	12, 47	1143364CAT	59
OR3757	20	1006920CAT	27, 56	1144427CAT	48
OR3757CATR	20	1013125CAT	47	1152367CAT	26
OR3782.....	20	1017788CAT	28	1152368CAT	26
OR3782CATR.....	20	1024610JCB	38	1171385CAT.....	48
OR4120, OR8330, OR8218,		1024613JCB	38	117-8801	48
10R0483.....	15	1024614JCB	38	1178801CAT	48

1182797CAT	48	1440481CAT	46, 49	1979322CAT	22
118-5068.....	48	1440482CAT	46, 49	1979322TRP	22
1185068CAT	48	1464229CAT	29, 49	1A9579	57
1193075CAT	13	148-2903.....	49	1A9579CAT	57
1198784CAT	43, 48	1482903CAT	49	1D4595	30, 57
1210145CAT	48	149-5240.....	49	1D4595CAT	30, 57
122-3772.....	48	1495240CAT	49	1H1023.....	50
1223772CAT	48	1495566MC1FCAT.....	8	1H1023CAT	50
12246JCB	37	1539653CAT	28, 49	1J-9671.....	50
12261JCB	37	1555619CAT	40, 49	1J9671CAT	50
1227375CAT	27	1609874CAT	21, 49	1P436.....	46, 50
1250434CAT	16, 48	1615719CAT.....	15	1P436CAT	46, 50
1262702CAT	48	163-1533.....	38	1S4295.....	11, 50
1262704CAT	48	163-1547.....	38	1S4295CAT	11, 50
1264935CAT	48	1632478CAT	27, 49	1S4810	11, 50
1280317CAT	16, 48	1656170CAT	32, 58	1S4810CAT	11, 50
128-2922	16, 48	1661781CAT.....	33, 49	1S5440.....	30, 58
1282922CAT	16, 48	1662903CAT	50	1S5440CAT	30, 58
1292181CAT	48	1662904CAT	50	1S6595.....	11, 50
1293948CAT	12, 48	1663718CAT	44, 50	1S6595CAT	11, 50
1299452CAT	28, 48	1669144CAT	33, 50	1S7057	50
1310510CATR	33	1678126CAT	17	1S7057CAT	50
1326663CAT	24	1685248CAT	32, 50	1W2636.....	16, 50
1330125CAT	34	1687246CAT	24, 58	1W2636CAT	16, 50
1343761CAT	24, 48	169-7487	50	1W5283	27
1354925CAT	15	1697487CAT.....	50	1W5283CAT	27
135-4928	16	1765749CAT.....	24, 50	1W8922	21
1354928CAT	16	1807352CAT	24	1W8922CAT	21, 50
1359819CAT	48	1807352MC1FCAT	8	1W9168	45
1365716CATR	33	18188JCB	37	1W9168CAT.....	45
136-7226	48	18233JCB	37	1W9169	45
1367226CAT.....	48	1853241CAT	50	1W9169CAT.....	45
136-7227.....	48	1891814CAT	34, 50	20229JCB.....	38, 51
1367227CAT	48	189-9771	24, 50	2038822PR	27, 57
1368882CATR.....	17	1899771CAT	24, 50	2038822PRCAT.....	27, 57
1375541CAT	45	1917941CAT.....	42	2075248PR.....	43
1384611CAT	28, 48	1917942CAT	42	2075248PRCAT.....	43
1393550CAT.....	14, 49	1917943CAT	42	2147566CAT	51
14087JCB	36, 34	1917944CAT	42	2147568CAT	51
1415787CAT.....	49	1917945CAT	42	2153198CAT	44, 51
141-8938.....	10	1917946CAT	42	2161252CAT	29, 51
1418938CAT	10	19229JCB	37	2165582CAT	33
1422329CAT	32, 49	19461JCB	36	2165583CAT	33
1425867CAT	18, 49	19590JCB	38, 50	2170752CAT	33
1425868CAT	18, 49	19594JCB	11, 50	2173673CAT	51
1426217CAT	21, 49	19654JCB	36	2243246CAT	21
1427072CAT	23, 49	1978418CAT	10, 50	2245122CAT	29, 51
143-6505.....	38, 50	1978419CAT	11	2245797CAT	44, 51
1440480CAT	45, 49	1978419CAT	50	2271204CAT	29, 51

2274239CAT	44, 58	2N7174CAT.....	60	4F7387	52
2299JCB	39	2N8204	28, 52	4F7387CAT	34, 52
2303728CAT	46, 51	2N8204CAT.....	28, 52	4F7391	52
2303775CAT	43, 51	2P2817	24	4F7391CAT	52
2323679CAT	51	2P2817CAT	24	4F9029	52
2326652CAT	29, 51	2P2817CAT	52	4F9029CAT	52
2336984CAT	51	2S3770	28, 58	4F-9653.....	46, 52
2341866CAT	51	2S3770CAT	28, 58	4F9653CAT	46, 52
2341874CAT.....	51	2W3815	22	4J5351.....	53
2373800CAT	44, 51	2W3815CAT	22	4J5351CAT	53
2411JCB.....	38, 51	2W459	52	4J-8997.....	53
2421539CAT	46, 51	2W459CAT	52	4J8997CAT	53
2429537CAT	29, 51	3056843CAT.....	31, 58	4K-1388.....	53
2436718CAT	17	3178766CAT.....	28	4K1388CAT	53
2457339CAT	18, 51	3215746CAT.....	17	4N1151	33, 53
2477133CAT	14	3406062MCBCAT	8, 52	4N1151-6.....	32, 53
2481394CAT	44, 51	3406462MCBCAT	9, 52	4N1151-6CAT	32, 53
2485513CAT	13	3406BPMC1FCAT.....	8	4N1151CAT	33, 53
2486744CAT	29, 51	3406SPMC1FCAT.....	8	4N1156.....	14, 53
25223JCB	37	3B1915.....	57	4N1156CAT	14, 53
2531752CAT	17	3B1915CAT	57	4N5893	26
2644297CAT	14	3D-2824	52	4N5893CAT	26
2746851CAT	10, 51	3D2824CAT	52	4N7253	46, 53
2818261CAT	30	3E6772	30, 57	4N7253CAT.....	46, 53
28343JCB	38	3E6772CAT	30, 57	4P2383.....	15
2902060CAT.....	29, 51	3H-1461.....	52	4P2383CAT	15
2974841CAT.....	46, 51	3H1461CAT	52	4P3977	53
2A1538.....	57	3H7654.....	31, 59	4P3977CAT	53
2A1538CAT	57	3H7654CAT	31, 59	4P4797	40
2A3398.....	35, 52	3J1907	44, 52	4P4797TRP	40
2A3398CAT	35, 52	3J1907CAT	44, 52	4S6137	31, 58
2A4429.....	27, 57	3J7354.....	52	4S6137CAT	31, 58
2A4429CAT	27, 57	3J7354CAT	52	4W2430	33
2H2665.....	52	3P-0650.....	52	4W2430CATR	33
2H2665CAT	52	3P-1155.....	52	4W4014	16, 53
2H3750.....	30, 57	3P1155CAT	52	4W4014CAT	16, 53
2H3750CAT	30, 57	3P-1156.....	52	4W5698.....	17
2M-4453.....	52	3P1156CAT	52	4W5698CAT	17
2M4453CAT	52	3P650CAT	52	4W5702	20
2M9780	52	3S9643.....	14, 52	4W5702CAT	20
2M9780CAT	52	3S9643CAT	14, 52	4W7018	44, 57
2N2765.....	11, 57	40764-20.....	34	4W7018CAT	44, 57
2N2765CAT	11, 57	44098-201	35	4Y9652	32, 53
2N2766.....	30, 57	44165-201.....	35	4Y9652CAT	32, 53
2N2766CAT	30, 57	44209-20	35	5002983BXR	12, 12
2N3350	52	471120-0001.....	10	5B0841.....	41, 57
2N3350CAT.....	52	4D3107	52	5B0841TRP	41, 57
2N7174	59	4D3107CAT	52	5E-8771	53
2N7174CAT.....	59	4F7387	34	5E8771CAT.....	53

5H1504.....	31, 59	6V-4589.....	54	7E5665CAT	24, 58
5H1504CAT.....	31, 59	6V4589CAT	54	7J-0204	54
5H7704.....	53	6V5048.....	54	7J204CAT.....	54
5H7704CAT.....	53	6V5048CAT	54	7L6580	54
5M2894.....	31, 59	6V-5050.....	54	7L6580CAT	54
5M2894CAT	31, 59	6V5050CAT	54	7M4843.....	57
5P1075.....	59	6V-5063.....	54	7M4843CAT.....	57
5P1075CAT	59	6V5063CAT	54	7M7219	45
5P-4889.....	53	6V5134	54	7M7219CAT	45
5P4889CAT	53	6V5134CAT	54	7N7078.....	24, 54
5P5678-30	29, 53	6V5266.....	54	7N7078CAT.....	24, 54
5P5678-30CAT.....	29, 53	6V5266CAT	54	7S3206.....	46, 55
5P5846.....	35, 53	6V5759	54	7S3206CAT.....	46, 55
5P5846CAT	35, 53	6V5759CAT	54	7S7144	31, 58
5P-7701.....	53	6V-6228.....	54	7S7144CAT	31, 58
5P7701CAT	53	6V6228CAT	54	7W2398.....	21, 55
5P7814	53	6V-6353.....	54	7W2398CAT	21, 55
5P7814CAT	53	6V6353CAT	54	7W4487	59
5P8068.....	35, 53	6V6609.....	54	7W4487CAT	59
5P8068CAT.....	35, 53	6V6609CAT	54	7W6081	55
5P-8211	53	6V7350.....	54	7W6081CAT	55
5P8211CAT	53	6V7350CAT	54	7W7488	30, 58
5P8356.....	53	6V-8397.....	54	7W7488CAT	30, 58
5P8356CAT	53	6V8397CAT	54	8991004CAT	46
5P8768.....	21, 53	6V-8398.....	54	8C5230.....	55
5P8768CAT	21, 53	6V8398CAT	54	8C5230CAT.....	55
5R7137	59	6V-9027	54	8H2778.....	46, 55
5R7137CAT	59	6V9027CAT	54	8H2778CAT	46, 55
611453CAT	17	6V9746	54	8H9204.....	46, 59
612981CAT	32	6V9746CAT.....	54	8H9204CAT.....	46, 59
614421CAT	32	714508-0003	10	8H9788.....	55
6J-2245	53	7671JCB.....	37	8H9788CAT	55
6J2245CAT.....	53	7C1728.....	18, 54	8J-4351.....	55
6L8562	31, 58	7C1728CAT	18, 54	8J4351CAT	55
6L8562CAT	31, 58	7C3039.....	34	8L2777	55
6N2985	35	7C3039CAT	34	8L2777CAT.....	55
6N2985CAT.....	35	7C3095KTCAT	13	8L-2779	55
6N8942.....	22, 57	7C8296.....	30, 57	8L2779CAT.....	55
6N8942CAT.....	22, 57	7C8296CAT	30, 57	8L2786	55
6V1197	53	7C9222.....	15	8L2786CAT.....	55
6V1197CAT.....	53	7C9222CAT	15	8M4445.....	55
6V1903	54	7E1177	24, 58	8M4445CAT	55
6V1903CAT	54	7E1177CAT.....	24	8M7065.....	12
6V-3319	54	7E1177CAT.....	58	8M7065CAT	12
6V3319CAT	54	7E292CAT	23	8M7065CAT	55
6V-3348.....	54	7E4195	22, 57	8M7145	31, 59
6V3348CAT	54	7E4195CAT.....	22, 57	8M7145CAT	31, 59
6V-3834.....	54	7E5665.....	24	8M-8515.....	55
6V3834CAT	54	7E5665.....	58	8M8515CAT	55

8N1608.....	24, 58	9Y7212CAT.....	23
8N1608CAT.....	24, 58	9Y7735.....	20
8N1985.....	22	9Y7735GCAT.....	20
8N1985CAT.....	22	9Y9497.....	21
8N5763.....	45, 55	9Y9497GCAT.....	21
8N5763CAT.....	45, 55	9Y9889.....	23
8N7003.....	42	9Y9889CAT.....	23
8N7003CAT.....	42	CB3406113CAT.....	29, 56
8S9191.....	44, 57	CB3406273CAT.....	29, 56
8S9191CAT.....	44, 57	CB399014.....	29, 56
8T-9527.....	55	CB399014CAT.....	29, 56
8T9527CAT.....	55	CK1175063PCAT.....	19
9L5854.....	22, 55	CK1807352PCAT.....	23
9L5854CAT.....	22, 55	CK2900017PCAT.....	19
9L6884.....	44, 57	GK3-1A.....	60
9L6884CAT.....	44, 57	M4N1151-6CAT.....	35, 56
9L7816.....	41, 57	MCOH1807352.....	9
9L7816CAT.....	41, 57	MCOH3406BP.....	9
9L9098.....	44, 55	MC1F7C2888CAT.....	8
9L9098CAT.....	44, 55	MCB3406463CAT.....	29, 56
9M-3786.....	16, 55	MCB3406473CAT.....	29, 56
9M3786CAT.....	16, 55	MCB3406ESKCAT.....	31, 58
9M-4849.....	35, 55	MCB3406SKCAT.....	31, 58
9M4849CAT.....	35, 55	MCBC15093.....	28, 56
9M6527.....	59	MCBC15093CAT.....	28, 56
9M6527CAT.....	59	MRS3406E2CAT.....	24, 56
9M7002.....	55	P39010.....	36
9M7002CAT.....	55	RW1194PXM1DRMAN.....	15
9X6620.....	57	RW6012RXM1DRMAN.....	15, 15
9X6620CAT.....	57	RW6014XM1DRMAN.....	15
9X7317.....	43, 55		
9X7317CAT.....	43, 55		
9X7418.....	44, 55		
9X7418CAT.....	44, 55		
9X7419.....	44		
9X7419CAT.....	44		
9X7430.....	43, 55		
9X7430CAT.....	43, 55		
9X7722.....	55		
9X7722CAT.....	55		
9X7735.....	44, 55		
9X7735CAT.....	44, 55		
9Y1979.....	56		
9Y1979CAT.....	56		
9Y2588.....	14, 56		
9Y2588CAT.....	14, 56		
9Y3368.....	22		
9Y3368CAT.....	22		
9Y7212.....	23		

SUBJECT INDEX

A

Air Management Components 10

C

Cooling System Components..... 13

Crankshafts & Components 17

Cylinder Components..... 19

Cylinder Heads & Components..... 25

E

Engine Blocks & Components..... 32

Engine Brakes & Components 36

Engine Flywheels 40

Engine Parts..... 47

F

Fuel System Components..... 42

N

Natural Gas Engine Components 60

O

Overhaul Kits..... 8

TABLES

Overhaul Kits

Table 1: Inframe Kits.....	8
Table 2: Gaskets, Rings & Seals.....	8
Table 3: Overhaul Kits.....	9

Air Management Components

Table 4: Turbochargers - New.....	10
Table 5: Turbochargers - Reman.....	10
Table 6: Gaskets, Rings & Seals.....	10
Table 7: Hardware.....	11
Table 8: Air Compressors - Reman.....	12
Table 9: Gaskets, Rings & Seals.....	12

Cooling System Components

Table 10: Thermostat Kits.....	13
Table 11: Thermostats - New.....	13
Table 12: Regulators.....	14
Table 13: Sensors.....	14
Table 14: Gaskets, Rings & Seals.....	14
Table 15: Water Pumps - New.....	15
Table 16: Water Pumps - Reman.....	15
Table 17: Adapters.....	15
Table 18: Shafts.....	16
Table 19: Gaskets, Rings & Seals.....	16

Crankshafts & Components

Table 20: Crankshafts - Reman.....	17
Table 21: Dampers.....	17
Table 22: Bearings.....	17
Table 23: Gaskets, Rings & Seals.....	18
Table 24: Hardware.....	18

Cylinder Components

Table 25: Cylinder Kits.....	19
Table 26: Cylinder Packs.....	20
Table 27: Bearings.....	20
Table 28: Gaskets, Rings & Seals.....	21
Table 29: Bearings.....	21
Table 30: Bushings.....	22
Table 31: Hardware.....	22
Table 32: Liners.....	22
Table 33: Inserts.....	22
Table 34: Gaskets, Rings & Seals.....	22
Table 35: Piston Kits.....	23
Table 36: Pistons.....	23
Table 37: Crowns.....	24

Table 38: Skirts.....	24
Table 39: Gaskets, Rings & Seals.....	24
Table 40: Hardware.....	24

Cylinder Heads & Components

Table 41: Cylinder Heads - Reman.....	25
Table 42: Intake Valves.....	26
Table 43: Exhaust Valves.....	26
Table 44: Inserts.....	26
Table 45: Valve Guides.....	27
Table 46: Gaskets, Rings & Seals.....	27
Table 47: Hardware.....	27
Table 48: Adapters.....	27
Table 49: Bearings.....	28
Table 50: Lifters.....	28
Table 51: Gaskets, Rings & Seals.....	28
Table 52: Hardware.....	30

Engine Blocks & Components

Table 53: Plates.....	32
Table 54: Plugs.....	32
Table 55: Gaskets, Rings & Seals.....	32
Table 56: Camshafts - Reman.....	33
Table 57: Bushings.....	33
Table 58: Gaskets, Rings & Seals.....	34
Table 59: Oil Coolers - New.....	34
Table 60: Gaskets, Rings & Seals.....	34
Table 61: Dipsticks.....	34
Table 62: Filler Caps.....	35
Table 63: Gaskets, Rings & Seals.....	35
Table 64: Gaskets, Rings & Seals.....	35
Table 65: Gaskets, Rings & Seals.....	35

Engine Brakes & Components

Table 66: Tune Up Kits.....	36
Table 67: Exhaust Brakes.....	37
Table 68: Housings.....	37
Table 69: Push Rods.....	37
Table 70: Switches.....	37
Table 71: Gaskets, Rings & Seals.....	38
Table 72: Solenoids.....	38
Table 73: Air Cylinders.....	38
Table 74: Terminals.....	39

Engine Flywheels

Table 75: Flywheels.....	40
Table 76: Gaskets, Rings & Seals.....	40
Table 77: Hardware	41

Fuel System Components

Table 78: Injector Assemblies.....	42
Table 79: Injectors - New.....	42
Table 80: Injectors - Reman	43
Table 81: Injector Kits.....	43
Table 82: Gaskets, Rings & Seals.....	43
Table 83: Hardware	44
Table 84: Fuel Pumps.....	45
Table 85: Bearings.....	45
Table 86: Gaskets, Rings & Seals.....	45
Table 87: Clamps.....	45
Table 88: Gaskets, Rings & Seals.....	46
Table 89: Hardware	46

Engine Parts

Table 90: Gaskets, Rings & Seals.....	47
Table 91: Hardware	56

Natural Gas Engine Components

Table 92: Spark Plugs	60
Table 93: Hardware	60

Cross Reference

Table 94: Cross Reference.....	61
--------------------------------	----

NOTES

CATERPILLAR
3406

A large rectangular area filled with a light blue grid pattern, intended for handwritten notes. The grid consists of approximately 25 columns and 35 rows of small squares.

NOTES

A large rectangular area filled with a light blue grid pattern, intended for handwritten notes. The grid consists of approximately 25 columns and 35 rows.

CATERPILLAR
3406



*For information, updates, or corrections,
please contact us at feedback@TRPParts.com*

*No part of this marketing material may be
reproduced in any manner without written
permission from TRP® North America.*

TRP® North America

750 Houser Way N.
Renton, WA 98057

www.trpparts.com